

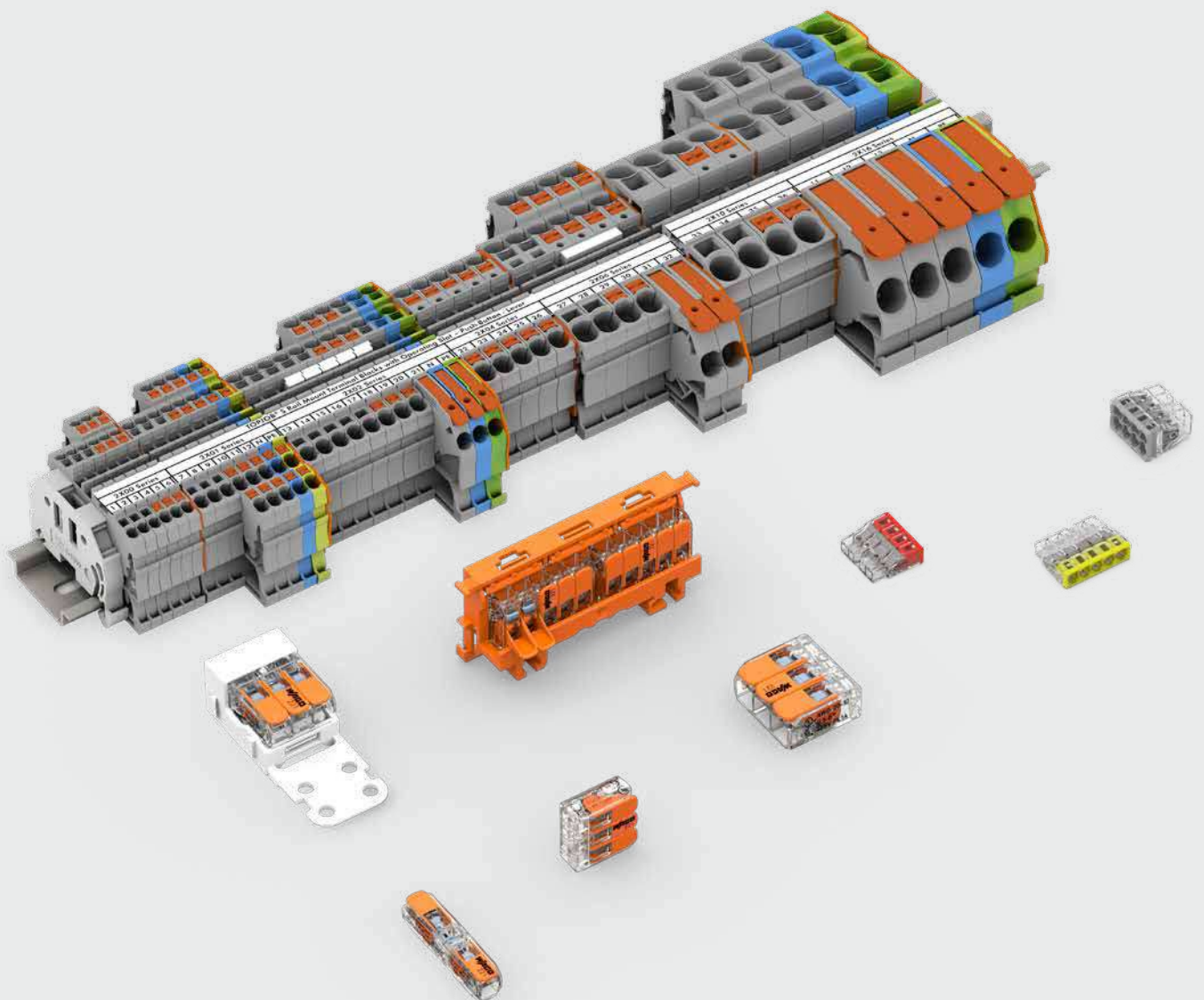

WAGO Rail-Mount Terminal Blocks and Connectors

Edition 2023/2024



WAGO Full Line Catalogs



WAGO Rail-Mount Terminal Blocks and Connectors

- Rail-Mount Terminal Blocks
- Rail-Mount Terminal Blocks with Pluggable Connector (X-COM®-SYSTEM)
- Patchboard Systems
- Terminal Strips
- PUSH WIRE® Connectors for Junction Boxes
- Lighting Connectors
- Shield Connecting System



WAGO PCB Terminal Blocks and Connectors

- PCB Terminal Blocks
- THR/SMD PCB Terminal Blocks
- *MULTI CONNECTION SYSTEM (MCS)*
- Pluggable PCB Terminal Blocks
- Feedthrough Terminal Blocks
- Specialty Connectors
- Empty Housings



WAGO Pluggable Connection System WINSTA®

- Pluggable Connectors
- Snap-In Device Connectors
- Pluggable PCB Connectors
- Distribution Connectors
- Cable Assemblies
- Flat Cable Systems
- Distribution Boxes



WAGO Automation Technology

- Solutions & Software
- Operating & Monitoring
- Controllers, Edge Devices
- Modular I/O-SYSTEM IP20, I/O-SYSTEM IP67
- Industrial Switches
- Radio Technology
- IP67 Sensor/Actuator Boxes, IP67 Cables and Connectors



WAGO Interface Electronics

- Relay and Optocoupler Modules
- Signal Conditioners and Isolation Amplifiers
- Current and Energy Measurement Technology
- Power Supplies
- Interface Modules and System Wiring
- Overvoltage Protection
- Empty Housings



WAGO Power Supplies

- Power Supplies
- DC/DC Converters
- Circuit Protection
- UPS-Charger and Capacitive Buffer Modules
- Redundancy Moduls
- Current and Energy Measurement Technology
- Overvoltage Protection

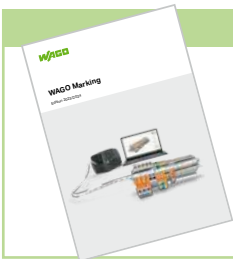

WAGO Marking

- Printer
- Software
- Terminal Block Marking
- Cable and Conductor Marking
- Device Marking
- Marker Carriers

WAGO Rail-Mount Terminal Blocks and Connectors

			Page	
	WAGO Rail-Mount Terminal Blocks TOPJOB® S Front-Entry Wiring	Push-in CAGE CLAMP® 1 ... 16 (25 "f-st") mm ² / 16 ... 4 AWG for DIN-35 rail	23	1
	WAGO Rail-Mount Terminal Blocks with a Pluggable Connector X-COM®S-SYSTEM Front-Entry Wiring	Push-in CAGE CLAMP® 1 ... 2.5 (4) mm ² / 16 ... 12 AWG for DIN-35 rail	191	2
	WAGO Installation Rail-Mount Terminal Blocks TOPJOB® S Front-Entry Wiring	Push-in CAGE CLAMP® 1 ... 4 (6) mm ² / 16 ... 10 AWG for DIN-35 rail	237	3
	WAGO Miniature Rail-Mount Terminal Blocks TOPJOB® S Front-Entry Wiring	Push-in CAGE CLAMP® 0.14 ... 1 (1.5) mm ² / 24 ... 16 AWG for DIN-35 rail	279	4
	WAGO High-Current Rail-Mount Terminal Blocks Side-Entry Wiring	POWER CAGE CLAMP 35 ... 185 mm ² / 2 AWG ... 350 kcmil, 1500 V nominal voltage, for DIN-35 rail	295	5
	WAGO Rail-Mount Terminal Blocks "Classic" WAGO Installation Rail-Mount Terminal Blocks TOPJOB® "Classic" Front-Entry Wiring	CAGE CLAMP® 1.5 ... 35 mm ² / 16 ... 2 AWG for DIN-35 rail	309	6
	WAGO Rail-Mount Terminal Blocks with a Pluggable Connector X-COM®-SYSTEM Front-Entry Wiring	CAGE CLAMP® 2.5 (4) mm ² / 12 AWG for DIN-35 rail	429	7
	WAGO Rail-Mount Terminal Blocks "Mini" WAGO Rail-Mount Terminal Blocks "Compact" Front-Entry Wiring	CAGE CLAMP® 2.5 mm ² (4 mm ²) / 12 AWG for DIN-35 and DIN-15 rails	501	8
	WAGO Modular Terminal Blocks and WAGO Terminal Strips Side-/Front-Entry Wiring	CAGE CLAMP® 1.5 ... 4 mm ² / 16 ... 12 AWG for panel mounting	525	9
	WAGO Chassis-Mount Terminal Strips WAGO Field-Wiring Terminal Blocks Side-Entry Wiring	Push-in CAGE CLAMP® 2.5 mm ² / 22 AWG, 4 mm ² / 12 AWG for panel mounting	555	10
	WAGO Rail-Mount Terminal Blocks "Classic" Side-Entry Wiring	CAGE CLAMP® 1.5 ... 16 mm ² / 16 ... 6 AWG for DIN-35 rail	577	11
	WAGO Patchboard Systems WAGO Busbar Terminal Blocks	CAGE CLAMP® 1.5 ... 16 mm ² / 16 ... 6 AWG	589	12
	WAGO Splicing Connectors WAGO Lighting Connectors		613	13
	WAGO Accessories and WAGO Tools		665	14
	Technical Section		727	15
	Indexes Current addresses at www.wago.com		779	16

Product Overview

WAGO Rail-Mount Terminal Blocks TOPJOB® S; with Push-in CAGE CLAMP® Connection

Through terminal blocks; with lever and Push-in CAGE CLAMP®



Page 26

Ground conductor terminal blocks; with lever and Push-in CAGE CLAMP®



Page 26

Through terminal blocks; with lever and push-button



Page 31

WAGO Rail-Mount Terminal Blocks TOPJOB® S; with Push-in CAGE CLAMP® Connection

Ground conductor terminal blocks; with lever and push-button



Page 31

Through terminal blocks; with push-button



Page 36

Ground conductor terminal blocks; with push-button



Page 36

WAGO Rail-Mount Terminal Blocks TOPJOB® S; with Push-in CAGE CLAMP® Connection

Through terminal blocks



Page 52

Ground conductor terminal blocks



Page 52

Shield terminal blocks



Page 54

WAGO Rail-Mount Terminal Blocks TOPJOB® S; with Push-in CAGE CLAMP® Connection

Double-potential terminal blocks

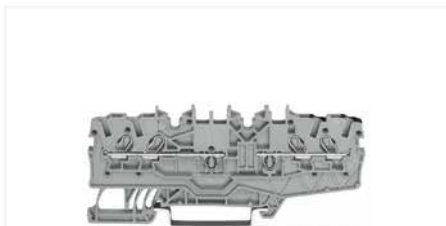

Page 53

Distribution terminal block; with push-button



Page 66

Distribution terminal block

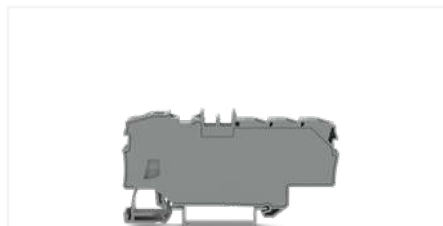

Page 67

Product Overview

WAGO Rail-Mount Terminal Blocks TOPJOB® S; with Push-in CAGE CLAMP® Connection

Double-deck terminal blocks; with push-button



Page 70

Double-deck terminal blocks



Page 72

Double-deck disconnect terminal blocks



Page 86

WAGO Rail-Mount Terminal Blocks TOPJOB® S; with Push-in CAGE CLAMP® Connection

Double-deck carrier terminal blocks



Page 86

Double-deck fuse terminal blocks

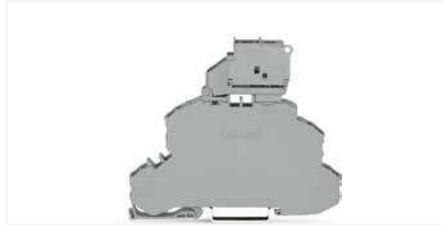

Page 87

Triple-deck terminal block; with push-button



Page 88

WAGO Rail-Mount Terminal Blocks TOPJOB® S; with Push-in CAGE CLAMP® Connection

Triple-deck terminal blocks



Page 90

Quadruple-deck rail-mount terminal blocks as rail-mount terminal blocks for electric motor wiring



Page 92

Disconnect and test terminal blocks; with push-button



Page 94

WAGO Rail-Mount Terminal Blocks TOPJOB® S; with Push-in CAGE CLAMP® Connection

Fuse terminal blocks; with push-button; for mini-automotive blade-style fuse



Page 94

Fused disconnect terminal blocks with a pivoting fuse holder; with push-button

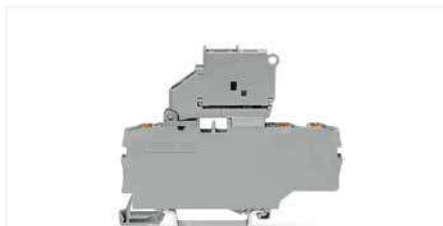

Page 104

Through terminal blocks; with push-button



Page 95

Product Overview

WAGO Rail-Mount Terminal Blocks TOPJOB® S; with Push-in CAGE CLAMP® Connection

Disconnect and test terminal blocks



Page 106

Fuse terminal blocks for mini-automotive blade-style fuses



Page 106

Fused disconnect terminal blocks with a pivoting fuse holder for glass cartridge fuses

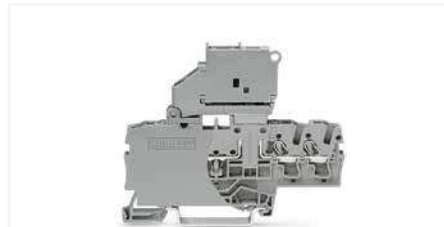

Page 116

WAGO Rail-Mount Terminal Blocks TOPJOB® S; with Push-in CAGE CLAMP® Connection

Through terminal blocks



Page 109

Ground conductor disconnect terminal blocks

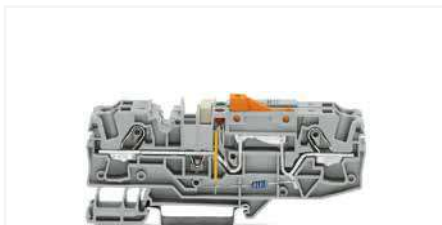

Page 116

Ground conductor disconnect terminal blocks; with push-button

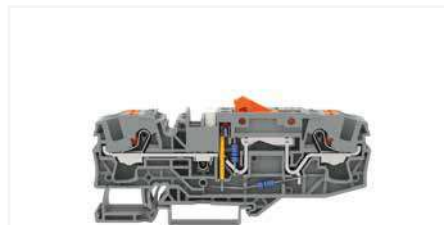

Page 118

WAGO Rail-Mount Terminal Blocks TOPJOB® S; with Push-in CAGE CLAMP® Connection

Carrier terminal blocks; with push-button



Page 94

Carrier terminal blocks



Page 107

Fuse plugs on carrier terminal blocks



Page 140

WAGO Rail-Mount Terminal Blocks TOPJOB® S; with Push-in CAGE CLAMP® Connection

Terminal Blocks Assembly; for Current and Voltage Transformers



Page 138

Sensor and actuator terminal blocks

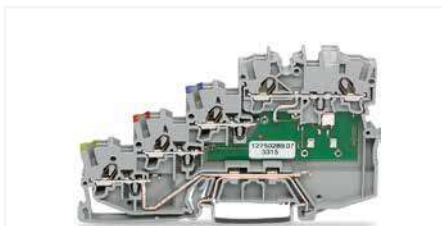

Page 146

Sensor and actuator terminal blocks; with a pluggable signal level



Page 151

Product Overview

WAGO Rail-Mount Terminal Blocks TOPJOB® S; with Push-in CAGE CLAMP® Connection

Diode terminal blocks



Page 154

LED terminal blocks



Page 154

Empty component plug housings



Page 161

WAGO Rail-Mount Terminal Blocks TOPJOB® S; with Push-in CAGE CLAMP® Connection

Diode modules



Page 160

LED modules



Page 162

Component plugs



Page 166

WAGO Rail-Mount Terminal Blocks TOPJOB® S; with Push-in CAGE CLAMP® Connection

Double-deck disconnect/test terminal blocks



Page 168

Double-deck carrier terminal blocks

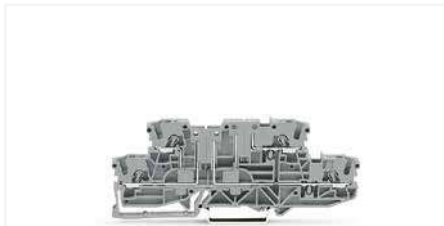

Page 170

Multilevel diode terminal blocks and LED terminal blocks



Page 172

WAGO Rail-Mount Terminal Blocks with a Pluggable Connector, X-COM®S-SYSTEM-MINI

Carrier terminal blocks



Page 194

Ground carrier terminal blocks



Page 194

Double-deck carrier terminal blocks



Page 196

Product Overview

WAGO Rail-Mount Terminal Blocks with a Pluggable Connector, X-COM®S-SYSTEM-MINI

1-conductor female plugs

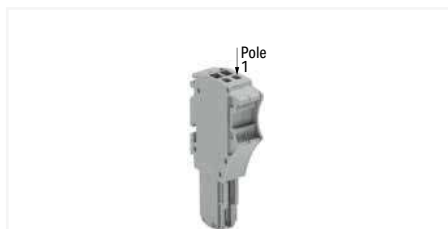

Page 198

2-conductor female plugs

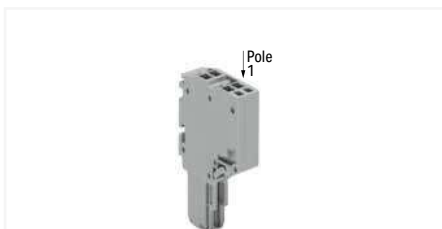

Page 198

Female plugs for self-assembly



Page 200

WAGO Rail-Mount Terminal Blocks with a Pluggable Connector, X-COM®S-SYSTEM-MINI

Pre-assembled female plugs

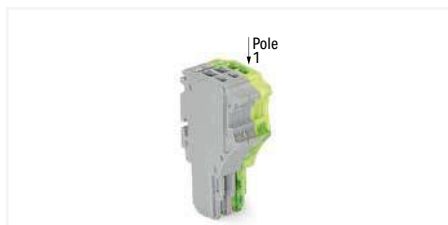

Page 202

1-conductor female plugs; with locking levers and strain relief plates

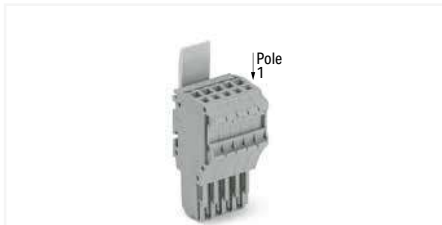

Page 206

2-conductor female plugs; with locking levers and strain relief plates

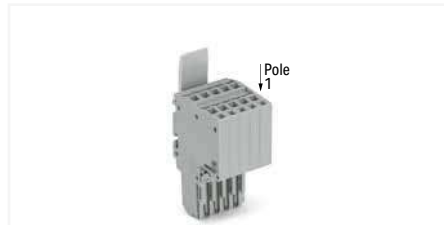

Page 208

WAGO Rail-Mount Terminal Blocks with a Pluggable Connector, X-COM®S-SYSTEM

Carrier terminal blocks; with push-button



Page 210

Carrier terminal blocks



Page 212

Ground carrier terminal blocks



Page 212

WAGO Rail-Mount Terminal Blocks with a Pluggable Connector, X-COM®S-SYSTEM

Carrier terminal blocks



Page 214

Double-deck carrier terminal blocks



Page 216

Female plugs



Page 218

Product Overview

WAGO Rail-Mount Terminal Blocks with a Pluggable Connector, X-COM®S-SYSTEM

Female plugs for self-assembly

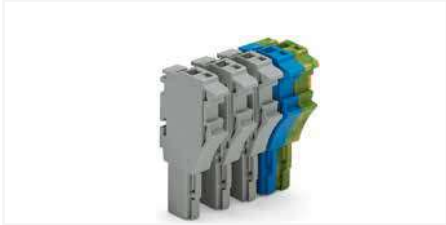

Page 220

Pre-assembled female plugs

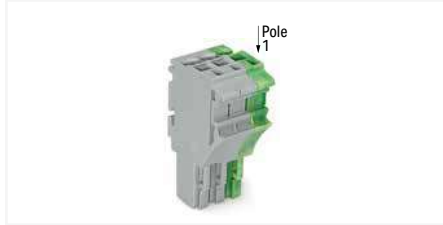

Page 222

Female plugs; with locking levers and strain relief plates

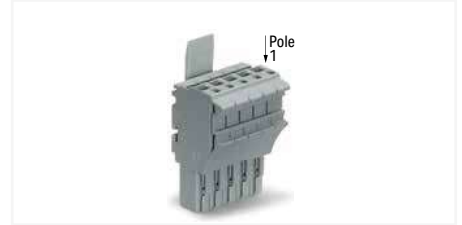

Page 224

WAGO Rail-Mount Terminal Blocks with a Pluggable Connector, X-COM®S-SYSTEM; for Ex applications

Carrier terminal blocks; with push-button; for Ex ec applications



Page 226

Carrier terminal blocks; for Ex ec applications

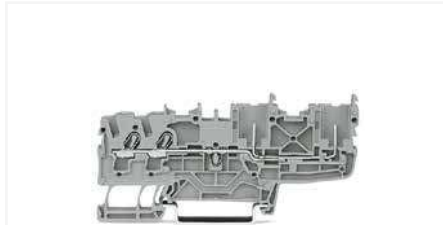

Page 228

Ground carrier terminal blocks; for Ex ec applications



Page 228

WAGO Rail-Mount Terminal Blocks with a Pluggable Connector, X-COM®S-SYSTEM; for Ex applications

Double-deck carrier terminal blocks; for Ex ec applications

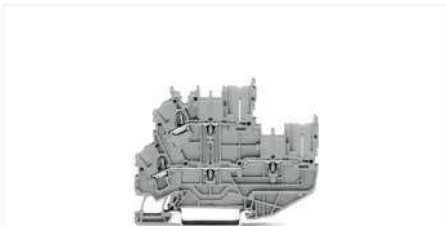

Page 232

Female plugs; for Ex ec applications

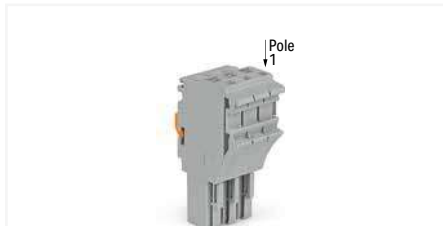

Page 234

Pre-assembled female plugs; for Ex ec applications

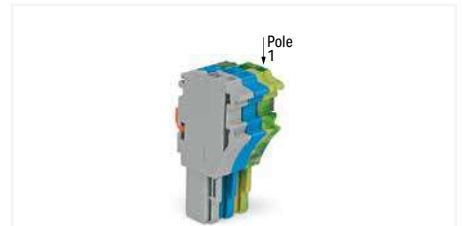

Page 235

WAGO Installation Rail-Mount Terminal Blocks TOPJOB® S; with Push-in CAGE CLAMP® Connection

Multilevel installation terminal blocks; with operating slot and push-button



Page 240

Multilevel installation terminal blocks; with push-button



Page 252

Multilevel installation terminal blocks; with an N-disconnect slide link; 2.5 (4) mm²



Page 256

Product Overview

WAGO Installation Rail-Mount Terminal Blocks TOPJOB® S; with Push-in CAGE CLAMP® Connection

Multilevel installation terminal blocks; with an internal N-disconnection

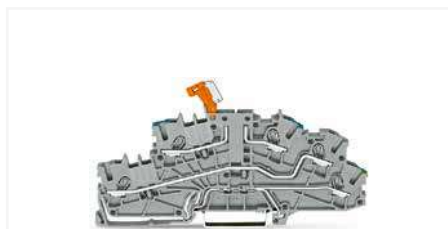

Page 258

Multilevel installation terminal blocks; with an N-disconnect slide link; 4 (6) mm² (10 AWG)



Page 264

Double-fuse plugs



Page 262

WAGO Installation Rail-Mount Terminal Blocks TOPJOB® S; with Push-in CAGE CLAMP® Connection

N-conductor disconnect terminal blocks and power distribution disconnect terminal blocks; with push-button



Page 266

N-conductor disconnect terminal blocks and power distribution disconnect terminal blocks



Page 268

Supply Terminal Block for Distribution Boxes



Page 270

WAGO Installation Rail-Mount Terminal Blocks TOPJOB® S; with Push-in CAGE CLAMP® Connection

Mminiature through terminal blocks; with push-button; for DIN-15 rail



Page 282

Mminiature ground conductor terminal blocks; with push-button; for DIN-15 rail



Page 282

Mminiature through terminal blocks; with push-button; with mounting flange or snap-in mounting foot



Page 286

WAGO Installation Rail-Mount Terminal Blocks TOPJOB® S; with Push-in CAGE CLAMP® Connection

Mminiature through terminal blocks; with push-button; for DIN-15 rail



Page 284

Mminiature ground conductor terminal blocks; with push-button; for DIN-15 rail



Page 284

Mminiature through terminal blocks; with push-button; with mounting flange or snap-in mounting foot



Page 286

Product Overview

WAGO High-Current Rail-Mount Terminal Blocks

Through terminal blocks; 35 mm² (2 AWG)



Page 298

Ground conductor terminal blocks; 35 mm² (2 AWG)



Page 298

Power taps; for high-current terminal blocks 35 mm² (2 AWG)



Page 298

WAGO High-Current Rail-Mount Terminal Blocks

Through terminal blocks; 50 mm² (1/0 AWG)



Page 302

Ground conductor terminal blocks; 50 mm² (1/0 AWG)



Page 302

Through terminal blocks with mounting flanges; 50 mm² (1/0 AWG)



Page 303

WAGO High-Current Rail-Mount Terminal Blocks

Through terminal blocks; 95 mm² (4/0 AWG)



Page 304

Ground conductor terminal blocks; 95 mm² (4/0 AWG)



Page 304

Through terminal blocks with mounting flanges; 95 mm² (4/0 AWG)



Page 305

WAGO High-Current Rail-Mount Terminal Blocks

Through terminal blocks; 185 mm² (350 kcmil)



Page 306

Ground conductor terminal blocks; 185 mm² (350 kcmil)



Page 306

Through terminal blocks with mounting flanges; 185 mm² (350 kcmil)



Page 307

Product Overview

WAGO High-Current Rail-Mount Terminal Blocks

Power taps; for high-current terminal blocks 50 mm² (1/0 AWG)



Page 302

Power taps; for high-current terminal blocks 95 mm² (4/0 AWG)



Page 304

Power taps; for high-current terminal blocks 185 mm² (350 kcmil)



Page 306

WAGO Rail-Mount Terminal Blocks, Classic; with CAGE CLAMP® Connection

Through terminal blocks



Page 312

Ground conductor terminal blocks



Page 312

Shield terminal blocks



Page 312

WAGO Rail-Mount Terminal Blocks, Classic; with CAGE CLAMP® Connection

Double-potential terminal blocks



Page 313

Distribution terminal blocks



Page 340

Double-deck terminal blocks



Page 328

WAGO Rail-Mount Terminal Blocks, Classic; with CAGE CLAMP® Connection

Triple-deck terminal blocks

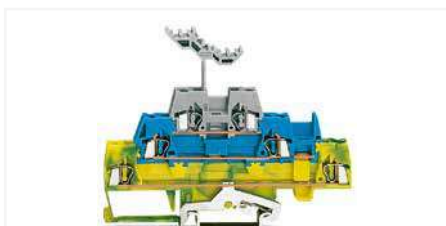

Page 338

Quadruple-deck rail-mount terminal blocks as rail-mount terminal blocks for electric motor wiring



Page 340

Double- and triple-deck carrier terminal blocks; for fuse plug



Page 334

Product Overview

WAGO Rail-Mount Terminal Blocks, TOPJOB® Classic; with CAGE CLAMP® Connection

Through terminal blocks



Page 343

Ground conductor terminal blocks



Page 343

N-conductor disconnect terminal blocks and power distribution disconnect terminal blocks



Page 347

WAGO Rail-Mount Terminal Blocks, Classic; with CAGE CLAMP® Connection

Disconnect and test terminal blocks



Page 352

Disconnect and test terminal blocks



Page 354

Disconnect/test terminal blocks; for current and voltage transformer circuits

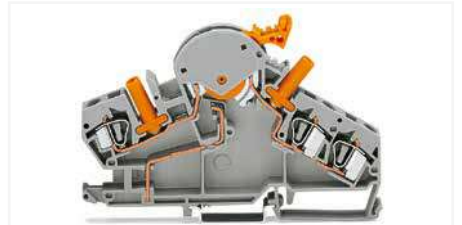

Page 362

WAGO Rail-Mount Terminal Blocks, Classic; with CAGE CLAMP® Connection

Ground conductor disconnect terminal blocks

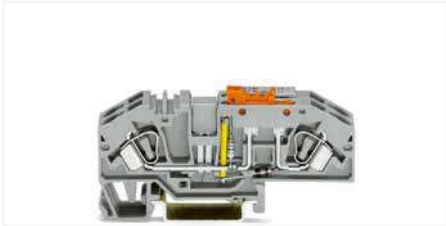

Page 368

Fuse terminal blocks for mini-automotive blade-style fuses

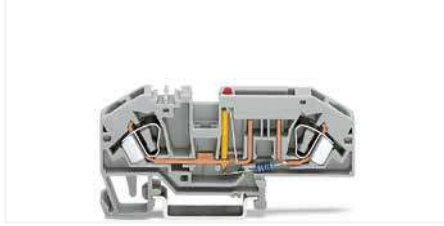

Page 370

Fused disconnect terminal blocks with a pivoting fuse holder for glass cartridge fuses



Page 374

WAGO Rail-Mount Terminal Blocks, Classic; with CAGE CLAMP® Connection

Fuse terminal blocks; for Class CC fuses and 10 x 38 mm (1 1/2" x 1 1/2") cylindrical fuses



Page 382

Fuse plugs on carrier terminal blocks



Page 378

Sensor and actuator terminal blocks



Page 390

Product Overview

WAGO Rail-Mount Terminal Blocks, Classic; with CAGE CLAMP® Connection

Diode terminal blocks



Page 406

LED terminal blocks



Page 406

Multilevel diode terminal blocks and LED terminal blocks



Page 412

WAGO Rail-Mount Terminal Blocks, Classic; with CAGE CLAMP® Connection

Diode modules



Page 416

LED modules



Page 418

WAGO Rail-Mount Terminal Blocks with a Pluggable Connector, X-COM®-SYSTEM

Carrier terminal blocks

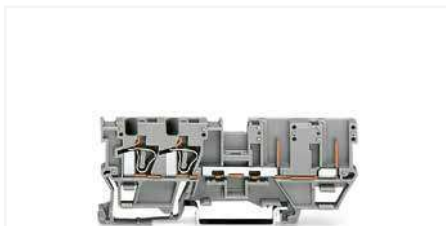

Page 436

Ground carrier terminal blocks



Page 436

Disconnect carrier terminal blocks



Page 448

WAGO Rail-Mount Terminal Blocks with a Pluggable Connector, X-COM®-SYSTEM

Diode carrier terminal blocks

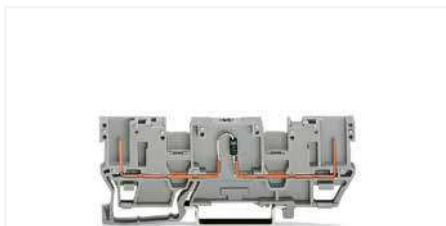

Page 448

LED carrier terminal blocks



Page 450

Carrier terminal blocks; for pluggable modules

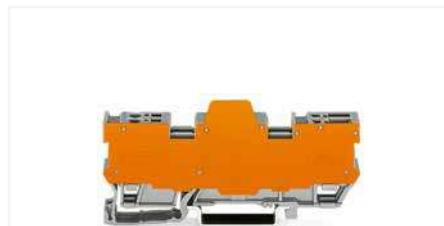

Page 458

Product Overview

WAGO Rail-Mount Terminal Blocks with a Pluggable Connector, X-COM®-SYSTEM

Double-deck carrier terminal blocks



Page 466

Male connectors; with CAGE CLAMP® connection



Page 476

Male headers; with solder pins



Page 480

WAGO Rail-Mount Terminal Blocks with a Pluggable Connector, X-COM®-SYSTEM

Female plugs; with/without lateral locking lever



Page 486

Female plugs for self-assembly



Page 490

Pre-assembled female plugs

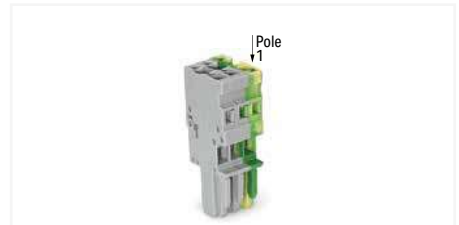

Page 492

WAGO Rail-Mount Terminal Blocks, Mini; with CAGE CLAMP® Connection

Through terminal blocks; for DIN-35 rail



Page 504

Ground conductor terminal blocks; for DIN-35 rail



Page 504

Through terminal blocks Ex e II; for DIN-35 rail



Page 504

WAGO Rail-Mount Terminal Blocks, Mini; with CAGE CLAMP® Connection

Through terminal blocks; for DIN-15 rail



Page 505

Ground conductor terminal blocks; for DIN-15 rail



Page 505

Through terminal blocks Ex e II; for DIN-15 rail



Page 505

Product Overview

WAGO Rail-Mount Terminal Blocks, Compact; with CAGE CLAMP COMPACT Connection

Through terminal blocks; for DIN-35 rail



Page 508

Ground conductor terminal blocks; for DIN-35 rail



Page 508

Through terminal blocks Ex e II; for DIN-15 rail



Page 508

WAGO Rail-Mount Terminal Blocks, Compact; with CAGE CLAMP COMPACT Connection

Through terminal blocks; for DIN-15 rail



Page 509

Ground conductor terminal blocks; for DIN-15 rail



Page 509

Through terminal blocks Ex e II; for DIN-15 rail



Page 509

WAGO Rail-Mount Terminal Blocks, Compact; with CAGE CLAMP COMPACT Connection

Double-potential terminal blocks



Page 509

Double-deck terminal blocks



Page 510

Triple-deck terminal blocks

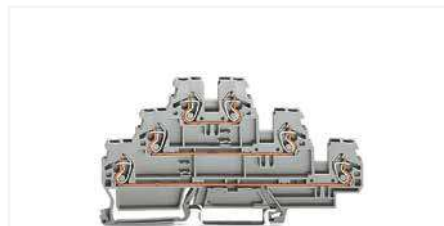

Page 512

WAGO Rail-Mount Terminal Blocks, Compact; with CAGE CLAMP COMPACT Connection

Multilevel diode and LED terminal blocks



Page 514

Pluggable tap-off modules



Page 519

Sensor and actuator terminal blocks



Page 521

Product Overview

WAGO Modular Terminal Blocks and WAGO Terminal Strips

Modular terminal blocks

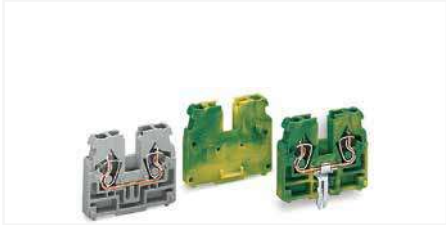

Page 528

Terminal strips; with mounting flanges



Page 527

Terminal strips; with snap-in mounting feet



Page 527

WAGO Modular Terminal Blocks and WAGO Terminal Strips

Modular terminal blocks



Page 532

Terminal strips; with mounting flanges



Page 534

Terminal strips; with snap-in mounting feet



Page 534

WAGO Modular Terminal Blocks and WAGO Terminal Strips

Modular terminal blocks



Page 538

Terminal strips; with mounting flanges



Page 539

Terminal strips; with snap-in mounting feet



Page 539

WAGO Chassis-Mount Terminal Strips WAGO Field-Wiring Terminal Blocks

4-conductor chassis-mount terminal strips



Page 558

Field-wiring terminal blocks



Page 567

Product Overview

WAGO Rail-Mount Terminal Blocks, Classic; with CAGE CLAMP® Connection

Through terminal blocks



Page 570

Ground conductor terminal blocks



Page 570

Disconnect and test terminal blocks

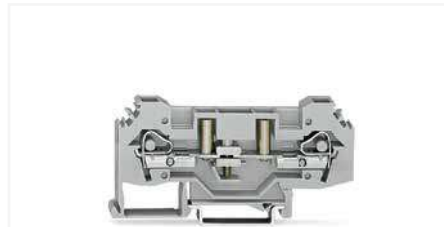

Page 584

WAGO Rail-Mount Terminal Blocks, Classic; with CAGE CLAMP® Connection

Ground conductor disconnect terminal blocks

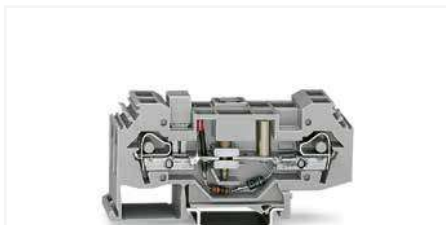

Page 585

Fused disconnect terminal blocks; for glass cartridge fuses



Page 586

WAGO Patchboard Systems

Matrix patchboards



Page 592

Matrix patchboards; with push-buttons



Page 597

Additional modules



Page 600

WAGO Patchboard Systems

Terminal blocks for matrix patching



Page 604

Common potential terminal blocks



Page 605

3-conductor, double-potential terminal blocks or terminal blocks for matrix patching



Page 609

Product Overview

WAGO Busbar Terminal Blocks

Busbar terminal blocks



Page 611

Ground busbar terminal blocks



Page 611

Insulated busbar carriers



Page 611

WAGO PUSH WIRE® Connectors for Junction Boxes

COMPACT PUSH WIRE® connector for junction boxes



Page 615

COMPACT PUSH WIRE® connector for junction boxes



Page 615

Mounting carriers



Page 615

WAGO PUSH WIRE® Connectors for Junction Boxes

PUSH WIRE® connectors for junction boxes



Page 618

Ex PUSH WIRE® connectors for junction boxes



Page 620

Mounting carriers



Page 617

WAGO PUSH WIRE® Connectors for Junction Boxes

MICRO PUSH WIRE® connectors for junction boxes



Page 624

MICRO PUSH WIRE® connectors for junction boxes



Page 624

Mounting carriers



Page 625

Product Overview

WAGO Splicing Connectors for All Conductor Types

COMPACT splicing connectors for all conductor types;
4 mm²/12 AWG



Page 627

Mounting carriers



Page 629

Mounting carrier; for 4 mm²/12 AWG single connectors



Page 631

WAGO Splicing Connectors for All Conductor Types

COMPACT splicing connectors for all conductor types;
4 mm²/12 AWG; for Ex eb applications



Page 636

Mounting carriers; for Ex eb applications



Page 636

Gelboxes; for splicing connectors



Page 641

WAGO Splicing Connectors for All Conductor Types

COMPACT splicing connectors for all conductor types;
6 mm²/10 AWG



Page 633

Mounting carriers



Page 633

COMPACT splicing connectors for all conductor types;
6 mm²/10 AWG; for Ex eb applications



Page 637

WAGO Splicing Connectors

Junction boxes; for 221 Series Splicing Connectors
(4 mm²)



Page 645

WAGO Splicing Connectors

Inline Splicing Connectors



Page 647

Mounting carriers



Page 649

Product Overview

WAGO Splicing Connectors for All Conductor Types

CLASSIC splicing connectors for all conductor types



Page 653

Mounting carriers



Page 655

WAGO Lighting Connectors

Luminaire disconnect connectors



Page 652

WAGO Lighting Connectors

Lighting connectors



Page 657

Lighting connectors



Page 657

"Service" connectors



Page 657

WAGO Splicing Connector Set

Vario-T-BOXX



Page 658

L-BOXX® 102



Page 658

Splicing connector sets



Page 660

Product Overview

WAGO Shield Connection System

Shield clamping saddles



Page 628

Shield clamping saddles



Page 671

Busbar carriers



Page 673

WAGO Marking Systems

Marker cards



Page 684

WMB Inline markers



Page 684

Marking strips



Page 684

WAGO Marking Systems

Marker carriers



Page 695

Marker carriers



Page 693

Marking cards; self-adhesive marking strips



Page 686

WAGO Mounting Accessories

Screwless end stops; DIN-35 rail



Page 702

DIN-35 rails



Page 700

Collective jumper carriers



Page 701

Product Overview

WAGO Mounting Accessories

Covers



Page 705

Screwless end stops; DIN-15 rail



Page 707

DIN-15 rails



Page 707

WAGO Tools

Operating tools



Page 708

Operating tools



Page 708

Operating tools



Page 709

WAGO Tools

Cable cutter



Page 720

Cable stripper



Page 710

Wire strippers



Page 713

WAGO Tools

Crimping tools



Page 714

Ferrules



Page 715

Measurement devices



Page 721

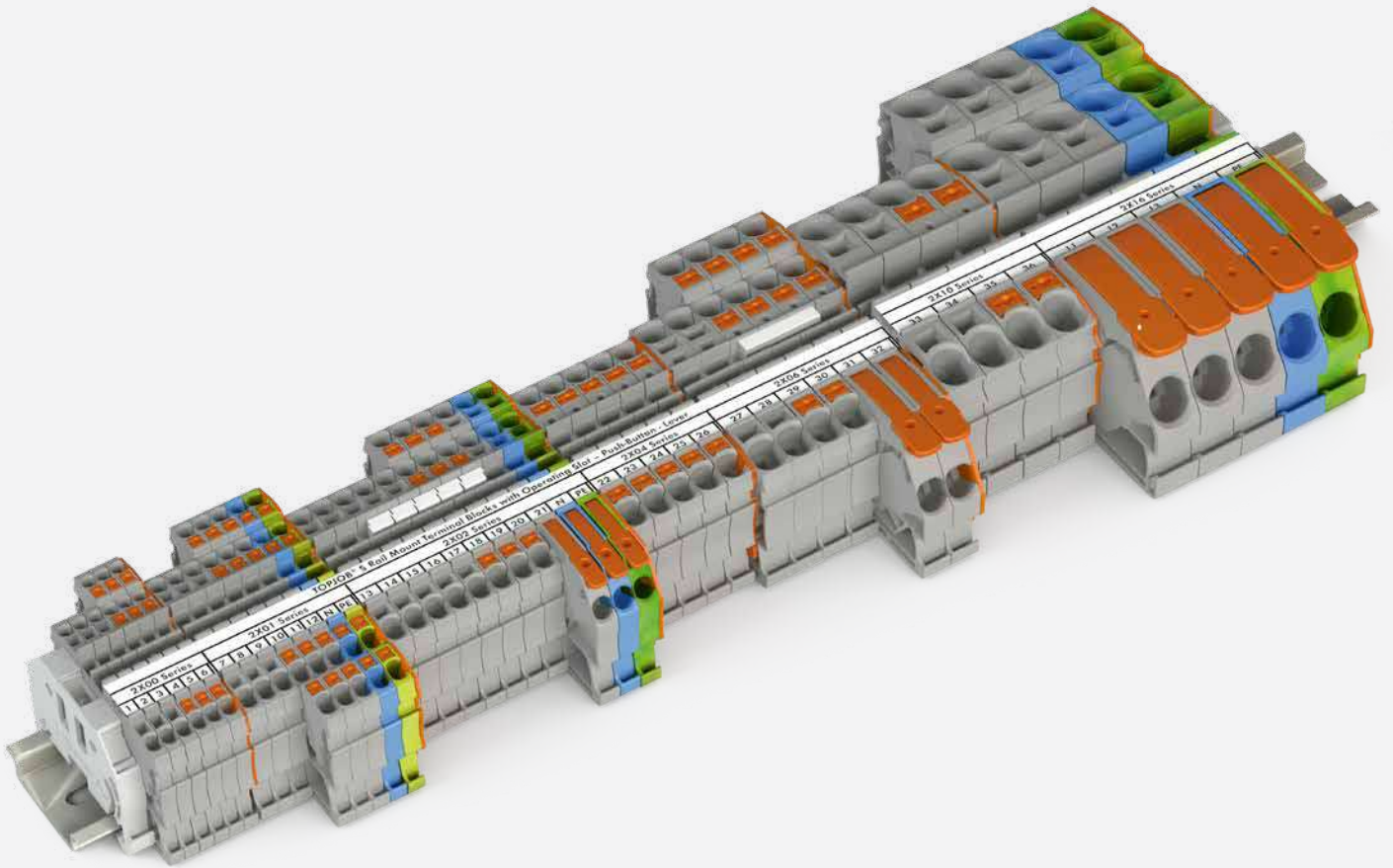

WAGO Rail-Mount Terminal Blocks TOPJOB® S

WAGO Rail-Mount Terminal Blocks TOPJOB® S

			Page
	Through Terminal Blocks and Ground Conductor Terminal Blocks; with Levers and Push-in CAGE CLAMP®	2102 ... 2116 Series	26
	Through Terminal Blocks and Ground Conductor Terminal Blocks; with Levers and Push-Buttons	2102 ... 2116 Series	31
	0.25 ... 16 (25 "f-st") mm ² (22 ... 4 AWG)		
	Through Terminal Blocks and Ground Conductor Terminal Blocks; with Push-Buttons	2200 ... 2216 Series	36
	0.14 ... 16 (25 "f-st") mm ² (24 ... 4 AWG)		66
	Distribution Terminal Blocks TOPJOB® S; with/without Push-Button	2206/2006 Series	
	1 x 6 (10) mm ² / 8 AWG and 6 x 1.5 (2.5) mm ² / 14 AWG		
	Through Terminal Blocks, Ground Conductor Terminal Blocks and Shield Conductor Terminal Blocks	2000 ... 2016 Series	52
	0.14 ... 16 (25 "f-st") mm ² (24 ... 4 AWG)		70
	Multilevel Rail-Mount Terminal Blocks; with/without Push-Buttons	2202/2000/2002 Series	
	1 (1.5) mm ² (16 AWG) and 2.5 (4) mm ² (12 AWG)		
	Disconnect/Test Terminal Blocks, Fuse Terminal Blocks and Through Terminal Blocks; with/without Push-Buttons	2202/2002 Series	94
	0.25 ... 2.5 (4) mm ² (22 ... 12 AWG)		
	Fused Disconnect Terminal Blocks with a Pivoting Fuse Holder; with/without Push-Buttons	2202/2002 Series	104
	0.25 ... 2.5 (4) mm ² (22 ... 12 AWG)		
	Disconnect Terminal Blocks, Ground Conductor Disconnect Terminal Blocks and Fuse Terminal Blocks; with/without Push-Buttons	2206/2006 Series	122
	0.5 ... 6 (10) mm ² (20 ... 8 AWG)		
	Disconnect/Test Terminal Blocks; for Current and Voltage Transformer Circuits	2007 Series	136
	0.5 ... 6 (10) mm ² (20 ... 8 AWG)		
	Fuse Plugs on Carrier Terminal Blocks	2004/2006 Series	140
	Sensor Terminal Blocks and Actuator Terminal Blocks	2000/2020 Series	146
	0.14 ... 1 (1.5) mm ² (24 ... 16 AWG)		
	Diode Terminal Blocks and LED Terminal Blocks	2001/2002/2004 Series	146
	0.25 ... 4 (6) mm ² (22 ... 10 AWG)		
	Multilevel Diode Terminal Blocks and LED Terminal Blocks	2002 Series	172
	0.25 ... 2.5 (4) mm ² (22 ... 12 AWG)		
	Diode Modules, LED Modules and Empty Component Plugs Housing	2002 Series	160
	Accessories for Rail-Mount Terminal Blocks TOPJOB® S		176

Rail-Mount Terminal Blocks TOPJOB® S; with Levers and Push-in CAGE CLAMP® 2102 to 2116 Series

Description and Installation

1

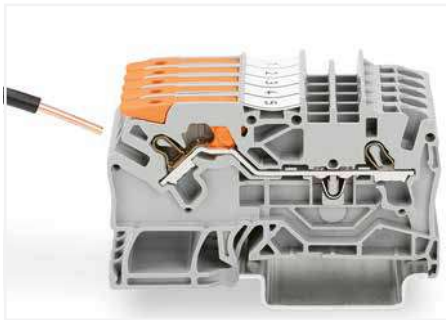

Push-in termination of solid conductors



Push-in termination of fine-stranded conductors with ferrules

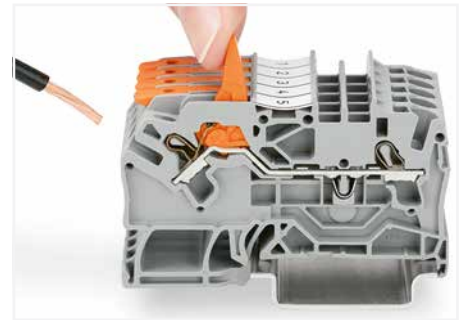

Pull the lever up until it stops, then connect the fine-stranded conductor.

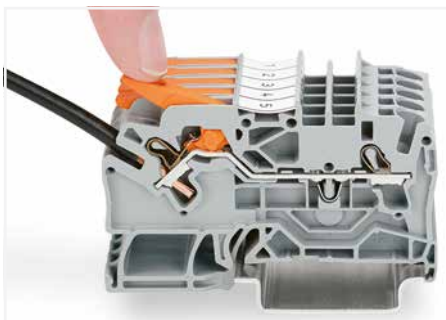

Push the lever back down – done!



Insert push-in type jumper bar and push down until it hits backstop.

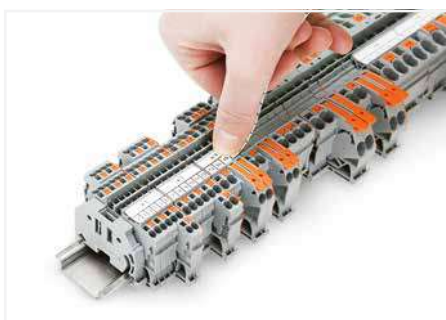
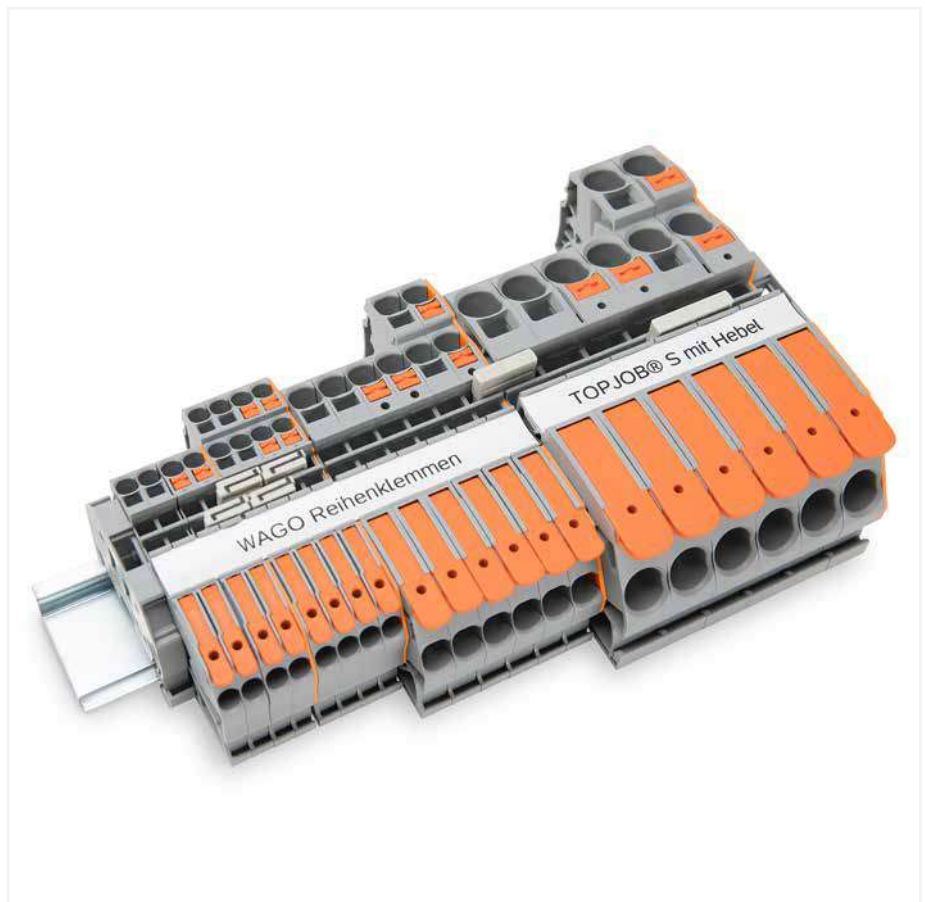

Snapping a marking strip into the marker slot.



Snapping a marking strip into the marker slot.

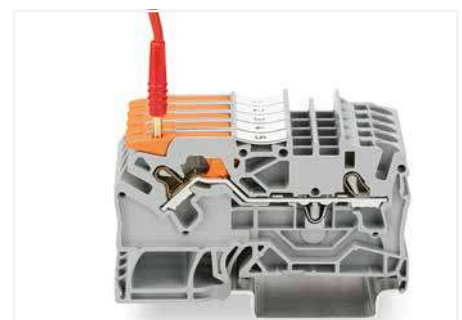

Testing with a 2 mm Ø test plug (max. 42 V).



Push-in CAGE CLAMP® terminates the following copper conductors: solid "s"



stranded "st"



fine-stranded "f-st", also with tinned single strands

PUSH-IN CAGE CLAMP®

Rail-Mount Terminal Blocks TOPJOB® S; with Push-Buttons and Push-in CAGE CLAMP®

2200 to 2216 Series

Description and Installation

1



Push-in termination of solid and ferruled conductors



Insert fine-stranded conductors via operating tool.



Removing all conductors via operating tool.

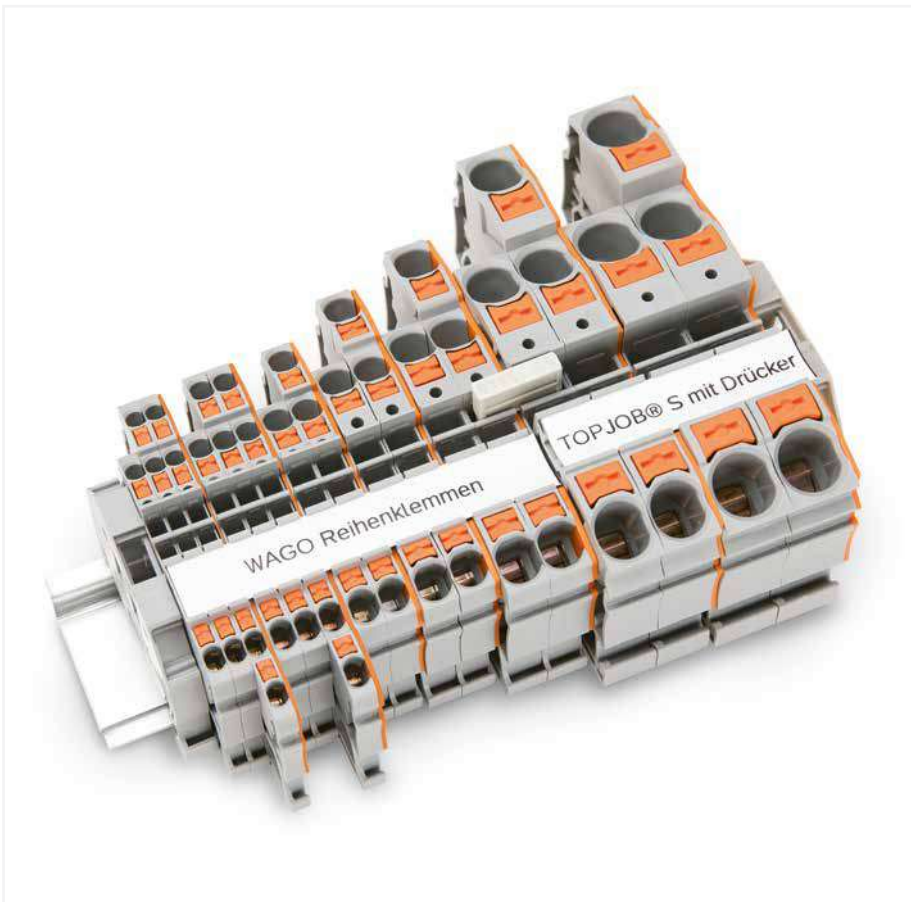

Insert push-in type jumper bar and push down until it hits backstop.



Commoning with step-down jumpers.

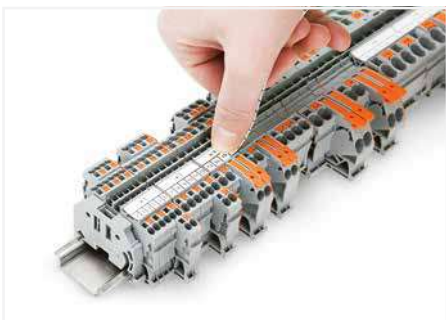

Snapping a marking strip into the marker slot.



Snapping a marking strip into the marker slot.



Testing with a 2 mm Ø test plug (max. 42 V).



fine-stranded, tip-bonded



fine-stranded, with ferrule (gastight crimped)





fine-stranded, with pin terminal (gastight crimped)

PUSH-IN CAGE CLAMP®

Through Terminal Block, Ground Conductor Terminal Block TOPJOB® S; with Lever and Push-in CAGE CLAMP® 2.5 (4) mm²; 2102 Series

1

Technical Data	
0.25 ... 2.5 (4) mm ² ①	22 ... 12 AWG
800 V / 8 kV / 3 ②	600 V, 20 A ③
I _N 24 A (32 A)	600 V, 20 A ④
Terminal block width: 5.2 mm / 0.205 inch	
 10 ... 12 mm / 0.39 ... 0.47 inch	

Technical Data	
0.25 ... 2.5 (4) mm ² ①	22 ... 12 AWG
800 V / 8 kV / 3 ②	600 V, 20 A ③
I _N 24 A (30 A)	600 V, 20 A ④
Terminal block width: 5.2 mm / 0.205 inch	
 10 ... 12 mm / 0.39 ... 0.47 inch	

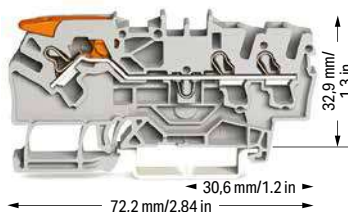
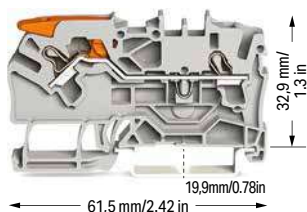





2-conductor through terminal block; with lever and Push-in CAGE CLAMP®		
Color	Item No.	Pack. Unit
gray ⑤	2102-1201 ④	50
blue ⑤	2102-1204 ③ ④	50

3-conductor through terminal block; with lever and Push-in CAGE CLAMP®		
Color	Item No.	Pack. Unit
gray ⑤	2102-1301 ④	50
blue ⑤	2102-1304 ③ ④	50

2-conductor ground terminal block; with lever and Push-in CAGE CLAMP®		
green-yellow ⑤	2102-1207 ④	50









3-conductor ground terminal block; with lever and Push-in CAGE CLAMP®		
green-yellow ⑤	2102-1307 ④	50

Accessories; item-specific			
End and intermediate plate; 0.8 mm thick			
	orange	2102-1292	100 (25)
	gray	2102-1291	100 (25)

Accessories; item-specific			
End and intermediate plate; 0.8 mm thick			
	orange	2102-1392	100 (25)
	gray	2102-1391	100 (25)

Accessories; 2102 Series
Appropriate marking systems: WMB/WMB Inline/Marking strips









Insulation stop; 5 pcs/strip; 0.25 ... 0.5 mm ²			
	light gray	2002-171	200 (25)



Push-in type jumper bar; insulated; I _N 25 A; light gray			
	1 to 3	2002-433	25
	1 to 4	2002-434	25
	1 to 5	2002-435	25
	1 to 6	2002-436	25
	1 to 7	2002-437	25
	1 to 8	2002-438	25
	1 to 9	2002-439	25
	1 to 10	2002-440	25

Insulation stop; 5 pcs/strip; 0.75 ... 1 mm ²			
	dark gray	2002-172	200 (25)



Protective warning marker; with black high-voltage symbol; for 5 terminal blocks			
	yellow	2002-115	100 (25)

Continuous jumper; insulated; I _N 25 A, light gray			
	2-way	2002-400	25



Push-in type jumper bar; insulated; I _N 25 A; light gray			
	2-way	2002-402	25
	3-way	2002-403	25
	4-way	2002-404	25
	5-way	2002-405	25
	6-way	2002-406	25
	7-way	2002-407	25
	8-way	2002-408	25
	9-way	2002-409	25
	10-way	2002-410	25

Continuous jumper; insulated; I _N 25 A; light gray			
	1 to 3	2002-423	25
	1 to 4	2002-424	25

Delta jumper; insulated; I _N = I _N terminal block; light gray			
	1-2 3-4 5-6	2002-406/020-000	25

Continuous jumper; insulated; I _N 25 A, light gray			
	3-way	2002-413	25
	5-way	2002-415	25

Star point jumper; insulated; I _N = I _N terminal block; light gray			
	1-3-5	2002-405/011-000	25

Push-in type wire jumper; insulated; 1.5 mm ² conductor cross-section; I _N 18 A			
	L = 60 mm	2009-412	100 (10)
	L = 110 mm	2009-414	100 (10)
	L = 250 mm	2009-416	100 (10)











- ① Conductor range: 0.25 ... 4 mm² "s+f-st"; Push-in termination: 1 ... 4 mm² "s" and 1 ... 2.5 mm² "insulated ferrules, 12 mm" Depending on the conductor characteristic, a conductor with a smaller cross section can also be inserted via push-in termination.
- ② 800 V = rated voltage
8 kV = rated impulse voltage
3 = pollution degree (see Section 15)
- ③ Terminal blocks with a blue insulated housing are suitable for Ex i applications.
- ④ Terminal blocks with an Ex mark are suitable for Ex e II applications.
550 V; 23.5 A
20 A jumper (see Section 15)





Please observe the application notes:
Jumpers, from page 182
Testing accessories, from page 177
Marking, from page 684

Approvals and corresponding ratings, visit www.wago.com

Accessories; 2102 Series

Appropriate marking systems:
WMB/WMB Inline/Marking strips

Staggered jumper; insulated; I _N 25 A; light gray			
	2-way	2002-472	25
	3-way	2002-473	25
	4-way	2002-474	25
	5-way	2002-475	25
	6-way	2002-476	25
	7-way	2002-477	25
	8-way	2002-478	25
	9-way	2002-479	25
	10-way	2002-480	25
	11-way	2002-481	25
	12-way	2002-482	25

Customized staggered jumper; insulated; with contact lugs broken off at the factory and circuit printing; I _N 25 A; light gray			
	1-3	2002-473/011-000	25
	1-3-5	2002-475/011-000	25
	1-3-5-7	2002-477/011-000	25
	1-3-5-7-9	2002-479/011-000	25
	1-3-5-7-9-11	2002-481/011-000	25

Modular connector; snaps together; for jumper contact slot			
	gray	2002-511	100 (25)

L-type test plug module; snaps together			
	gray	2002-611	100 (25)

Marking strip; plain; 11 mm wide; 50 m reel			
	white	2009-110	1

WMB Inline, plain; 1,500 WMB markers (5 mm)/reel; 5 ... 5.2 mm stretchable			
	white	2009-115	1

WMB marking card; white; 10 strips with 10 markers/card; 5 ... 5.2 mm stretchable			
	plain	793-5501	5

Through and Ground Conductor Terminal Block TOPJOB® S; with Lever and Push-in CAGE CLAMP®

4 (6) mm²; 2104 Series

Technical Data

0.5 ... 4 (6) mm ² ①	20 ... 10 AWG
800 V / 8 kV / 3 ②	600 V, 30 A I_N
I_N 32 A (40 A)	600 V, 30 A I_{Nc}
Terminal block width: 6.2 mm / 0.244 inch	
 11 ... 13 mm / 0.43 ... 0.51 inch	

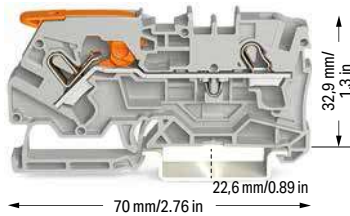

2-conductor through terminal block; with lever and Push-in CAGE CLAMP®

Color	Item No.	Pack. Unit
gray \oplus	2104-1201 ④	50
blue \oplus	2104-1204 ③ ④	50

2-conductor ground terminal block; with lever and Push-in CAGE CLAMP®

Color	Item No.	Pack. Unit
green-yellow \oplus	2104-1207 ④	50

Item-Specific Accessories

End and intermediate plate; 0.8 mm thick

Color	Item No.	Pack. Unit
orange	2104-1292	100 (25)
gray	2104-1291	100 (25)

Accessories; 2104 Series

Appropriate marking systems: WMB/WMB Inline/Marking strips

Insulation stop; 5 pcs/strip; 0.25 ... 0.5 mm²

Color	Item No.	Pack. Unit
light gray	2004-171	200 (25)

Insulation stop; 5 pcs/strip; 0.75 ... 1 mm²

Color	Item No.	Pack. Unit
dark gray	2004-172	200 (25)

Protective warning marker; with black high-voltage symbol; for 5 terminal blocks

Color	Item No.	Pack. Unit
yellow	2004-115	100 (25)

Push-in type jumper bar; insulated; I_N 32 A; light gray

Way	Item No.	Pack. Unit
2-way	2004-402	25
3-way	2004-403	25
4-way	2004-404	25
5-way	2004-405	25
6-way	2004-406	25
7-way	2004-407	25
8-way	2004-408	25
9-way	2004-409	25
10-way	2004-410	25

Push-in type jumper bar; insulated; I_N 32 A; light gray

Way	Item No.	Pack. Unit
1 to 3	2004-433	25
1 to 4	2004-434	25
1 to 5	2004-435	25
1 to 6	2004-436	25
1 to 7	2004-437	25
1 to 8	2004-438	25
1 to 9	2004-439	25
1 to 10	2004-440	25

Technical Data

0.5 ... 4 (6) mm ² ①	20 ... 10 AWG
800 V / 8 kV / 3 ②	600 V, 30 A I_N
I_N 32 A (40 A)	600 V, 30 A I_{Nc}
Terminal block width: 6.2 mm / 0.244 inch	
 11 ... 13 mm / 0.43 ... 0.51 inch	

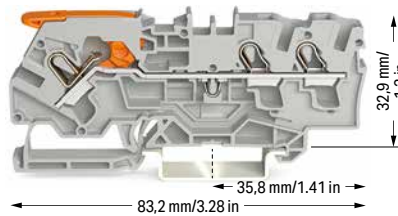

3-conductor through terminal block; with lever and Push-in CAGE CLAMP®

Color	Item No.	Pack. Unit
gray \oplus	2104-1301 ④	50
blue \oplus	2104-1304 ③ ④	50

3-conductor ground terminal block; with lever and Push-in CAGE CLAMP®

Color	Item No.	Pack. Unit
green-yellow \oplus	2104-1307 ④	50

Item-Specific Accessories

End and intermediate plate; 0.8 mm thick

Color	Item No.	Pack. Unit
orange	2104-1392	100 (25)
gray	2104-1391	100 (25)

① Conductor range: 0.5 ... 6 mm² "s+f-st"
Push-in termination: 1.5 ... 6 mm² "s" and 1.5 ... 4 mm² "insulated ferrules, 12 mm"
Depending on the conductor characteristic, a conductor with a smaller cross-section can also be inserted via push-in termination.

② 800 V = rated voltage
8 kV = rated impulse voltage
3 = pollution degree (see Section 15)

③ Terminal blocks with a blue housing are suitable for Ex i applications.

④ Terminal blocks with an Ex mark are suitable for Ex e II applications.
550 V; 30 A (see Section 15)

Please observe the application notes:
Jumpers, from page 185
Testing accessories, from page 178
Marking, from page 684

Approvals and corresponding ratings, visit www.wago.com

Accessories; 2104 Series

Appropriate marking systems:
WMB/WMB Inline/Marking strips

Marking strip; plain; 11 mm wide; 50 m reel

Color	Item No.	Pack. Unit
white	2009-110	1

WMB marker card; white; 10 strips with 10 markers/card; stretchable 5 ... 5.2 mm

Color	Item No.	Pack. Unit
plain	793-5501	5

PUSH-IN CAGE CLAMP®

Through Terminal Block, Ground Conductor Terminal Block TOPJOB® S; with Lever and Push-in CAGE CLAMP® 6 (10) mm²; 2106 Series

1

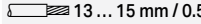
Technical Data	
0.5 ... 6 (10) mm ² ①	20 ... 8 AWG
800 V / 8 kV / 3 ②	600 V, 50 A ③
I _N 41 A (55 A)	600 V, 50 A ④
Terminal block width: 7.5 mm / 0.295 inch	
 13 ... 15 mm / 0.51 ... 0.59 inch	

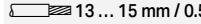
Technical Data	
0.5 ... 6 (10) mm ² ①	20 ... 8 AWG
800 V / 8 kV / 3 ②	600 V, 50 A ③
I _N 41 A (55 A)	600 V, 50 A ④
Terminal block width: 7.5 mm / 0.295 inch	
 13 ... 15 mm / 0.51 ... 0.59 inch	

- ① Conductor range: 0.5 ... 10 mm² "s+f-st"; Push-in termination: 2.5 ... 10 mm² "s" and 2.5 ... 6 mm² "insulated ferrules; 12 mm"
Depending on the conductor characteristic, a conductor with a smaller cross section can also be inserted via push-in termination.
- ② 800 V = rated voltage
8 kV = rated impulse voltage
3 = pollution degree (see Section 15)
- ③ Terminal blocks with a blue insulated housing are suitable for Ex i applications.
- ④ Terminal blocks with an Ex mark are suitable for Ex e II applications.
550 V; 41 A
33 A jumper (see Section 15)

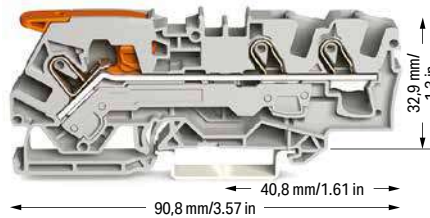

2-conductor through terminal block; with lever and Push-in CAGE CLAMP®

Color	Item No.	Pack. Unit
gray ⑤	2106-1201 ④	25
blue ⑤	2106-1204 ③ ④	25

3-conductor through terminal block; with lever and Push-in CAGE CLAMP®

Color	Item No.	Pack. Unit
gray ⑤	2106-1301 ④	25
blue ⑤	2106-1304 ③ ④	25



2-conductor ground terminal block; with lever and Push-in CAGE CLAMP®

green-yellow ⑤	2106-1207 ④	25
----------------	-------------	----



3-conductor ground terminal block; with lever and Push-in CAGE CLAMP®

green-yellow ⑤	2106-1307 ④	25
----------------	-------------	----

Accessories; item-specific

End and intermediate plate; 1 mm thick			
	orange	2106-1292	100 (25)
	gray	2106-1291	100 (25)

Accessories; item-specific

End and intermediate plate; 1 mm thick			
	orange	2106-1392	100 (25)
	gray	2106-1391	100 (25)

Accessories; 2106 Series

Appropriate marking systems: WMB/WMB Inline/Marking strips

Push-in type jumper bar; insulated; I_N 41 A; light gray

	2-way	2006-402	25
	3-way	2006-403	25
	4-way	2006-404	25
	5-way	2006-405	25

Test plug adapter; for 4 mm Ø test plug

	gray	2009-174	100 (25)
---	------	----------	----------

Push-in type jumper bar; insulated; I_N 41 A; light gray

	1 to 3	2006-433	25
	1 to 4	2006-434	25
	1 to 5	2006-435	25

Testing tap; for max. 2.5 mm²

	gray	2009-182	100 (25)
---	------	----------	----------

Star point jumper; insulated; I_N = I_N terminal block; light gray

	1-3-5	2006-405/011-000	25
---	-------	------------------	----

Marking strip; plain; 11 mm wide; 50 m reel

	white	2009-110	1
---	-------	----------	---

Protective warning marker; with black high-voltage symbol; for 5 terminal blocks

	yellow	2006-115	100 (25)
---	--------	----------	----------

WMB marking card; white; 10 strips with 10 markers/card; 5 ... 5.2 mm stretchable

	plain	793-5501	5
---	-------	----------	---

Lockout cap; for conductor entry and operating slot

	gray	2006-191	25
---	------	----------	----

Modular connector; snaps together; for jumper contact slot

	gray	2006-511	50 (25)
---	------	----------	---------

Spacer module; snaps together; bridges commoned terminal blocks

	gray	2006-549	50 (25)
---	------	----------	---------

Please observe the application notes:
Jumpers, from page 185
Testing accessories, from page 178
Marking, from page 684

Approvals and corresponding ratings,
visit www.wago.com

Through Terminal Block, Ground Conductor Terminal Block TOPJOB® S; with Lever and Push-in CAGE CLAMP®

10 (16) mm²; 2110 Series

Technical Data

0.5 ... 10 (16) mm ² ①	20 ... 6 AWG
800 V / 8 kV / 3 ②	600 V, 65 A ③
I _N 57 A	
Terminal block width: 10 mm / 0.394 inch	
17 ... 19 mm / 0.67 ... 0.75 inch	

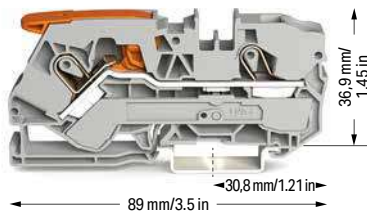

2-conductor through terminal block; with lever and Push-in CAGE CLAMP®

Color	Item No.	Pack. Unit
gray ④	2110-1201 ④	25
blue ④	2110-1204 ③ ④	25

2-conductor ground terminal block; with lever and Push-in CAGE CLAMP®

green-yellow ④	2110-1207 ④	25
----------------	-------------	----

Item-Specific Accessories

End and intermediate plate; 1 mm thick

orange	2110-1292	100 (25)
gray	2110-1291	100 (25)

Accessories; 2110 Series

Appropriate marking systems: WMB/WMB Inline/Marking strips

Push-in type jumper bar; insulated; I_N 57 A; light gray

2-way	2010-402	25
3-way	2010-403	25
4-way	2010-404	25
5-way	2010-405	25

Push-in type jumper bar; insulated; I_N 57 A; light gray

1 to 3	2010-433	25
1 to 4	2010-434	25
1 to 5	2010-435	25

Star point jumper; insulated; I_N = I_N terminal block; light gray

1-3-5	2010-405/011-000	25
-------	------------------	----

Protective warning marker; with black high-voltage symbol; for 5 terminal blocks

yellow	2010-115	100 (25)
--------	----------	----------

Finger guard; touch-proof cover protects unused conductor entries

yellow	2010-100	100 (25)
--------	----------	----------

Modular connector; snaps together; for jumper contact slot

gray	2010-511	50 (25)
------	----------	---------

Spacer module; snaps together; bridges commoned terminal blocks

gray	2010-549	50 (25)
------	----------	---------

Technical Data

0.5 ... 10 (16) mm ² ①	20 ... 6 AWG
800 V / 8 kV / 3 ②	600 V, 65 A ③
I _N 57 A	
Terminal block width: 10 mm / 0.394 inch	
17 ... 19 mm / 0.67 ... 0.75 inch	

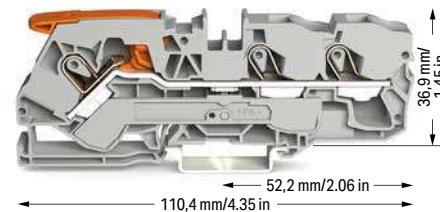

3-conductor through terminal block; with lever and Push-in CAGE CLAMP®

Color	Item No.	Pack. Unit
gray ④	2110-1301 ④	25
blue ④	2110-1304 ③ ④	25

3-conductor ground terminal block; with lever and Push-in CAGE CLAMP®

green-yellow ④	2110-1307 ④	25
----------------	-------------	----

Item-Specific Accessories

End and intermediate plate; 1 mm thick

orange	2110-1392	100 (25)
gray	2110-1391	100 (25)

① Conductor range: 0.5 ... 16 mm² "s+f-st"
Push-in termination: 4 ... 16 mm² "s" and 4 ... 10 mm² "insulated ferrules, 18 mm"
Depending on the conductor characteristic, a conductor with a smaller cross section can also be inserted via push-in termination.

② 800 V = rated voltage
8 kV = rated impulse voltage
3 = pollution degree (see Section 15)

③ Terminal blocks with a blue insulated housing are suitable for Ex i applications.

④ Terminal blocks with an Ex mark are suitable for Ex e II applications.
550 V; 57 A
50 A jumper (see Section 15)

Please observe the application notes:
Jumpers, from page 185
Testing accessories, from page 178
Marking, from page 684

Approvals and corresponding ratings, visit www.wago.com

PUSH-IN CAGE CLAMP®

Through Terminal Block, Ground Conductor Terminal Block TOPJOB® S; with Lever and Push-in CAGE CLAMP®

16 (25 "f-st") mm²; 2116 Series

1

Technical Data

0.5 ... 16 (25 "f-st") mm ² ①	20 ... 4 AWG
800 V / 8 kV / 3 ②	600 V, 85 A ③
I _N 76 A (90 A)	600 V, 78 A ④
Terminal block width: 12 mm / 0.472 inch	
 18 ... 20 mm / 0.71 ... 0.79 inch	

Technical Data

0.5 ... 16 (25 "f-st") mm ² ①	20 ... 4 AWG
800 V / 8 kV / 3 ②	600 V, 85 A ③
I _N 76 A (90 A)	600 V, 78 A ④
Terminal block width: 12 mm / 0.472 inch	
 18 ... 20 mm / 0.71 ... 0.79 inch	

① Conductor range: 0.5 ... 16 mm² "s+f-st", 25 mm² "f-st"; Push-in termination: 6 ... 16 mm² "s" and 6 ... 16 mm² "insulated ferrules; 18 mm"
Depending on the conductor characteristic, a conductor with a smaller cross section can also be inserted via push-in termination.

② 800 V = rated voltage
8 kV = rated impulse voltage
3 = pollution degree (see Section 15)

③ Terminal blocks with a blue insulated housing are suitable for Ex i applications.

④ Terminal blocks with an Ex mark are suitable for Ex e II applications.
550 V; 76 A
65 A jumper (see Section 15)

Please observe the application notes:
Jumpers, from page 185
Testing accessories, from page 179
Marking, from page 684

Approvals and corresponding ratings, visit www.wago.com



2-conductor through terminal block; with lever and Push-in CAGE CLAMP®

Color	Item No.	Pack. Unit
gray ⑤	2116-1201	20
blue ⑤	2116-1204 ⑥	20

3-conductor through terminal block; with lever and Push-in CAGE CLAMP®

Color	Item No.	Pack. Unit
gray ⑤	2116-1301	20
blue ⑤	2116-1304 ⑥	20

2-conductor ground terminal block; with lever and Push-in CAGE CLAMP®
15 mm high DIN-35 rails shall be used for a current load higher than 76 A!

green-yellow ⑤	2116-1207	20
----------------	-----------	----

3-conductor ground terminal block; with lever and Push-in CAGE CLAMP®
15 mm high DIN-35 rails shall be used for a current load higher than 76 A!

green-yellow ⑤	2116-1307	20
----------------	-----------	----

Accessories; item-specific

End and intermediate plate; 1 mm thick

orange	2116-1292	100 (25)
gray	2116-1291	100 (25)

Accessories; item-specific

End and intermediate plate; 1 mm thick

orange	2116-1392	100 (25)
gray	2116-1391	100 (25)

Accessories; 2116 Series

Appropriate marking systems: WMB/WMB Inline/Marking strips

Push-in type jumper bar; insulated; I_N 76 A; light gray

	2-way	2016-402	25
	3-way	2016-403	25
	4-way	2016-404	25
	5-way	2016-405	25

Modular connector; snaps together; for jumper contact slot

	gray	2016-511	50 (25)
---	------	----------	---------

Push-in type jumper bar; insulated; I_N 76 A; light gray

	1 to 3	2016-433	25
	1 to 4	2016-434	25
	1 to 5	2016-435	25

Spacer module; snaps together; bridges commoned terminal blocks

	gray	2016-549	50 (25)
---	------	----------	---------

Star point jumper; insulated; I_N = I_N terminal block; light gray

	1-3-5	2016-405/011-000	25
--	-------	------------------	----

Test plug adapter; for 4 mm Ø test plug

	gray	2009-174	100 (25)
---	------	----------	----------

Protective warning marker; with black high-voltage symbol; for 5 terminal blocks

	yellow	2016-115	100 (25)
--	--------	----------	----------

Testing tap; for max. 2.5 mm²

	gray	2009-182	100 (25)
---	------	----------	----------

Three-phase set; with orange end plate; with a lever and Push-in CAGE CLAMP®
15 mm high DIN-35 rails shall be used for a current load higher than 76 A!

	2116-1201/605-038	1
--	-------------------	---

Marking strip; plain; 11 mm wide; 50 m reel

	white	2009-110	1
---	-------	----------	---

Finger guard; touch-proof cover protects unused conductor entries

	yellow	2016-100	100 (25)
---	--------	----------	----------

WMB marking card; white; 10 strips with 10 markers/card; 5 ... 5.2 mm stretchable

	plain	793-5501	5
---	-------	----------	---

Through Terminal Block, Ground Conductor Terminal Block TOPJOB® S; with Lever and Push-Button

2.5 (4) mm²; 2102 Series

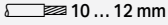
Technical Data	
0.25 ... 2.5 (4) mm ² ①	22 ... 12 AWG
800 V / 8 kV / 3 ②	600 V, 20 A ③
I _N 24 A (32 A)	600 V, 20 A ④
Terminal block width: 5.2 mm / 0.205 inch	
 10 ... 12 mm / 0.39 ... 0.47 inch	

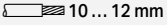
Technical Data	
0.25 ... 2.5 (4) mm ² ①	22 ... 12 AWG
800 V / 8 kV / 3 ②	600 V, 20 A ③
I _N 24 A (30 A)	600 V, 20 A ④
Terminal block width: 5.2 mm / 0.205 inch	
 10 ... 12 mm / 0.39 ... 0.47 inch	

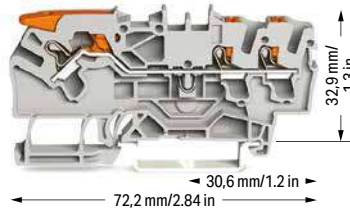
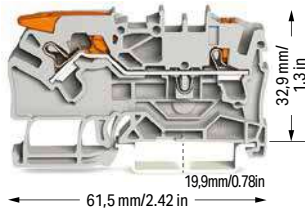





2-conductor through terminal block; with lever and push-button		
Color	Item No.	Pack. Unit
gray ⑤	2102-5201 ④	50
blue ⑤	2102-5204 ③ ④	50

3-conductor through terminal block; with lever and push-button		
Color	Item No.	Pack. Unit
gray ⑤	2102-5301 ④	50
blue ⑤	2102-5304 ③ ④	50

2-conductor ground terminal block; with lever and push-button		
green-yellow ⑤	2102-5207 ④	50

3-conductor ground terminal block; with lever and push-button		
green-yellow ⑤	2102-5307 ④	50

Accessories; item-specific			
End and intermediate plate; 0.8 mm thick			
	orange	2102-1292	100 (25)
	gray	2102-1291	100 (25)

Accessories; item-specific			
End and intermediate plate; 0.8 mm thick			
	orange	2102-1392	100 (25)
	gray	2102-1391	100 (25)









Accessories; 2102 Series
Appropriate marking systems: WMB/WMB Inline/Marking strips



Insulation stop; 5 pcs/strip; 0.25 ... 0.5 mm ²			
	light gray	2002-171	200 (25)









Star point jumper; insulated; I _N = I _N terminal block; light gray			
	1-3-5	2002-405/011-000	25



Insulation stop; 5 pcs/strip; 0.75 ... 1 mm ²			
	dark gray	2002-172	200 (25)

Continuous jumper; insulated; I _N 25 A, light gray			
	2-way	2002-400	25











Push-in type jumper bar; insulated; I _N 25 A; light gray			
	2-way	2002-402	25
	3-way	2002-403	25
	4-way	2002-404	25
	5-way	2002-405	25
	6-way	2002-406	25
	7-way	2002-407	25
	8-way	2002-408	25
	9-way	2002-409	25
	10-way	2002-410	25

Continuous jumper; insulated; I _N 25 A; light gray			
	1 to 3	2002-423	25
	1 to 4	2002-424	25

Push-in type jumper bar; insulated; I _N 25 A; light gray			
	1 to 3	2002-433	25
	1 to 4	2002-434	25
	1 to 5	2002-435	25
	1 to 6	2002-436	25
	1 to 7	2002-437	25
	1 to 8	2002-438	25
	1 to 9	2002-439	25
	1 to 10	2002-440	25

Continuous jumper; insulated; I _N 25 A, light gray			
	3-way	2002-413	25
	5-way	2002-415	25

Delta jumper; insulated; I _N = I _N terminal block; light gray			
	1-2 3-4 5-6	2002-406/020-000	25

Staggered jumper; insulated; I _N 25 A; light gray			
	2-way	2002-472	25
	3-way	2002-473	25
	4-way	2002-474	25
	5-way	2002-475	25
	6-way	2002-476	25
	7-way	2002-477	25
	8-way	2002-478	25
	9-way	2002-479	25
	10-way	2002-480	25
	11-way	2002-481	25
	12-way	2002-482	25

① Conductor range: 0.25 ... 4 mm² "s+f-st"; Push-in termination: 1 ... 4 mm² "s" and 1 ... 2.5 mm² "insulated ferrules, 12 mm"
Depending on the conductor characteristic, a conductor with a smaller cross section can also be inserted via push-in termination.

② 800 V = rated voltage
8 kV = rated impulse voltage
3 = pollution degree (see Section 15)

③ Terminal blocks with a blue insulated housing are suitable for Ex i applications.

④ Terminal blocks with an Ex mark are suitable for Ex e II applications.
550 V; 23.5 A
20 A jumper (see Section 15)

Please observe the application notes:
Jumpers, from page 182
Testing accessories, from page 177
Marking, from page 684

Approvals and corresponding ratings, visit www.wago.com

Accessories; 2102 Series
Appropriate marking systems:
WMB/WMB Inline/Marking strips

Customized staggered jumper; insulated; with contact lugs broken off at the factory and circuit printing; I_N 25 A; light gray

	1-3	2002-473/011-000	25
	1-3-5	2002-475/011-000	25
	1-3-5-7	2002-477/011-000	25
	1-3-5-7-9	2002-479/011-000	25
	1-3-5-7-9-11	2002-481/011-000	25

Push-in type wire jumper; insulated; 1.5 mm² conductor cross-section; I_N 18 A

	L = 60 mm	2009-412	100 (10)
	L = 110 mm	2009-414	100 (10)
	L = 250 mm	2009-416	100 (10)

Modular connector; snaps together; for jumper contact slot

	gray	2002-511	100 (25)
---	------	----------	----------

Spacer module; snaps together; bridges commoned terminal blocks

	gray	2002-549	100 (25)
---	------	----------	----------

Test plug adapter; for 4 mm Ø test plug

	gray	2009-174	100 (25)
---	------	----------	----------

Testing tap; for max. 2.5 mm²

	gray	2009-182	100 (25)
---	------	----------	----------

Marking strip; plain; 11 mm wide; 50 m reel

	white	2009-110	1
---	-------	----------	---

WMB Inline, plain; 1,500 WMB markers (5 mm)/reel; 5 ... 5.2 mm stretchable

	white	2009-115	1
---	-------	----------	---

	WMB marking card; white; 10 strips with 10 markers/card; 5 ... 5.2 mm stretchable	plain	793-5501	5
---	---	-------	----------	---

Through and Ground Conductor Terminal Block TOPJOB® S; with Lever and Push-Button

4 (6) mm²; 2104 Series

1

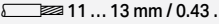
Technical Data	
0.5 ... 4 (6) mm ² ①	20 ... 10 AWG
800 V / 8 kV / 3 ②	600 V, 30 A ③
I _N 32 A (40 A)	600 V, 30 A ④
Terminal block width: 6.2 mm / 0.244 inch	
 11 ... 13 mm / 0.43 ... 0.51 inch	

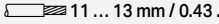
Technical Data	
0.5 ... 4 (6) mm ² ①	20 ... 10 AWG
800 V / 8 kV / 3 ②	600 V, 30 A ③
I _N 32 A (40 A)	600 V, 30 A ④
Terminal block width: 6.2 mm / 0.244 inch	
 11 ... 13 mm / 0.43 ... 0.51 inch	

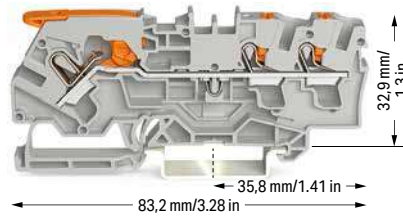
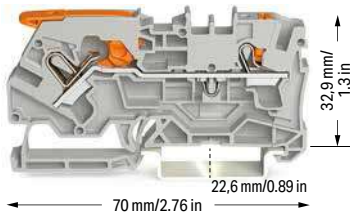





2-conductor through terminal block; with lever and push-button		
Color	Item No.	Pack. Unit
gray ⑤	2104-5201 ④	50
blue ⑤	2104-5204 ③ ④	50

3-conductor through terminal block; with lever and push-button		
Color	Item No.	Pack. Unit
gray ⑤	2104-5301 ④	50
blue ⑤	2104-5304 ③ ④	50

2-conductor ground terminal block; with lever and push-button		
Color	Item No.	Pack. Unit
green-yellow ⑤	2104-5207 ④	50

3-conductor ground terminal block; with lever and push-button		
Color	Item No.	Pack. Unit
green-yellow ⑤	2104-5307 ④	50

Item-Specific Accessories			
End and intermediate plate; 0.8 mm thick			
	orange	2104-1292	100 (25)
	gray	2104-1291	100 (25)

Item-Specific Accessories			
End and intermediate plate; 0.8 mm thick			
	orange	2104-1392	100 (25)
	gray	2104-1391	100 (25)

Accessories; 2104 Series
Appropriate marking systems: WMB/WMB Inline/Marking strips

Insulation stop; 5 pcs/strip; 0.25 ... 0.5 mm ²			
	light gray	2004-171	200 (25)

Star point jumper; insulated; I _N = I _N terminal block; light gray			
	1-3-5	2004-405/011-000	25

Insulation stop; 5 pcs/strip; 0.75 ... 1 mm ²			
	dark gray	2004-172	200 (25)

Delta jumper; insulated; I _N = I _N terminal block; light gray			
	1-2 3-4 5-6	2004-406/020-000	

Push-in type jumper bar; insulated; I _N 32 A; light gray			
	2-way	2004-402	25
	3-way	2004-403	25
	4-way	2004-404	25
	5-way	2004-405	25
	6-way	2004-406	25
	7-way	2004-407	25
	8-way	2004-408	25
	9-way	2004-409	25
	10-way	2004-410	25

Modular connector; snaps together; for jumper contact slot			
	gray	2004-511	100 (25)

Push-in type jumper bar; insulated; I _N 32 A; light gray			
	1 to 3	2004-433	25
	1 to 4	2004-434	25
	1 to 5	2004-435	25
	1 to 6	2004-436	25
	1 to 7	2004-437	25
	1 to 8	2004-438	25
	1 to 9	2004-439	25
	1 to 10	2004-440	25

Test plug adapter; for 4 mm Ø test plug			
	gray	2009-174	100 (25)

Testing tap; for max. 2.5 mm ²			
	gray	2009-182	100 (25)

- ① Conductor range: 0.5 ... 6 mm² "s+f-st"
Push-in termination: 1.5 ... 6 mm² "s" and 1.5 ... 4 mm² "insulated ferrules, 12 mm"
Depending on the conductor characteristic, a conductor with a smaller cross-section can also be inserted via push-in termination.
- ② 800 V = rated voltage
8 kV = rated impulse voltage
3 = pollution degree (see Section 15)
- ③ Terminal blocks with a blue insulated housing are suitable for Ex i applications.
- ④ Terminal blocks with an Ex mark are suitable for Ex e II applications.
550 V; 28 A (see Section 15)

Please observe the application notes:
Jumpers, from page 185
Testing accessories, from page 178
Marking, from page 684

Approvals and corresponding ratings, visit www.wago.com

Accessories; 2104 Series
Appropriate marking systems:
WMB/WMB Inline/Marking strips

Marking strip; plain; 11 mm wide; 50 m reel			
	white	2009-110	1

WMB marker card; white; 10 strips with 10 markers/card; stretchable 5 ... 5.2 mm

	plain	793-5501	5
---	-------	----------	---

Through Terminal Block, Ground Conductor Terminal Block TOPJOB® S; with Lever and Push-Button

6 (10) mm²; 2106 Series

Technical Data

0.5 ... 6 (10) mm ² ①	20 ... 8 AWG
800 V / 8 kV / 3 ②	600 V, 50 A ③
I _N 41 A (55 A)	600 V, 50 A ④
Terminal block width: 7.5 mm / 0.295 inch	
 13 ... 15 mm / 0.51 ... 0.59 inch	



2-conductor through terminal block; with lever and push-button

Color	Item No.	Pack. Unit
gray ⑤	2106-5201 ④	25
blue ⑤	2106-5204 ③ ④	25

2-conductor ground terminal block; with lever and push-button

green-yellow ⑤	2106-5207 ④	25
----------------	-------------	----

Accessories; item-specific

End and intermediate plate; 1 mm thick

orange	2106-1292	100 (25)
gray	2106-1291	100 (25)

Accessories; 2106 Series

Appropriate marking systems: WMB/WMB Inline/Marking strips

Push-in type jumper bar; insulated; I_N 41 A; light gray

	2-way	2006-402	25
	3-way	2006-403	25
	4-way	2006-404	25
	5-way	2006-405	25

Push-in type jumper bar; insulated; I_N 41 A; light gray

	1 to 3	2006-433	25
	1 to 4	2006-434	25
	1 to 5	2006-435	25

Star point jumper; insulated; I_N = I_N terminal block; light gray

	1-3-5	2006-405/011-000	25
---	-------	------------------	----

Lockout cap; for conductor entry and operating slot

	gray	2006-191	25
---	------	----------	----

Modular connector; snaps together; for jumper contact slot

	gray	2006-511	50 (25)
---	------	----------	---------

Spacer module; snaps together; bridges commoned terminal blocks

	gray	2006-549	50 (25)
---	------	----------	---------

Technical Data

0.5 ... 6 (10) mm ² ①	20 ... 8 AWG
800 V / 8 kV / 3 ②	600 V, 50 A ③
I _N 41 A (55 A)	600 V, 50 A ④
Terminal block width: 7.5 mm / 0.295 inch	
 13 ... 15 mm / 0.51 ... 0.59 inch	

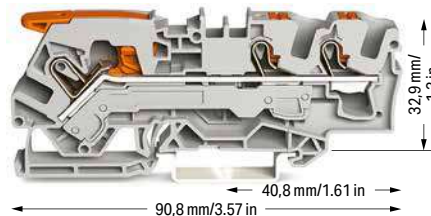

3-conductor through terminal block; with lever and push-button

Color	Item No.	Pack. Unit
gray ⑤	2106-5301 ④	25
blue ⑤	2106-5304 ③ ④	25

3-conductor ground terminal block; with lever and push-button

green-yellow ⑤	2106-5307 ④	25
----------------	-------------	----

Accessories; item-specific

End and intermediate plate; 1 mm thick

orange	2106-1392	100 (25)
gray	2106-1391	100 (25)

Test plug adapter; for 4 mm Ø test plug

	gray	2009-174	100 (25)
---	------	----------	----------

Testing tap; for max. 2.5 mm²

	gray	2009-182	100 (25)
---	------	----------	----------

Marking strip; plain; 11 mm wide; 50 m reel

	white	2009-110	1
---	-------	----------	---

WMB marking card; white; 10 strips with 10 markers/card; 5 ... 5.2 mm stretchable

	plain	793-5501	5
---	-------	----------	---

① Conductor range: 0.5 ... 10 mm² "s+f-st";
Push-in termination: 2.5 ... 10 mm² "s" and
2.5 ... 6 mm² "insulated ferrules; 12 mm"
Depending on the conductor characteristic, a conductor
with a smaller cross section can also be inserted
via push-in termination.

② 800 V = rated voltage
8 kV = rated impulse voltage
3 = pollution degree
(see Section 15)

③ Terminal blocks with a blue insulated housing are
suitable for Ex i applications.

④ Terminal blocks with an Ex mark are suitable for Ex e II
applications.
550 V; 41 A
33 A jumper
(see Section 15)

Please observe the application notes:
Jumpers, from page 185
Testing accessories, from page 178
Marking, from page 684

Approvals and corresponding ratings,
visit www.wago.com

PUSH-IN CAGE CLAMP®

Through Terminal Block, Ground Conductor Terminal Block TOPJOB® S; with Lever and Push-Button

10 (16) mm²; 2110 Series

1

Technical Data

0.5 ... 10 (16) mm² ①	20 ... 6 AWG
800 V / 8 kV / 3 ②	600 V, 65 A ③
I _N 57 A	
Terminal block width: 10 mm / 0.394 inch	
17 ... 19 mm / 0.67 ... 0.75 inch	

Technical Data

0.5 ... 10 (16) mm² ①	20 ... 6 AWG
800 V / 8 kV / 3 ②	600 V, 65 A ③
I _N 57 A	
Terminal block width: 10 mm / 0.394 inch	
17 ... 19 mm / 0.67 ... 0.75 inch	

- ① Conductor range: 0.5 ... 16 mm² "s+f-st"
Push-in termination: 4 ... 16 mm² "s" and 4 ... 10 mm² "insulated ferrules, 18 mm"
Depending on the conductor characteristic, a conductor with a smaller cross section can also be inserted via push-in termination.
- ② 800 V = rated voltage
8 kV = rated impulse voltage
3 = pollution degree (see Section 15)
- ③ Terminal blocks with a blue housing are suitable for Ex i applications.
- ④ Terminal blocks with an Ex mark are suitable for Ex e II applications.
550 V; 57 A
50 A jumper (see Section 15)

Please observe the application notes:
Jumpers, from page 185
Testing accessories, from page 178
Marking, from page 684

Approvals and corresponding ratings, visit www.wago.com

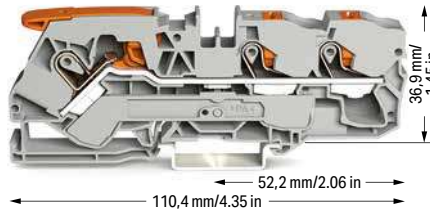
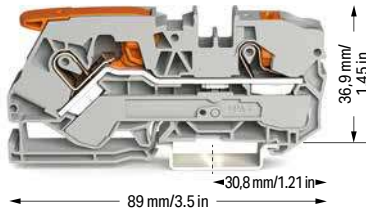

2-conductor through terminal block; with lever and push-button

Color	Item No.	Pack. Unit
gray ④	2110-5201 ④	25
blue ④	2110-5204 ③ ④	25

3-conductor through terminal block; with lever and push-button

Color	Item No.	Pack. Unit
gray ④	2110-5301 ④	25
blue ④	2110-5304 ③ ④	25

2-conductor ground terminal block; with lever and Push-in CAGE CLAMP®

green-yellow ④	2110-5207 ④	25
----------------	-------------	----

3-conductor ground terminal block; with lever and Push-in CAGE CLAMP®

green-yellow ④	2110-5307 ④	25
----------------	-------------	----

Item-Specific Accessories

End and intermediate plate; 1 mm thick

orange	2110-1292	100 (25)
gray	2110-1291	100 (25)

Item-Specific Accessories

End and intermediate plate; 1 mm thick

orange	2110-1392	100 (25)
gray	2110-1391	100 (25)

Accessories; 2110 Series

Appropriate marking systems: WMB/WMB Inline/Marking strips

Push-in type jumper bar; insulated; I_N 57 A; light gray

	2-way	2010-402	25
	3-way	2010-403	25
	4-way	2010-404	25
	5-way	2010-405	25

Test plug adapter; for 4 mm Ø test plug

	gray	2009-174	100 (25)
--	------	----------	----------

Push-in type jumper bar; insulated; I_N 57 A; light gray

	1 to 3	2010-433	25
	1 to 4	2010-434	25
	1 to 5	2010-435	25

Testing tap; for max. 2.5 mm²

	gray	2009-182	100 (25)
--	------	----------	----------

Star point jumper; insulated; I_N = I_N terminal block; light gray

	1-3-5	2010-405/011-000	25
--	-------	------------------	----

Marking strip; plain; 11 mm wide; 50 m reel

	white	2009-110	1
--	-------	----------	---

Finger guard; touch-proof cover protects unused conductor entries

	yellow	2010-100	100 (25)
--	--------	----------	----------

WMB marking card; white; 10 strips with 10 markers/card; 5 ... 5.2 mm stretchable

	plain	793-5501	5
--	-------	----------	---

Modular connector; snaps together; for jumper contact slot

	gray	2010-511	50 (25)
--	------	----------	---------

Spacer module; snaps together; bridges commoned terminal blocks

	gray	2010-549	50 (25)
--	------	----------	---------

Through Terminal Block, Ground Conductor Terminal Block TOPJOB® S; with Lever and Push-Button

16 (25 "f-st") mm²; 2116 Series

Technical Data

0.5 ... 16 (25 "f-st") mm ² ①	20 ... 4 AWG
800 V / 8 kV / 3 ②	600 V, 85 A ③
I _N 76 A (90 A)	600 V, 78 A ④
Terminal block width: 12 mm / 0.472 inch	
 18 ... 20 mm / 0.71 ... 0.79 inch	

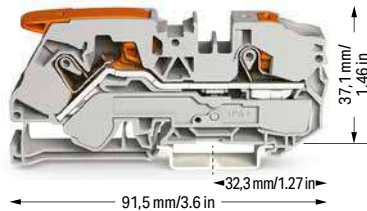

2-conductor through terminal block; with lever and push-button

Color	Item No.	Pack. Unit
gray ⑤	2116-5201 ④	20
blue ⑤	2116-5204 ③ ④	20

2-conductor ground terminal block; with lever and push-button

15 mm high DIN-35 rails shall be used for a current load higher than 76 A!

green-yellow ⑤	2116-5207 ④	20
----------------	-------------	----

Accessories; item-specific

End and intermediate plate; 1 mm thick

 orange	2116-1292	100 (25)
 gray	2116-1291	100 (25)

Accessories; 2116 Series

Appropriate marking systems: WMB/WMB Inline/Marking strips

Push-in type jumper bar; insulated; I_N 76 A; light gray

 2-way	2016-402	25
 3-way	2016-403	25
 4-way	2016-404	25
 5-way	2016-405	25

Push-in type jumper bar; insulated; I_N 76 A; light gray

 1 to 3	2016-433	25
 1 to 4	2016-434	25
 1 to 5	2016-435	25

Star point jumper; insulated; I_N = I_N terminal block; light gray

 1-3-5	2016-405/011-000	25
---	------------------	----

Finger guard; touch-proof cover protects unused conductor entries

 yellow	2016-100	100 (25)
--	----------	----------

Modular connector; snaps together; for jumper contact slot

 gray	2016-511	50 (25)
--	----------	---------

Spacer module; snaps together; bridges commoned terminal blocks

 gray	2016-549	50 (25)
--	----------	---------

Technical Data

0.5 ... 16 (25 "f-st") mm ² ①	20 ... 4 AWG
800 V / 8 kV / 3 ②	600 V, 85 A ③
I _N 76 A (90 A)	600 V, 78 A ④
Terminal block width: 12 mm / 0.472 inch	
 18 ... 20 mm / 0.71 ... 0.79 inch	



3-conductor through terminal block; with lever and push-button

Color	Item No.	Pack. Unit
gray ⑤	2116-5301 ④	20
blue ⑤	2116-5304 ③ ④	20

3-conductor ground terminal block; with lever and push-button

15 mm high DIN-35 rails shall be used for a current load higher than 76 A!

green-yellow ⑤	2116-5307 ④	20
----------------	-------------	----

Accessories; item-specific

End and intermediate plate; 1 mm thick

 orange	2116-1392	100 (25)
 gray	2116-1391	100 (25)

Test plug adapter; for 4 mm Ø test plug

 gray	2009-174	100 (25)
--	----------	----------

Testing tap; for max. 2.5 mm²

 gray	2009-182	100 (25)
--	----------	----------

Marking strip; plain; 11 mm wide; 50 m reel

 white	2009-110	1
---	----------	---

WMB marking card; white; 10 strips with 10 markers/card; 5 ... 5.2 mm stretchable

 plain	793-5501	5
---	----------	---

① Conductor range: 0.5 ... 16 mm² "s+f-st", 25 mm² "f-st"; Push-in termination: 6 ... 16 mm² "s" and 6 ... 16 mm² "insulated ferrules; 18 mm"
Depending on the conductor characteristic, a conductor with a smaller cross section can also be inserted via push-in termination.

② 800 V = rated voltage
8 kV = rated impulse voltage
3 = pollution degree (see Section 15)

③ Terminal blocks with a blue insulated housing are suitable for Ex i applications.

④ Terminal blocks with an Ex mark are suitable for Ex e II applications.
550 V; 76 A
65 A jumper (see Section 15)

Please observe the application notes:
Jumpers, from page 185
Testing accessories, from page 179
Marking, from page 684

Approvals and corresponding ratings, visit www.wago.com

Through Terminal Block, Ground Conductor Terminal Block TOPJOB® S; with Push-Button 1 (1.5) mm²; 2200 Series

1

Technical Data

0.14 ... 1 (1.5) mm ² ①	24 ... 16 AWG
800 V / 8 kV / 3 ②	600 V, 10 A ③
I _N 13.5 A (17.5 A)	600 V, 10 A ④
Terminal block width: 3.5 mm / 0.138 inch	
9 ... 11 mm / 0.35 ... 0.43 inch	

Technical Data

0.14 ... 1 (1.5) mm ² ①	24 ... 16 AWG
800 V / 8 kV / 3 ②	600 V, 10 A ③
I _N 13.5 A (17.5 A)	600 V, 10 A ④
Terminal block width: 3.5 mm / 0.138 inch	
9 ... 11 mm / 0.35 ... 0.43 inch	

Technical Data

0.14 ... 1 (1.5) mm ² ①	24 ... 16 AWG
800 V / 8 kV / 3 ②	600 V, 10 A ③
I _N 13.5 A (17.5 A)	600 V, 10 A ④
Terminal block width: 3.5 mm / 0.138 inch	
9 ... 11 mm / 0.35 ... 0.43 inch	

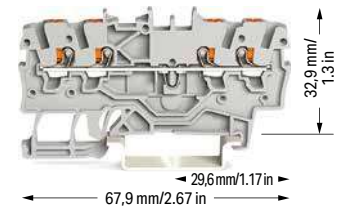
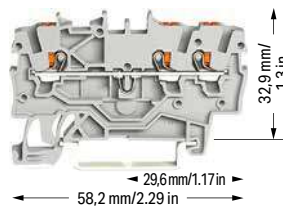
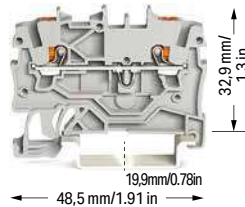

2-conductor through terminal block; with push-button

Color	Item No.	Pack. Unit
gray ⑤	2200-1201 ④	100
blue ⑤	2200-1204 ③ ④	100

3-conductor through terminal block; with push-button

Color	Item No.	Pack. Unit
gray ⑤	2200-1301 ④	100
blue ⑤	2200-1304 ③ ④	100

4-conductor through terminal block; with push-button

Color	Item No.	Pack. Unit
gray ⑤	2200-1401 ④	100
blue ⑤	2200-1404 ③ ④	100

2-conductor ground terminal block; with push-button

green-yellow ⑤	2200-1207 ④	100
----------------	-------------	-----

3-conductor ground terminal block; with push-button

green-yellow ⑤	2200-1307 ④	100
----------------	-------------	-----

4-conductor ground terminal block; with push-button

green-yellow ⑤	2200-1407 ④	100
----------------	-------------	-----

Accessories; item-specific

End and intermediate plate; 0.7 mm thick

orange	2000-1292	100 (25)
gray	2000-1291	100 (25)

Accessories; item-specific

End and intermediate plate; 0.7 mm thick

orange	2000-1392	100 (25)
gray	2000-1391	100 (25)

Accessories; item-specific

End and intermediate plate; 0.7 mm thick

orange	2000-1492	100 (25)
gray	2000-1491	100 (25)

Ex e/Ex i separator; orange; 3 mm thick

90 mm	209-190	50 (25)
120 mm	209-191	50 (25)

Ex e/Ex i separator; orange; 3 mm thick

120 mm	209-191	50 (25)
--------	---------	---------

Ex e/Ex i separator; orange; 3 mm thick

120 mm	209-191	50 (25)
--------	---------	---------

Accessories; 2200 Series

Appropriate marking systems: WMB/WMB Inline/Marking strips

Push-in type jumper bar; insulated; I_N 13.5 A; light gray

2-way	2000-402	25
3-way	2000-403	25
4-way	2000-404	25
5-way	2000-405	25
6-way	2000-406	25
7-way	2000-407	25
8-way	2000-408	25
9-way	2000-409	25
10-way	2000-410	25

Push-in type wire jumper; insulated; 0.75 mm² conductor cross-section; I_N 9 A

L = 60 mm	2009-402	100 (10)
L = 110 mm	2009-404	100 (10)
L = 250 mm	2009-406	100 (10)

Marking strip; plain; 11 mm wide; 50 m reel

white	2009-110	1
-------	----------	---

Push-in type jumper bar; insulated; I_N 13.5 A; light gray

1 to 3	2000-433	25
1 to 4	2000-434	25
1 to 5	2000-435	25
1 to 6	2000-436	25
1 to 7	2000-437	25
1 to 8	2000-438	25
1 to 9	2000-439	25
1 to 10	2000-440	25

Modular connector; snaps together; for jumper contact slot Terminal block width: 5 mm / 0.197 inch

gray	2000-511	100 (25)
------	----------	----------

WMB Inline; plain; 2,300 WMB markers (3.5 mm)/reel

white	2009-113	1
-------	----------	---

Delta jumper; insulated; I_N = I_N terminal block; light gray

1-2-3-4-5-6	2000-406/020-000	25
-------------	------------------	----

Modular connector; snaps together; for jumper contact slot

gray	2000-510	100 (25)
------	----------	----------

WMB marking card; white; 10 strips with 10 markers/card; for 3.5 mm terminal block width

plain	793-3501	5
-------	----------	---

Star point jumper; insulated; I_N = I_N terminal block; light gray

1-3-5	2000-405/011-000	25
-------	------------------	----

Spacer module; snaps together; bridges commoned terminal blocks

gray	2000-549	100 (25)
------	----------	----------

Test plug adapter; for 4 mm Ø test plug

gray	2009-174	100 (25)
------	----------	----------

Testing tap; for max. 2.5 mm²

gray	2009-182	100 (25)
------	----------	----------

① Conductor range: 0.14 ... 1.5 mm² "s+f-st";
Push-in termination: 0.5 ... 1.5 mm² "s" and
0.5 ... 0.75 mm² "insulated ferrules; 10 mm"
Depending on the conductor characteristic, a conductor with a smaller cross section can also be inserted via push-in termination.

② 800 V = rated voltage
8 kV = rated impulse voltage
3 = pollution degree
(see Section 15)

③ Terminal blocks with a blue insulated housing are suitable for Ex i applications.

④ Terminal blocks with an Ex mark are suitable for Ex e II applications.
550 V; 13 A
12 A jumper
(see Section 15)

Please observe the application notes:
Jumpers, from page 182
Testing accessories, from page 176
Marking, from page 684

Approvals and corresponding ratings,
visit www.wago.com

Through Terminal Block, Ground Conductor Terminal Block, Double-Potential Terminal Block TOPJOB® S; with Push-Button

1.5 (2.5) mm²; 2201 Series

Technical Data

0.25 ... 1.5 (2.5) mm ² ①	22 ... 14 AWG
800 V / 8 kV / 3 ②	600 V, 15 A ③
I _N 17.5 A (24 A)	600 V, 15 A ④
Terminal block width: 4.2 mm / 0.165 inch	
9 ... 11 mm / 0.35 ... 0.43 inch	

Technical Data

0.25 ... 1.5 (2.5) mm ² ①	22 ... 14 AWG
800 V / 8 kV / 3 ②	600 V, 15 A ③
I _N 17.5 A (24 A)	600 V, 15 A ④
Terminal block width: 4.2 mm / 0.165 inch	
9 ... 11 mm / 0.35 ... 0.43 inch	

Technical Data

0.25 ... 1.5 (2.5) mm ² ①	22 ... 14 AWG
800 V / 8 kV / 3 ②	600 V, 15 A ③
I _N 17.5 A (24 A)	600 V, 15 A ④
Terminal block width: 4.2 mm / 0.165 inch	
9 ... 11 mm / 0.35 ... 0.43 inch	

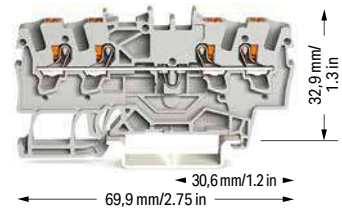
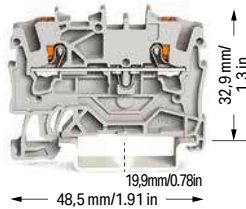

2-conductor through terminal block; with push-button

Color	Item No.	Pack. Unit
gray ⑤	2201-1201 ④	100
blue ⑤	2201-1204 ③ ④	100
dark gray-yellow ⑤	2201-1201/000-053 ④	100

3-conductor through terminal block; with push-button

Color	Item No.	Pack. Unit
gray ⑤	2201-1301 ④	100
blue ⑤	2201-1304 ③ ④	100
orange ⑤	2201-1302 ④	100
dark gray-yellow ⑤	2201-1301/000-053 ④	100

4-conductor through terminal block; with push-button

Color	Item No.	Pack. Unit
gray ⑤	2201-1401 ④	100
blue ⑤	2201-1404 ③ ④	100
dark gray-yellow ⑤	2201-1401/000-053 ④	100

2-conductor ground terminal block; with push-button

green-yellow ⑤	2201-1207 ④	100
----------------	-------------	-----

3-conductor ground terminal block; with push-button

green-yellow ⑤	2201-1307 ④	100
----------------	-------------	-----

4-conductor ground terminal block; with push-button

green-yellow ⑤	2201-1407 ④	100
----------------	-------------	-----

Accessories; item-specific

End and intermediate plate; 0.8 mm thick

orange	2002-1292	100 (25)
gray	2002-1291	100 (25)

Accessories; item-specific

End and intermediate plate; 0.8 mm thick

orange	2002-1392	100 (25)
gray	2002-1391	100 (25)

Accessories; item-specific

End and intermediate plate; 0.8 mm thick

orange	2002-1492	100 (25)
gray	2002-1491	100 (25)

Separator; oversized; 2 mm thick

orange	2002-1294	100 (25)
gray	2002-1293	100 (25)

Separator; oversized; 2 mm thick

orange	2002-1394	100 (25)
gray	2002-1393	100 (25)

Separator; oversized; 2 mm thick

orange	2002-1494	100 (25)
gray	2002-1493	100 (25)

Ex e/Ex i separator; orange; 3 mm thick

90 mm	209-190	50 (25)
120 mm	209-191	50 (25)

Ex e/Ex i separator; orange; 3 mm thick

120 mm	209-191	50 (25)
--------	---------	---------

Ex e/Ex i separator; orange; 3 mm thick

120 mm	209-191	50 (25)
--------	---------	---------

Accessories; 2201 Series

Appropriate marking systems: WMB/WMB Inline/Marking strips

Insulation stop; 5 pcs/strip; 0.25 ... 0.5 mm²

light gray	2001-171	200 (25)
------------	----------	----------

Delta jumper; insulated; I_N = I_N terminal block; light gray

1-2 3-4 5-6	2001-406/020-000	25
-------------	------------------	----

Test plug adapter; for 4 mm Ø test plug

gray	2009-174	100 (25)
------	----------	----------

Push-in type jumper bar; insulated; I_N 17.5 A; light gray

2-way	2001-402	25
3-way	2001-403	25
4-way	2001-404	25
5-way	2001-405	25
6-way	2001-406	25
7-way	2001-407	25
8-way	2001-408	25
9-way	2001-409	25
10-way	2001-410	25

Star point jumper; insulated; I_N = I_N terminal block; light gray

1-3-5	2001-405/011-000	25
-------	------------------	----

Testing tap; for max. 2.5 mm²

gray	2009-182	100 (25)
------	----------	----------

Push-in type wire jumper; insulated; 1.5 mm² conductor cross-section; I_N 18 A

L = 60 mm	2009-412	100 (10)
L = 110 mm	2009-414	100 (10)
L = 250 mm	2009-416	100 (10)

Marking strip; plain; 11 mm wide; 50 m reel

white	2009-110	1
-------	----------	---

Push-in type jumper bar; insulated; I_N 17.5 A; light gray

1 to 3	2001-433	25
1 to 4	2001-434	25
1 to 5	2001-435	25
1 to 6	2001-436	25
1 to 7	2001-437	25
1 to 8	2001-438	25
1 to 9	2001-439	25
1 to 10	2001-440	25

Step-down jumper; insulated; commons 6/4 mm² (10/12 AWG) to 4/2.5/1.5 mm² (12/14/16 AWG); I_N 32 A

light gray	2006-499	25
------------	----------	----

WMB Inline; plain; 2,000 WMB markers (4 mm)/reel; 4 ... 4.2 mm stretchable

white	2009-114	1
-------	----------	---

Modular connector; snaps together; for jumper contact slot

gray	2001-511	100 (25)
------	----------	----------

WMB marking card; white; 10 strips with 10 markers/card; 4 ... 4.2 mm stretchable

plain	793-4501	5
-------	----------	---

① Conductor range: 0.25 ... 2.5 mm² "s+f-st";
Push-in termination: 0.75 ... 2.5 mm² "s" and
0.75 ... 1.5 mm² "insulated ferrules; 12 mm"
Depending on the conductor characteristic, a conduc-
tor with a smaller cross section can also be inserted
via push-in termination.

② 800 V = rated voltage
8 kV = rated impulse voltage
3 = pollution degree
(see Section 15)

③ Terminal blocks with a blue insulated housing are
suitable for Ex i applications.

④ Terminal blocks with an Ex mark are suitable for Ex e II
applications.
550 V; 17.5 A
(see Section 15)

Please observe the application notes:
Jumpers, from page 185
Testing accessories, from page 176
Marking, from page 684

Approvals and corresponding ratings,
visit www.wago.com



**Step-down jumper (2006-499) connects 6/4 mm²
(10/12 AWG) terminal blocks (2206/2204 Series) with
4/2.5/1.5 mm² (AWG 12/14/16) terminal blocks
(2204/2202/2201 Series).**

Through Terminal Block, Ground Conductor Terminal Block, Double-Potential Terminal Block TOPJOB® S; with Push-Button

2.5 (4) mm²; 2202 Series

1

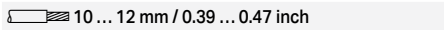
Technical Data	
0.25 ... 2.5 (4) mm ² ①	22 ... 12 AWG
800 V / 8 kV / 3 ②	600 V, 20 A ③
I _N 24 A (32 A)	600 V, 20 A ④
Terminal block width: 5.2 mm / 0.205 inch	
 10 ... 12 mm / 0.39 ... 0.47 inch	

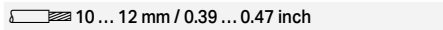
Technical Data	
0.25 ... 2.5 (4) mm ² ①	22 ... 12 AWG
800 V / 8 kV / 3 ②	600 V, 20 A ③
I _N 24 A (32 A)	600 V, 20 A ④
Terminal block width: 5.2 mm / 0.205 inch	
 10 ... 12 mm / 0.39 ... 0.47 inch	

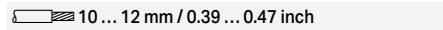
Technical Data	
0.25 ... 2.5 (4) mm ² ①	22 ... 12 AWG
800 V / 8 kV / 3 ②	600 V, 20 A ③
I _N 24 A (32 A)	600 V, 20 A ④
Terminal block width: 5.2 mm / 0.205 inch	
 10 ... 12 mm / 0.39 ... 0.47 inch	

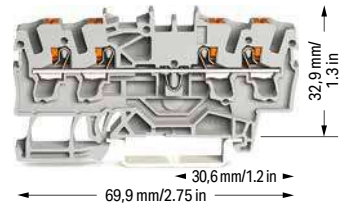
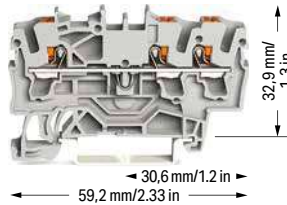
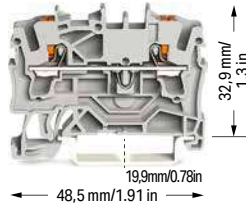

2-conductor through terminal block; with push-button		
Color	Item No.	Pack. Unit
gray ⑤	2202-1201 ④	100
blue ⑤	2202-1204 ③ ④	100
orange ⑤	2202-1202 ④	100
red ⑤	2202-1203 ④	100
black ⑤	2202-1205 ④	100
yellow ⑤	2202-1206 ④	100
black ⑤	2202-1209 ④	100



3-conductor through terminal block; with push-button		
Color	Item No.	Pack. Unit
gray ⑤	2202-1301 ④	100
blue ⑤	2202-1304 ③ ④	100
orange ⑤	2202-1302 ④	100
red ⑤	2202-1303 ④	100
black ⑤	2202-1305 ④	100
yellow ⑤	2202-1306 ④	100
black ⑤	2202-1309 ④	100



4-conductor through terminal block; with push-button		
Color	Item No.	Pack. Unit
gray ⑤	2202-1401 ④	100
blue ⑤	2202-1404 ③ ④	100
orange ⑤	2202-1402 ④	100
red ⑤	2202-1403 ④	100
black ⑤	2202-1405 ④	100
yellow ⑤	2202-1406 ④	100
black ⑤	2202-1409 ④	100



2-conductor ground terminal block; with push-button		
green-yellow ⑤	2202-1207 ④	100



3-conductor ground terminal block; with push-button		
green-yellow ⑤	2202-1307 ④	100



4-conductor ground terminal block; with push-button		
green-yellow ⑤	2202-1407 ④	100

Accessories; item-specific			
End and intermediate plate; 0.8 mm thick			
	orange	2002-1292	100 (25)
	gray	2002-1291	100 (25)



Accessories; item-specific			
End and intermediate plate; 0.8 mm thick			
	orange	2002-1392	100 (25)
	gray	2002-1391	100 (25)

Accessories; item-specific			
End and intermediate plate; 0.8 mm thick			
	orange	2002-1492	100 (25)
	gray	2002-1491	100 (25)

Separator; oversized; 2 mm thick			
	orange	2002-1294	100 (25)
	gray	2002-1293	100 (25)

Separator; oversized; 2 mm thick			
	orange	2002-1394	100 (25)
	gray	2002-1393	100 (25)

Separator; oversized; 2 mm thick			
	orange	2002-1494	100 (25)
	gray	2002-1493	100 (25)

Ex e/Ex i separator; orange; 3 mm thick			
	90 mm	209-190	50 (25)
	120 mm	209-191	50 (25)









Ex e/Ex i separator; orange; 3 mm thick			
	120 mm	209-191	50 (25)



Ex e/Ex i separator; orange; 3 mm thick			
	120 mm	209-191	50 (25)

Accessories; 2202 Series



Appropriate marking systems: WMB/WMB Inline/Marking strips









Insulation stop; 5 pcs/strip; 0.25 ... 0.5 mm ²			
	light gray	2002-171	200 (25)

Push-in type jumper bar; insulated; I _N 25 A; light gray			
	1 to 3	2002-433	25
	1 to 4	2002-434	25
	1 to 5	2002-435	25
	1 to 6	2002-436	25
	1 to 7	2002-437	25
	1 to 8	2002-438	25
	1 to 9	2002-439	25
	1 to 10	2002-440	25











Continuous jumper; insulated; I _N 25 A; light gray			
	1 to 3	2002-423	25
	1 to 4	2002-424	25

Insulation stop; 5 pcs/strip; 0.75 ... 1 mm ²			
	dark gray	2002-172	200 (25)

Continuous jumper; insulated; I _N 25 A; light gray			
	3-way	2002-413	25
	5-way	2002-415	25

Push-in type jumper bar; insulated; I _N 25 A; light gray			
	2-way	2002-402	25
	3-way	2002-403	25
	4-way	2002-404	25
	5-way	2002-405	25
	6-way	2002-406	25
	7-way	2002-407	25
	8-way	2002-408	25
	9-way	2002-409	25
	10-way	2002-410	25

Delta jumper; insulated; I _N = I _N terminal block; light gray			
	1-2 3-4 5-6	2002-406/020-000	25

Staggered jumper; insulated; I _N 25 A; light gray			
	2-way	2002-472	25
	3-way	2002-473	25
	4-way	2002-474	25
	5-way	2002-475	25
	6-way	2002-476	25
	7-way	2002-477	25
	8-way	2002-478	25
	9-way	2002-479	25
	10-way	2002-480	25
	11-way	2002-481	25
	12-way	2002-482	25

Star point jumper; insulated; I _N = I _N terminal block; light gray			
	1-3-5	2002-405/011-000	25

Continuous jumper; insulated; I _N 25 A; light gray			
	2-way	2002-400	25

① Conductor range: 0.25 ... 4 mm² "s+f-st";
Push-in termination: 1 ... 4 mm² "s" and 1 ... 2.5 mm²
"insulated ferrules, 12 mm"
Depending on the conductor characteristic, a conductor with a smaller cross section can also be inserted via push-in termination.

② 800 V = rated voltage
8 kV = rated impulse voltage
3 = pollution degree
(see Section 15)

③ Terminal blocks with a blue insulated housing are suitable for Ex i applications.

④ Terminal blocks with an Ex mark are suitable for Ex e II applications.
550 V; 22 A
20 A jumper
(see Section 15)

Please observe the application notes:
Jumpers, from page 182
Testing accessories, from page 177
Marking, from page 684

Approvals and corresponding ratings,
visit www.wago.com

Accessories; 2202 Series

Appropriate marking systems:
WMB/WMB Inline/Marking strips

Step-down jumper; insulated; commons 6/4 mm²
(10/12 AWG) to 4/2.5/1.5 mm² (12/14/16 AWG); I_N 32 A



light gray 2006-499 25

Push-in type wire jumper; insulated; 1.5 mm² conductor cross-section; I_N 18 A



L = 60 mm 2009-412 100 (10)

L = 110 mm 2009-414 100 (10)

L = 250 mm 2009-416 100 (10)

Modular connector; snaps together; for jumper contact slot



gray 2002-511 100 (25)

L-type test plug module; snaps together



gray 2002-611 100 (25)

Test plug adapter; for 4 mm Ø test plug



gray 2009-174 100 (25)

Testing tap; for max. 2.5 mm²



gray 2009-182 100 (25)

Marking strip; plain; 11 mm wide; 50 m reel



white 2009-110 1

WMB Inline, plain; 1,500 WMB markers (5 mm)/reel;
5 ... 5.2 mm stretchable



white 2009-115 1

WMB marking card; white; 10 strips with 10 markers/card;
5 ... 5.2 mm stretchable



plain 793-5501 5



Step-down jumper (2006-499) commons 6/4 mm²
(10/12 AWG) terminal blocks (2206/2204 Series) with
4/2.5/1.5 mm² (AWG 12/14/16) terminal blocks
(2204/2202/2201 Series).

Through Terminal Block, Ground Conductor Terminal Block, TOPJOB® S; with Push-Button 2.5 (4) mm²; 2202 Series

1

Technical Data

0.25 ... 2.5 (4) mm ² ①	22 ... 12 AWG
800 V / 8 kV / 3 ②	600 V, 20 A ③
I _N 24 A (32 A)	600 V, 20 A ④
Terminal block width: 5.2 mm / 0.205 inch	
 10 ... 12 mm / 0.39 ... 0.47 inch	



3-conductor through terminal block; with push-button

Color	Item No.	Pack. Unit
gray	2202-6301 ④	100
blue	2202-6304 ③ ④	100
orange	2202-6302 ④	100
red	2202-6303 ④	100
black	2202-6305 ④	100
yellow	2202-6306 ④	100

3-conductor ground terminal block; with push-button

green-yellow	2202-6307 ④	100
--------------	-------------	-----

Accessories; 2202 Series

Appropriate marking systems:
WMB/WMB Inline/Marking strips

End and intermediate plate; 0.8 mm thick

 orange	2002-6392	100 (25)
gray	2002-6391	100 (25)

Insulation stop; 5 pcs/strip; 0.25 ... 0.5 mm²

 light gray	2002-171	200 (25)
--	----------	----------

Insulation stop; 5 pcs/strip; 0.75 ... 1 mm²

 dark gray	2002-172	200 (25)
---	----------	----------

Push-in type jumper bar; insulated; I_N 25 A; light gray

 2-way	2002-402	25
3-way	2002-403	25
4-way	2002-404	25
5-way	2002-405	25
6-way	2002-406	25
7-way	2002-407	25
8-way	2002-408	25
9-way	2002-409	25
10-way	2002-410	25

Delta jumper; insulated; I_N = I_N terminal block; light gray

 1-2 3-4 5-6	2002-406/020-000	25
---	------------------	----

Star point jumper; insulated; I_N = I_N terminal block; light gray

 1-3-5	2002-405/011-000	25
---	------------------	----

① Conductor range: 0.25 ... 4 mm² "s+f-st";
Push-in termination: 1 ... 4 mm² "s" and 1 ... 2.5 mm² "insulated ferrules, 12 mm"
Depending on the conductor characteristic, a conductor with a smaller cross section can also be inserted via push-in termination.

② 800 V = rated voltage
8 kV = rated impulse voltage
3 = pollution degree
(see Section 15)

③ Terminal blocks with a blue insulated housing are suitable for Ex i applications.

④ Terminal blocks with an Ex mark are suitable for Ex e II applications.
550 V; 21 A
20 A jumper
(see Section 15)

Please observe the application notes:
Jumpers, from page 182
Testing accessories, from page 177
Marking, from page 684

Approvals and corresponding ratings,
visit www.wago.com

Accessories; 2202 Series

Appropriate marking systems:
WMB/WMB Inline/Marking strips

Continuous jumper; insulated; I_N 25 A; light gray

 2-way	2002-400	25
--	----------	----

Push-in type jumper bar; insulated; I_N 25 A; light gray

 1 to 3	2002-433	25
1 to 4	2002-434	25
1 to 5	2002-435	25
1 to 6	2002-436	25
1 to 7	2002-437	25
1 to 8	2002-438	25
1 to 9	2002-439	25
1 to 10	2002-440	25

Staggered jumper; insulated; I_N 25 A; light gray

 2-way	2002-472	25
3-way	2002-473	25
4-way	2002-474	25
5-way	2002-475	25
6-way	2002-476	25
7-way	2002-477	25
8-way	2002-478	25
9-way	2002-479	25
10-way	2002-480	25
11-way	2002-481	25
12-way	2002-482	25

Customized staggered jumper; insulated; with contact lugs broken off at the factory and circuit printing; I_N 25 A; light gray

 1-3	2002-473/011-000	25
1-3-5	2002-475/011-000	25
1-3-5-7	2002-477/011-000	25
1-3-5-7-9	2002-479/011-000	25
1-3-5-7-9-11	2002-481/011-000	25

Continuous jumper; insulated; I_N 25 A; 1 to 3

 light gray	2002-423	25
red	2002-423/000-005	25
blue	2002-423/000-006	25

Push-in type wire jumper; insulated; 1.5 mm² conductor cross-section; I_N 18 A

 L = 60 mm	2009-412	100 (10)
L = 110 mm	2009-414	100 (10)
L = 250 mm	2009-416	100 (10)

Accessories; 2202 Series

Appropriate marking systems:
WMB/WMB Inline/Marking strips

Modular connector; snaps together; for jumper contact slot

 gray	2002-511	100 (25)
--	----------	----------

Spacer module; snaps together; bridges commoned terminal blocks

 gray	2002-549	100 (25)
--	----------	----------

L-type test plug module; snaps together

 gray	2002-611	100 (25)
--	----------	----------

L-type spacer module; snaps together; bridges commoned terminal blocks

 gray	2002-649	100 (25)
--	----------	----------

Test plug adapter; for 4 mm Ø test plug

 gray	2009-174	100 (25)
--	----------	----------

Testing tap; for max. 2.5 mm²

 gray	2009-182	100 (25)
---	----------	----------

Marking strip; plain; 11 mm wide; 50 m reel

 white	2009-110	1
---	----------	---

WMB Inline, plain; 1,500 WMB markers (5 mm)/reel; 5 ... 5.2 mm stretchable

 white	2009-115	1
---	----------	---

WMB marking card; white; 10 strips with 10 markers/card; 5 ... 5.2 mm stretchable

 plain	793-5501	5
---	----------	---

Through Terminal Block, Ground Conductor Terminal Block TOPJOB® S; with Push-Button 2.5 (4) mm²; 2202 Series

Technical Data

0.25 ... 2.5 (4) mm² ① | 22 ... 12 AWG

800 V / 8 kV / 3 ① | 600 V, 20 A ②

I_N 24 A (32 A) | 600 V, 20 A ③

Terminal block width: 5.2 mm / 0.205 inch

10 ... 12 mm / 0.39 ... 0.47 inch

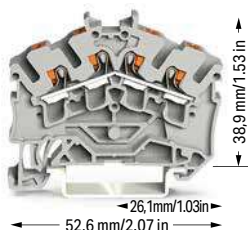

4-conductor through terminal block; with push-button
Notice: This terminal block cannot be commoned with push-in type jumper bars!

Color	Item No.	Pack. Unit
gray	2202-6401 ④	100
blue	2202-6404 ③ ④	100
orange	2202-6402 ①	100
red	2202-6403 ①	100
black	2202-6405 ①	100
yellow	2202-6406 ①	100

4-conductor ground terminal block; with push-button

green-yellow	2202-6407 ④	100
--------------	-------------	-----

Accessories; 2202 Series

Appropriate marking systems:
WMB/WMB Inline/Marking strips

End and intermediate plate; 0.8 mm thick

orange	2002-6392	100 (25)
gray	2002-6391	100 (25)

Insulation stop; 5 pcs/strip; 0.25 ... 0.5 mm²

light gray	2002-171	200 (25)
------------	----------	----------

Insulation stop; 5 pcs/strip; 0.75 ... 1 mm²

dark gray	2002-172	200 (25)
-----------	----------	----------

Marking strip; plain; 11 mm wide; 50 m reel

white	2009-110	1
-------	----------	---

WMB Inline, plain; 1,500 WMB markers (5 mm)/reel;
5 ... 5.2 mm stretchable

white	2009-115	1
-------	----------	---

WMB marking card; white; 10 strips with 10 markers/card;
5 ... 5.2 mm stretchable

plain	793-5501	5
-------	----------	---

① Conductor range: 0.25 ... 4 mm² "s+f-st";
Push-in termination: 1 ... 4 mm² "s" and 1 ... 2.5 mm²
"insulated ferrules, 12 mm"
Depending on the conductor characteristic, a conductor with a smaller cross section can also be inserted via push-in termination.

② 800 V = rated voltage
8 kV = rated impulse voltage
3 = pollution degree
(see Section 15)

③ Terminal blocks with a blue insulated housing are suitable for Ex i applications.

④ Terminal blocks with an Ex mark are suitable for Ex e II applications.
550 V; 21 A
20 A jumper
(see Section 15)

Please observe the application notes:
Marking, from page 684

Approvals and corresponding ratings,
visit www.wago.com



3- and 4-conductor terminal blocks (angled type):
WAGO's Rail-Mount Terminal Blocks TOPJOB® S have a 35-degree conductor entry angle permitting a very small bend radius and an extremely short wiring distance to the cable duct. These are space- and cost-saving solutions for switchgear and control cabinet applications that use the LSC wiring system from Lütze. The design allows cable duct to be placed very close to the terminal blocks, keeping its height relatively low.

Product features:

- Push-in CAGE CLAMP® connection for all conductor types, with the additional benefit of solid, stranded and fine-stranded conductors with ferrules being simply pushed in
- Vibration-proof, fast, maintenance-free
- 3-conductor through and ground conductor terminal blocks equipped with a dual jumper slot
- 4-conductor terminal blocks permit potential multiplication – no additional jumpers or terminal blocks needed
- 3- and 4-conductor terminal blocks have the same dimensions.
- An end plate must be applied when changing from a 3-conductor terminal block to a 4-conductor terminal block and vice versa.

Through Terminal Block, Ground Conductor Terminal Block TOPJOB® S; with Push-Button 4 (6) mm²; 2204 Series

1

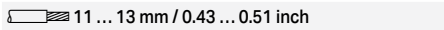
Technical Data	
0.5 ... 4 (6) mm ² ①	20 ... 10 AWG
800 V / 8 kV / 3 ②	600 V, 30 A ③
I _N 32 A (41 A)	600 V, 30 A ④
Terminal block width: 6.2 mm / 0.244 inch	
 11 ... 13 mm / 0.43 ... 0.51 inch	

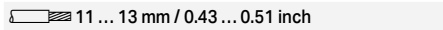
Technical Data	
0.5 ... 4 (6) mm ² ①	20 ... 10 AWG
800 V / 8 kV / 3 ②	600 V, 30 A ③
I _N 32 A (41 A)	600 V, 30 A ④
Terminal block width: 6.2 mm / 0.244 inch	
 11 ... 13 mm / 0.43 ... 0.51 inch	

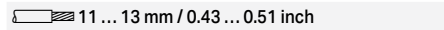
Technical Data	
0.5 ... 4 (6) mm ² ①	20 ... 10 AWG
800 V / 8 kV / 3 ②	600 V, 30 A ③
I _N 32 A (41 A)	600 V, 30 A ④
Terminal block width: 6.2 mm / 0.244 inch	
 11 ... 13 mm / 0.43 ... 0.51 inch	

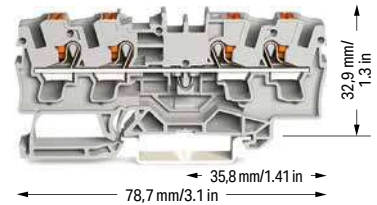
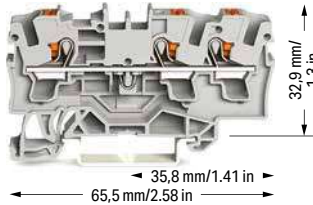
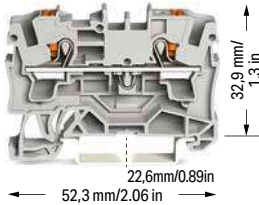

2-conductor through terminal block; with push-button		
Color	Item No.	Pack. Unit
gray ⑤	2204-1201 ④	50
blue ⑤	2204-1204 ③ ④	50
orange ⑤	2204-1202 ④	50
red ⑤	2204-1203 ④	50
black ⑤	2204-1205 ④	50
yellow ⑤	2204-1206 ④	50
light gray ⑤	2204-1209 ④	50

3-conductor through terminal block; with push-button		
Color	Item No.	Pack. Unit
gray ⑤	2204-1301 ④	50
blue ⑤	2204-1304 ③ ④	50
orange ⑤	2204-1302 ④	50
red ⑤	2204-1303 ④	50
black ⑤	2204-1305 ④	50
yellow ⑤	2204-1306 ④	50
light gray ⑤	2204-1309 ④	50



4-conductor through terminal block; with push-button		
Color	Item No.	Pack. Unit
gray ⑤	2204-1401 ④	50
blue ⑤	2204-1404 ③ ④	50
orange ⑤	2204-1402 ④	50
red ⑤	2204-1403 ④	50
black ⑤	2204-1405 ④	50
yellow ⑤	2204-1406 ④	50
light gray ⑤	2204-1409 ④	50



2-conductor ground terminal block; with push-button		
green-yellow ⑤	2204-1207 ④	50



3-conductor ground terminal block; with push-button		
green-yellow ⑤	2204-1307 ④	50



4-conductor ground terminal block; with push-button		
green-yellow ⑤	2204-1407 ④	50

Accessories; item-specific			
End and intermediate plate; 1 mm thick			
	orange	2004-1292	100 (25)
	gray	2004-1291	100 (25)



Accessories; item-specific			
End and intermediate plate; 1 mm thick			
	orange	2004-1392	100 (25)
	gray	2004-1391	100 (25)

Accessories; item-specific			
End and intermediate plate; 1 mm thick			
	orange	2004-1492	100 (25)
	gray	2004-1491	100 (25)

Separator; oversized; 2 mm thick			
	orange	2004-1294	100 (25)
	gray	2004-1293	100 (25)

Separator; oversized; 2 mm thick			
	orange	2004-1394	100 (25)
	gray	2004-1393	100 (25)

Separator; oversized; 2 mm thick			
	orange	2004-1494	100 (25)
	gray	2004-1493	100 (25)

Ex e/Ex i separator; orange; 3 mm thick			
	90 mm	209-190	50 (25)
	120 mm	209-191	50 (25)









Ex e/Ex i separator; orange; 3 mm thick			
	120 mm	209-191	50 (25)

Ex e/Ex i separator; orange; 3 mm thick			
	120 mm	209-191	50 (25)

Accessories; 2204 Series

Appropriate marking systems: WMB/WMB Inline/Marking strips

Insulation stop; 5 pcs/strip; 0.25 ... 0.5 mm ²			
	light gray	2004-171	200 (25)









Push-in type jumper bar; insulated; I _N 32 A; light gray			
	1 to 3	2004-433	25
	1 to 4	2004-434	25
	1 to 5	2004-435	25
	1 to 6	2004-436	25
	1 to 7	2004-437	25
	1 to 8	2004-438	25
	1 to 9	2004-439	25
	1 to 10	2004-440	25

Step-down jumper; insulated; commons 6/4 mm ² (10/12 AWG) to 4/2.5/1.5 mm ² (12/14/16 AWG); I _N 32 A			
	light gray	2006-499	25

Insulation stop; 5 pcs/strip; 0.75 ... 1 mm ²			
	dark gray	2004-172	200 (25)

Star point jumper; insulated; I _N = I _N terminal block; light gray			
	1-3-5	2004-405/011-000	25

Modular connector; snaps together; for jumper contact slot			
	gray	2004-511	100 (25)

Push-in type jumper bar; insulated; I _N 32 A; light gray			
	2-way	2004-402	25
	3-way	2004-403	25
	4-way	2004-404	25
	5-way	2004-405	25
	6-way	2004-406	25
	7-way	2004-407	25
	8-way	2004-408	25
	9-way	2004-409	25
	10-way	2004-410	25

Delta jumper; insulated; I _N = I _N terminal block; light gray			
	1-2-3-4-5-6	2004-406/020-000	

Test plug adapter; for 4 mm Ø test plug			
	gray	2009-174	100 (25)

Testing tap; for max. 2.5 mm ²			
	gray	2009-182	100 (25)

① Conductor range: 0.5 ... 6 mm² "s+f-st";
 Push-in termination: 1.5 ... 6 mm² "s" and 1.5 ... 4 mm²
 "insulated ferrules; 12 mm"
 Depending on the conductor characteristic, a conductor with a smaller cross section can also be inserted via push-in termination.

② 800 V = rated voltage
 8 kV = rated impulse voltage
 3 = pollution degree
 (see Section 15)

③ Terminal blocks with a blue insulated housing are suitable for Ex i applications.

④ Terminal blocks with an Ex mark are suitable for Ex e II applications.
 550 V; 31 A
 30 A jumper
 (see Section 15)

Please observe the application notes:
 Jumpers, from page 185
 Testing accessories, from page 178
 Marking, from page 684

Approvals and corresponding ratings,
 visit www.wago.com



Step-down jumper (2006-499) commons 6/4 mm² (10/12 AWG) terminal blocks (2206/2204 Series) with 4/2.5/1.5 mm² (AWG 12/14/16) terminal blocks (2204/2202/2201 Series).

Through Terminal Block, Ground Conductor Terminal Block TOPJOB® S; with Push-Button 6 (10) mm²; 2206 Series

1

Technical Data

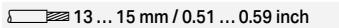
0.5 ... 6 (10) mm ² ①	20 ... 8 AWG
800 V / 8 kV / 3 ②	600 V, 50 A ③
I _N 41 A (57 A)	600 V, 50 A ④
Terminal block width: 7.5 mm / 0.295 inch	
 13 ... 15 mm / 0.51 ... 0.59 inch	

Technical Data

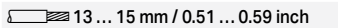
0.5 ... 6 (10) mm ² ①	20 ... 8 AWG
800 V / 8 kV / 3 ②	600 V, 50 A ③
I _N 41 A (57 A)	600 V, 50 A ④
Terminal block width: 7.5 mm / 0.295 inch	
 13 ... 15 mm / 0.51 ... 0.59 inch	

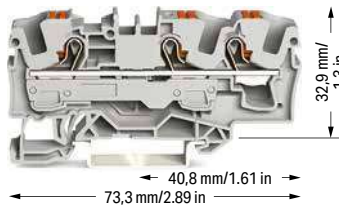
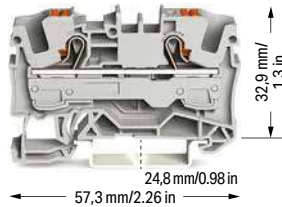

2-conductor through terminal block; with push-button

Color	Item No.	Pack. Unit
gray ⑤	2206-1201 ④	50
blue ⑤	2206-1204 ③ ④	50

3-conductor through terminal block; with push-button

Color	Item No.	Pack. Unit
gray ⑤	2206-1301 ④	25
blue ⑤	2206-1304 ③ ④	25
red ⑤	2206-1303 ④	25
black ⑤	2206-1305 ④	25

2-conductor ground terminal block; with push-button

green-yellow ⑤	2206-1207 ④	50
----------------	-------------	----

3-conductor ground terminal block; with push-button

green-yellow ⑤	2206-1307 ④	25
----------------	-------------	----

Accessories; item-specific

End and intermediate plate; 1 mm thick

	orange	2006-1292	100 (25)
	gray	2006-1291	100 (25)

Accessories; item-specific

End and intermediate plate; 1 mm thick

	orange	2006-1392	100 (25)
	gray	2006-1391	100 (25)

Separator; oversized; 2 mm thick

	orange	2006-1294	100 (25)
	gray	2006-1293	100 (25)

Separator; oversized; 2 mm thick

	orange	2006-1394	100 (25)
	gray	2006-1393	100 (25)

Accessories; 2206 Series

Appropriate marking systems: WMB/WMB Inline/Marking strips

Ex e/Ex i separator; orange; 3 mm thick

	120 mm	209-191	50 (25)
--	--------	---------	---------

Spacer module; snaps together; bridges commoned terminal blocks

	gray	2006-549	50 (25)
---	------	----------	---------

Push-in type jumper bar; insulated; I_N 41 A; light gray

	2-way	2006-402	25
	3-way	2006-403	25
	4-way	2006-404	25
	5-way	2006-405	25

Test plug adapter; for 4 mm Ø test plug

	gray	2009-174	100 (25)
---	------	----------	----------

Push-in type jumper bar; insulated; I_N 41 A; light gray

	1 to 3	2006-433	25
	1 to 4	2006-434	25
	1 to 5	2006-435	25

Testing tap; for max. 2.5 mm²

	gray	2009-182	100 (25)
---	------	----------	----------

Star point jumper; insulated; I_N = I_N terminal block; light gray

	1-3-5	2006-405/011-000	25
---	-------	------------------	----

Marking strip; plain; 11 mm wide; 50 m reel

	white	2009-110	1
---	-------	----------	---

Step-down jumper; insulated; commons 6/4 mm² (10/12 AWG) to 4/2.5/1.5 mm² (12/14/16 AWG); I_N 32 A

	light gray	2006-499	25
---	------------	----------	----

WMB marking card; white; 10 strips with 10 markers/card; 5 ... 5.2 mm stretchable

	plain	793-5501	5
---	-------	----------	---

Modular connector; snaps together; for jumper contact slot

	gray	2006-511	50 (25)
---	------	----------	---------

① Conductor range: 0.5 ... 10 mm² "s+f-st"; Push-in termination: 2.5 ... 10 mm² "s" and 2.5 ... 6 mm² "insulated ferrules; 12 mm" Depending on the conductor characteristic, a conductor with a smaller cross section can also be inserted via push-in termination.

② 800 V = rated voltage
8 kV = rated impulse voltage
3 = pollution degree (see Section 15)

③ Terminal blocks with a blue insulated housing are suitable for Ex i applications.

④ Terminal blocks with an Ex mark are suitable for Ex e II applications.
550 V; 41 A
33 A jumper (see Section 15)

Please observe the application notes:
Jumpers, from page 185
Testing accessories, from page 178
Marking, from page 684

Approvals and corresponding ratings, visit www.wago.com



Step-down jumper (2006-499) commons 6/4 mm² (10/12 AWG) terminal blocks (2206/2204 Series) with 4/2.5/1.5 mm² (AWG 12/14/16) terminal blocks (2204/2202/2201 Series).

Through Terminal Block, Ground Conductor Terminal Block TOPJOB® S; with Push-Button 10 (16) mm²; 2210 Series

Technical Data

0,5 ... 10 (16) mm ² ①	20 ... 6 AWG
800 V / 8 kV / 3 ②	600 V, 65 A ③
I _N 57 A (76 A)	600 V, 64 A ④
Terminal block width: 10 mm / 0.394 inch	
 17 ... 19 mm / 0.67 ... 0.75 inch	

Technical Data

0,5 ... 10 (16) mm ² ①	20 ... 6 AWG
800 V / 8 kV / 3 ②	600 V, 65 A ③
I _N 57 A (76 A)	600 V, 64 A ④
Terminal block width: 10 mm / 0.394 inch	
 17 ... 19 mm / 0.67 ... 0.75 inch	



2-conductor through terminal block; with push-button

Color	Item No.	Pack. Unit
gray ⑤	2210-1201 ④	25
blue ⑤	2210-1204 ③ ④	25
red ⑤	2210-1203 ④	25
black ⑤	2210-1205 ④	25

3-conductor through terminal block; with push-button

Color	Item No.	Pack. Unit
gray ⑤	2210-1301 ④	25
blue ⑤	2210-1304 ③ ④	25
red ⑤	2210-1303 ④	25
black ⑤	2210-1305 ④	25

2-conductor ground terminal block; with push-button

green-yellow ⑤	2210-1207 ④	25
----------------	-------------	----

3-conductor ground terminal block; with push-button

green-yellow ⑤	2210-1307 ④	25
----------------	-------------	----

Accessories; item-specific

End and intermediate plate; 1 mm thick

	orange	2010-1292	100 (25)
	gray	2010-1291	100 (25)

Accessories; item-specific

End and intermediate plate; 1 mm thick

	orange	2010-1392	100 (25)
	gray	2010-1391	100 (25)

Accessories; 2210 Series

Appropriate marking systems: WMB/WMB Inline/Marking strips

Ex e/Ex i separator; orange; 3 mm thick

	120 mm	209-191	50 (25)
---	--------	---------	---------

Spacer module; snaps together; bridges commoned terminal blocks

	gray	2010-549	50 (25)
---	------	----------	---------

Push-in type jumper bar; insulated; I_N 57 A; light gray

	2-way	2010-402	25
	3-way	2010-403	25
	4-way	2010-404	25
	5-way	2010-405	25

Test plug adapter; for 4 mm Ø test plug

	gray	2009-174	100 (25)
---	------	----------	----------

Push-in type jumper bar; insulated; I_N 57 A; light gray

	1 to 3	2010-433	25
	1 to 4	2010-434	25
	1 to 5	2010-435	25

Testing tap; for max. 2.5 mm²

	gray	2009-182	100 (25)
---	------	----------	----------

Star point jumper; insulated; I_N = I_N terminal block; light gray

	1-3-5	2010-405/011-000	25
---	-------	------------------	----

Marking strip; plain; 11 mm wide; 50 m reel

	white	2009-110	1
---	-------	----------	---

Step-down jumper; insulated; commons 16/10 mm² (8/10 AWG) to 10/6/4/2.5 mm² (8/10/12/14 AWG); I_N 57 A

	light gray	2016-499	25
---	------------	----------	----

WMB marking card; white; 10 strips with 10 markers/card; 5 ... 5.2 mm stretchable

	plain	793-5501	5
---	-------	----------	---

Finger guard; touch-proof cover protects unused conductor entries

	yellow	2010-100	100 (25)
---	--------	----------	----------

Modular connector; snaps together; for jumper contact slot

	gray	2010-511	50 (25)
---	------	----------	---------

① Conductor range: 0.5 ... 16 mm² "s+f-st"; Push-in termination: 4 ... 16 mm² "s" and 4 ... 10 mm² "insulated ferrules; 18 mm"
Depending on the conductor characteristic, a conductor with a smaller cross section can also be inserted via push-in termination.

② 800 V = rated voltage
8 kV = rated impulse voltage
3 = pollution degree (see Section 15)

③ Terminal blocks with a blue insulated housing are suitable for Ex i applications.

④ Terminal blocks with an Ex mark are suitable for Ex e II applications.
550 V; 54 A
50 A jumper (see Section 15)

Please observe the application notes:
Jumpers, from page 185
Testing accessories, from page 178
Marking, from page 684

Approvals and corresponding ratings, visit www.wago.com





Through Terminal Block, Ground Conductor Terminal Block TOPJOB® S; with Push-Button 16 (25 "f-st") mm²; 2216 Series

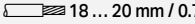



1

Technical Data	
0.5 ... 16 (25 "f-st") mm ² ①	20 ... 4 AWG
800 V / 8 kV / 3 ②	600 V, 85 A ③
I _N 76 A (90 A)	600 V, 85 A ④
Terminal block width: 12 mm / 0.472 inch	
 18 ... 20 mm / 0.71 ... 0.79 inch	

Technical Data	
0.5 ... 16 (25 "f-st") mm ² ①	20 ... 4 AWG
800 V / 8 kV / 3 ②	600 V, 85 A ③
I _N 76 A (90 A)	600 V, 85 A ④
Terminal block width: 12 mm / 0.472 inch	
 18 ... 20 mm / 0.71 ... 0.79 inch	







2-conductor through terminal block; with push-button		
Color	Item No.	Pack. Unit
 gray ⑤	2216-1201 ④	20
 blue ⑤	2216-1204 ③ ④	20
 red ⑤	2216-1203 ④	20
 black ⑤	2216-1205 ④	20

3-conductor through terminal block; with push-button		
Color	Item No.	Pack. Unit
 gray ⑤	2216-1301 ④	20
 blue ⑤	2216-1304 ③ ④	20
 red ⑤	2216-1303 ④	20
 black ⑤	2216-1305 ④	20

2-conductor ground terminal block; with push-button 15 mm high DIN-35 rails shall be used for a current load higher than 76 A!		
 green-yellow ⑤	2216-1207 ④	50

3-conductor ground terminal block; with push-button 15 mm high DIN-35 rails shall be used for a current load higher than 76 A!		
 green-yellow ⑤	2216-1307 ④	20





Accessories; item-specific			
End and intermediate plate; 1 mm thick			
	orange	2016-1292	100 (25)
	gray	2016-1291	100 (25)

Accessories; item-specific			
End and intermediate plate; 1 mm thick			
	orange	2016-1392	100 (25)
	gray	2016-1391	100 (25)



Accessories; 2216 Series
Appropriate marking systems: WMB/WMB Inline/Marking strips

Ex e/Ex i separator; orange; 3 mm thick			
	120 mm	209-191	50 (25)

Modular connector; snaps together; for jumper contact slot			
	gray	2016-511	50 (25)

Push-in type jumper bar; insulated; I _N 76 A; light gray			
	2-way	2016-402	25
	3-way	2016-403	25
	4-way	2016-404	25
	5-way	2016-405	25

Spacer module; snaps together; bridges commoned terminal blocks			
	gray	2016-549	50 (25)

Push-in type jumper bar; insulated; I _N 76 A; light gray			
	1 to 3	2016-433	25
	1 to 4	2016-434	25
	1 to 5	2016-435	25

Test plug adapter; for 4 mm Ø test plug			
	gray	2009-174	100 (25)

Star point jumper; insulated; I _N = I _N terminal block; light gray			
	1-3-5	2016-405/011-000	25

Testing tap; for max. 2.5 mm ²			
	gray	2009-182	100 (25)

Step-down jumper; insulated; commons 16/10 mm ² (8/10 AWG) to 10/6/4/2.5 mm ² (8/10/12/14 AWG); I _N 57 A			
	light gray	2016-499	25

Marking strip; plain; 11 mm wide; 50 m reel			
	white	2009-110	1

Finger guard; touch-proof cover protects unused conductor entries			
	yellow	2016-100	100 (25)

WMB marking card; white; 10 strips with 10 markers/card; 5 ... 5.2 mm stretchable			
	plain	793-5501	5

- ① Conductor range: 0.5 ... 16 mm² "s+f-st", 25 mm² "f-st"; Push-in termination: 6 ... 16 mm² "s" and 6 ... 16 mm² "insulated ferrules; 18 mm"
Depending on the conductor characteristic, a conductor with a smaller cross section can also be inserted via push-in termination.
- ② 800 V = rated voltage
8 kV = rated impulse voltage
3 = pollution degree (see Section 15)
- ③ Terminal blocks with a blue insulated housing are suitable for Ex i applications.
- ④ Terminal blocks with an Ex mark are suitable for Ex e II applications.
550 V; 76 A
65 A jumper (see Section 15)

Please observe the application notes:
Jumpers, from page 185
Testing accessories, from page 179
Marking, from page 684

Approvals and corresponding ratings, visit www.wago.com

Rail-Mount Terminal Blocks TOPJOB® S; with Push-in CAGE CLAMP®

2000 to 2016 Series

Description and Installation

1



Push-in termination of solid and ferruled conductors

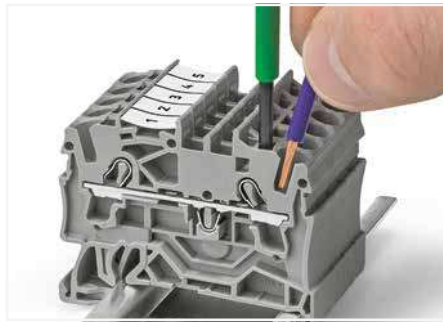

Insert fine-stranded conductors via operating tool.

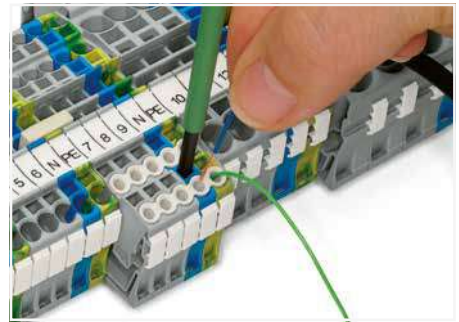

Conductor termination – insulation stop



Insert push-in type jumper bar and push down until it hits backstop.



Custom jumpers are created by breaking and removing jumper contacts (2000, 2001, 2002, 2004 Series).

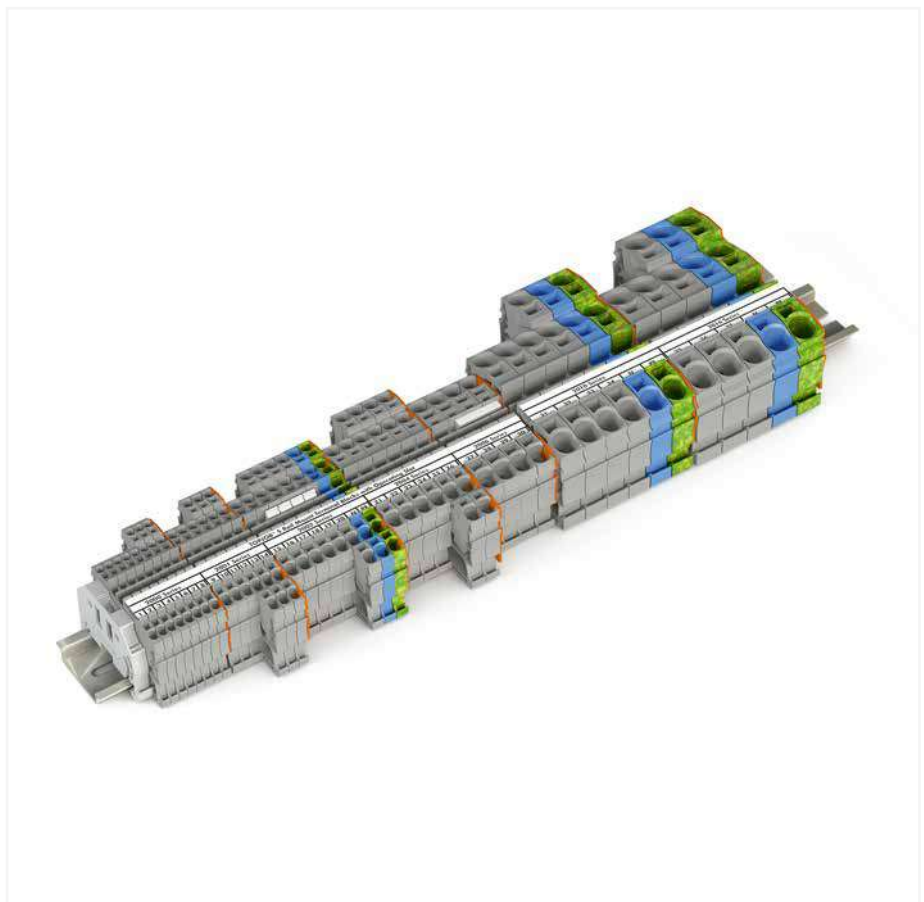

Push-in type jumper bar: Marking with a felt-tip pen.

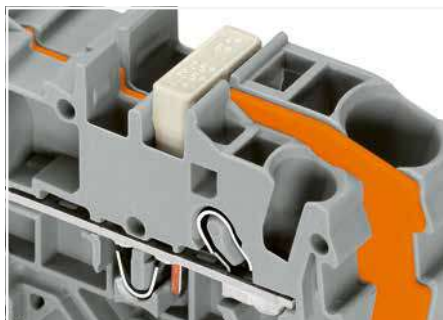

Commoning with step-down jumpers.



This star point jumper was specifically developed to create a "star point" and is used on motor terminal boards equipped with Rail-Mount Terminal Blocks TOPJOB® S.



Push-in CAGE CLAMP® terminates the following copper conductors: solid "s"



stranded "st"



fine-stranded "f-st", also with tinned single strands

PUSH-IN CAGE CLAMP®

1

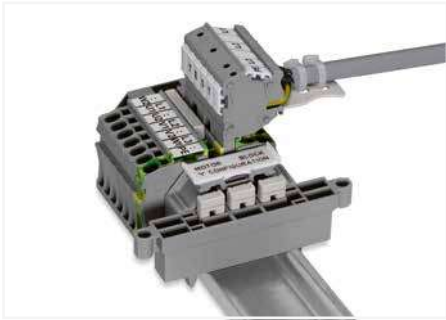

Rail-mount terminal block assembly for electric motor wiring



L-type test plug modules fitted in a triple-deck terminal block



Testing tap (2009-182) for tool-free connection of test cables up to 2.5 mm² (12 AWG) – compatible with 2000 to 2016 Series

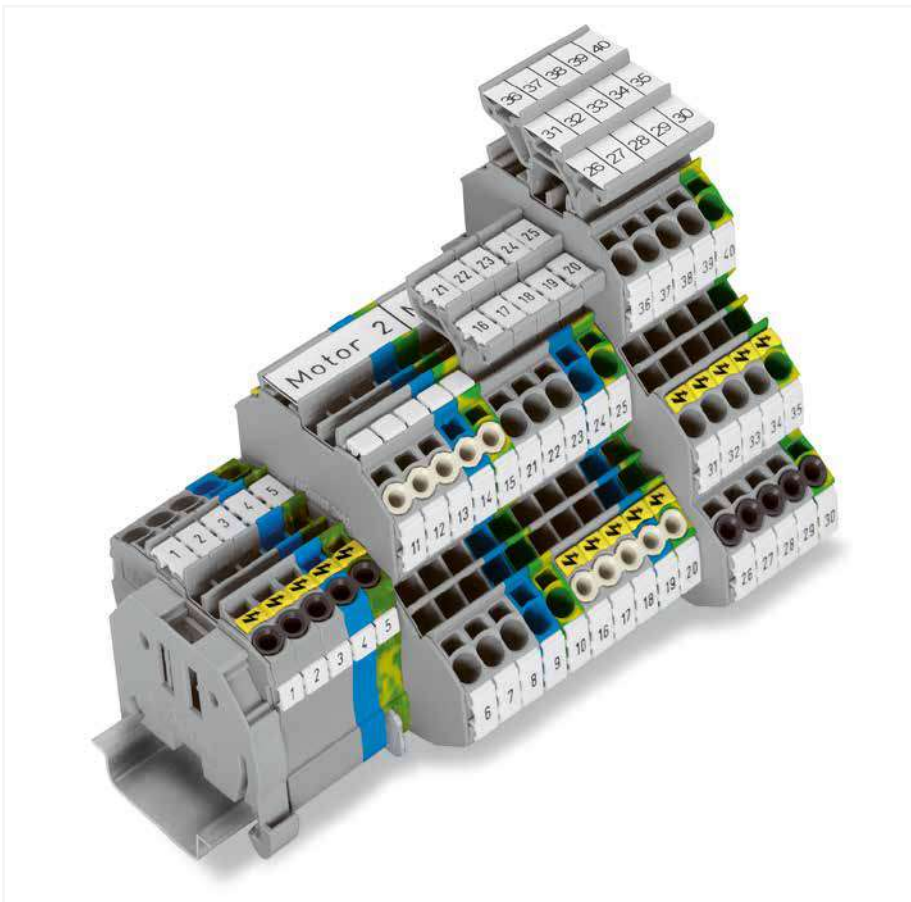

Test plug adapter (2009-174, CAT I) for 4 mm Ø plugs – compatible with 2000 to 2016 Series



Group marker carrier (2009-163) for marking strips (2009-110)

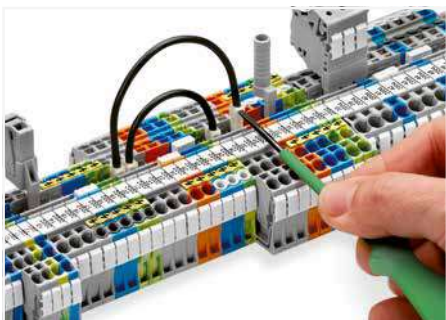

Push down the wire jumper until fully inserted. Lift the jumper with an operating tool for rewiring.

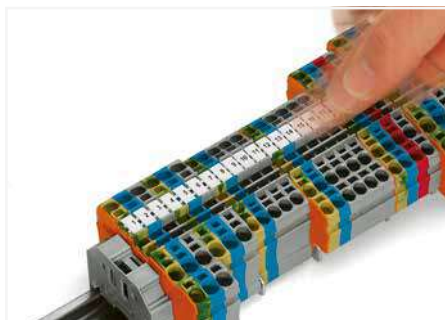

Snapping a marking strip into the marker slot.

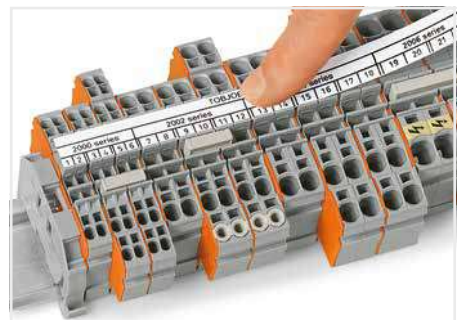

Snapping a marking strip into the marker slot.



fine-stranded, tip-bonded



fine-stranded, with ferrule (gastight crimped)



fine-stranded, with pin terminal (gastight crimped)

Through Terminal Block, Ground Conductor Terminal Block, Double-Potential Terminal Block TOPJOB® S 1 (1.5) mm²; 2000 Series

1

Technical Data	
0.14 ... 1 (1.5) mm ² ①	24 ... 16 AWG
800 V / 8 kV / 3 ②	600 V, 15 A ③
I _N 13.5 A (17.5 A)	600 V, 10 A ④
Terminal block width: 3.5 mm / 0.138 inch	
9 ... 11 mm / 0.35 ... 0.43 inch	

Technical Data	
0.14 ... 1 (1.5) mm ² ①	24 ... 16 AWG
800 V / 8 kV / 3 ②	600 V, 15 A ③
I _N 13.5 A (17.5 A)	600 V, 10 A ④
Terminal block width: 3.5 mm / 0.138 inch	
9 ... 11 mm / 0.35 ... 0.43 inch	

Technical Data	
0.14 ... 1 (1.5) mm ² ①	24 ... 16 AWG
800 V / 8 kV / 3 ②	600 V, 15 A ③
I _N 13.5 A (17.5 A)	600 V, 10 A ④
Terminal block width: 3.5 mm / 0.138 inch	
9 ... 11 mm / 0.35 ... 0.43 inch	

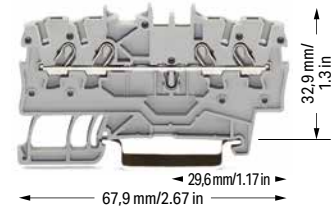
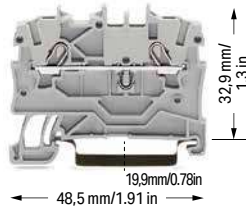

2-conductor through terminal block

Color	Item No.	Pack. Unit
gray ⑤	2000-1201 ④	100
blue ⑤	2000-1204 ③ ④	100
orange ⑤	2000-1202 ④	100
red ⑤	2000-1203 ④	100
black ⑤	2000-1205 ④	100
yellow ⑤	2000-1206 ④	100

3-conductor through terminal block

Color	Item No.	Pack. Unit
gray ⑤	2000-1301 ④	100
blue ⑤	2000-1304 ③ ④	100
orange ⑤	2000-1302 ④	100
red ⑤	2000-1303 ④	100
black ⑤	2000-1305 ④	100
yellow ⑤	2000-1306 ④	100

4-conductor through terminal block

Color	Item No.	Pack. Unit
gray ⑤	2000-1401 ④	100
blue ⑤	2000-1404 ③ ④	100
orange ⑤	2000-1402 ④	100
red ⑤	2000-1403 ④	100
black ⑤	2000-1405 ④	100
yellow ⑤	2000-1406 ④	100

2-conductor ground terminal block

green-yellow ⑤	2000-1207 ④	100
----------------	-------------	-----

3-conductor ground terminal block

green-yellow ⑤	2000-1307 ④	100
----------------	-------------	-----

4-conductor ground terminal block

green-yellow ⑤	2000-1407 ④	100
----------------	-------------	-----

Accessories; item-specific

End and intermediate plate; 0.7 mm thick

orange	2000-1292	100 (25)
gray	2000-1291	100 (25)

Accessories; item-specific

End and intermediate plate; 0.7 mm thick

orange	2000-1392	100 (25)
gray	2000-1391	100 (25)

Accessories; item-specific

End and intermediate plate; 0.7 mm thick

orange	2000-1492	100 (25)
gray	2000-1491	100 (25)

Ex e/Ex i separator; orange; 3 mm thick

90 mm	209-190	50 (25)
120 mm	209-191	50 (25)

Ex e/Ex i separator; orange; 3 mm thick

120 mm	209-191	50 (25)
--------	---------	---------

Ex e/Ex i separator; orange; 3 mm thick

120 mm	209-191	50 (25)
--------	---------	---------

Accessories; 2000 Series

Appropriate marking systems: WMB/WMB Inline/Marking strips

Push-in type jumper bar; insulated; I_N 13.5 A; light gray

2-way	2000-402	25
3-way	2000-403	25
4-way	2000-404	25
5-way	2000-405	25
6-way	2000-406	25
7-way	2000-407	25
8-way	2000-408	25
9-way	2000-409	25
10-way	2000-410	25

Delta jumper; insulated; I_N = I_N terminal block; light gray

1-2 3-4 5-6	2000-406/020-000	25
-------------	------------------	----

Spacer module; snaps together; bridges commoned terminal blocks

gray	2000-549	100 (25)
------	----------	----------

Star point jumper; insulated; I_N = I_N terminal block; light gray

1-3-5	2000-405/011-000	25
-------	------------------	----

Test plug adapter; for 4 mm Ø test plug

gray	2009-174	100 (25)
------	----------	----------

Push-in type jumper bar; insulated; I_N 13.5 A; light gray

1 to 3	2000-433	25
1 to 4	2000-434	25
1 to 5	2000-435	25
1 to 6	2000-436	25
1 to 7	2000-437	25
1 to 8	2000-438	25
1 to 9	2000-439	25
1 to 10	2000-440	25

Push-in type wire jumper; insulated; 0.75 mm² conductor cross-section; I_N 9 A

L = 60 mm	2009-402	100 (10)
L = 110 mm	2009-404	100 (10)
L = 250 mm	2009-406	100 (10)

Testing tap; for max. 2.5 mm²

gray	2009-182	100 (25)
------	----------	----------

Modular connector; snaps together; for jumper contact slot

Terminal block width: 5 mm / 0.197 inch

gray	2000-511	100 (25)
------	----------	----------

Protective warning marker; with black high-voltage symbol; for 5 terminal blocks

yellow	2000-115	100 (25)
--------	----------	----------

Modular connector; snaps together; for jumper contact slot

gray	2000-510	100 (25)
------	----------	----------

Technical Data

0.14 ... 1 (1.5) mm ² ①	24 ... 16 AWG
800 V / 8 kV / 3 ②	600 V, 15 A ③
I _N 13.5 A (17.5 A)	600 V, 10 A ④
Terminal block width: 3.5 mm / 0.138 inch	
9 ... 11 mm / 0.35 ... 0.43 inch	

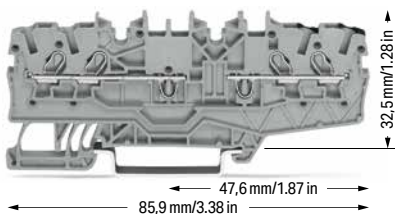

Double-potential terminal block; both potentials can be commoned

Color	Item No.	Pack. Unit
○ gray ⑤	2000-2141 ⑥	50

- ① Conductor range: 0.14 ... 1.5 mm² "s+f-st"; Push-in termination: 0.5 ... 1.5 mm² "s" and 0.5 ... 0.75 mm² "insulated ferrules; 10 mm" Depending on the conductor characteristic, a conductor with a smaller cross section can also be inserted via push-in termination.
- ② 800 V = rated voltage
8 kV = rated impulse voltage
3 = pollution degree (see Section 15)
- ③ Terminal blocks with a blue insulated housing are suitable for Ex i applications.
- ④ Terminal blocks with an Ex mark are suitable for Ex e II applications.
550 V; 13 A
12 A jumper (see Section 15)

Please observe the application notes:
Separator for Ex e/Ex i applications, see page 61
Jumpers, from page 182
Testing accessories, from page 176
Marking, from page 684

Approvals and corresponding ratings, visit www.wago.com

Accessories; item-specific

End and intermediate plate; 0.7 mm thick

	orange	2000-2196	100 (25)
	gray	2000-2195	100 (25)

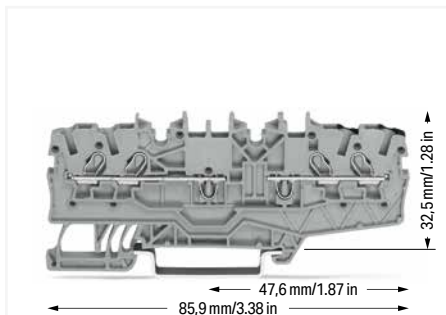

Front-entry double-potential terminal blocks are space savers. Two independent feedthrough circuits are placed in one insulated housing on one level in just 3.5 mm. This achieves a width of just 1.75 mm versus standard through terminal blocks. Input and output of a circuit are placed on the same side of the terminal block. Both circuits can be individually marked according to input and output.



Standard and quick marking options:
Three marker slots are available for both individual markers and marking strips.

Marking strip; plain; 11 mm wide; 50 m reel

	white	2009-110	1
---	-------	----------	---

WMB Inline; plain; 2,300 WMB markers (3.5 mm)/reel

	white	2009-113	1
---	-------	----------	---

WMB marking card; white; 10 strips with 10 markers/card; for 3.5 mm terminal block width

	plain	793-3501	5
---	-------	----------	---



2009-193 Group Marker Carrier (equipped with marking strips) for all 2001 to 2016 Series Rail-Mount Terminal Blocks TOPJOB® S
Do not use on an end plate!

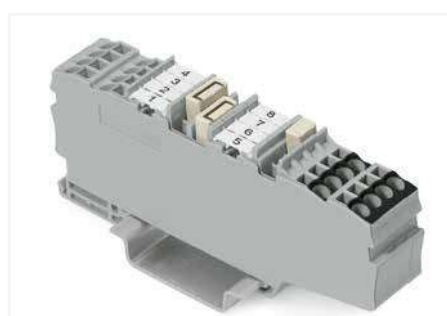

Standard and quick marking options:
Four marker slots (double-potential terminal blocks) are available for both individual markers and marking strips.

Through Terminal Block, Ground Conductor Terminal Block, Shield Conductor Terminal Block, Double-Potential Terminal Block TOPJOB® S

1.5 (2.5) mm²; 2001 Series

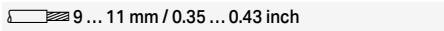
Technical Data	
0.25 ... 1.5 (2.5) mm ² ①	22 ... 14 AWG
800 V / 8 kV / 3 ②	600 V, 15 A ③
I _N 17.5 A (24 A)	600 V, 15 A ④
Terminal block width: 4.2 mm / 0.165 inch	
 9 ... 11 mm / 0.35 ... 0.43 inch	

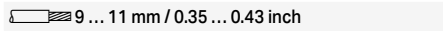
Technical Data	
0.25 ... 1.5 (2.5) mm ² ①	22 ... 14 AWG
800 V / 8 kV / 3 ②	600 V, 15 A ③
I _N 17.5 A (24 A)	600 V, 15 A ④
Terminal block width: 4.2 mm / 0.165 inch	
 9 ... 11 mm / 0.35 ... 0.43 inch	

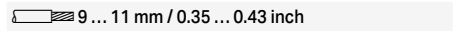
Technical Data	
0.25 ... 1.5 (2.5) mm ² ①	22 ... 14 AWG
800 V / 8 kV / 3 ②	600 V, 15 A ③
I _N 17.5 A (24 A)	600 V, 15 A ④
Terminal block width: 4.2 mm / 0.165 inch	
 9 ... 11 mm / 0.35 ... 0.43 inch	

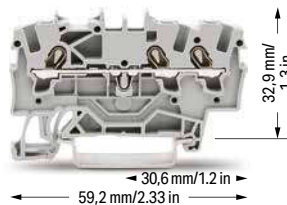
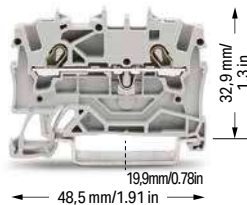

2-conductor through terminal block

Color	Item No.	Pack. Unit
gray ⑤	2001-1201 ④	100
blue ⑤	2001-1204 ③ ④	100
orange ⑤	2001-1202 ④	100
red ⑤	2001-1203 ④	100
black ⑤	2001-1205 ④	100
yellow ⑤	2001-1206 ④	100
dark gray-yellow ⑤	2001-1201/000-053 ④	100

3-conductor through terminal block

Color	Item No.	Pack. Unit
gray ⑤	2001-1301 ④	100
blue ⑤	2001-1304 ③ ④	100
orange ⑤	2001-1302 ④	100
red ⑤	2001-1303 ④	100
black ⑤	2001-1305 ④	100
yellow ⑤	2001-1306 ④	100
dark gray-yellow ⑤	2001-1301/000-053 ④	100

4-conductor through terminal block

Color	Item No.	Pack. Unit
gray ⑤	2001-1401 ④	100
blue ⑤	2001-1404 ③ ④	100
orange ⑤	2001-1402 ④	100
red ⑤	2001-1403 ④	100
black ⑤	2001-1405 ④	100
yellow ⑤	2001-1406 ④	100
dark gray-yellow ⑤	2001-1401/000-053 ④	100

2-conductor ground terminal block		
green-yellow ⑤	2001-1207 ④	100

3-conductor ground terminal block		
green-yellow ⑤	2001-1307 ④	100

4-conductor ground terminal block		
green-yellow ⑤	2001-1407 ④	100

2-conductor shield terminal block		
white	2001-1208	100



3-conductor shield terminal block		
white	2001-1308	100



4-conductor shield terminal block		
white	2001-1408	100



Other terminal blocks with the same profile:		
Diode	2001-1211/1000-411	Page 146



Other terminal blocks with the same profile:		
Diode	2001-1311/1000-411	Page 146
LED	2001-1321/1000-434	Page 146



Other terminal blocks with the same profile:		
Diode	2001-1411/1000-411	Page 146
LED	2001-1421/1000-434	Page 146



Accessories; item-specific			
End and intermediate plate; 0.8 mm thick			
	orange	2002-1292	100 (25)
	gray	2002-1291	100 (25)



Accessories; item-specific			
End and intermediate plate; 0.8 mm thick			
	orange	2002-1392	100 (25)
	gray	2002-1391	100 (25)

Accessories; item-specific			
End and intermediate plate; 0.8 mm thick			
	orange	2002-1492	100 (25)
	gray	2002-1491	100 (25)

Separator; oversized; 2 mm thick			
	orange	2002-1294	100 (25)
	gray	2002-1293	100 (25)

Separator; oversized; 2 mm thick			
	orange	2002-1394	100 (25)
	gray	2002-1393	100 (25)

Separator; oversized; 2 mm thick			
	orange	2002-1494	100 (25)
	gray	2002-1493	100 (25)

Ex e/Ex i separator; orange; 3 mm thick			
	90 mm	209-190	50 (25)
	120 mm	209-191	50 (25)

Ex e/Ex i separator; orange; 3 mm thick			
	120 mm	209-191	50 (25)

Ex e/Ex i separator; orange; 3 mm thick			
	120 mm	209-191	50 (25)

Accessories; 2001 Series

Appropriate marking systems: WMB/WMB Inline/Marking strips

Insulation stop; 5 pcs/strip; 0.25 ... 0.5 mm ²			
	light gray	2001-171	200 (25)

Push-in type jumper bar; insulated; I _N 17.5 A; light gray			
	2-way	2001-402	25
	3-way	2001-403	25
	4-way	2001-404	25
	5-way	2001-405	25
	6-way	2001-406	25
	7-way	2001-407	25
	8-way	2001-408	25
	9-way	2001-409	25
	10-way	2001-410	25

Push-in type jumper bar; insulated; I _N 17.5 A; light gray			
	1 to 3	2001-433	25
	1 to 4	2001-434	25
	1 to 5	2001-435	25
	1 to 6	2001-436	25
	1 to 7	2001-437	25
	1 to 8	2001-438	25
	1 to 9	2001-439	25
	1 to 10	2001-440	25

Protective warning marker; with black high-voltage symbol; for 5 terminal blocks			
	yellow	2001-115	100 (25)

Technical Data

0.25 ... 1.5 (2.5) mm² ① | 22 ... 14 AWG

800 V / 8 kV / 3 ② | 600 V, 15 A ③

I_N 17.5 A (24 A) | 600 V, 15 A ④

Terminal block width: 4.2 mm / 0.165 inch

9 ... 11 mm / 0.35 ... 0.43 inch

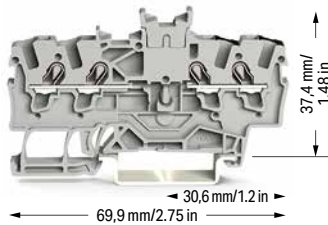

Double-potential terminal block; with push-button; with double, center marking slot

Notice: This double potential terminal block cannot be commoned with push-in type jumper bars!

Color	Item No.	Pack. Unit
○ gray ⑤	2001-1441 ⑥	100

① Conductor range: 0.25 ... 2.5 mm² "s+f-st"; Push-in termination: 0.75 ... 2.5 mm² "s" and 0.75 ... 1.5 mm² "insulated ferrules; 12 mm" Depending on the conductor characteristic, a conductor with a smaller cross section can also be inserted via push-in termination.

② 800 V = rated voltage
8 kV = rated impulse voltage
3 = pollution degree (see Section 15)

③ Terminal blocks with a blue insulated housing are suitable for Ex i applications.

④ Terminal blocks with an Ex mark are suitable for Ex e II applications.
550 V; 17 A
16 A jumper
Double-potential terminal block 550 V; 15 A (see Section 15)

Please observe the application notes:
Separator for Ex e/Ex i applications, see page 61
Step-down jumpers, see page 65
Jumpers, from page 185
Testing accessories, from page 176
Marking, from page 684

Approvals and corresponding ratings, visit www.wago.com

Accessories; 2001 Series

Appropriate marking systems:
WMB/WMB Inline/Marking strips

Step-down jumper; insulated; commons 6/4 mm² (10/12 AWG) to 4/2.5/1.5 mm² (12/14/16 AWG); I_N 32 A



light gray 2006-499 25

Push-in type wire jumper; insulated; 1.5 mm² conductor cross-section; I_N 18 A



L = 60 mm 2009-412 100 (10)

L = 110 mm 2009-414 100 (10)

L = 250 mm 2009-416 100 (10)

Modular connector; snaps together; for jumper contact slot



gray 2001-511 100 (25)

Accessories; item-specific

End and intermediate plate; 0.9 mm thick

orange	2002-1492	100 (25)
gray	2002-1491	100 (25)

Separator; oversized; 2 mm thick

orange	2002-1494	100 (25)
gray	2002-1493	100 (25)

Delta jumper; insulated; I_N = I_N terminal block; light gray

1-2-3-4-5-6 2001-406/020-000 25

Star point jumper; insulated; I_N = I_N terminal block; light gray

1-3-5 2001-405/011-000 25

Spacer module; snaps together; bridges commoned terminal blocks



gray 2001-549 100 (25)

Test plug adapter; for 4 mm Ø test plug



gray 2009-174 100 (25)

Testing tap; for max. 2.5 mm²

gray 2009-182 100 (25)

Marking strip; plain; 11 mm wide; 50 m reel



white 2009-110 1

WMB Inline; plain; 2,000 WMB markers (4 mm)/reel; 4 ... 4.2 mm stretchable



white 2009-114 1

WMB marking card; white; 10 strips with 10 markers/card; 4 ... 4.2 mm stretchable



plain 793-4501 5



Notice: These double-potential terminal blocks cannot be commoned with push-in type jumper bars! Front-entry double-potential terminal blocks are space savers. Two independent feedthrough circuits are placed in one insulated housing on one level in just 4.2 mm. This achieves a width of just 2.1 mm versus standard through terminal blocks. Input and output of a circuit are placed on the same side of the terminal block. Both circuits can be individually marked according to input and output.

Through Terminal Block, Ground Conductor Terminal Block, Shield Conductor Terminal Block, Double-Potential Terminal Block TOPJOB® S

2.5 (4) mm²; 2002 Series

1

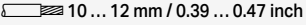
Technical Data	
0.25 ... 2.5 (4) mm ² ①	22 ... 12 AWG
800 V / 8 kV / 3 ②	600 V, 20 A ③
I _N 24 A (32 A)	600 V, 20 A ④
Terminal block width: 5.2 mm / 0.205 inch	
 10 ... 12 mm / 0.39 ... 0.47 inch	

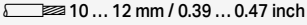
Technical Data	
0.25 ... 2.5 (4) mm ² ①	22 ... 12 AWG
800 V / 8 kV / 3 ②	600 V, 20 A ③
I _N 24 A (32 A)	600 V, 20 A ④
Terminal block width: 5.2 mm / 0.205 inch	
 10 ... 12 mm / 0.39 ... 0.47 inch	

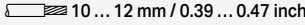
Technical Data	
0.25 ... 2.5 (4) mm ² ①	22 ... 12 AWG
800 V / 8 kV / 3 ②	600 V, 20 A ③
I _N 24 A (32 A)	600 V, 20 A ④
Terminal block width: 5.2 mm / 0.205 inch	
 10 ... 12 mm / 0.39 ... 0.47 inch	

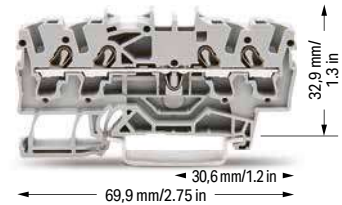
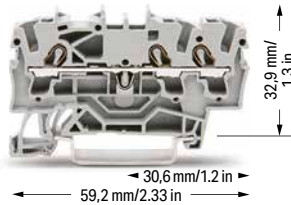

2-conductor through terminal block

Color	Item No.	Pack. Unit
gray ⑤	2002-1201 ④	100
blue ⑤	2002-1204 ③ ④	100
orange ⑤	2002-1202 ④	100
red ⑤	2002-1203 ④	100
black ⑤	2002-1205 ④	100
yellow ⑤	2002-1206 ④	100

3-conductor through terminal block

Color	Item No.	Pack. Unit
gray ⑤	2002-1301 ④	100
blue ⑤	2002-1304 ③ ④	100
orange ⑤	2002-1302 ④	100
red ⑤	2002-1303 ④	100
black ⑤	2002-1305 ④	100
yellow ⑤	2002-1306 ④	100

4-conductor through terminal block

Color	Item No.	Pack. Unit
gray ⑤	2002-1401 ④	100
blue ⑤	2002-1404 ③ ④	100
orange ⑤	2002-1402 ④	100
red ⑤	2002-1403 ④	100
black ⑤	2002-1405 ④	100
yellow ⑤	2002-1406 ④	100
brown ⑤	2002-1401/000-014 ④	100

2-conductor ground terminal block		
green-yellow ⑤	2002-1207 ④	100

3-conductor ground terminal block		
green-yellow ⑤	2002-1307 ④	100

4-conductor ground terminal block		
green-yellow ⑤	2002-1407 ④	100

2-conductor shield terminal block		
white	2002-1208	100

3-conductor shield terminal block		
white	2002-1308	100



4-conductor shield terminal block		
white	2002-1408	100

Other terminal blocks with the same profile:		
Diode	2002-1211/1000-411	Page 156



Other terminal blocks with the same profile:		
Diode	2002-1311/1000-411	Page 156
LED	2002-1321/1000-434	Page 156

Other terminal blocks with the same profile:		
Diode	2002-1411/1000-411	Page 156
LED	2002-1421/1000-434	Page 156

Accessories; item-specific

End and intermediate plate; 0.8 mm thick			
	orange	2002-1292	100 (25)
	gray	2002-1291	100 (25)

Accessories; item-specific

End and intermediate plate; 0.8 mm thick			
	orange	2002-1392	100 (25)
	gray	2002-1391	100 (25)

Accessories; item-specific

End and intermediate plate; 0.8 mm thick			
	orange	2002-1492	100 (25)
	gray	2002-1491	100 (25)

Separator; oversized; 2 mm thick

	orange	2002-1294	100 (25)
	gray	2002-1293	100 (25)

Separator; oversized; 2 mm thick

	orange	2002-1394	100 (25)
	gray	2002-1393	100 (25)

Separator; oversized; 2 mm thick

	orange	2002-1494	100 (25)
	gray	2002-1493	100 (25)

Ex e/Ex i separator; orange; 3 mm thick

	90 mm	209-190	50 (25)
	120 mm	209-191	50 (25)

Ex e/Ex i separator; orange; 3 mm thick

	120 mm	209-191	50 (25)
---	--------	---------	---------

Ex e/Ex i separator; orange; 3 mm thick

	120 mm	209-191	50 (25)
---	--------	---------	---------

Accessories; 2002 Series

Appropriate marking systems: WMB/WMB Inline/Marking strips

Insulation stop; 5 pcs/strip; 0.25 ... 0.5 mm²

	light gray	2002-171	200 (25)
---	------------	----------	----------

Push-in type jumper bar; insulated; I_N 25 A; light gray

	2-way	2002-402	25
	3-way	2002-403	25
	4-way	2002-404	25
	5-way	2002-405	25
	6-way	2002-406	25
	7-way	2002-407	25
	8-way	2002-408	25
	9-way	2002-409	25
	10-way	2002-410	25

Push-in type jumper bar; insulated; I_N 25 A; light gray

	1 to 3	2002-433	25
	1 to 4	2002-434	25
	1 to 5	2002-435	25
	1 to 6	2002-436	25
	1 to 7	2002-437	25
	1 to 8	2002-438	25
	1 to 9	2002-439	25
	1 to 10	2002-440	25

PUSH-IN CAGE CLAMP®

1

Technical Data

0.25 ... 2.5 (4) mm ² ①	22 ... 12 AWG
800 V / 8 kV / 3 ②	600 V, 20 A ③
I _N 24 A (32 A)	600 V, 20 A ④

Terminal block width: 5.2 mm / 0.205 inch

10 ... 12 mm / 0.39 ... 0.47 inch

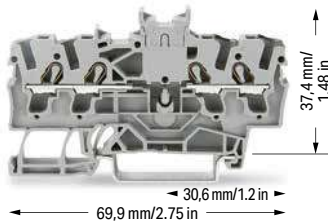

Double-potential terminal block; with double, center marking slot
 Notice: This double potential terminal block cannot be commoned with push-in type jumper bars!

Color	Item No.	Pack. Unit
gray ⑤	2002-1441 ⑥	100

① Conductor range: 0.25 ... 4 mm² "s+f-st";
 Push-in termination: 1 ... 4 mm² "s" and 1 ... 2.5 mm² "insulated ferrules, 12 mm"
 Depending on the conductor characteristic, a conductor with a smaller cross section can also be inserted via push-in termination.

② 800 V = rated voltage
 8 kV = rated impulse voltage
 3 = pollution degree (see Section 15)

③ Terminal blocks with a blue insulated housing are suitable for Ex i applications.

④ Terminal blocks with an Ex mark are suitable for Ex e II applications.
 550 V; 22 A
 Double-potential terminal block 550 V; 21 A
 20 A jumper (see Section 15)

Please observe the application notes:
 Separator for Ex e/Ex i applications, see page 61
 Step-down jumpers, see page 65
 Jumpers, from page 182
 Testing accessories, from page 177
 Marking, from page 684

Approvals and corresponding ratings, visit www.wago.com

Accessories; 2002 Series

Appropriate marking systems:
 WMB/WMB Inline/Marking strips

Continuous jumper; insulated; I_N 25 A, light gray

2-way	2002-400	25
-------	----------	----



Continuous jumper; insulated; I_N 25 A; light gray

1 to 3	2002-423	25
1 to 4	2002-424	25



Continuous jumper; insulated; I_N 25 A, light gray

3-way	2002-413	25
5-way	2002-415	25



Step-down jumper; insulated; commons 6/4 mm² (10/12 AWG) to 4/2.5/1.5 mm² (12/14/16 AWG); I_N 32 A

light gray	2006-499	25
------------	----------	----



Staggered jumper; insulated; I_N 25 A; light gray

2-way	2002-472	25
3-way	2002-473	25
4-way	2002-474	25
5-way	2002-475	25
6-way	2002-476	25
7-way	2002-477	25
8-way	2002-478	25
9-way	2002-479	25
10-way	2002-480	25
11-way	2002-481	25
12-way	2002-482	25



Customized staggered jumper; insulated; with contact lugs broken off at the factory and circuit printing; I_N 25 A; light gray

1-3	2002-473/011-000	25
1-3-5	2002-475/011-000	25
1-3-5-7	2002-477/011-000	25
1-3-5-7-9	2002-479/011-000	25
1-3-5-7-9-11	2002-481/011-000	25



Accessories; 2002 Series

Appropriate marking systems:
 WMB/WMB Inline/Marking strips

Push-in type wire jumper; insulated; 1.5 mm² conductor cross-section; I_N 18 A

L = 60 mm	2009-412	100 (10)
L = 110 mm	2009-414	100 (10)
L = 250 mm	2009-416	100 (10)



Protective warning marker; with black high-voltage symbol; for 5 terminal blocks

yellow	2002-115	100 (25)
--------	----------	----------



Modular connector; snaps together; for jumper contact slot

gray	2002-511	100 (25)
------	----------	----------



L-type test plug module; snaps together

gray	2002-611	100 (25)
------	----------	----------



L-type spacer module; snaps together; bridges commoned terminal blocks

gray	2002-649	100 (25)
------	----------	----------



Test plug adapter; for 4 mm Ø test plug

gray	2009-174	100 (25)
------	----------	----------



Testing tap; for max. 2.5 mm²

gray	2009-182	100 (25)
------	----------	----------



Marking strip; plain; 11 mm wide; 50 m reel

white	2009-110	1
-------	----------	---

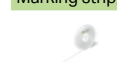

WMB marking card; white; 10 strips with 10 markers/card; 5 ... 5.2 mm stretchable

plain	793-5501	5
-------	----------	---



Accessories; item-specific

End and intermediate plate; 0.9 mm thick

orange	2002-1492	100 (25)
gray	2002-1491	100 (25)



Separator; oversized; 2 mm thick

orange	2002-1494	100 (25)
gray	2002-1493	100 (25)



Delta jumper; insulated; I_N = I_N terminal block; light gray

1-2 3-4 5-6	2002-406/020-000	25
-------------	------------------	----



Star point jumper; insulated; I_N = I_N terminal block; light gray

1-3-5	2002-405/011-000	25
-------	------------------	----

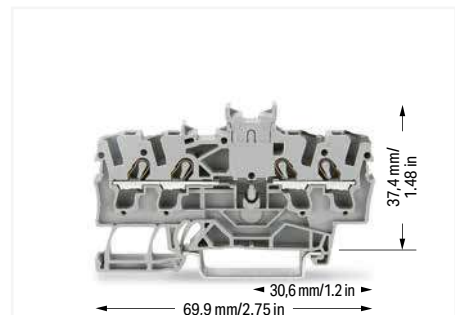

Notice: These double-potential terminal blocks cannot be commoned with push-in type jumper bars! Front-entry double-potential terminal blocks are space savers. Two independent feedthrough circuits are placed in one insulated housing on one level in just 5.2 mm. This achieves a width of just 2.6 mm versus standard through terminal blocks. Input and output of a circuit are placed on the same side of the terminal block. Both circuits can be individually marked according to input and output.

PUSH-IN CAGE CLAMP®

Through Terminal Block, Ground Conductor Terminal Block, Shield Conductor Terminal Block, TOPJOB® S

2.5 (4) mm²; 2002 Series

1

Technical Data

0.25 ... 2.5 (4) mm ² ①	22 ... 12 AWG
800 V / 8 kV / 3 ②	600 V, 20 A ③
I _N 24 A (32 A)	600 V, 20 A ④
Terminal block width: 5.2 mm / 0.205 inch	
 10 ... 12 mm / 0.39 ... 0.47 inch	

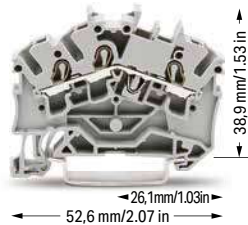

3-conductor through terminal block

Color	Item No.	Pack. Unit
gray ⑤	2002-6301 ④	100
blue ⑤	2002-6304 ③ ④	100
orange ⑤	2002-6302 ④	100
red ⑤	2002-6303 ④	100
black ⑤	2002-6305 ④	100
yellow ⑤	2002-6306 ④	100

3-conductor ground terminal block

green-yellow ⑤	2002-6307 ④	100
----------------	-------------	-----

3-conductor shield terminal block

white	2002-6308	100
-------	-----------	-----

Accessories; 2002 Series

Appropriate marking systems:
WMB/WMB Inline/Marking strips

End and intermediate plate; 0.8 mm thick

orange	2002-6392	100 (25)
gray	2002-6391	100 (25)

Ex e/Ex i separator; orange; 3 mm thick

120 mm	209-191	50 (25)
--------	---------	---------

Insulation stop; 5 pcs/strip; 0.25 ... 0.5 mm²

light gray	2002-171	200 (25)
------------	----------	----------

Insulation stop; 5 pcs/strip; 0.75 ... 1 mm²

dark gray	2002-172	200 (25)
-----------	----------	----------

Protective warning marker; with black high-voltage symbol; for 5 terminal blocks

yellow	2002-115	100 (25)
--------	----------	----------

Push-in type jumper bar; insulated; I_N 25 A; light gray

2-way	2002-402	25
3-way	2002-403	25
4-way	2002-404	25
5-way	2002-405	25
6-way	2002-406	25
7-way	2002-407	25
8-way	2002-408	25
9-way	2002-409	25
10-way	2002-410	25

① Conductor range: 0.25 ... 4 mm² "s+f-st";
Push-in termination: 1 ... 4 mm² "s" and 1 ... 2.5 mm² "insulated ferrules, 12 mm"
Depending on the conductor characteristic, a conductor with a smaller cross section can also be inserted via push-in termination.

② 800 V = rated voltage
8 kV = rated impulse voltage
3 = pollution degree
(see Section 15)

③ Terminal blocks with a blue insulated housing are suitable for Ex i applications.

④ Terminal blocks with an Ex mark are suitable for Ex e II applications.
550 V; 22 A
20 A jumper
(see Section 15)

Please observe the application notes:
Separator for Ex e/Ex i applications, see page 61
Jumpers, from page 182
Testing accessories, from page 177
Marking, from page 684

Approvals and corresponding ratings, visit www.wago.com

Accessories; 2002 Series

Appropriate marking systems:
WMB/WMB Inline/Marking strips

Push-in type jumper bar; insulated; I_N 25 A; light gray

1 to 3	2002-433	25
1 to 4	2002-434	25
1 to 5	2002-435	25
1 to 6	2002-436	25
1 to 7	2002-437	25
1 to 8	2002-438	25
1 to 9	2002-439	25
1 to 10	2002-440	25

Delta jumper; insulated; I_N = I_N terminal block; light gray

1-2 3-4 5-6	2002-406/020-000	25
-------------	------------------	----

Star point jumper; insulated; I_N = I_N terminal block; light gray

1-3-5	2002-405/011-000	25
-------	------------------	----

Staggered jumper; insulated; I_N 25 A; light gray

2-way	2002-472	25
3-way	2002-473	25
4-way	2002-474	25
5-way	2002-475	25
6-way	2002-476	25
7-way	2002-477	25
8-way	2002-478	25
9-way	2002-479	25
10-way	2002-480	25
11-way	2002-481	25
12-way	2002-482	25

Customized staggered jumper; insulated; with contact lugs broken off at the factory and circuit printing; I_N 25 A; light gray

1-3	2002-473/011-000	25
1-3-5	2002-475/011-000	25
1-3-5-7	2002-477/011-000	25
1-3-5-7-9	2002-479/011-000	25
1-3-5-7-9-11	2002-481/011-000	25

Continuous jumper; insulated; I_N 25 A, light gray

2-way	2002-400	25
-------	----------	----

Accessories; 2002 Series

Appropriate marking systems:
WMB/WMB Inline/Marking strips

Continuous jumper; insulated; I_N 25 A; 1 to 3

light gray	2002-423	25
red	2002-423/000-005	25
blue	2002-423/000-006	25

Push-in type wire jumper; insulated; 1.5 mm² conductor cross-section; I_N 18 A

L = 60 mm	2009-412	100 (10)
L = 110 mm	2009-414	100 (10)
L = 250 mm	2009-416	100 (10)

Modular connector; snaps together; for jumper contact slot

gray	2002-511	100 (25)
------	----------	----------

Spacer module; snaps together; bridges commoned terminal blocks

gray	2002-549	100 (25)
------	----------	----------

L-type test plug module; snaps together

gray	2002-611	100 (25)
------	----------	----------

L-type spacer module; snaps together; bridges commoned terminal blocks

gray	2002-649	100 (25)
------	----------	----------

Test plug adapter; for 4 mm Ø test plug

gray	2009-174	100 (25)
------	----------	----------

Testing tap; for max. 2.5 mm²

gray	2009-182	100 (25)
------	----------	----------

Marking strip; plain; 11 mm wide; 50 m reel

white	2009-110	1
-------	----------	---

WMB Inline, plain; 1,500 WMB markers (5 mm)/reel; 5 ... 5.2 mm stretchable

white	2009-115	1
-------	----------	---

WMB marking card; white; 10 strips with 10 markers/card; 5 ... 5.2 mm stretchable

plain	793-5501	5
-------	----------	---

Through Terminal Block, Ground Conductor Terminal Block TOPJOB® S 2.5 (4) mm²; 2002 Series

Technical Data

0.25 ... 2.5 (4) mm ² ①	22 ... 12 AWG
800 V / 8 kV / 3 ①	600 V, 20 A ②
I _N 24 A (32 A)	600 V, 20 A ③
Terminal block width: 5.2 mm / 0.205 inch	
10 ... 12 mm / 0.39 ... 0.47 inch	



4-conductor through terminal block

Notice: This terminal block cannot be commoned with push-in type jumper bars!

Color	Item No.	Pack. Unit
gray ④	2002-6401 ④	100
blue ④	2002-6404 ④ ④	100
orange ④	2002-6402 ④	100
red ④	2002-6403 ④	100
black ④	2002-6405 ④	100
yellow ④	2002-6406 ④	100

4-conductor ground terminal block

green-yellow ④	2002-6407 ④	100
----------------	-------------	-----

Accessories; 2002 Series

Appropriate marking systems:
WMB/WMB Inline/Marking strips

End and intermediate plate; 0.8 mm thick

orange	2002-6392	100 (25)
gray	2002-6391	100 (25)

Ex e/Ex i separator; orange; 3 mm thick

120 mm	209-191	50 (25)
--------	---------	---------

Insulation stop; 5 pcs/strip; 0.25 ... 0.5 mm²

light gray	2002-171	200 (25)
------------	----------	----------

Insulation stop; 5 pcs/strip; 0.75 ... 1 mm²

dark gray	2002-172	200 (25)
-----------	----------	----------

Protective warning marker; with black high-voltage symbol; for 5 terminal blocks

yellow	2002-115	100 (25)
--------	----------	----------

Marking strip; plain; 11 mm wide; 50 m reel

white	2009-110	1
-------	----------	---

WMB Inline, plain; 1,500 WMB markers (5 mm)/reel; 5 ... 5.2 mm stretchable

white	2009-115	1
-------	----------	---

- Conductor range: 0.25 ... 4 mm² "s+f-st";
Push-in termination: 1 ... 4 mm² "s" and 1 ... 2.5 mm² "insulated ferrules, 12 mm"
Depending on the conductor characteristic, a conductor with a smaller cross section can also be inserted via push-in termination.
- 800 V = rated voltage
8 kV = rated impulse voltage
3 = pollution degree
(see Section 15)
- Terminal blocks with a blue insulated housing are suitable for Ex applications.
- Terminal blocks with an Ex mark are suitable for Ex e II applications.
550 V; 22 A
20 A jumper
(see Section 15)

Please observe the application notes:
Separator for Ex e/Ex i applications, see page 61
Marking, from page 684

Approvals and corresponding ratings,
visit www.wago.com

Accessories; 2002 Series

Appropriate marking systems:
WMB/WMB Inline/Marking strips

WMB marking card; white; 10 strips with 10 markers/card;
5 ... 5.2 mm stretchable

plain	793-5501	5
-------	----------	---

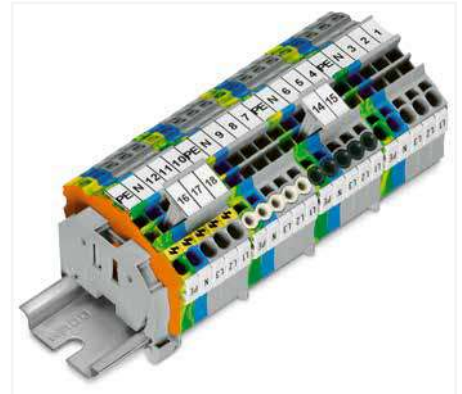

3- and 4-conductor terminal blocks (angled type):

WAGO's Rail-Mount Terminal Blocks TOPJOB® S have a 35-degree conductor entry angle permitting a very small bend radius and an extremely short wiring distance to the cable duct. These are space- and cost-saving solutions for switchgear and control cabinet applications that use the LSC wiring system from Lütze. The design allows cable duct to be placed very close to the terminal blocks, keeping its height relatively low.

Product features:

- Push-in CAGE CLAMP® connection for all conductor types, with the additional benefit of solid, stranded and fine-stranded conductors with ferrules being simply pushed in
- Vibration-proof, fast, maintenance-free
- 3-conductor through and ground conductor terminal blocks equipped with a dual jumper slot
- 4-conductor terminal blocks permit potential multiplication – no additional jumpers or terminal blocks needed
- 3- and 4-conductor terminal blocks have the same dimensions.
- An end plate must be applied when changing from a 3-conductor terminal block to a 4-conductor terminal block and vice versa.

Through Terminal Block, Ground Conductor Terminal Block, Shield Conductor Terminal Block TOPJOB® S 4 (6) mm²; 2004 Series

1

Technical Data	
0.5 ... 4 (6) mm ² ①	20 ... 10 AWG
800 V / 8 kV / 3 ②	600 V, 30 A ③
I _N 32 A (41 A)	600 V, 30 A ④
Terminal block width: 6.2 mm / 0.244 inch	
 11 ... 13 mm / 0.43 ... 0.51 inch	

Technical Data	
0.5 ... 4 (6) mm ² ①	20 ... 10 AWG
800 V / 8 kV / 3 ②	600 V, 30 A ③
I _N 32 A (41 A)	600 V, 30 A ④
Terminal block width: 6.2 mm / 0.244 inch	
 11 ... 13 mm / 0.43 ... 0.51 inch	

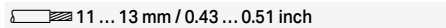
Technical Data	
0.5 ... 4 (6) mm ² ①	20 ... 10 AWG
800 V / 8 kV / 3 ②	600 V, 30 A ③
I _N 32 A (41 A)	600 V, 30 A ④
Terminal block width: 6.2 mm / 0.244 inch	
 11 ... 13 mm / 0.43 ... 0.51 inch	

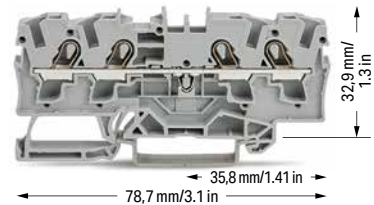

2-conductor through terminal block		
Color	Item No.	Pack. Unit
gray ⑤	2004-1201 ④	50
blue ⑤	2004-1204 ③ ④	50
orange ⑤	2004-1202 ④	50
red ⑤	2004-1203 ④	50
black ⑤	2004-1205 ④	50
yellow ⑤	2004-1206 ④	50

3-conductor through terminal block		
Color	Item No.	Pack. Unit
gray ⑤	2004-1301 ④	50
blue ⑤	2004-1304 ③ ④	50
orange ⑤	2004-1302 ④	50
red ⑤	2004-1303 ④	50
black ⑤	2004-1305 ④	50
yellow ⑤	2004-1306 ④	50

4-conductor through terminal block		
Color	Item No.	Pack. Unit
gray ⑤	2004-1401 ④	50
blue ⑤	2004-1404 ③ ④	50
orange ⑤	2004-1402 ④	50
red ⑤	2004-1403 ④	50
black ⑤	2004-1405 ④	50
yellow ⑤	2004-1406 ④	50

2-conductor ground terminal block		
green-yellow ⑤	2004-1207 ④	50

3-conductor ground terminal block		
green-yellow ⑤	2004-1307 ④	50



4-conductor ground terminal block		
green-yellow ⑤	2004-1407 ④	50



4-conductor shield terminal block		
white ⑤	2004-1408	50



Other terminal blocks with the same profile:		
Diode	2004-1211/1000-401	Page 158



Other terminal blocks with the same profile:		
Diode	2004-1311/1000-401	Page 158



Other terminal blocks with the same profile:		
Diode	2004-1411/1000-401	Page 158



Accessories; item-specific			
End and intermediate plate; 1 mm thick			
	orange	2004-1292	100 (25)
	gray	2004-1291	100 (25)



Accessories; item-specific			
End and intermediate plate; 1 mm thick			
	orange	2004-1392	100 (25)
	gray	2004-1391	100 (25)

Accessories; item-specific			
End and intermediate plate; 1 mm thick			
	orange	2004-1492	100 (25)
	gray	2004-1491	100 (25)

Separator; oversized; 2 mm thick			
	orange	2004-1294	100 (25)
	gray	2004-1293	100 (25)

Separator; oversized; 2 mm thick			
	orange	2004-1394	100 (25)
	gray	2004-1393	100 (25)

Separator; oversized; 2 mm thick			
	orange	2004-1494	100 (25)
	gray	2004-1493	100 (25)

Ex e/Ex i separator; orange; 3 mm thick			
	90 mm	209-190	50 (25)
	120 mm	209-191	50 (25)









Ex e/Ex i separator; orange; 3 mm thick			
	120 mm	209-191	50 (25)









Ex e/Ex i separator; orange; 3 mm thick			
	120 mm	209-191	50 (25)

Accessories; 2004 Series

Appropriate marking systems: WMB/WMB Inline/Marking strips

Insulation stop; 5 pcs/strip; 0.25 ... 0.5 mm ²			
	light gray	2004-171	200 (25)

Push-in type jumper bar; insulated; I _N 32 A; light gray			
	2-way	2004-402	25
	3-way	2004-403	25
	4-way	2004-404	25
	5-way	2004-405	25
	6-way	2004-406	25
	7-way	2004-407	25
	8-way	2004-408	25
	9-way	2004-409	25
	10-way	2004-410	25

Push-in type jumper bar; insulated; I _N 32 A; light gray			
	1 to 3	2004-433	25
	1 to 4	2004-434	25
	1 to 5	2004-435	25
	1 to 6	2004-436	25
	1 to 7	2004-437	25
	1 to 8	2004-438	25
	1 to 9	2004-439	25
	1 to 10	2004-440	25

Insulation stop; 5 pcs/strip; 0.75 ... 1 mm ²			
	dark gray	2004-172	200 (25)

Step-down jumper; insulated; commons 6/4 mm ² (10/12 AWG) to 4/2.5/1.5 mm ² (12/14/16 AWG); I _N 32 A			
	light gray	2006-499	25

Protective warning marker; with black high-voltage symbol; for 5 terminal blocks			
	yellow	2004-115	100 (25)

Star point jumper; insulated; I _N = I _N terminal block; light gray			
	1-3-5	2004-405/011-000	25

Delta jumper; insulated; I _N = I _N terminal block; light gray			
	1-2 3-4 5-6	2004-406/020-000	25

- ❶ Conductor range: 0.5 ... 6 mm² "s+f-st";
Push-in termination: 1.5 ... 6 mm² "s" and 1.5 ... 4 mm² "insulated ferrules; 12 mm"
Depending on the conductor characteristic, a conductor with a smaller cross section can also be inserted via push-in termination.
- ❷ 800 V = rated voltage
8 kV = rated impulse voltage
3 = pollution degree
(see Section 15)
- ❸ Terminal blocks with a blue insulated housing are suitable for Ex i applications.
- ❹ Terminal blocks with an Ex mark are suitable for Ex e II applications.
550 V; 30 A
(see Section 15)

Please observe the application notes:
Separator for Ex e/Ex i applications, see page 61
Step-down jumpers, see page 65
Jumpers, from page 185
Testing accessories, from page 178
Marking, from page 684

Approvals and corresponding ratings, visit www.wago.com

Accessories; 2004 Series

Appropriate marking systems:
WMB/WMB Inline/Marking strips

Modular connector; snaps together; for jumper contact slot

	gray	2004-511	100 (25)
---	------	----------	----------

Spacer module; snaps together; bridges commoned terminal blocks

	gray	2004-549	100 (25)
---	------	----------	----------

Test plug adapter; for 4 mm Ø test plug

	gray	2009-174	100 (25)
---	------	----------	----------

Testing tap; for max. 2.5 mm²

	gray	2009-182	100 (25)
---	------	----------	----------

Marking strip; plain; 11 mm wide; 50 m reel

	white	2009-110	1
---	-------	----------	---

WMB marking card; white; 10 strips with 10 markers/card; 5 ... 5.2 mm stretchable

	plain	793-5501	5
---	-------	----------	---

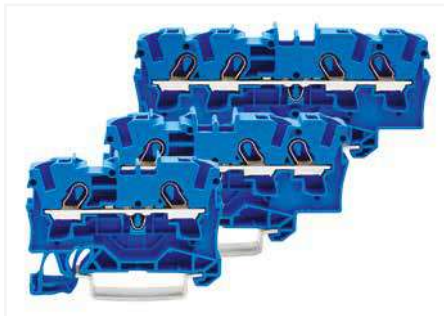

Through terminal blocks with a blue insulated housing are suitable for Ex i applications.



All through and ground conductor terminal blocks are suitable for Ex e II applications.

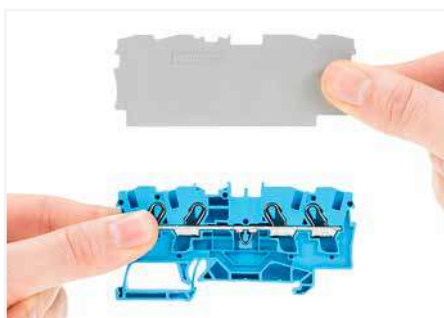

Separator for Ex e/Ex i applications:
An end plate must be applied to the terminal block located directly behind an Ex e/Ex i separator plate.



Ex e II/Ex i terminal strip
Notice:
The movable feet of terminal blocks and separator plates must face the same direction.

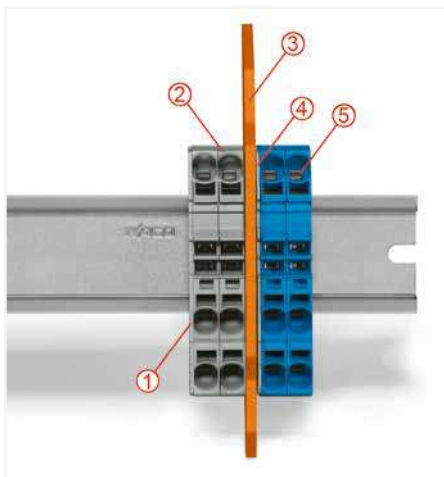

Separator located between Ex e II and Ex i terminal strip
❶ End plate
❷ Ex e II terminal blocks
❸ Separator for Ex e/Ex i applications
❹ End plate
❺ Ex i terminal blocks



Example of marking (rear):
The embossed details on the terminal blocks show the manufacturer's name, the series no., the type of protection Ex e II, the approval no., the approval data and the name of the testing authority.

PUSH-IN CAGE CLAMP®

Through Terminal Block, Ground Conductor Terminal Block, Shield Conductor Terminal Block TOPJOB® S 6 (10) mm²; 2006 Series

1

Technical Data

0.5 ... 6 (10) mm ² ①	20 ... 8 AWG
800 V / 8 kV / 3 ②	600 V, 50 A ③
I _N 41 A (57 A)	600 V, 50 A ④
Terminal block width: 7.5 mm / 0.295 inch	
 13 ... 15 mm / 0.51 ... 0.59 inch	

Technical Data

0.5 ... 6 (10) mm ² ①	20 ... 8 AWG
800 V / 8 kV / 3 ②	600 V, 50 A ③
I _N 41 A (57 A)	600 V, 50 A ④
Terminal block width: 7.5 mm / 0.295 inch	
 13 ... 15 mm / 0.51 ... 0.59 inch	

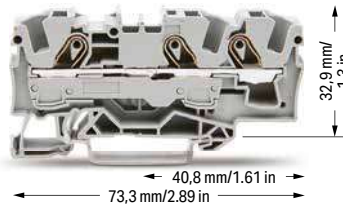

2-conductor through terminal block

Color	Item No.	Pack. Unit
gray ⑤	2006-1201 ④	50
blue ⑤	2006-1204 ③ ④	50
orange ⑤	2006-1202 ④	50
red ⑤	2006-1203 ④	50

3-conductor through terminal block

Color	Item No.	Pack. Unit
gray ⑤	2006-1301 ④	25
blue ⑤	2006-1304 ③ ④	25
orange ⑤	2006-1302 ④	25
red ⑤	2006-1303 ④	25
black ⑤	2006-1305 ④	25
yellow ⑤	2006-1306 ④	25

2-conductor ground terminal block

green-yellow ⑤	2006-1207 ④	50
----------------	-------------	----

3-conductor ground terminal block

green-yellow ⑤	2006-1307 ④	25
----------------	-------------	----

2-conductor shield terminal block

white	2006-1208	50
-------	-----------	----

Accessories; item-specific

End and intermediate plate; 1 mm thick

	orange	2006-1292	100 (25)
	gray	2006-1291	100 (25)

Accessories; item-specific

End and intermediate plate; 1 mm thick

	orange	2006-1392	100 (25)
	gray	2006-1391	100 (25)

Separator; oversized; 2 mm thick

	orange	2006-1294	100 (25)
	gray	2006-1293	100 (25)

Separator; oversized; 2 mm thick

	orange	2006-1394	100 (25)
	gray	2006-1393	100 (25)

Accessories; 2006 Series

Appropriate marking systems: WMB/WMB Inline/Marking strips

Ex e/Ex i separator; orange; 3 mm thick

	120 mm	209-191	50 (25)
--	--------	---------	---------

Protective warning marker; with black high-voltage symbol; for 5 terminal blocks

	yellow	2006-115	100 (25)
---	--------	----------	----------

Push-in type jumper bar; insulated; I_N 41 A; light gray

	2-way	2006-402	25
	3-way	2006-403	25
	4-way	2006-404	25
	5-way	2006-405	25

Lockout cap; for conductor entry and operating slot

	gray	2006-191	25
---	------	----------	----

Push-in type jumper bar; insulated; I_N 41 A; light gray

	1 to 3	2006-433	25
	1 to 4	2006-434	25
	1 to 5	2006-435	25

Modular connector; snaps together; for jumper contact slot

	gray	2006-511	50 (25)
---	------	----------	---------

Star point jumper; insulated; I_N = I_N terminal block; light gray

	1-3-5	2006-405/011-000	25
---	-------	------------------	----

Test plug adapter; for 4 mm Ø test plug

	gray	2009-174	100 (25)
---	------	----------	----------

Step-down jumper; insulated; commons 6/4 mm² (10/12 AWG) to 4/2.5/1.5 mm² (12/14/16 AWG); I_N 32 A

	light gray	2006-499	25
---	------------	----------	----

Marking strip; plain; 11 mm wide; 50 m reel

	white	2009-110	1
---	-------	----------	---

① Conductor range: 0.5 ... 10 mm² "s+f-st"; Push-in termination: 2.5 ... 10 mm² "s" and 2.5 ... 6 mm² "insulated ferrules; 12 mm" Depending on the conductor characteristic, a conductor with a smaller cross section can also be inserted via push-in termination.

② 800 V = rated voltage
8 kV = rated impulse voltage
3 = pollution degree (see Section 15)

③ Terminal blocks with a blue insulated housing are suitable for Ex i applications.

④ Terminal blocks with an Ex mark are suitable for Ex e II applications.
550 V; 38 A; for 2-conductor terminal blocks
550 V; 36 A; for 3-conductor terminal blocks
33 A jumper (see Section 15)

Please observe the application notes:
Separator for Ex e/Ex i applications, see page 61
Step-down jumpers, see page 65
Jumpers, from page 185
Testing accessories, from page 178
Marking, from page 684

Approvals and corresponding ratings, visit www.wago.com



Cover (2006-191) seals unused conductor entry.

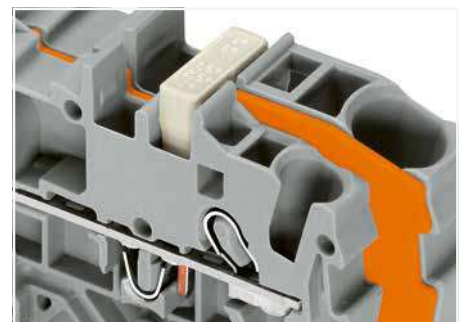

Commoning with step-down jumpers.

Through Terminal Block, Ground Conductor Terminal Block, Shield Conductor Terminal Block TOPJOB® S 10 (16) mm²; 2010 Series

1

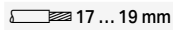
Technical Data	
0.5 ... 10 (16) mm ² ①	20 ... 6 AWG
800 V / 8 kV / 3 ②	600 V, 65 A ^{III}
I _N 57 A (76 A)	600 V, 65 A ^{II}
Terminal block width: 10 mm / 0.394 inch	
 17 ... 19 mm / 0.67 ... 0.75 inch	

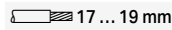
Technical Data	
0.5 ... 10 (16) mm ² ①	20 ... 6 AWG
800 V / 8 kV / 3 ②	600 V, 65 A ^{III}
I _N 57 A (76 A)	600 V, 65 A ^{II}
Terminal block width: 10 mm / 0.394 inch	
 17 ... 19 mm / 0.67 ... 0.75 inch	

① Conductor range: 0.5 ... 16 mm² "s+f-st"; Push-in termination: 4 ... 16 mm² "s" and 4 ... 10 mm² "insulated ferrules; 18 mm"
Depending on the conductor characteristic, a conductor with a smaller cross section can also be inserted via push-in termination.

② 800 V = rated voltage
8 kV = rated impulse voltage
3 = pollution degree (see Section 15)

③ Terminal blocks with a blue housing are suitable for Ex i applications.

④ Terminal blocks with an Ex mark are suitable for Ex e II applications.
550 V; 51 A; for 2-conductor terminal blocks
550 V; 50 A; for 3-conductor terminal blocks (see Section 15)

Please observe the application notes:
Separator for Ex e/Ex i applications, see page 61
Step-down jumpers, see page 65
Jumpers, from page 185
Testing accessories, from page 178
Marking, from page 684

Approvals and corresponding ratings, visit www.wago.com

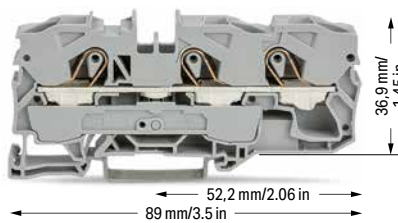
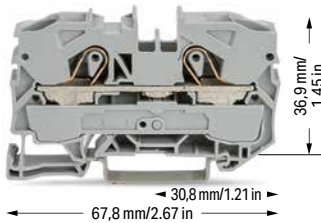

2-conductor through terminal block

Color	Item No.	Pack. Unit
gray ④	2010-1201 ④	25
blue ④	2010-1204 ③ ④	25
orange ④	2010-1202 ④	25
black ④	2010-1205 ④	25
yellow ④	2010-1206 ④	25
light gray ④	2010-1209 ④	25
dark gray-yellow ④	2010-1201/000-053 ④	25

3-conductor through terminal block

Color	Item No.	Pack. Unit
gray ④	2010-1301 ④	25
blue ④	2010-1304 ③ ④	25
orange ④	2010-1302 ④	25
red ④	2010-1303 ④	25
black ④	2010-1305 ④	25
yellow ④	2010-1306 ④	25
light gray ④	2010-1309 ④	25
dark gray-yellow ④	2010-1301/000-053 ④	25

2-conductor ground terminal block

green-yellow ④	2010-1207 ④	25
----------------	-------------	----

3-conductor ground terminal block

green-yellow ④	2010-1307 ④	25
----------------	-------------	----

2-conductor shield terminal block

white	2010-1208	25
-------	-----------	----

Accessories; item-specific

End and intermediate plate; 1 mm thick

orange	2010-1292	100 (25)
gray	2010-1291	100 (25)

Accessories; item-specific

End and intermediate plate; 1 mm thick

orange	2010-1392	100 (25)
gray	2010-1391	100 (25)

Accessories; 2010 Series

Appropriate marking systems: WMB/WMB Inline/Marking strips

Ex e/Ex i separator; orange; 3 mm thick

	120 mm	209-191	50 (25)
---	--------	---------	---------

Protective warning marker; with black high-voltage symbol; for 5 terminal blocks

	yellow	2010-115	100 (25)
---	--------	----------	----------

Push-in type jumper bar; insulated; I_N 57 A; light gray

	2-way	2010-402	25
	3-way	2010-403	25
	4-way	2010-404	25
	5-way	2010-405	25

Finger guard; touch-proof cover protects unused conductor entries

	yellow	2010-100	100 (25)
---	--------	----------	----------

Push-in type jumper bar; insulated; I_N 57 A; light gray

	1 to 3	2010-433	25
	1 to 4	2010-434	25
	1 to 5	2010-435	25

Modular connector; snaps together; for jumper contact slot

	gray	2010-511	50 (25)
---	------	----------	---------

Star point jumper; insulated; I_N = I_N terminal block; light gray

	1-3-5	2010-405/011-000	25
---	-------	------------------	----

Test plug adapter; for 4 mm Ø test plug

	gray	2009-174	100 (25)
---	------	----------	----------

Step-down jumper; insulated; commons 16/10 mm² (8/10 AWG) to 10/6/4/2.5 mm² (8/10/12/14 AWG); I_N 57 A

	light gray	2016-499	25
---	------------	----------	----

WMB marking card; white; 10 strips with 10 markers/card; 5 ... 5.2 mm stretchable

	plain	793-5501	5
---	-------	----------	---

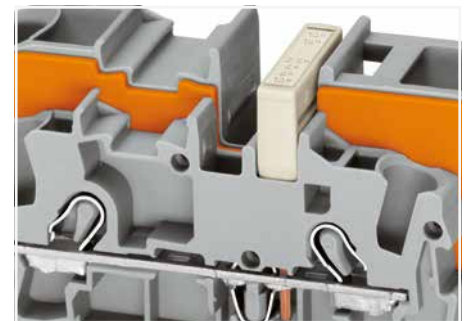

Commoning with step-down jumpers.

PUSH-IN CAGE CLAMP®

Through Terminal Block, Ground Conductor Terminal Block, Shield Conductor Terminal Block TOPJOB® S 16 (25 "f-st") mm²; 2016 Series

1

Technical Data	
0.5 ... 16 (25 "f-st") mm ² ①	20 ... 4 AWG
800 V / 8 kV / 3 ②	600 V, 85 A ③
I _N 76 A (90 A)	600 V, 80 A ④
Terminal block width: 12 mm / 0.472 inch	
18 ... 20 mm / 0.71 ... 0.79 inch	

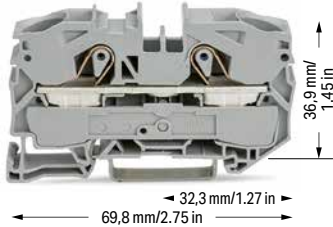

Technical Data	
0.5 ... 16 (25 "f-st") mm ² ①	20 ... 4 AWG
800 V / 8 kV / 3 ②	600 V, 85 A ③
I _N 76 A (90 A)	600 V, 80 A ④
Terminal block width: 12 mm / 0.472 inch	
18 ... 20 mm / 0.71 ... 0.79 inch	

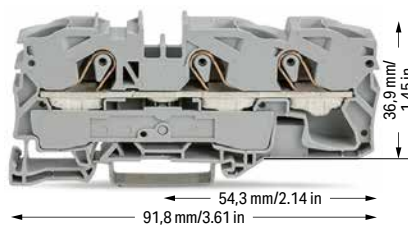

① Conductor range: 0.5 ... 16 mm² "s+f-st", 25 mm² "f-st";
Push-in termination: 6 ... 16 mm² "s" and 6 ... 16 mm² "insulated ferrules; 18 mm"
Depending on the conductor characteristic, a conductor with a smaller cross section can also be inserted via push-in termination.

② 800 V = rated voltage
8 kV = rated impulse voltage
3 = pollution degree
(see Section 15)

③ Terminal blocks with a blue insulated housing are suitable for Ex i applications.

④ Terminal blocks with an Ex mark are suitable for Ex e II applications.
550 V; 70 A; for 2-conductor terminal blocks
550 V; 67 A; for 3-conductor terminal blocks
65 A jumper
(see Section 15)

Please observe the application notes:
Separator for Ex e/Ex i applications, see page 61
Step-down jumpers, see page 65
Jumpers, from page 185
Testing accessories, from page 179
Marking, from page 684

Approvals and corresponding ratings, visit www.wago.com

2-conductor through terminal block		
Color	Item No.	Pack. Unit
gray ⑤	2016-1201 ④	20
blue ⑤	2016-1204 ③ ④	20
orange ⑤	2016-1202 ④	20
red ⑤	2016-1203 ④	20
black ⑤	2016-1205 ④	20
dark gray-yellow ⑤	2016-1201/000-053 ④	20

3-conductor through terminal block		
Color	Item No.	Pack. Unit
gray ⑤	2016-1301 ④	20
blue ⑤	2016-1304 ③ ④	20
orange ⑤	2016-1302 ④	20
red ⑤	2016-1303 ④	20
black ⑤	2016-1305 ④	20
yellow ⑤	2016-1306 ④	20
dark gray-yellow ⑤	2016-1201/000-053 ④	20

2-conductor ground terminal block 15 mm high DIN-35 rails shall be used for a current load higher than 76 A!		
green-yellow ⑤	2016-1207 ④	20

3-conductor ground terminal block 15 mm high DIN-35 rails shall be used for a current load higher than 76 A!		
green-yellow ⑤	2016-1307 ④	20

2-conductor shield terminal block 15 mm high DIN-35 rails shall be used for a current load higher than 76 A!		
white	2016-1208	20

Accessories; item-specific			
End and intermediate plate; 1 mm thick			
	orange	2016-1292	100 (25)
	gray	2016-1291	100 (25)

Accessories; item-specific			
End and intermediate plate; 1 mm thick			
	orange	2016-1392	100 (25)
	gray	2016-1391	100 (25)

Accessories; 2016 Series
Appropriate marking systems: WMB/WMB Inline/Marking strips

Ex e/Ex i separator; orange; 3 mm thick			
	120 mm	209-191	50 (25)

Protective warning marker; with black high-voltage symbol; for 5 terminal blocks			
	yellow	2016-115	100 (25)

Push-in type jumper bar; insulated; I _N 76 A; light gray			
	2-way	2016-402	25
	3-way	2016-403	25
	4-way	2016-404	25
	5-way	2016-405	25

Finger guard; touch-proof cover protects unused conductor entries			
	yellow	2016-100	100 (25)

Push-in type jumper bar; insulated; I _N 76 A; light gray			
	1 to 3	2016-433	25
	1 to 4	2016-434	25
	1 to 5	2016-435	25

Modular connector; snaps together; for jumper contact slot			
	gray	2016-511	50 (25)

Star point jumper; insulated; I _N = I _N terminal block; light gray			
	1-3-5	2016-405/011-000	25

Test plug adapter; for 4 mm Ø test plug			
	gray	2009-174	100 (25)

Step-down jumper; insulated; commons 16/10 mm ² (8/10 AWG) to 10/6/4/2.5 mm ² (8/10/12/14 AWG); I _N 57 A			
	light gray	2016-499	25



Finger guard seals an unused conductor entry.

Step-Down Jumpers TOPJOB® S Installation



Step-down jumpers (2006-499 and 2016-499)

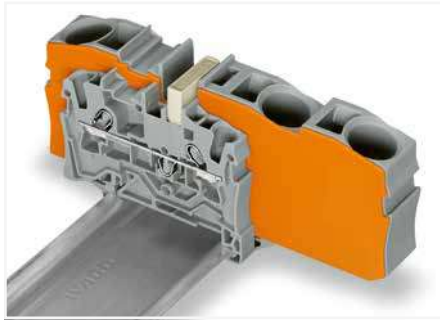

Step-down jumpers common terminal blocks of different sizes, without losing a conductor clamping point. This can be beneficial on long conductor runs where voltage drop can be a problem. A large conductor can be easily connected to smaller conductors at the distribution point. Commoning may be made in either direction using the special thin end plate to cover the open side. Additional through terminal blocks having a smaller cross-section may be commoned using push-in type jumper bars.

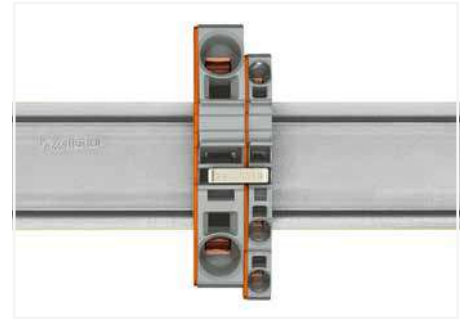

Using step-down jumpers, an end plate must be inserted between the terminal blocks to be commoned.

1



Step-down jumper (2006-499) commons 6/4 mm² (10/12 AWG) terminal blocks (2006/2004 Series) with 4/2.5/1.5 mm² (AWG 12/14/16) terminal blocks (2004/2002/2001 Series).



Step-down jumper (2016-499) commons 16/10 mm² (16/8 AWG) terminal blocks (2016/2010 Series) with 10/6/4/2.5 mm² (8/10/12/14 AWG) terminal blocks (2010/2006/2004/2002 Series).



Stepping down via push-in type jumper bar: Commoning via open terminal side with end plate allows jumpering over two cross-section sizes for 16 mm² (6 AWG) and 10 mm² (8 AWG) and one cross-section size for 6/4/2.5 mm² (10/12/14 AWG). An example: from 16 mm² (6 AWG) to 6 mm² (10 AWG) (see illustration above) or from 10 mm² (8 AWG) to 4 mm² (12 AWG).

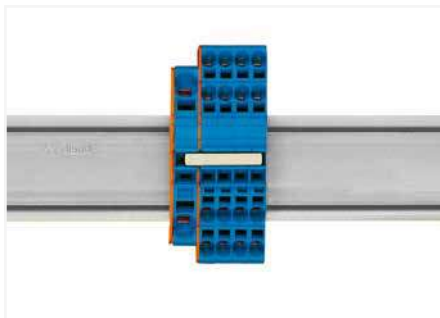

Stepping down via push-in type jumper bar: Commoning via closed terminal side with end plate allows jumpering over two cross-section sizes, e.g., from 16 mm² (6 AWG) to 6 mm² (10 AWG) or from 6 mm² (10 AWG) to 2.5 mm² (14 AWG) (see illustration above).

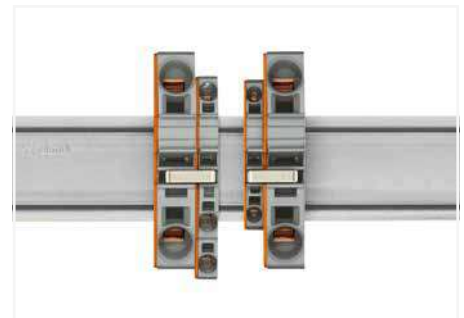

Note: The total current of the outgoing circuits must not exceed the nominal current of the step-down jumper/push-in type jumper bar.

Distribution Terminal Blocks TOPJOB® S; with Push-Button

1 x 6 (10) mm² and 6 x 1.5 (2.5) mm²; 2206 Series

Technical Data

0.5 ... 6 (10) mm² ① | 20 ... 8 AWG

0.25 ... 1.5 (2.5) mm² ② | 22 ... 14 AWG

I_N 41 A (57 A)

800 V / 8 kV / 3 ③

Terminal block width: 9 mm / 0.354 inch

13 ... 15 mm / 0.51 ... 0.59 inch ①

9 ... 11 mm / 0.35 ... 0.43 inch ②

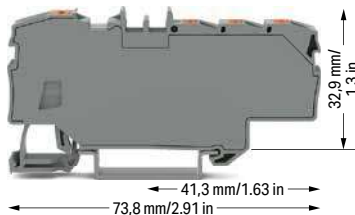

Distribution terminal block; with push-button

Color	Item No.	Pack. Unit
gray	2206-8031	12
blue	2206-8034 ④	12
red	2206-8033	12
black	2206-8035	12
dark gray-yellow	2206-8031/000-053	12

Accessories; distribution terminal block

Appropriate marking systems:
WMB/WMB Inline/Marking strips

Push-in type jumper bar; insulated; I_N 18 A; light gray

	2-way	2001-402	25
	3-way	2001-403	25
	4-way	2001-404	25

Modular connector; snaps together; for jumper contact slot

	gray	2001-511	100 (25)
--	------	----------	----------

Test plug adapter; for 4 mm Ø test plug

	gray	2009-174	100 (25)
--	------	----------	----------

Testing tap; for max. 2.5 mm²

	gray	2009-182	100 (25)
--	------	----------	----------

Marking strip; plain; 11 mm wide; 50 m reel

	white	2009-110	1
--	-------	----------	---

WMB Inline; plain; 1,500 WMB markers (5 mm)/reel; stretchable 5 ... 5.2 mm

	white	2009-115	1
--	-------	----------	---

WMB marker card; white; 10 strips with 10 markers/card; stretchable 5 ... 5.2 mm

	plain	793-5501	5
--	-------	----------	---

① Conductor range: 0.5 ... 10 mm² "s+f-st"
Push-in termination: 2.5 ... 10 mm² "s" and 2.5 ... 6 mm²
"insulated ferrules, 12 mm"
Depending on the conductor characteristic, a conductor with a smaller cross-section can also be inserted via push-in termination.

② Conductor range: 0.25 ... 2.5 mm² "s+f-st"
Push-in termination: 0.75 ... 2.5 mm² "s" and 0.75 ... 1.5 mm²
"insulated ferrules, 12 mm"
Depending on the conductor characteristic, a conductor with a smaller cross-section can also be inserted via push-in termination.

③ 800 V = rated voltage
8 kV = rated impulse voltage
3 = pollution degree
(see Section 15)

④ Terminal blocks with a blue insulated housing are suitable for Ex i applications.

Please observe the application notes:
Jumpers, from page 185
Testing accessories, from page 176
Marking, from page 684

Approvals and corresponding ratings,
visit www.wago.com

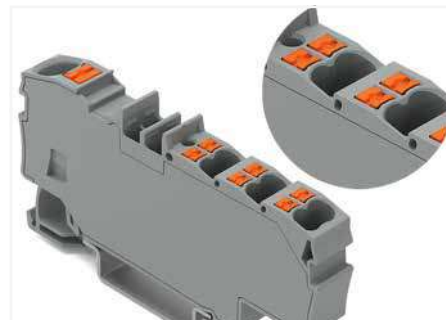

A clear marking of clamping units is molded in.

Distribution Terminal Blocks TOPJOB® S

1 x 6 (10) mm² and 6 x 1.5 (2.5) mm²; 2006 Series

Technical Data

0.5 ... 6 (10) mm² ① | 20 ... 8 AWG0.25 ... 1.5 (2.5) mm² ② | 22 ... 14 AWGI_N 41 A (57 A)

800 V / 8 kV / 3 ③

Terminal block width: 9 mm / 0.354 inch

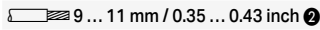
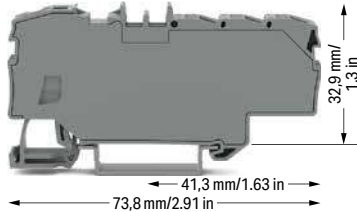
 13 ... 15 mm / 0.51 ... 0.59 inch ① 9 ... 11 mm / 0.35 ... 0.43 inch ②

Distribution terminal block; with operating slot

Color	Item No.	Pack. Unit
gray	2006-8031	12
blue	2006-8034 ④	12
red	2006-8033	12
black	2006-8035	12
dark gray-yellow	2006-8031/000-053	12

Accessories; distribution terminal block

Appropriate marking systems:
WMB/WMB Inline/Marking strips

Push-in type jumper bar; insulated; I_N 18 A; light gray

	2-way	2001-402	25
	3-way	2001-403	25
	4-way	2001-404	25

Modular connector; snaps together; for jumper contact slot

	gray	2001-511	100 (25)
---	------	----------	----------

Test plug adapter; for 4 mm Ø test plug

	gray	2009-174	100 (25)
---	------	----------	----------

Testing tap; for max. 2.5 mm²

	gray	2009-182	100 (25)
---	------	----------	----------

Marking strip; plain; 11 mm wide; 50 m reel

	white	2009-110	1
---	-------	----------	---

WMB Inline; plain; 1,500 WMB markers (5 mm)/reel; stretchable 5 ... 5.2 mm

	white	2009-115	1
---	-------	----------	---

WMB marker card; white; 10 strips with 10 markers/card; stretchable 5 ... 5.2 mm

	plain	793-5501	5
---	-------	----------	---

① Conductor range: 0.5 ... 10 mm² "s+f-st"
Push-in termination: 2.5 ... 10 mm² "s" and 2.5 ... 6 mm²
"insulated ferrules, 12 mm"
Depending on the conductor characteristic, a conductor with a smaller cross-section can also be inserted via push-in termination.

② Conductor range: 0.25 ... 2.5 mm² "s+f-st"
Push-in termination: 0.75 ... 2.5 mm² "s" and 0.75 ... 1.5 mm²
"insulated ferrules, 12 mm"
Depending on the conductor characteristic, a conductor with a smaller cross-section can also be inserted via push-in termination.

③ 800 V = rated voltage
8 kV = rated impulse voltage
3 = pollution degree
(see Section 15)

④ Terminal blocks with a blue insulated housing are suitable for Ex i applications.

Please observe the application notes:
Jumpers, from page 185
Testing accessories, from page 176
Marking, from page 684

Approvals and corresponding ratings,
visit www.wago.com

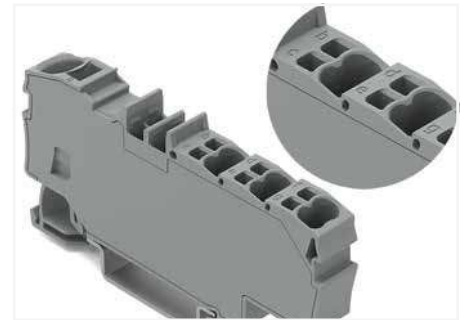

A clear marking of clamping units is molded in.

1

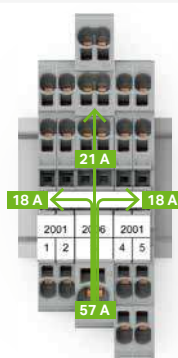

Commoning options for the 2006 Series Distribution Terminal Blocks and 2001 Series Terminal Blocks using 2001 Series Jumpers

Note:

The total current of the outgoing circuits must not exceed the nominal current of the push-in type jumper bar.

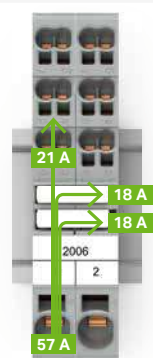

Commoning options for the 2006 Series Distribution Terminal Blocks and 2001 Series Terminal Blocks using 2001 Series Jumpers

Note:

The total current of the outgoing circuits must not exceed the nominal current of the push-in type jumper bar.

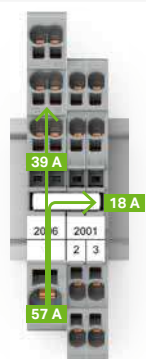

Commoning options for the 2006 Series Distribution Terminal Blocks and 2001 Series Terminal Blocks using 2001 Series Jumpers

Note:

The total current of the outgoing circuits must not exceed the nominal current of the push-in type jumper bar.

Electrical Interconnection Set and Rail-Mount Terminal Block Set 821 Series



Electrical interconnection set; L-BOXX® 102; 221 Series & TOPJOB® S with Lever

	Item No.	Pack. Unit
	821-153	1

Contents

Qty.	Item No.	Description
		COMPACT Splicing Connectors
100	221-412	COMPACT splicing connector; 2 wires; 0.14 ... 4 mm ² ; with levers; transparent
50	221-413	COMPACT splicing connector; 3 wires; 0.14 ... 4 mm ² ; with levers; transparent
25	221-415	COMPACT splicing connector; 5 wires; 0.14 ... 4 mm ² ; with levers; transparent
50	221-612	COMPACT splicing connector; 2 wires; 0.5 ... 6 mm ² ; with levers; transparent
30	221-613	COMPACT splicing connector; 3 wires; 0.5 ... 6 mm ² ; with levers; transparent
15	221-615	COMPACT splicing connector; 5 wires; 0.5 ... 6 mm ² ; with levers; transparent
		TOPJOB® S Rail-Mount Terminal Blocks
60	2102-1201	2-conductor through terminal block; with lever and Push-in CAGE CLAMP®; 0.25 ... 2.5 (4) mm ² ; gray
12	2106-1201	2-conductor through terminal block; with lever and Push-in CAGE CLAMP®; 0.5 ... 6 (10) mm ² ; gray
		Accessories
1	210-110	Felt-tip pen; smudge-proof
5	221-500	Mounting carrier; 221 Series – 4 mm ² ; for DIN-35 rail/screw mounting; orange
3	221-510	Mounting carrier; 221 Series – 6 mm ² ; for DIN-35 rail/screw mounting; orange
10	249-116	Screwless end stop; for DIN-35 rail; 6 mm wide; gray
2	793-5501	WMB marker card; plain
2	793-5566	WMB marker card; marking 1 ... 50
25	2002-400	Continuous jumper; insulated; 2-way; Nominal current: 25 A; light gray
25	2006-402	Push-in type jumper bar; insulated; 2-way; Nominal current: 41 A; light gray
1	2009-310	Operating tool; 3.5 x 0.5 mm and 5.5 x 0.8 mm blades
15	2102-1292	End and intermediate plate; for 2-conductor terminal blocks; orange
5	2106-1292	End and intermediate plate; for 2-conductor terminal blocks; orange

Rail-mount terminal block set; L-BOXX® 102; 20xx, 21xx, 22xx Series

	Item No.	Pack. Unit
	821-154	1

Contents

Qty.	Item No.	Description
		TOPJOB® S Rail-Mount Terminal Blocks
10	2002-1301	3-conductor through terminal block; with Push-in CAGE CLAMP®; 0.25 ... 2.5 (4) mm ² ; gray
8	2004-1201	2-conductor through terminal block; with Push-in CAGE CLAMP®; 0.5 ... 4 (6) mm ² ; gray
20	2102-1201	2-conductor through terminal block; with lever and Push-in CAGE CLAMP®; 0.25 ... 2.5 (4) mm ² ; gray
6	2102-5301	3-conductor through terminal block; with lever and push-button; 0.25 ... 2.5 (4) mm ² ; gray
2	2102-5304	3-conductor through terminal block; with lever and push-button; 0.25 ... 2.5 (4) mm ² ; blue
2	2102-5307	3-conductor ground terminal block; with lever and push-button; 0.25 ... 2.5 (4) mm ² ; green-yellow
6	2106-5301	3-conductor through terminal block; with lever and push-button; 0.5 ... 6 (10) mm ² ; gray
2	2106-5304	3-conductor through terminal block; with lever and push-button; 0.5 ... 6 (10) mm ² ; blue
2	2106-5307	3-conductor ground terminal block; with lever and push-button; 0.5 ... 6 (10) mm ² ; green-yellow
6	2116-5301	3-conductor through terminal block; with lever and push-button; 0.5 ... 16 (25) mm ² ; gray
2	2116-5304	3-conductor through terminal block; with lever and push-button; 0.5 ... 16 (25) mm ² ; blue
2	2116-5307	3-conductor ground terminal block; with lever and push-button; 0.5 ... 16 (25) mm ² ; green-yellow
25	2200-1401	4-conductor through terminal block; with push-button; 0.14 ... 1 (1.5) mm ² ; gray
10	2202-1301	3-conductor through terminal block; with push-button; 0.25 ... 2.5 (4) mm ² ; gray
8	2204-1201	2-conductor through terminal block; with push-button; 0.5 ... 4 (6) mm ² ; gray
6	2210-1201	2-conductor through terminal block; with push-button; 0.5 ... 10 (16) mm ² ; gray
2	2210-1204	2-conductor through terminal block; with push-button; 0.5 ... 10 (16) mm ² ; blue
2	2210-1207	2-conductor ground terminal block; with push-button; 0.5 ... 10 (16) mm ² ; green-yellow

Contents 821-154 (continued)

Qty.	Item No.	Description
		Accessories
10	249-116	Screwless end stop; for DIN-35 rail; 6 mm wide; gray
25	2000-402	Push-in type jumper bar; insulated; 2-way; Nominal current: 14 A; light gray
10	2000-1491	End and intermediate plate; for 4-conductor terminal blocks; gray
25	2002-400	Continuous jumper; insulated; 2-way; Nominal current: 25 A; light gray
25	2002-402	Push-in type jumper bar; insulated; 2-way; Nominal current: 25 A; light gray
10	2002-1391	End and intermediate plate; for 3-conductor terminal blocks; gray
10	2004-402	Push-in type jumper bar; insulated; 2-way; Nominal current: 32 A; light gray
10	2004-1291	End and intermediate plate; for 2-conductor terminal blocks; gray
10	2006-402	Push-in type jumper bar; insulated; 2-way; Nominal current: 41 A; light gray
5	2010-402	Push-in type jumper bar; insulated; 2-way; Nominal current: 57 A; light gray
5	2010-1291	End and intermediate plate; for 2-conductor terminal blocks; gray
10	2016-402	Push-in type jumper bar; insulated; 2-way; Nominal current: 76 A; light gray
10	2102-1291	End and intermediate plate; for 2-conductor terminal blocks; gray
5	2102-1391	End and intermediate plate; for 3-conductor terminal blocks; gray
5	2106-1391	End and intermediate plate; for 3-conductor terminal blocks; gray
5	2116-1391	End and intermediate plate; for 3-conductor terminal blocks; gray

Rail-mount terminal block set; L-BOXX® 102; 2002, 2006, 2016 Series

	Item No.	Pack. Unit
	821-155	1

Contents

Qty.	Item No.	Description
		TOPJOB® S Rail-Mount Terminal Blocks
75	2002-1201	2-conductor through terminal block; 0.25 ... 2.5 (4) mm ² ; gray
25	2002-1204	2-conductor through terminal block; 0.25 ... 2.5 (4) mm ² ; blue
25	2002-1207	2-conductor ground terminal block; 0.25 ... 2.5 (4) mm ² ; green-yellow
9	2006-1201	2-conductor through terminal block; 0.5 ... 6 (10) mm ² ; gray
3	2006-1204	2-conductor through terminal block; 0.5 ... 6 (10) mm ² ; blue
3	2006-1207	2-conductor ground terminal block; 0.5 ... 6 (10) mm ² ; green-yellow
12	2016-1201	2-conductor through terminal block; 0.5 ... 16 (25) mm ² ; gray
6	2016-1204	2-conductor through terminal block; 0.5 ... 16 (25) mm ² ; blue
6	2016-1207	2-conductor ground terminal block; 0.5 ... 16 (25) mm ² ; green-yellow
		Accessories
1	210-110	Felt-tip pen; smudge-proof
1	210-722	Operating tool set; with a partially insulated shaft
5	249-119	Height-adjustable group marker carrier
10	249-117	Screwless end stop; for DIN-35 rail; 10 mm wide; gray
2	793-5501	WMB marker card; plain
2	793-5566	WMB marker card; marking 1 ... 50
1	793-5472	WMB marker card; Marking L1, L2, L3, N, PE
25	2002-400	Continuous jumper; insulated; 2-way; Nominal current: 25 A; light gray
25	2002-1292	End and intermediate plate; for 2-conductor terminal blocks; orange
25	2006-402	Push-in type jumper bar; insulated; 2-way; Nominal current: 41 A; light gray
10	2006-1292	End and intermediate plate; for 2-conductor terminal blocks; orange
1	2009-110	Marking strip; white; 1 m long
5	2009-182	Testing tap; for max. 2.5 mm ²
1	2009-310	Operating tool; 3.5 x 0.5 mm and 5.5 x 0.8 mm blades
25	2016-402	Push-in type jumper bar; insulated; 2-way; Nominal current: 76 A; light gray
10	2016-1292	End and intermediate plate; for 2-conductor terminal blocks; orange

PUSH-IN CAGE CLAMP®

Double-Deck Terminal Block TOPJOB® S; with Push-Button; with Vertical Conductor Entry

2.5 (4) mm²; 2202 Series

1

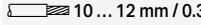
Technical Data	
0.25 ... 2.5 (4) mm ² ①	22 ... 12 AWG
800 V / 8 kV / 3 ②	600 V, 20 A ③
I _N 24 A	600 V, 24 A ④
Terminal block width: 5.2 mm / 0.205 inch	
 10 ... 12 mm / 0.39 ... 0.47 inch	

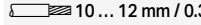
Technical Data	
0.25 ... 2.5 (4) mm ² ①	22 ... 12 AWG
800 V / 8 kV / 3 ②	600 V, 20 A ③
I _N 24 A	600 V, 24 A ④
Terminal block width: 5.2 mm / 0.205 inch	
 10 ... 12 mm / 0.39 ... 0.47 inch	

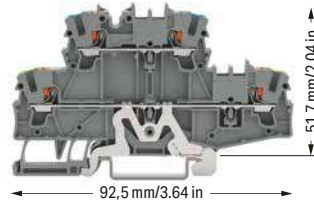

Double-deck terminal block; with push-button; through/through terminal block; with vertical conductor entry; without marker carrier; gray

	Item No.	Pack. Unit
<input type="radio"/> L/L ⑤	2202-2701 ④	50
<input type="radio"/> N/L ⑤	2202-2702 ④	50
<input type="radio"/> L/N ⑤	2202-2703 ④	50

Double-deck terminal block; with push-button; ground conductor/through terminal block; with vertical conductor entry; without marker carrier; gray

	Item No.	Pack. Unit
<input type="radio"/> PE/N ⑤	2202-2717 ④	50
<input type="radio"/> PE/L ⑤	2202-2727 ④	50

Double-deck terminal block; with push-button; through/through terminal block; with vertical conductor entry; without marker carrier; blue

<input type="radio"/> N/N ⑤	2202-2704 ③ ④	50
-----------------------------	---------------	----

Double-deck terminal block; with push-button; through/through terminal block; with vertical conductor entry; with marker carrier; gray

<input type="radio"/> L/L ⑤	2202-2731 ④	50
-----------------------------	-------------	----

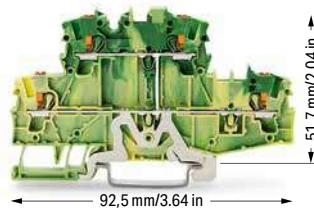
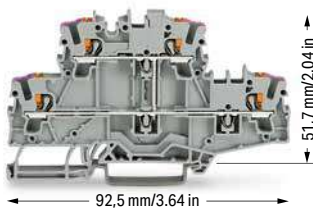

Double-deck terminal block; with push-button; 4-conductor through terminal block; with vertical conductor entry; without marker carrier; Internally commoned; violet conductor entry; gray

	Item No.	Pack. Unit
<input type="radio"/> L ⑤	2202-2708 ④	50

Double-deck terminal block; with push-button; 4-conductor ground terminal block; with vertical conductor entry; without marker carrier; Internally commoned; green-yellow

<input checked="" type="radio"/> PE ⑤	2202-2707 ④	50
---------------------------------------	-------------	----

Double-deck terminal block; with push-button; 4-conductor through terminal block; with vertical conductor entry; without marker carrier; Internally commoned; violet conductor entry; blue

<input checked="" type="radio"/> N ⑤	2202-2709 ③ ④	50
--------------------------------------	---------------	----

- ① Conductor range: 0.25 ... 4 mm² "s+f-st"
Push-in termination: 1 ... 4 mm² "s" and 1 ... 2.5 mm² "insulated ferrules, 12 mm"
Depending on the conductor characteristic, a conductor with a smaller cross section can also be inserted via push-in termination.
- ② 800 V = rated voltage
8 kV = rated impulse voltage
3 = pollution degree (see Section 15)
- ③ Terminal blocks with a blue insulated housing are suitable for Ex i applications.
- ④ Terminal blocks with an Ex mark are suitable for Ex e II applications.
550 V; 17.5 A
17 A jumper (see Section 15)

Please observe the application notes:
Jumpers, from page 182
Testing accessories, page 181
Marking, from page 684

Approvals and corresponding ratings, visit www.wago.com

Accessories; 2202 Series
Appropriate marking systems:
WMB/WMB Inline/Marking strips

End and intermediate plate; 0.8 mm thick

	orange	2002-2792	100 (25)
	gray	2002-2791	100 (25)

Ex e/Ex i separator; orange; 3 mm thick

	125.5 mm	209-192	50 (25)
---	----------	---------	---------

Insulation stop; 5 pcs/strip; 0.25 ... 0.5 mm²

	light gray	2002-171	200 (25)
---	------------	----------	----------

Insulation stop; 5 pcs/strip; 0.75 ... 1 mm²

	dark gray	2002-172	200 (25)
---	-----------	----------	----------

Push-in type jumper bar; insulated; I_N 25 A; light gray

	2-way	2002-402	25
	3-way	2002-403	25
	4-way	2002-404	25
	5-way	2002-405	25
	6-way	2002-406	25
	7-way	2002-407	25
	8-way	2002-408	25
	9-way	2002-409	25
	10-way	2002-410	25

Push-in type jumper bar; insulated; I_N 25 A; light gray

	1 to 3	2002-433	25
	1 to 4	2002-434	25
	1 to 5	2002-435	25
	1 to 6	2002-436	25
	1 to 7	2002-437	25
	1 to 8	2002-438	25
	1 to 9	2002-439	25
	1 to 10	2002-440	25

Double-deck vertical jumper; insulated; I_N 24 A

	light gray	2002-492	100 (25)
	orange	2002-492/000-012	100 (25)

Double-deck marker carrier; pivoting

	gray	2002-121	50 (25)
---	------	----------	---------

Double-Deck Terminal Block TOPJOB® S

1 (1.5) mm²; 2000 Series

1

Technical Data

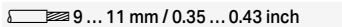
0.14 ... 1 (1.5) mm² ① | 24 ... 16 AWG
 500 V / 6 kV / 3 ② | 600 V, 10 A ③
 I_N 13.5 A (16 A)
 Terminal block width: 3.5 mm / 0.138 inch
 9 ... 11 mm / 0.35 ... 0.43 inch

Technical Data

0.14 ... 1 (1.5) mm² ① | 24 ... 16 AWG
 500 V / 6 kV / 3 ② | 600 V, 10 A ③
 I_N 13.5 A (16 A)
 Terminal block width: 3.5 mm / 0.138 inch
 9 ... 11 mm / 0.35 ... 0.43 inch

Technical Data

0.14 ... 1 (1.5) mm² ① | 24 ... 16 AWG
 500 V / 6 kV / 3 ② | 600 V, 10 A ③
 I_N 13.5 A (16 A)
 Terminal block width: 3.5 mm / 0.138 inch
 9 ... 11 mm / 0.35 ... 0.43 inch

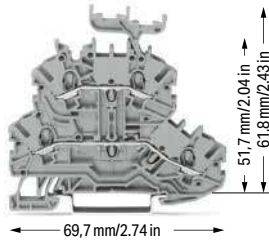

69,7 mm/2.74 in

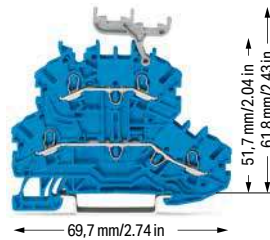

69,7 mm/2.74 in

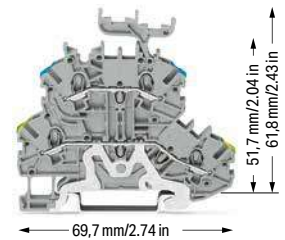

69,7 mm/2.74 in

Double-deck terminal block; through/through terminal block; with marker carrier; gray

	Item No.	Pack. Unit
○ L/L ④	2000-2231 ④	50
○ N/L ④	2000-2232 ④	50
○ L/N ④	2000-2233 ④	50

Double-deck terminal block; through/through terminal block; with marker carrier; blue

	Item No.	Pack. Unit
● N/N ④	2000-2234 ③ ④	50

Double-deck terminal block; ground conductor/through terminal block; with marker carrier; blue

	Item No.	Pack. Unit
○ PE/N ④	2000-2247 ④	50
○ PE/L ④	2000-2257 ④	50

Double-deck terminal block; through/through terminal block; without marker carrier; gray

○ L/L ④	2000-2201 ④	50
○ N/L ④	2000-2202 ④	50
○ L/N ④	2000-2203 ④	50

Double-deck terminal block; through/through terminal block; without marker carrier; blue

● N/N ④	2000-2204 ③ ④	50
---------	---------------	----

Double-deck terminal block; ground conductor/through terminal block; without marker carrier; gray

○ PE/N ④	2000-2217 ④	50
○ PE/L ④	2000-2227 ④	50

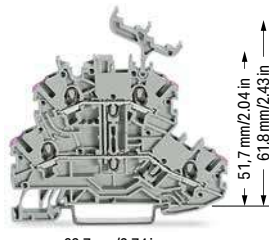

69,7 mm/2.74 in

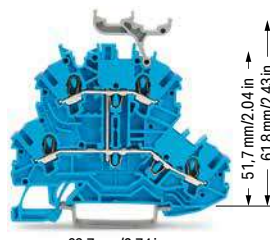

69,7 mm/2.74 in

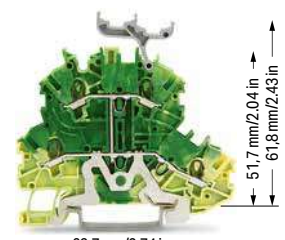

69,7 mm/2.74 in

Double-deck terminal block; 4-conductor through terminal block; with marker carrier; internally commoded; violet conductor entry; gray

	Item No.	Pack. Unit
○ L ④	2000-2238 ④	50

Double-deck terminal block; 4-conductor through terminal block; with marker carrier; internally commoded; violet conductor entry; blue

	Item No.	Pack. Unit
● N ④	2000-2239 ③ ④	50

Double-deck terminal block; 4-conductor ground terminal block; with marker carrier; internally commoded; green-yellow

	Item No.	Pack. Unit
● PE ④	2000-2237 ④	50

Double-deck terminal block; 4-conductor through terminal block; without marker carrier; internally commoded; violet conductor entry; gray

○ L ④	2000-2208 ④	50
-------	-------------	----

Double-deck terminal block; 4-conductor through terminal block; without marker carrier; internally commoded; violet conductor entry; blue

● N ④	2000-2209 ③ ④	50
-------	---------------	----

Double-deck terminal block; 4-conductor ground terminal block; without marker carrier; internally commoded; green-yellow

● PE ④	2000-2207 ④	50
--------	-------------	----

Technical Data

0.14 ... 1 (1.5) mm ² ①	24 ... 16 AWG
500 V / 6 kV / 3 ②	600 V, 10 A ③
I _N 13.5 A (16 A)	
Terminal block width: 3.5 mm / 0.138 inch	
9 ... 11 mm / 0.35 ... 0.43 inch	

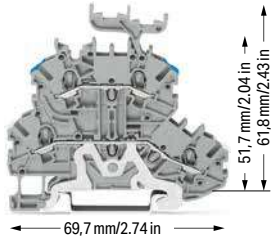

Double-deck terminal block; shield/through terminal block; with marker carrier; gray

	Item No.	Pack. Unit
○ Shield/N	2000-2248	50
○ Shield/L	2000-2258	50

Double-deck terminal block; shield/through terminal block; without marker carrier; gray

○ Shield/N	2000-2218	50
○ Shield/L	2000-2228	50

- Conductor range: 0.14 ... 1.5 mm² "s+f-st"; Push-in termination: 0.5 ... 1.5 mm² "s" and 0.5 ... 0.75 mm² "insulated ferrules; 10 mm" Depending on the conductor characteristic, a conductor with a smaller cross section can also be inserted via push-in termination.
- 800 V = rated voltage
8 kV = rated impulse voltage
3 = pollution degree (see Section 15)
- Terminal blocks with a blue insulated housing are suitable for Ex i applications.
- Terminal blocks with an Ex mark are suitable for Ex e II applications.
350 V; 13 A
12 A jumper (see Section 15)



Please observe the application notes:
Jumpers, from page 182
Testing accessories, page 181
Marking, from page 684

Approvals and corresponding ratings, visit www.wago.com

Accessories; 2000 Series

Appropriate marking systems:
WMB/WMB Inline/Marking strips

End and intermediate plate; 0.7 mm thick

	orange	2000-2292	25
	gray	2000-2291	25

Ex e/Ex i separator; orange; 3 mm thick

	125.5 mm	209-192	50 (25)
---	----------	---------	---------

Push-in type jumper bar; insulated; I_N 13.5 A; light gray

	2-way	2000-402	25
	3-way	2000-403	25
	4-way	2000-404	25
	5-way	2000-405	25
	6-way	2000-406	25
	7-way	2000-407	25
	8-way	2000-408	25
	9-way	2000-409	25
	10-way	2000-410	25

Push-in type jumper bar; insulated; I_N 13.5 A; light gray

	1 to 3	2000-433	25
	1 to 4	2000-434	25
	1 to 5	2000-435	25
	1 to 6	2000-436	25
	1 to 7	2000-437	25
	1 to 8	2000-438	25
	1 to 9	2000-439	25
	1 to 10	2000-440	25

Double-deck vertical jumper; insulated; I_N 13.5 A

	light gray	2000-492	100 (25)
---	------------	----------	----------

Protective warning marker; with black high-voltage symbol; for 5 terminal blocks

	yellow	2000-115	100 (25)
---	--------	----------	----------

Test plug adapter; for 4 mm Ø test plug

	gray	2009-174	100 (25)
---	------	----------	----------

Accessories; 2000 Series

Appropriate marking systems:
WMB/WMB Inline/Marking strips

Testing tap; for max. 2.5 mm²

	gray	2009-182	100 (25)
---	------	----------	----------

Marking strip; plain; 11 mm wide; 50 m reel

	white	2009-110	1
---	-------	----------	---

WMB Inline; plain; 2,300 WMB markers (3.5 mm)/reel

	white	2009-113	1
---	-------	----------	---

WMB marking card; white; 10 strips with 10 markers/card; for 3.5 mm terminal block width

	plain	793-3501	5
---	-------	----------	---

Double-deck marker carrier; pivoting

	gray	2000-121	50 (25)
---	------	----------	---------



Double-deck terminal blocks:

A double-deck marker carrier (2000-121) can be retrofitted to double-deck terminal blocks without a marker carrier.

Double-Deck Terminal Block TOPJOB® S; with End Plate; 800 V 1 (1.5) mm²; 2000 Series

1

Technical Data	
0.14 ... 1 (1.5) mm ² ①	24 ... 16 AWG
800 V / 8 kV / 3 ②	600 V, 10 A ③
I _N 13.5 A (16 A)	
Terminal block width: 4.2 mm / 0.165 inch	
9 ... 11 mm / 0.35 ... 0.43 inch	

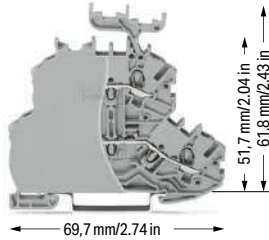

Double-deck terminal block; through/through terminal block; with end plate; with marker carrier; gray

	Item No.	Pack. Unit
○ L/L ④	2000-2231/099-000 ④	50
○ N/L ④	2000-2232/099-000 ④	50
○ L/N ④	2000-2233/099-000 ④	50

Double-deck terminal block; through/through terminal block; with end plate; without marker carrier; gray

○ L/L ④	2000-2201/099-000 ④	50
○ N/L ④	2000-2202/099-000 ④	50
○ L/N ④	2000-2203/099-000 ④	50

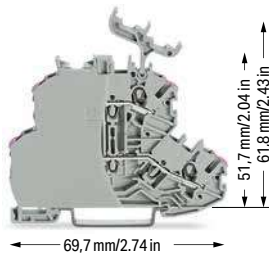

Double-deck terminal block; 4-conductor through terminal block; with end plate; with marker carrier; internally commoded; violet conductor entry; gray

	Item No.	Pack. Unit
○ L ④	2000-2238/099-000 ④	50

Double-deck terminal block; 4-conductor through terminal block; with end plate; without marker carrier; internally commoded; violet conductor entry; gray

○ L ④	2000-2208/099-000 ④	50
-------	---------------------	----

Technical Data	
0.14 ... 1 (1.5) mm ² ①	24 ... 16 AWG
800 V / 8 kV / 3 ②	600 V, 10 A ③
I _N 13.5 A (16 A)	
Terminal block width: 4.2 mm / 0.165 inch	
9 ... 11 mm / 0.35 ... 0.43 inch	

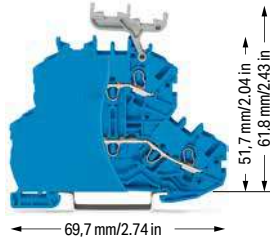

Double-deck terminal block; through/through terminal block; with end plate; with marker carrier; blue

● N/N ④	2000-2234/099-000 ④	50
---------	---------------------	----

Double-deck terminal block; through/through terminal block; with end plate; without marker carrier; blue

● N/N ④	2000-2204/099-000 ④	50
---------	---------------------	----

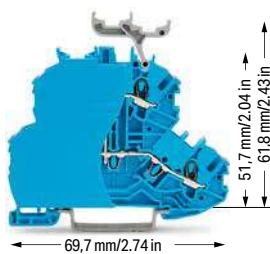

Double-deck terminal block; 4-conductor through terminal block; with end plate; with marker carrier; internally commoded; violet conductor entry; blue

● N ④	2000-2239/099-000 ④	50
-------	---------------------	----

Double-deck terminal block; 4-conductor through terminal block; with end plate; without marker carrier; internally commoded; violet conductor entry; blue

● N ④	2000-2209/099-000 ④	50
-------	---------------------	----

Technical Data	
0.14 ... 1 (1.5) mm ² ①	24 ... 16 AWG
800 V / 8 kV / 3 ②	600 V, 10 A ③
I _N 13.5 A (16 A)	
Terminal block width: 4.2 mm / 0.165 inch	
9 ... 11 mm / 0.35 ... 0.43 inch	

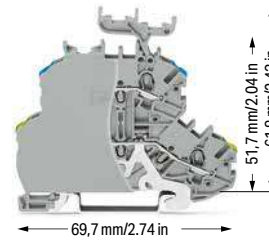

Double-deck terminal block; ground conductor/through terminal block; with end plate; with marker carrier; gray

	Item No.	Pack. Unit
○ PE/N ④	2000-2247/099-000 ④	50
○ PE/L ④	2000-2257/099-000 ④	50

Double-deck terminal block; ground conductor/through terminal block; with end plate; without marker carrier; gray

○ PE/N ④	2000-2217/099-000 ④	50
○ PE/L ④	2000-2227/099-000 ④	50

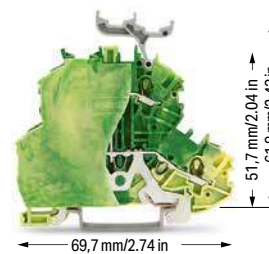

Double-deck terminal block; 4-conductor ground terminal block; with end plate; with marker carrier; internally commoded; green-yellow

● PE ④	2000-2237/099-000 ④	50
--------	---------------------	----

Double-deck terminal block; 4-conductor ground terminal block; with end plate; without marker carrier; internally commoded; green-yellow

● PE ④	2000-2207/099-000 ④	50
--------	---------------------	----

Technical Data

0.14 ... 1 (1.5) mm² ① | 24 ... 16 AWG

800 V / 8 kV / 3 ② | 600 V, 10 A ③

I_N 13.5 A (16 A)

Terminal block width: 4.2 mm / 0.165 inch

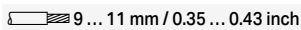
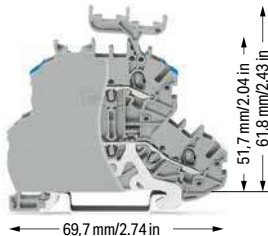
 9 ... 11 mm / 0.35 ... 0.43 inch

Double-deck terminal block; shield/through terminal block; with end plate; with marker carrier; gray

	Item No.	Pack. Unit
○ Shield/N	2000-2248/099-000	50
○ Shield/L	2000-2258/099-000	50

Double-deck terminal block; shield/through terminal block; with end plate; without marker carrier; gray

	Item No.	Pack. Unit
○ Shield/N	2000-2218/099-000	50
○ Shield/L	2000-2228/099-000	50

① Conductor range: 0.14 ... 1.5 mm² "s+f-st"; Push-in termination: 0.5 ... 1.5 mm² "s" and 0.5 ... 0.75 mm² "insulated ferrules; 10 mm" Depending on the conductor characteristic, a conductor with a smaller cross section can also be inserted via push-in termination.

② 800 V = rated voltage
8 kV = rated impulse voltage
3 = pollution degree (see Section 15)

③ Terminal blocks with a blue insulated housing are suitable for Ex i applications.

④ Terminal blocks with an Ex mark are suitable for Ex e II applications.
550 V; 13 A
12 A jumper (see Section 15)

Please observe the application notes:

Jumpers, from page 182

Testing accessories, page 181



Marking, from page 684

Approvals and corresponding ratings, visit www.wago.com

Accessories; 2000 Series

Appropriate marking systems:
WMB/WMB Inline/Marking strips

End and intermediate plate; 0.7 mm thick

	orange	2000-2292	25
	gray	2000-2291	25

Ex e/Ex i separator; orange; 3 mm thick

	125.5 mm	209-192	50 (25)
---	----------	---------	---------

Push-in type jumper bar; insulated; I_N 17.5 A; light gray

	2-way	2001-402	25
	3-way	2001-403	25
	4-way	2001-404	25
	5-way	2001-405	25
	6-way	2001-406	25
	7-way	2001-407	25
	8-way	2001-408	25
	9-way	2001-409	25
	10-way	2001-410	25

Push-in type jumper bar; insulated; I_N 17.5 A; light gray

	1 to 3	2001-433	25
	1 to 4	2001-434	25
	1 to 5	2001-435	25
	1 to 6	2001-436	25
	1 to 7	2001-437	25
	1 to 8	2001-438	25
	1 to 9	2001-439	25
	1 to 10	2001-440	25

Double-deck vertical jumper; insulated; I_N 13.5 A

	light gray	2000-492	100 (25)
---	------------	----------	----------

Protective warning marker; with black high-voltage symbol; for 5 terminal blocks

	yellow	2001-115	100 (25)
---	--------	----------	----------

Test plug adapter; for 4 mm Ø test plug

	gray	2009-174	100 (25)
---	------	----------	----------

Accessories; 2000 Series

Appropriate marking systems:
WMB/WMB Inline/Marking stripsTesting tap; for max. 2.5 mm²

	gray	2009-182	100 (25)
---	------	----------	----------

Marking strip; plain; 11 mm wide; 50 m reel

	white	2009-110	1
---	-------	----------	---

WMB Inline; plain; 2,000 WMB markers (4 mm)/reel; 4 ... 4.2 mm stretchable

	white	2009-114	1
---	-------	----------	---

WMB marking card; white; 10 strips with 10 markers/card; 4 ... 4.2 mm stretchable

	plain	793-4501	5
---	-------	----------	---

Double-deck marker carrier; pivoting

	gray	2000-121	50 (25)
---	------	----------	---------



Double-deck terminal blocks:

A double-deck marker carrier (2000-121) can be retrofitted to double-deck terminal blocks without a marker carrier.

Double-Deck Terminal Block TOPJOB® S

2.5 (4) mm²; 2002 Series

1

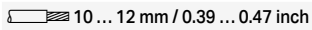
Technical Data	
0.25 ... 2.5 (4) mm ² ①	22 ... 12 AWG
500 V / 6 kV / 3 ②	300 V, 20 A ③
I _N 24 A (28 A)	600 V, 20 A ④
Terminal block width: 5.2 mm / 0.205 inch	
 10 ... 12 mm / 0.39 ... 0.47 inch	

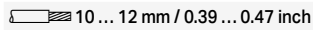
Technical Data	
0.25 ... 2.5 (4) mm ² ①	22 ... 12 AWG
500 V / 6 kV / 3 ②	300 V, 20 A ③
I _N 24 A (28 A)	600 V, 20 A ④
Terminal block width: 5.2 mm / 0.205 inch	
 10 ... 12 mm / 0.39 ... 0.47 inch	

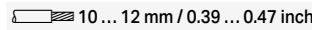
Technical Data	
0.25 ... 2.5 (4) mm ² ①	22 ... 12 AWG
500 V / 6 kV / 3 ②	300 V, 20 A ③
I _N 24 A (28 A)	600 V, 20 A ④
Terminal block width: 5.2 mm / 0.205 inch	
 10 ... 12 mm / 0.39 ... 0.47 inch	

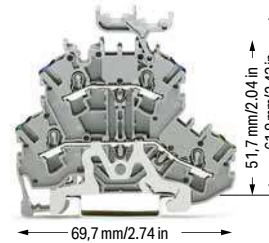
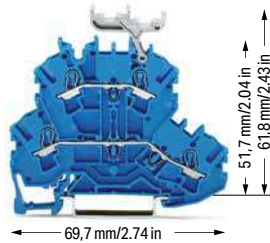
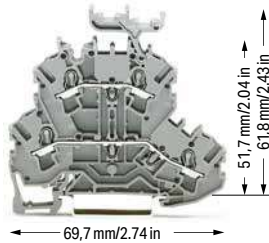

Double-deck terminal block; through/through terminal block; with marker carrier; gray

	Item No.	Pack. Unit
○ L/L ⑤	2002-2231 ④	50
○ N/L ⑤	2002-2232 ④	50
○ L/N ⑤	2002-2233 ④	50

Double-deck terminal block; through/through terminal block; with marker carrier; blue

	Item No.	Pack. Unit
● N/N ⑤	2002-2234 ③ ④	50

Double-deck terminal block; ground conductor/through terminal block; with marker carrier; blue

	Item No.	Pack. Unit
○ PE/N ⑤	2002-2247 ④	50
○ PE/L ⑤	2002-2257 ④	50

Double-deck terminal block; through/through terminal block; without marker carrier; gray

○ L/L ⑤	2002-2201 ④	50
○ N/L ⑤	2002-2202 ④	50
○ L/N ⑤	2002-2203 ④	50

Double-deck terminal block; through/through terminal block; without marker carrier; blue

● N/N ⑤	2002-2204 ③ ④	50
---------	---------------	----

Double-deck terminal block; ground conductor/through terminal block; without marker carrier; gray

○ PE/N ⑤	2002-2217 ④	50
○ PE/L ⑤	2002-2227 ④	50

Double-deck terminal block; through/through terminal block; without marker carrier; orange

● N/L ⑤	2002-2206 ④	50
---------	-------------	----

Other terminal blocks with the same profile:

Diode	2002-2211/1000-410	Page 172
LED	2002-2221/1000-434	Page 172

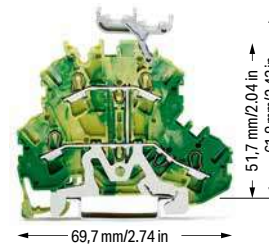
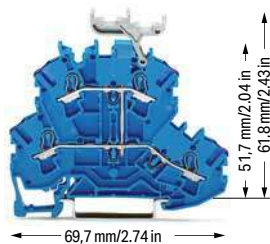
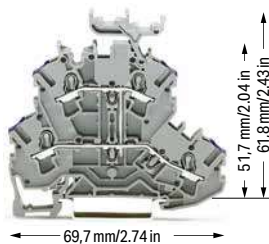

Double-deck terminal block; 4-conductor through terminal block; with marker carrier; internally commoned; violet conductor entry; gray

	Item No.	Pack. Unit
○ L ⑤	2002-2238 ④	50

Double-deck terminal block; 4-conductor through terminal block; with marker carrier; internally commoned; violet conductor entry; blue

	Item No.	Pack. Unit
● N ⑤	2002-2239 ③ ④	50

Double-deck terminal block; 4-conductor ground terminal block; with marker carrier; internally commoned; green-yellow

	Item No.	Pack. Unit
● PE ⑤	2002-2237 ④	50

Double-deck terminal block; 4-conductor through terminal block; without marker carrier; internally commoned; violet conductor entry; gray

○ L ⑤	2002-2208 ④	50
-------	-------------	----

Double-deck terminal block; 4-conductor through terminal block; without marker carrier; internally commoned; violet conductor entry; blue

● N ⑤	2002-2209 ③ ④	50
-------	---------------	----

Double-deck terminal block; 4-conductor ground terminal block; without marker carrier; internally commoned; green-yellow

● PE ⑤	2002-2207 ④	50
--------	-------------	----

Technical Data

0.25 ... 2.5 (4) mm ² ①	22 ... 12 AWG
500 V / 6 kV / 3 ②	300 V, 20 A ③
I _N 24 A (28 A)	600 V, 20 A ④
Terminal block width: 5.2 mm / 0.205 inch	
10 ... 12 mm / 0.39 ... 0.47 inch	

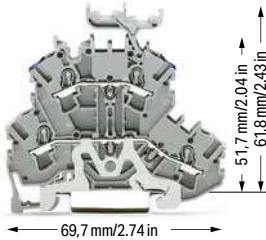

Double-deck terminal block; shield/through terminal block; with marker carrier; gray

	Item No.	Pack. Unit
○ Shield/N	2002-2248	50
○ Shield/L	2002-2258	50

Double-deck terminal block; shield/through terminal block; without marker carrier; gray

○ Shield/N	2002-2218	50
○ Shield/L	2002-2228	50

- Conductor range: 0.25 ... 4 mm² "s+f-st";
Push-in termination: 1 ... 4 mm² "s" and 1 ... 2.5 mm² "insulated ferrules, 12 mm"
Depending on the conductor characteristic, a conductor with a smaller cross section can also be inserted via push-in termination.
- 500 V = rated voltage
6 kV = rated impulse voltage
3 = pollution degree
(see Section 15)
- Terminal blocks with a blue insulated housing are suitable for Ex i applications.
- Terminal blocks with an Ex mark are suitable for Ex e II applications.
440 V; 20 A
18 A jumper
(see Section 15)

Please observe the application notes:
Jumpers, from page 182
Testing accessories, page 181
Marking, from page 684

Approvals and corresponding ratings,
visit www.wago.com

Accessories; 2002 Series

Appropriate marking systems:
WMB/WMB Inline/Marking strips

End and intermediate plate; 0.8 mm thick

	orange	2002-2292	100 (25)
	gray	2002-2291	100 (25)

Ex e/Ex i separator; orange; 3 mm thick

	125.5 mm	209-192	50 (25)
--	----------	---------	---------

Separator plate; oversized upper deck; snap-on type; 2 mm thick

	orange	2002-2296	100 (25)
	gray	2002-2295	100 (25)

Insulation stop; 5 pcs/strip; 0.25 ... 0.5 mm²

	light gray	2002-171	200 (25)
--	------------	----------	----------

Insulation stop; 5 pcs/strip; 0.75 ... 1 mm²

	dark gray	2002-172	200 (25)
--	-----------	----------	----------

Push-in type jumper bar; insulated; I_N 25 A; light gray

	2-way	2002-402	25
	3-way	2002-403	25
	4-way	2002-404	25
	5-way	2002-405	25
	6-way	2002-406	25
	7-way	2002-407	25
	8-way	2002-408	25
	9-way	2002-409	25
	10-way	2002-410	25

Push-in type jumper bar; insulated; I_N 25 A; light gray

	1 to 3	2002-433	25
	1 to 4	2002-434	25
	1 to 5	2002-435	25
	1 to 6	2002-436	25
	1 to 7	2002-437	25
	1 to 8	2002-438	25
	1 to 9	2002-439	25
	1 to 10	2002-440	25

Accessories; 2002 Series

Appropriate marking systems:
WMB/WMB Inline/Marking strips

Double-deck vertical jumper; insulated; I_N 24 A

	light gray	2002-492	100 (25)
	orange	2002-492/000-012	100 (25)

Double-deck marker carrier; pivoting

	gray	2002-121	50 (25)
--	------	----------	---------

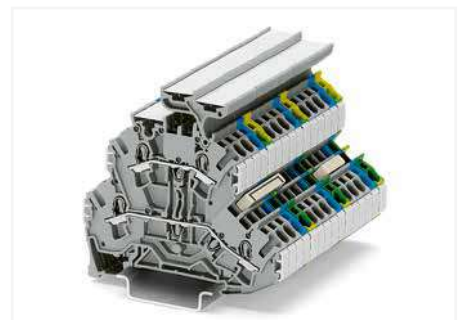

Double-deck terminal block assembly

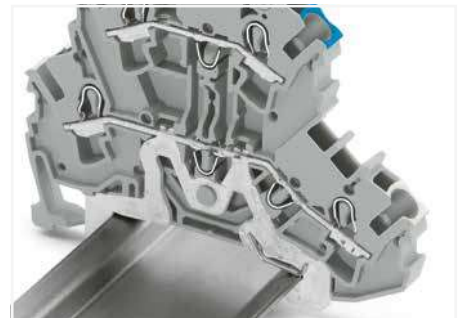

Both ground and shield conductor terminal blocks have a contact foot in the bottom level, automatically establishing direct contact to the DIN-rail or busbar.

The flexible double-deck marker carrier, which is placed above the wiring level, can be pushed aside during wiring. The carrier has two staggered levels for WMB markers that perfectly align with the terminal block decks.

With a terminal block width of just 5.2 mm, an effective width of just 2.6 mm for terminal blocks of same or different potentials can be realized for conductors ranging 0.25 mm² ... 4 mm² (22 ... 12 AWG).

Shielded control cables are becoming an increasingly common solution to external signal interference.

Front-entry shield conductor terminal blocks are ideal for connecting braided cables. Like front-entry ground conductor terminal blocks, they are equipped with a grounding foot for direct electrical connection to the rail, however they differ significantly by their white insulated housing. Shield conductor terminal blocks for front-entry wiring can be directly mounted beside signal-conductor terminal blocks, providing excellent deflection of interfering signals.

Double-Deck Terminal Block TOPJOB® S; with End Plate; 800 V 2.5 (4) mm²; 2002 Series

1

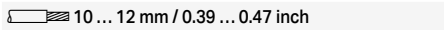
Technical Data	
0.25 ... 2.5 (4) mm ² ①	22 ... 12 AWG
800 V / 8 kV / 3 ②	600 V, 20 A ③
I _N 24 A	600 V, 20 A ④
Terminal block width: 6.2 mm / 0.244 inch	
 10 ... 12 mm / 0.39 ... 0.47 inch	

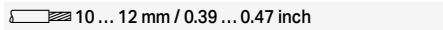
Technical Data	
0.25 ... 2.5 (4) mm ² ①	22 ... 12 AWG
800 V / 8 kV / 3 ②	600 V, 20 A ③
I _N 24 A	600 V, 20 A ④
Terminal block width: 6.2 mm / 0.244 inch	
 10 ... 12 mm / 0.39 ... 0.47 inch	

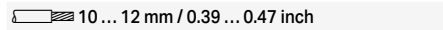
Technical Data	
0.25 ... 2.5 (4) mm ² ①	22 ... 12 AWG
800 V / 8 kV / 3 ②	600 V, 20 A ③
I _N 24 A	600 V, 20 A ④
Terminal block width: 6.2 mm / 0.244 inch	
 10 ... 12 mm / 0.39 ... 0.47 inch	

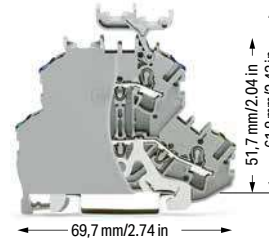
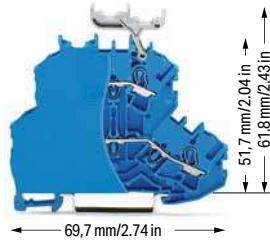
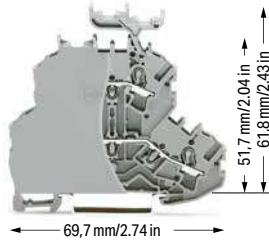

Double-deck terminal block; through/through terminal block; with end plate; with marker carrier; gray

	Item No.	Pack. Unit
○ L/L ⑤	2002-2231/099-000 ④	50
○ N/L ⑤	2002-2232/099-000 ④	50
○ L/N ⑤	2002-2233/099-000 ④	50

Double-deck terminal block; through/through terminal block; with end plate; with marker carrier; blue

	Item No.	Pack. Unit
● N/N ⑤	2002-2234/099-000 ④	50

Double-deck terminal block; ground conductor/through terminal block; with end plate; with marker carrier; gray

	Item No.	Pack. Unit
○ PE/N ⑤	2002-2247/099-000 ④	50
○ PE/L ⑤	2002-2257/099-000 ④	50

Double-deck terminal block; through/through terminal block; with end plate; without marker carrier; gray

○ L/L ⑤	2002-2201/099-000 ④	50
○ N/L ⑤	2002-2202/099-000 ④	50
○ L/N ⑤	2002-2203/099-000 ④	50

Double-deck terminal block; through/through terminal block; with end plate; without marker carrier; blue

● N/N ⑤	2002-2204/099-000 ④	50
---------	---------------------	----

Double-deck terminal block; ground conductor/through terminal block; with end plate; without marker carrier; gray

○ PE/N ⑤	2002-2217/099-000	50
○ PE/L ⑤	2002-2227/099-000	50

Other terminal blocks with the same profile:		
Diode	2002-2211/1000-410	Page 172
LED	2002-2221/1000-434	Page 172

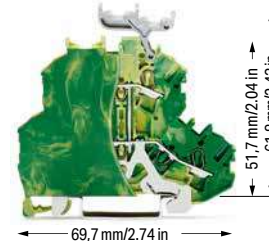
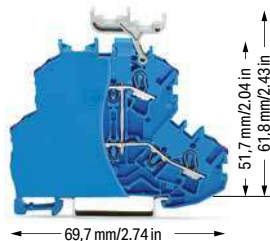
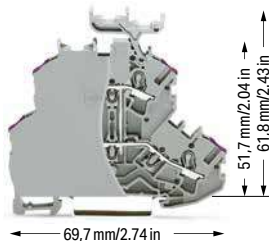

Double-deck terminal block; 4-conductor through terminal block; with end plate; with marker carrier; internally commoned; violet conductor entry; gray

	Item No.	Pack. Unit
○ L ⑤	2002-2238/099-000 ④	50

Double-deck terminal block; 4-conductor through terminal block; with end plate; with marker carrier; internally commoned; violet conductor entry; blue

	Item No.	Pack. Unit
● N ⑤	2002-2239/099-000 ④	50

Double-deck terminal block; 4-conductor ground terminal block; with end plate; with marker carrier; internally commoned; green-yellow

	Item No.	Pack. Unit
● PE ⑤	2002-2237/099-000 ④	50

Double-deck terminal block; 4-conductor through terminal block; with end plate; without marker carrier; internally commoned; violet conductor entry; gray

○ L ⑤	2002-2208/099-000 ④	50
-------	---------------------	----

Double-deck terminal block; 4-conductor through terminal block; with end plate; without marker carrier; internally commoned; violet conductor entry; blue

● N ⑤	2002-2209/099-000 ④	50
-------	---------------------	----

Double-deck terminal block; 4-conductor ground terminal block; with end plate; without marker carrier; internally commoned; green-yellow

● PE ⑤	2002-2207/099-000 ④	50
--------	---------------------	----

Technical Data

0.25 ... 2.5 (4) mm ² ①	22 ... 12 AWG
800 V / 8 kV / 3 ②	600 V, 20 A ③
I _N 24 A	600 V, 20 A ④
Terminal block width: 6.2 mm / 0.244 inch	
 10 ... 12 mm / 0.39 ... 0.47 inch	

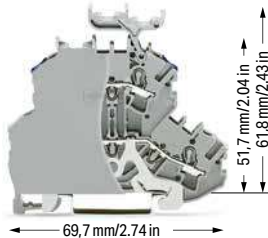

Double-deck terminal block; shield/through terminal block; with end plate; with marker carrier; gray

	Item No.	Pack. Unit
○ Shield/N	2002-2248/099-000	50
○ Shield/L	2002-2258/099-000	50

Double-deck terminal block; shield/through terminal block; with end plate; without marker carrier; gray

○ Shield/N	2002-2218/099-000	50
○ Shield/L	2002-2228/099-000	50

① Conductor range: 0.25 ... 4 mm² "s+f-st";
Push-in termination: 1 ... 4 mm² "s" and 1 ... 2.5 mm² "insulated ferrules, 12 mm"
Depending on the conductor characteristic, a conductor with a smaller cross section can also be inserted via push-in termination.

② 800 V = rated voltage
8 kV = rated impulse voltage
3 = pollution degree
(see Section 15)

③ Terminal blocks with a blue insulated housing are suitable for Ex i applications.

④ Terminal blocks with an Ex mark are suitable for Ex e II applications.
440 V; 20 A
18 A jumper
(see Section 15)

Please observe the application notes:
Jumpers, from page 185
Testing accessories, page 181
Marking, from page 684

A protective warning marker and an insulation stop must be applied individually. Due to the 6.2 mm width of double-deck terminal blocks with end plates, 2004 Series Push-In Type Jumper Bars must be used.

Approvals and corresponding ratings, visit www.wago.com

Accessories; 2002 Series

Appropriate marking systems:
WMB/Marking strips

End and intermediate plate; 0.8 mm thick

	orange	2002-2292	100 (25)
	gray	2002-2291	100 (25)

Insulation stop; 5 pcs/strip; 0.25 ... 0.5 mm²

	light gray	2002-171	200 (25)
---	------------	----------	----------

Insulation stop; 5 pcs/strip; 0.75 ... 1 mm²

	dark gray	2002-172	200 (25)
---	-----------	----------	----------

Push-in type jumper bar; insulated; I_N 32 A; light gray

	2-way	2004-402	25
	3-way	2004-403	25
	4-way	2004-404	25
	5-way	2004-405	25
	6-way	2004-406	25
	7-way	2004-407	25
	8-way	2004-408	25
	9-way	2004-409	25
	10-way	2004-410	25

Push-in type jumper bar; insulated; I_N 32 A; light gray

	1 to 3	2004-433	25
	1 to 4	2004-434	25
	1 to 5	2004-435	25
	1 to 6	2004-436	25
	1 to 7	2004-437	25
	1 to 8	2004-438	25
	1 to 9	2004-439	25
	1 to 10	2004-440	25

Double-deck vertical jumper; insulated; I_N 24 A

	light gray	2002-492	100 (25)
	orange	2002-492/000-012	100 (25)

Accessories; 2002 Series

Appropriate marking systems:
WMB/Marking strips

Test plug adapter; for 4 mm Ø test plug

	gray	2009-174	100 (25)
---	------	----------	----------

Testing tap; for max. 2.5 mm²

	gray	2009-182	100 (25)
---	------	----------	----------

Protective warning marker; with black high-voltage symbol; for 5 terminal blocks

	yellow	2002-115	100 (25)
---	--------	----------	----------

Marking strip; plain; 11 mm wide; 50 m reel

	white	2009-110	1
---	-------	----------	---

WMB marking card; white; 10 strips with 10 markers/card; 5 ... 5.2 mm stretchable

	plain	793-5501	5
---	-------	----------	---

Double-deck marker carrier; pivoting

	gray	2002-121	50 (25)
--	------	----------	---------

Double-Deck Terminal Block TOPJOB® S

2.5 (4) mm²; 2002 Series

1

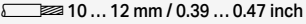
Technical Data	
0.25 ... 2.5 (4) mm ² ①	22 ... 12 AWG
1000 VAC/DC / 1500 VDC / 12 kV / 3 ②	
I _N 24 A	1000 V, 20 A ③
Terminal block width: 7.2 mm / 0.283 inch	
 10 ... 12 mm / 0.39 ... 0.47 inch	

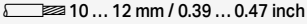
Technical Data	
0.25 ... 2.5 (4) mm ² ①	22 ... 12 AWG
1000 VAC/DC / 1500 VDC / 12 kV / 3 ②	
I _N 24 A	1000 V, 20 A ③
Terminal block width: 7.2 mm / 0.283 inch	
 10 ... 12 mm / 0.39 ... 0.47 inch	

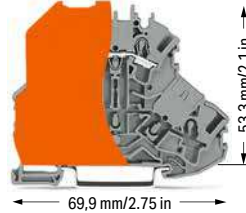
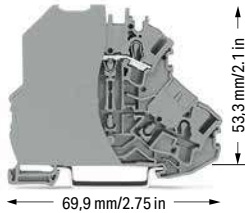

Double-deck terminal block; contact insert only on upper deck; gray separator plate; oversized; gray

Double-deck terminal block; contact insert only on upper deck; orange separator plate; oversized; gray

	Item No.	Pack. Unit
○ L	2002-2201/097-000	50

	Item No.	Pack. Unit
○ L	2002-2201/098-000	50

Accessories; 2002 Series

Appropriate marking systems: WMB/Marking strips

Insulation stop; 5 pcs/strip; 0.25 ... 0.5 mm²

	light gray	2002-171	200 (25)
--	------------	----------	----------

Insulation stop; 5 pcs/strip; 0.75 ... 1 mm²

	dark gray	2002-172	200 (25)
---	-----------	----------	----------

Protective warning marker; with black high-voltage symbol; for 5 terminal blocks

	yellow	2002-115	100 (25)
---	--------	----------	----------

Test plug adapter; for 4 mm Ø test plug

	gray	2009-174	100 (25)
---	------	----------	----------

Testing tap; for max. 2.5 mm²

	gray	2009-182	100 (25)
---	------	----------	----------

Marking strip; plain; 11 mm wide; 50 m reel

	white	2009-110	1
---	-------	----------	---

WMB marking card; white; 10 strips with 10 markers/card; 5 ... 5.2 mm stretchable

	plain	793-5501	5
---	-------	----------	---

Double-deck marker carrier; pivoting

	gray	2002-121	50 (25)
---	------	----------	---------

① Conductor range: 0.25 ... 4 mm² "s+f-st"; Push-in termination: 1 ... 4 mm² "s" and 1 ... 2.5 mm² "insulated ferrules, 12 mm" Depending on the conductor characteristic, a conductor with a smaller cross section can also be inserted via push-in termination.

② 1000 VAC/DC = rated voltage
1500 VDC
12 kV = rated impulse voltage
3 = pollution degree (see Section 15)

Please observe the application notes:
Testing accessories, page 181
Marking, from page 684

A protective warning marker and an insulation stop must be applied individually.

Approvals and corresponding ratings, visit www.wago.com

Double-Deck Terminal Block TOPJOB® S; with Vertical Conductor Entry 2.5 (4) mm²; 2002 Series

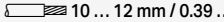
Technical Data	
0.25 ... 2.5 (4) mm ² ①	22 ... 12 AWG
800 V / 8 kV / 3 ②	600 V, 20 A ③
I _N 24 A (28 A)	600 V, 24 A ④
Terminal block width: 5.2 mm / 0.205 inch	
 10 ... 12 mm / 0.39 ... 0.47 inch	

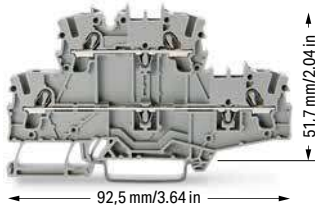

Double-deck terminal block; through/through terminal block; with vertical conductor entry; without marker carrier; gray

	Item No.	Pack. Unit
<input type="radio"/> L/L ⑤	2002-2701 ④	50
<input type="radio"/> N/L ⑤	2002-2702 ④	50
<input type="radio"/> L/N ⑤	2002-2703 ④	50

Double-deck terminal block; through/through terminal block; with vertical conductor entry; without marker carrier; blue

<input checked="" type="radio"/> N/N ⑤	2002-2704 ④ ④	50
--	---------------	----

Double-deck terminal block; through/through terminal block; with vertical conductor entry; with marker carrier; gray

<input type="radio"/> L/L ⑤	2002-2731 ④	50
-----------------------------	-------------	----

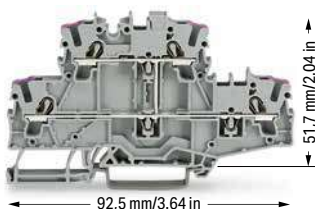

Double-deck terminal block; 4-conductor through terminal block; with vertical conductor entry; without marker carrier; internally commoned; violet conductor entry; gray

	Item No.	Pack. Unit
<input type="radio"/> L ⑤	2002-2708 ④	50

Double-deck terminal block; 4-conductor through terminal block; with vertical conductor entry; without marker carrier; internally commoned; violet conductor entry; blue

<input checked="" type="radio"/> N ⑤	2002-2709 ④ ④	50
--------------------------------------	---------------	----

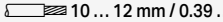
Technical Data	
0.25 ... 2.5 (4) mm ² ①	22 ... 12 AWG
800 V / 8 kV / 3 ②	600 V, 20 A ③
I _N 24 A (28 A)	600 V, 24 A ④
Terminal block width: 5.2 mm / 0.205 inch	
 10 ... 12 mm / 0.39 ... 0.47 inch	

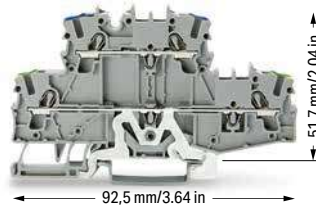

Double-deck terminal block; ground conductor/through terminal block; with vertical conductor entry; without marker carrier; gray

	Item No.	Pack. Unit
<input type="radio"/> PE/N ⑤	2002-2717 ④	50
<input type="radio"/> PE/L ⑤	2002-2727 ④	50



Double-deck terminal block; 4-conductor ground terminal block; with vertical conductor entry; without marker carrier; internally commoned; green-yellow

	Item No.	Pack. Unit
<input checked="" type="radio"/> PE	2002-2707	50
<input checked="" type="radio"/> PE ⑤	2002-2707/999-950 ④	50

① Conductor range: 0.25 ... 4 mm² "s+f-st"; Push-in termination: 1 ... 4 mm² "s" and 1 ... 2.5 mm² "insulated ferrules, 12 mm"
Depending on the conductor characteristic, a conductor with a smaller cross section can also be inserted via push-in termination.

② 800 V = rated voltage
8 kV = rated impulse voltage
3 = pollution degree
(see Section 15)

③ Terminal blocks with a blue housing are suitable for Ex i applications.

④ Terminal blocks with an Ex mark are suitable for Ex e II applications.
550 V; 21 A
17 A jumper and 16 A staggered jumper
(see Section 15)

Please observe the application notes:
Jumpers, from page 182
Testing accessories, page 181
Marking, from page 684

Approvals and corresponding ratings, visit www.wago.com

Accessories; 2002 Series

Appropriate marking systems:
WMB/WMB Inline/Marking strips

End and intermediate plate; 0.8 mm thick

	orange	2002-2792	100 (25)
	gray	2002-2791	100 (25)

Ex e/Ex i separator; orange; 3 mm thick

	125.5 mm	209-192	50 (25)
---	----------	---------	---------

Insulation stop; 5 pcs/strip; 0.25 ... 0.5 mm²

	light gray	2002-171	200 (25)
---	------------	----------	----------

Insulation stop; 5 pcs/strip; 0.75 ... 1 mm²

	dark gray	2002-172	200 (25)
---	-----------	----------	----------

Push-in type jumper bar; insulated; I_N 25 A; light gray

	2-way	2002-402	25
	3-way	2002-403	25
	4-way	2002-404	25
	5-way	2002-405	25
	6-way	2002-406	25
	7-way	2002-407	25
	8-way	2002-408	25
	9-way	2002-409	25
	10-way	2002-410	25

Push-in type jumper bar; insulated; I_N 25 A; light gray

	1 to 3	2002-433	25
	1 to 4	2002-434	25
	1 to 5	2002-435	25
	1 to 6	2002-436	25
	1 to 7	2002-437	25
	1 to 8	2002-438	25
	1 to 9	2002-439	25
	1 to 10	2002-440	25

Double-deck vertical jumper; insulated; I_N 24 A

	light gray	2002-492	100 (25)
	orange	2002-492/000-012	100 (25)

Double-deck marker carrier; pivoting

	gray	2002-121	50 (25)
---	------	----------	---------

4-Conductor Double-Deck Terminal Block TOPJOB® S

2.5 (4) mm²; 2002 Series

1

Technical Data

0.25 ... 2.5 (4) mm ² ①	22 ... 12 AWG
800 V / 8 kV / 3 ②	600 V, 20 A ③
I _N 24 A (28 A)	600 V, 20 A ④

Terminal block width: 5.2 mm / 0.205 inch

10 ... 12 mm / 0.39 ... 0.47 inch

Technical Data

0.25 ... 2.5 (4) mm ² ①	22 ... 12 AWG
800 V / 8 kV / 3 ②	600 V, 20 A ③
I _N 24 A (28 A)	600 V, 20 A ④

Terminal block width: 5.2 mm / 0.205 inch

10 ... 12 mm / 0.39 ... 0.47 inch

Technical Data

0.25 ... 2.5 (4) mm ² ①	22 ... 12 AWG
800 V / 8 kV / 3 ②	600 V, 20 A ③
I _N 24 A (28 A)	600 V, 20 A ④

Terminal block width: 5.2 mm / 0.205 inch

10 ... 12 mm / 0.39 ... 0.47 inch

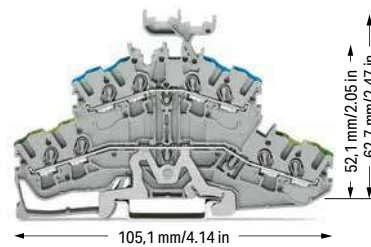
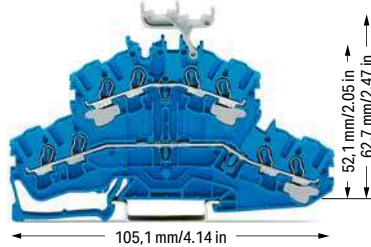
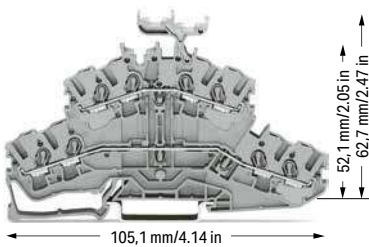

4-conductor double-deck terminal block; through/through terminal block; with marker carrier; gray

	Item No.	Pack. Unit
○ L/L ⑤	2002-2431 ④	50
○ N/L ⑤	2002-2432 ④	50
○ L/N ⑤	2002-2433 ④	50

4-conductor double-deck terminal block; through/through terminal block; with marker carrier; blue

	Item No.	Pack. Unit
● N/N ⑤	2002-2434 ③ ④	50

4-conductor double-deck terminal block; ground conductor/through terminal block; with marker carrier; gray

	Item No.	Pack. Unit
○ PE/N ⑤	2002-2447 ④	50
○ PE/L ⑤	2002-2457 ④	50

4-conductor double-deck terminal block; through/through terminal block; without marker carrier; gray

○ L/L ⑤	2002-2401 ④	50
○ N/L ⑤	2002-2402 ④	50
○ L/N ⑤	2002-2403 ④	50

4-conductor double-deck terminal block; through/through terminal block; without marker carrier; blue

● N/N ⑤	2002-2404 ③ ④	50
---------	---------------	----

4-conductor double-deck terminal block; ground conductor/through terminal block; without marker carrier; gray

○ PE/N ⑤	2002-2417 ④	50
○ PE/L ⑤	2002-2427 ④	50

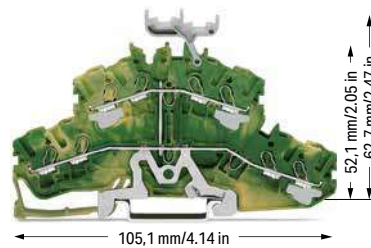
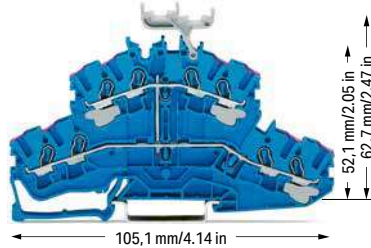
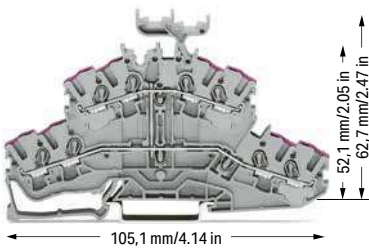

4-conductor double-deck terminal block; 8-conductor through terminal block; with marker carrier; internally commoned; violet conductor entry; gray

	Item No.	Pack. Unit
○ L ⑤	2002-2438 ④	50

4-conductor double-deck terminal block; 8-conductor through terminal block; with marker carrier; internally commoned; violet conductor entry; blue

	Item No.	Pack. Unit
● N ⑤	2002-2439 ③ ④	50

4-conductor double-deck terminal block; 8-conductor ground terminal block; with marker carrier; internally commoned; green-yellow

	Item No.	Pack. Unit
● PE ⑤	2002-2437 ④	50

4-conductor double-deck terminal block; 8-conductor through terminal block; without marker carrier; internally commoned; violet conductor entry; gray

○ L ⑤	2002-2408 ④	50
-------	-------------	----

4-conductor double-deck terminal block; 8-conductor through terminal block; without marker carrier; internally commoned; violet conductor entry; blue

● N ⑤	2002-2409 ③ ④	50
-------	---------------	----

4-conductor double-deck terminal block; 8-conductor ground terminal block; without marker carrier; internally commoned; green-yellow

● PE ⑤	2002-2407 ④	50
--------	-------------	----

Technical Data

0.25 ... 2.5 (4) mm² ① | 22 ... 12 AWG

800 V / 8 kV / 3 ② | 600 V, 20 A ③

I_N 24 A (28 A) | 600 V, 20 A ④

Terminal block width: 5.2 mm / 0.205 inch

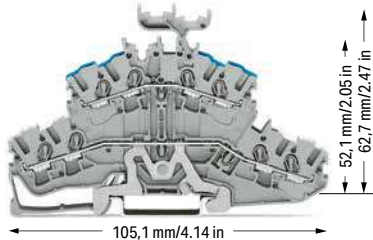
 10 ... 12 mm / 0.39 ... 0.47 inch

4-conductor double-deck terminal block; shield/through terminal block; with marker carrier; gray

	Item No.	Pack. Unit
○ Shield/N	2002-2448	50
○ Shield/L	2002-2458	50

4-conductor double-deck terminal block; shield/through terminal block; without marker carrier; gray

	Item No.	Pack. Unit
○ Shield/N	2002-2418	50
○ Shield/L	2002-2428	50

① Conductor range: 0.25 ... 4 mm² "s+f-st";
Push-in termination: 1 ... 4 mm² "s" and 1 ... 2.5 mm² "insulated ferrules, 12 mm"
Depending on the conductor characteristic, a conductor with a smaller cross section can also be inserted via push-in termination.

② 800 V = rated voltage
8 kV = rated impulse voltage
3 = pollution degree
(see Section 15)

③ Terminal blocks with a blue insulated housing are suitable for Ex i applications.

④ Terminal blocks with an Ex mark are suitable for Ex e II applications.
550 V; 21 A
17 A jumper and 16 A staggered jumper
(see Section 15)



Please observe the application notes:
Jumpers, from page 182
Testing accessories, page 181
Marking, from page 684

Approvals and corresponding ratings,
visit www.wago.com

Accessories; 2002 Series

Appropriate marking systems:
WMB/WMB Inline/Marking strips

End and intermediate plate; 0.8 mm thick

	orange	2002-2492	100 (25)
	gray	2002-2491	100 (25)

Ex e/Ex i separator; orange; 3 mm thick

	125.5 mm	209-192	50 (25)
---	----------	---------	---------

Insulation stop; 5 pcs/strip; 0.25 ... 0.5 mm²

	light gray	2002-171	200 (25)
---	------------	----------	----------

Insulation stop; 5 pcs/strip; 0.75 ... 1 mm²

	dark gray	2002-172	200 (25)
---	-----------	----------	----------

Push-in type jumper bar; insulated; I_N 25 A; light gray

	2-way	2002-402	25
	3-way	2002-403	25
	4-way	2002-404	25
	5-way	2002-405	25
	6-way	2002-406	25
	7-way	2002-407	25
	8-way	2002-408	25
	9-way	2002-409	25
	10-way	2002-410	25

Push-in type jumper bar; insulated; I_N 25 A; light gray

	1 to 3	2002-433	25
	1 to 4	2002-434	25
	1 to 5	2002-435	25
	1 to 6	2002-436	25
	1 to 7	2002-437	25
	1 to 8	2002-438	25
	1 to 9	2002-439	25
	1 to 10	2002-440	25

Double-deck vertical jumper; insulated; I_N 24 A

	light gray	2002-492	100 (25)
	orange	2002-492/000-012	100 (25)

Accessories; 2002 Series

Appropriate marking systems:
WMB/WMB Inline/Marking strips

Protective warning marker; with black high-voltage symbol; for 5 terminal blocks

	yellow	2002-115	100 (25)
---	--------	----------	----------

Test plug adapter; for 4 mm Ø test plug

	gray	2009-174	100 (25)
---	------	----------	----------

Testing tap; for max. 2.5 mm²

	gray	2009-182	100 (25)
---	------	----------	----------

Marking strip; plain; 11 mm wide; 50 m reel

	white	2009-110	1
---	-------	----------	---

WMB Inline, plain; 1,500 WMB markers (5 mm)/reel; 5 ... 5.2 mm stretchable

	white	2009-115	1
---	-------	----------	---

WMB marking card; white; 10 strips with 10 markers/card; 5 ... 5.2 mm stretchable

	plain	793-5501	5
--	-------	----------	---

Double-deck marker carrier; pivoting

	gray	2002-121	50 (25)
---	------	----------	---------

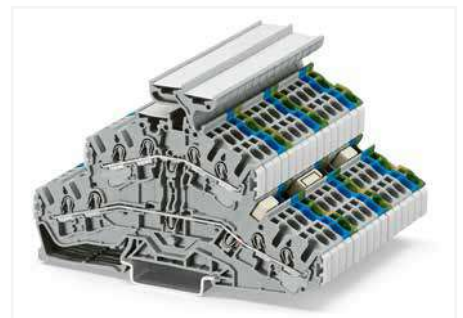

Double-deck terminal block assembly

Double-Deck Terminal Block TOPJOB® S

2.5 (4) mm²; 2002 Series

1

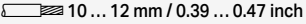
Technical Data	
0.25 ... 2.5 (4) mm ² ①	22 ... 12 AWG
500 V / 6 kV / 3 ②	300 V, 20 A ③
I _N 24 A (28 A)	300 V, 20 A ④
Terminal block width: 5.2 mm / 0.205 inch	
 10 ... 12 mm / 0.39 ... 0.47 inch	

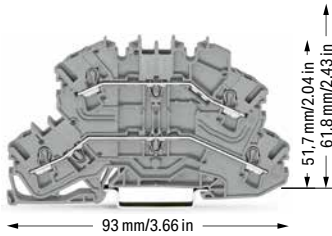

Double-deck terminal block; through/through terminal block; same profile as double-deck disconnect terminal block; without marker carrier; gray

	Item No.	Pack. Unit
○ L/L ⑤	2002-2601 ④	50
○ N/L ⑥	2002-2602 ④	50
○ L/N ⑦	2002-2603 ④	50

Other terminal blocks with the same profile:		
Carrier	2002-2661	Page 86
Disconnect	2002-2671	Page 86
Fuse	2002-2611	Page 87

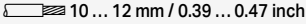
Technical Data	
0.25 ... 2.5 (4) mm ² ①	22 ... 12 AWG
500 V / 6 kV / 3 ②	300 V, 20 A ③
I _N 24 A (28 A)	300 V, 20 A ④
Terminal block width: 5.2 mm / 0.205 inch	
 10 ... 12 mm / 0.39 ... 0.47 inch	

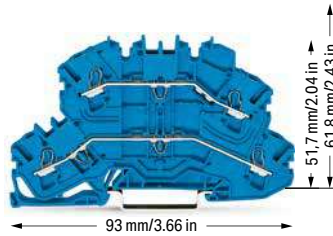

Double-deck terminal block; through/through terminal block; same profile as double-deck disconnect terminal block; without marker carrier; blue

	Item No.	Pack. Unit
● N/N ⑧	2002-2604 ③ ④	50

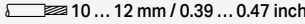
Technical Data	
0.25 ... 2.5 (4) mm ² ①	22 ... 12 AWG
500 V / 6 kV / 3 ②	300 V, 20 A ③
I _N 24 A (28 A)	300 V, 20 A ④
Terminal block width: 5.2 mm / 0.205 inch	
 10 ... 12 mm / 0.39 ... 0.47 inch	

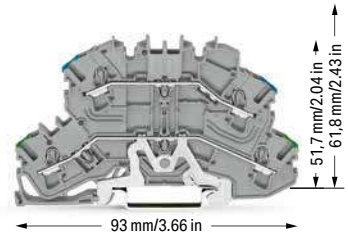

Double-deck terminal block; ground conductor/through terminal block; same profile as double-deck disconnect terminal block; without marker carrier; gray

	Item No.	Pack. Unit
○ PE/N ⑨	2002-2647 ④	50
○ PE/L ⑩	2002-2657 ④	50

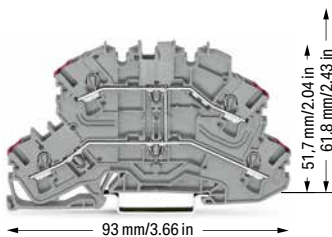

Double-deck terminal block; 4-conductor through terminal block; same profile as double-deck disconnect terminal block; without marker carrier; internally commoned; violet conductor entry; gray

	Item No.	Pack. Unit
○ L ⑪	2002-2608 ④	50

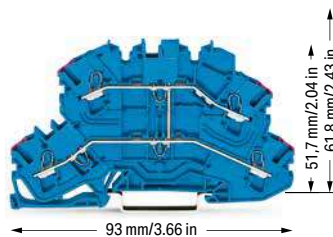

Double-deck terminal block; 4-conductor through terminal block; same profile as double-deck disconnect terminal block; without marker carrier; internally commoned; violet conductor entry; blue

	Item No.	Pack. Unit
● N ⑫	2002-2609 ③ ④	50

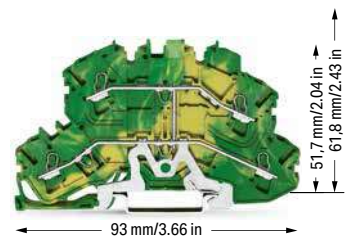

Double-deck terminal block; 4-conductor ground terminal block; same profile as double-deck disconnect terminal block; without marker carrier; internally commoned; green-yellow

	Item No.	Pack. Unit
● PE ⑬	2002-2607 ④	50

❶ Conductor range: 0.25 ... 4 mm² "s+f-st";
Push-in termination: 1 ... 4 mm² "s" and 1 ... 2.5 mm²
"insulated ferrules, 12 mm"
Depending on the conductor characteristic, a conductor with a smaller cross section can also be inserted via push-in termination.

❷ 500 V = rated voltage
6 kV = rated impulse voltage
3 = pollution degree
(see Section 15)

❸ Terminal blocks with a blue insulated housing are suitable for Ex i applications.

❹ Terminal blocks with an Ex mark are suitable for Ex e II applications.
440 V; 14 A
(see Section 15)

Please observe the application notes:
Jumpers, from page 182
Testing accessories, page 181
Marking, from page 684

Approvals and corresponding ratings,
visit www.wago.com

Accessories; 2002 Series

Appropriate marking systems:
WMB/WMB Inline/Marking strips

End and intermediate plate; 1 mm thick

	orange	2002-2692	100 (25)
	gray	2002-2691	100 (25)

Ex e/Ex i separator; orange; 3 mm thick

	125.5 mm	209-192	50 (25)
---	----------	---------	---------

Insulation stop; 5 pcs/strip; 0.25 ... 0.5 mm²

	light gray	2002-171	200 (25)
---	------------	----------	----------

Insulation stop; 5 pcs/strip; 0.75 ... 1 mm²

	dark gray	2002-172	200 (25)
---	-----------	----------	----------

Push-in type jumper bar; insulated; I_N 25 A; light gray

	2-way	2002-402	25
	3-way	2002-403	25
	4-way	2002-404	25
	5-way	2002-405	25
	6-way	2002-406	25
	7-way	2002-407	25
	8-way	2002-408	25
	9-way	2002-409	25
	10-way	2002-410	25

Push-in type jumper bar; insulated; I_N 25 A; light gray

	1 to 3	2002-433	25
	1 to 4	2002-434	25
	1 to 5	2002-435	25
	1 to 6	2002-436	25
	1 to 7	2002-437	25
	1 to 8	2002-438	25
	1 to 9	2002-439	25
	1 to 10	2002-440	25

Double-deck vertical jumper; insulated; I_N 24 A

	light gray	2002-492	100 (25)
	orange	2002-492/000-012	100 (25)

Double-deck marker carrier; pivoting

	gray	2002-121	50 (25)
---	------	----------	---------

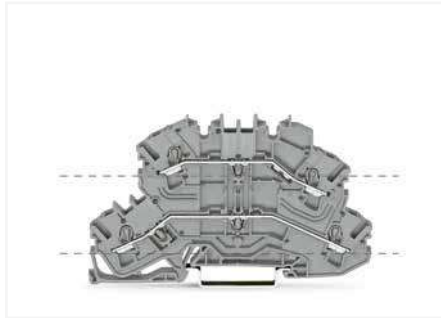

Through terminal blocks (2002-2601) feature two independent current bars on both lower and upper deck, sharing the same profile as disconnect terminal blocks. These terminal blocks can be commoned via double-deck vertical jumpers (2002-492).

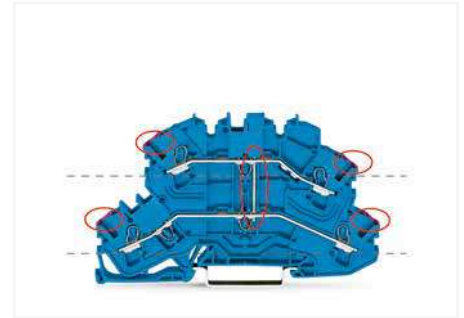

4-conductor through terminal blocks (2002-2609) with internal commoning can be immediately identified via violet conductor entry.



Double-deck disconnect terminal blocks with a pivoting knife disconnect (2002-2671) can be used as through terminal blocks on the lower deck and as disconnect terminal blocks on the upper deck. Besides disconnection and measurement, double-deck carrier terminal blocks (2002-2667) also provide ground conductor functionality.

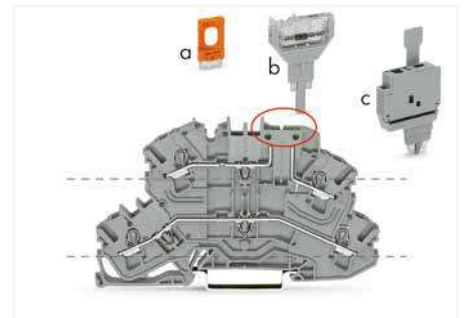

Carrier terminal blocks (2002-2661) have the same design as disconnect terminal blocks. The following components may be used:
- Disconnect plugs (a: 2002-401)
- Pluggable diode (b: 2002-800/1000-411)
- LED module (2002-800/1000-541, no illustration)
- Fuse plug (c: 2004-911)



Double-deck fuse disconnect terminal blocks with a pivoting fuse holder (2002-2611, gray) are compatible with disconnect, carrier, through and ground conductor terminal blocks. The fuse holder is also available with a blown fuse LED indicator (e.g., 2002-2611/1000-541 for 12-30 V).



An end plate for fuse disconnect terminal blocks (shown in orange, 2002-1092) is used for additional protection, preventing the fuse holder from being opened. The fuse cannot be replaced until disconnecting the fuse holder from the power supply.

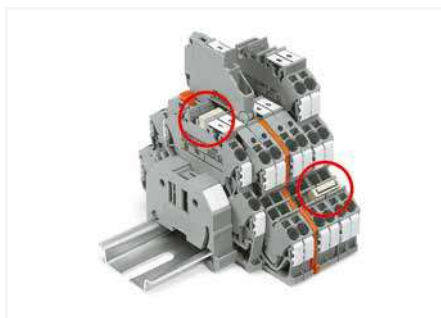

The same profile allows for commoning with double-deck terminal blocks (upper deck) and with triple-deck terminal blocks (lower deck).

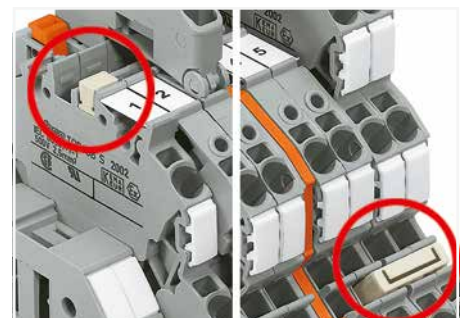

Left picture – Vertical jumper (2002-492)
Right picture – Push-in type jumper bar (2002 Series)

Double-Deck Disconnect Terminal Block, Double-Deck Carrier Terminal Block TOPJOB® S 2.5 (4) mm²; 2002 Series

1

Technical Data	
0.25 ... 2.5 (4) mm ² ①	22 ... 12 AWG
400 V / 6 kV / 3 ②	300 V, 15 A ③
I _N 16 A	300 V, 15 A ④
Terminal block width: 5.2 mm / 0.205 inch	
 10 ... 12 mm / 0.39 ... 0.47 inch	

Technical Data	
0.25 ... 2.5 (4) mm ² ①	22 ... 12 AWG
400 V / 6 kV / 3 ②	300 V, 15 A ③
I _N 16 A	300 V, 15 A ④
Terminal block width: 5.2 mm / 0.205 inch	
 10 ... 12 mm / 0.39 ... 0.47 inch	

- ① Conductor range: 0.25 ... 4 mm² "s+f-st"; Push-in termination: 1 ... 4 mm² "s" and 1 ... 2.5 mm² "insulated ferrules, 12 mm"
Depending on the conductor characteristic, a conductor with a smaller cross section can also be inserted via push-in termination.
 - ② 400 V = rated voltage
6 kV = rated impulse voltage
3 = pollution degree (see Section 15)
 - ③ Terminal blocks with an Ex mark are suitable for Ex e II applications.
440 V; 14 A (see Section 15)
- Please observe the application notes:
Jumpers, from page 182
Testing accessories, page 181
Marking, from page 684

Approvals and corresponding ratings, visit www.wago.com

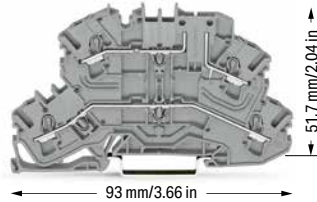
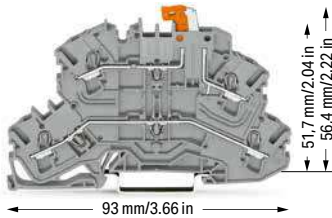

Double-deck disconnect terminal block; with a pivoting knife disconnect; gray

	Item No.	Pack. Unit
○ L/L ⑤	2002-2671 ③	50
○ N/L ⑤	2002-2672 ③	50

Double-deck carrier terminal block; upper-deck base; gray

	Item No.	Pack. Unit
○ L/L ⑤	2002-2661 ③	50
○ N/L ⑤	2002-2662 ③	50



Other terminal blocks with the same profile:

Through	2002-2601	Page 84
Fuse	2002-2611	Page 87

Accessories; 2002 Series

Appropriate marking systems:
WMB/WMB Inline/Marking strips

End and intermediate plate; 1 mm thick

	orange	2002-2692	100 (25)
	gray	2002-2691	100 (25)

Ex e/Ex i separator; orange; 3 mm thick

	125.5 mm	209-192	50 (25)
---	----------	---------	---------

Insulation stop; 5 pcs/strip; 0.25 ... 0.5 mm²

	light gray	2002-171	200 (25)
---	------------	----------	----------

Insulation stop; 5 pcs/strip; 0.75 ... 1 mm²

	dark gray	2002-172	200 (25)
---	-----------	----------	----------

Push-in type jumper bar; insulated; I_N 25 A; light gray

	2-way	2002-402	25
	3-way	2002-403	25
	4-way	2002-404	25
	5-way	2002-405	25
	6-way	2002-406	25
	7-way	2002-407	25
	8-way	2002-408	25
	9-way	2002-409	25
	10-way	2002-410	25

Push-in type jumper bar; insulated; I_N 25 A; light gray

	1 to 3	2002-433	25
	1 to 4	2002-434	25
	1 to 5	2002-435	25
	1 to 6	2002-436	25
	1 to 7	2002-437	25
	1 to 8	2002-438	25
	1 to 9	2002-439	25
	1 to 10	2002-440	25

Double-deck vertical jumper; insulated; I_N 24 A

	light gray	2002-492	100 (25)
	orange	2002-492/000-012	100 (25)

Double-deck marker carrier; pivoting

	gray	2002-121	50 (25)
---	------	----------	---------

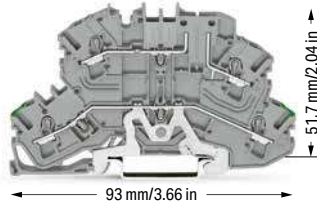
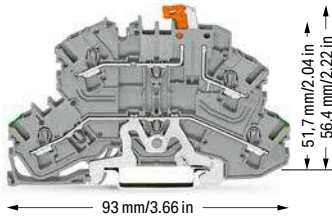

Double-deck disconnect terminal block; with a pivoting knife disconnect; gray

	Item No.	Pack. Unit
○ Shield/L	2002-2678 ③	50

Double-deck carrier terminal block; upper-deck base; gray

	Item No.	Pack. Unit
○ PE/L ⑤	2002-2667 ③	50

Double-Deck Fuse Terminal Block TOPJOB® S

2.5 (4) mm²; 2002 Series

Technical Data

0.25 ... 2.5 (4) mm ² ①	22 ... 12 AWG
250 V / 6 kV / 3 ②	300 V, 6.3 A ^N
I _N 6.3 A	300 V, 6.3 A [®]
Terminal block width: 6.2 mm / 0.244 inch	
 10 ... 12 mm / 0.39 ... 0.47 inch	

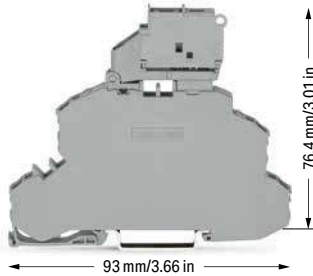

Double-deck fuse disconnect terminal block with a pivoting fuse holder; through/fuse terminal block; for 5 x 20 mm glass cartridge fuse; without blown fuse indication; gray
Electrical ratings are given by the fuse.

	Item No.	Pack. Unit
○ L/L ③	2002-2611 ③	25
○ N/L ③	2002-2612 ③	25

Other terminal blocks with the same profile:

Through	2002-2601	Page 84
---------	-----------	---------

Accessories; 2002 Series

Appropriate marking systems: WMB/Marking strips

End and intermediate plate; 1 mm thick

	orange	2002-2692	100 (25)
	gray	2002-2691	100 (25)

End plate for fuse terminal blocks; 2 mm thick

	orange	2002-1092	100 (25)
	gray	2002-1091	100 (25)

Push-in type jumper bar; insulated; I_N 32 A; light gray

	2-way	2004-402	25
	3-way	2004-403	25
	4-way	2004-404	25
	5-way	2004-405	25
	6-way	2004-406	25
	7-way	2004-407	25
	8-way	2004-408	25
	9-way	2004-409	25
	10-way	2004-410	25

Push-in type jumper bar; insulated; I_N 32 A; light gray

	1 to 3	2004-433	25
	1 to 4	2004-434	25
	1 to 5	2004-435	25
	1 to 6	2004-436	25
	1 to 7	2004-437	25
	1 to 8	2004-438	25
	1 to 9	2004-439	25
	1 to 10	2004-440	25

Double-deck vertical jumper; insulated; I_N 24 A

	light gray	2002-492	100 (25)
	orange	2002-492/000-012	100 (25)

Technical Data

0.25 ... 2.5 (4) mm ² ①	22 ... 12 AWG
250 V / 6 kV / 3 ②	30 V, 6.3 A ^N
I _N 6.3 A	30 V, 6.3 A [®]
Terminal block width: 6.2 mm / 0.244 inch	
 10 ... 12 mm / 0.39 ... 0.47 inch	

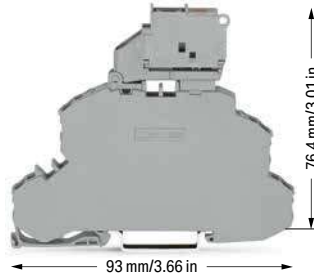

Double-deck fuse disconnect terminal block with a pivoting fuse holder; through/fuse terminal block; for 5 x 20 mm glass cartridge fuse; with blown fuse indication by LED; gray
Electrical ratings are given by the fuse and blown fuse indication. Leakage current in case of a blown fuse: LED 2 mA

	Item No.	Pack. Unit
○ 12 ... 30 V ③	2002-2611/1000-541 ③ ④	25
○ 30 ... 65 V ③	2002-2611/1000-542 ③ ⑤	25
○ 230 V ③	2002-2611/1000-836 ③	25
○ 120 V ③	2002-2611/1000-867 ③	25

① Conductor range: 0.25 ... 4 mm² "s+f-st"; Push-in termination: 1 ... 4 mm² "s" and 1 ... 2.5 mm² "insulated ferrules, 12 mm"
Depending on the conductor characteristic, a conductor with a smaller cross section can also be inserted via push-in termination.

② 250 V = rated voltage
6 kV = rated impulse voltage
3 = pollution degree (see Section 15)

③ Terminal blocks with an Ex mark are suitable for Ex II applications.
275 V; 6.3 A (see Section 15)

④ 30 V / 0.8 kV / 3

⑤ 65 V / 1.5 kV / 3

Please observe the application notes:
Jumpers, from page 185
Marking, from page 684

A protective warning marker and an insulation stop must be applied individually. Due to the 6.2 mm width of double-deck terminal blocks with end plates, 2004 Series Push-In Type Jumper Bars must be used.

Approvals and corresponding ratings, visit www.wago.com

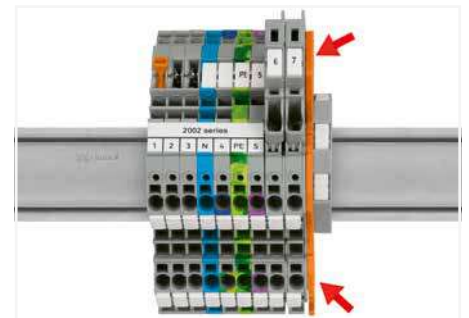

Additionally, an end plate for fuse terminal blocks (e.g., 2002-1092, orange) must be used at the end of an assembly or if there is no adjacent fuse terminal block.

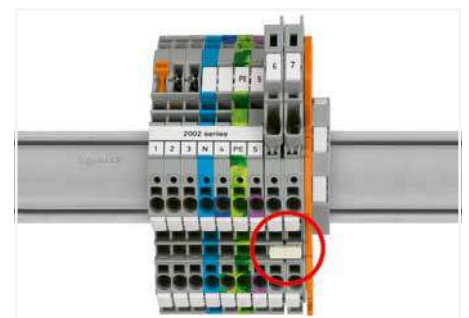

An intermediate plate is supplied with all 6.2 mm wide fused disconnect terminal blocks.
Due to the 6.2 mm width of fuse disconnect terminal blocks with a pivoting fuse holder, 2004 Series Push-In Type Jumper Bars must be used.

Triple-Deck Terminal Block TOPJOB® S; with Push-Button 2.5 (4) mm²; 2202 Series

1

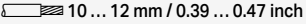
Technical Data	
0.25 ... 2.5 (4) mm ² ①	22 ... 12 AWG
500 V / 6 kV / 3 ②	
I _N 22 A (26 A)	
Terminal block width: 5.2 mm / 0.205 inch	
 10 ... 12 mm / 0.39 ... 0.47 inch	

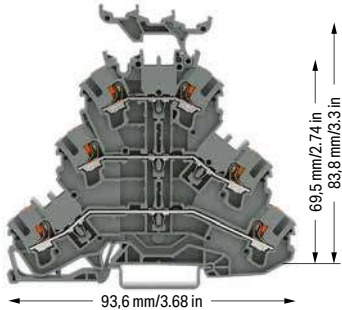

Triple-deck terminal block; with push-button; through/through/through terminal block; with marker carrier; gray

	Item No.	Pack. Unit
○ L/L/L	2202-3231 ④	50
○ L/L/N	2202-3233 ④	50

Triple-deck terminal block; with push-button; through/through/through terminal block; without marker carrier; gray

○ L/L/L	2202-3201 ④	50
○ L/L/N	2202-3203 ④	50

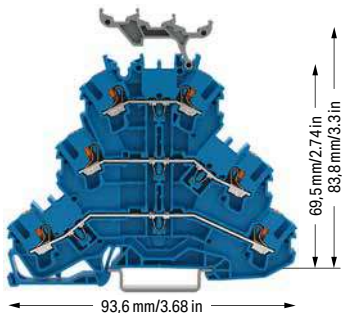

Triple-deck terminal block; with push-button; through/through/through terminal block; with marker carrier; blue

	Item No.	Pack. Unit
● N/N/N	2202-3234 ③ ④	50

Triple-deck terminal block; with push-button; through/through/through terminal block; without marker carrier; blue

● N/N/N	2202-3204 ③ ④	50
---------	---------------	----

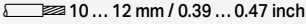
Technical Data	
0.25 ... 2.5 (4) mm ² ①	22 ... 12 AWG
500 V / 6 kV / 3 ②	
I _N 24 A (28 A) ③	
Terminal block width: 5.2 mm / 0.205 inch	
 10 ... 12 mm / 0.39 ... 0.47 inch	

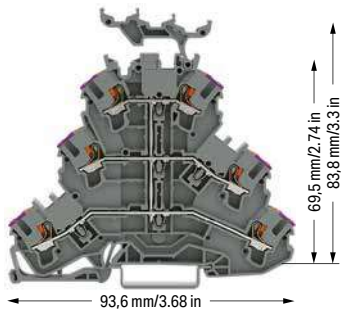

Triple-deck terminal block; with push-button; 6-conductor through terminal block; with marker carrier; internally commoned; violet conductor entry; gray

	Item No.	Pack. Unit
○ L	2202-3238 ④	50

Triple-deck terminal block; with push-button; 6-conductor through terminal block; without marker carrier; internally commoned; violet conductor entry; gray

○ L	2202-3208 ④	50
-----	-------------	----

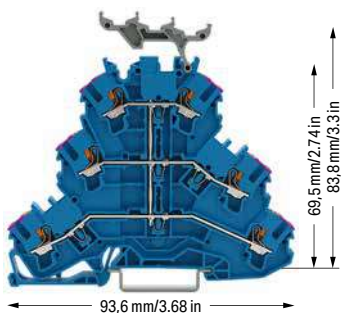

Triple-deck terminal block; with push-button; 6-conductor through terminal block; with marker carrier; internally commoned; violet conductor entry; blue

	Item No.	Pack. Unit
● N	2202-3239 ④	50

Triple-deck terminal block; with push-button; 6-conductor through terminal block; without marker carrier; internally commoned; violet conductor entry; blue

● N	2202-3209 ④	50
-----	-------------	----

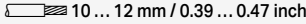
Technical Data	
0.25 ... 2.5 (4) mm ² ①	22 ... 12 AWG
500 V / 6 kV / 3 ②	
I _N 22 A (26 A)	
Terminal block width: 5.2 mm / 0.205 inch	
 10 ... 12 mm / 0.39 ... 0.47 inch	

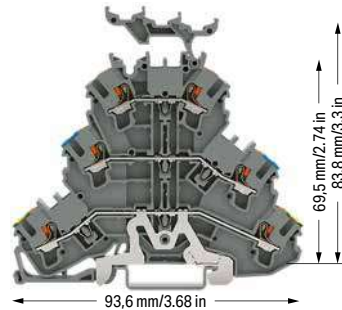

Triple-deck terminal block; with push-button; ground conductor/through/through terminal block; with marker carrier; gray

	Item No.	Pack. Unit
○ PE/N/L	2202-3247 ④	50
○ PE/L/L	2202-3257 ④	50

Triple-deck terminal block; with push-button; ground conductor/through/through terminal block; without marker carrier; gray

○ PE/N/L	2202-3217 ④	50
○ PE/L/L	2202-3227 ④	50

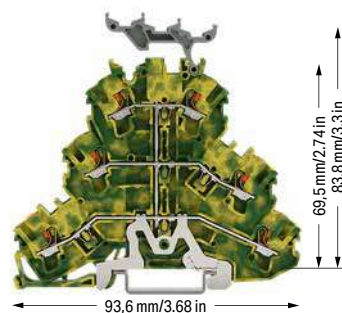

Triple-deck terminal block; with push-button; 6-conductor ground terminal block; with marker carrier; internally commoned; green-yellow

	Item No.	Pack. Unit
● PE	2202-3237 ④	50

Triple-deck terminal block; with push-button; 6-conductor ground terminal block; without marker carrier; internally commoned; green-yellow

● PE	2202-3207 ④	50
------	-------------	----

Technical Data

0.25 ... 2.5 (4) mm² ① | 22 ... 12 AWG

500 V / 6 kV / 3 ②

I_N 22 A (26 A)

Terminal block width: 5.2 mm / 0.205 inch

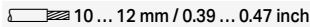
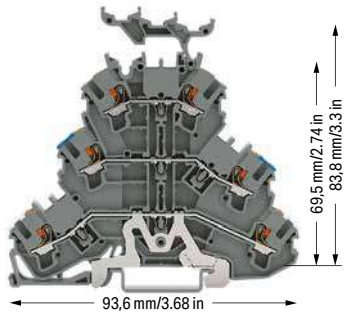
 10 ... 12 mm / 0.39 ... 0.47 inch

Triple-deck terminal block; with push-button; shield/through/through terminal block; with marker carrier; gray

	Item No.	Pack. Unit
○ Shield/N/L	2202-3248	50
○ Shield/L/L	2202-3258	50

Triple-deck terminal block; with push-button; shield/through/through terminal block; without marker carrier; gray

○ Shield/N/L	2202-3218	50
○ Shield/L/L	2202-3228	50

① Conductor range: 0.25 ... 4 mm² "s+f-st";
Push-in termination: 1 ... 4 mm² "s" and 1 ... 2.5 mm² "insulated ferrules, 12 mm"
Depending on the conductor characteristic, a conductor with a smaller cross section can also be inserted via push-in termination.

② 500 V = rated voltage
6 kV = rated impulse voltage
3 = pollution degree
(see Section 15)

③ Terminal blocks with a blue insulated housing are suitable for Ex i applications.

④ Terminal blocks with an Ex mark are suitable for Ex e II applications.
440 V, 19 A
17 A jumper
(see Section 15)

Please observe the application notes:

Jumpers, from page 182

Testing accessories, page 181

Marking, from page 684

Approvals and corresponding ratings, visit www.wago.com

Accessories; 2202 Series

Appropriate marking systems:
WMB/WMB Inline/Marking strips

End and intermediate plate; 0.8 mm thick

	orange	2002-3292	100 (25)
	gray	2002-3291	100 (25)

Insulation stop; 5 pcs/strip; 0.25 ... 0.5 mm²

	light gray	2002-171	200 (25)
---	------------	----------	----------

Insulation stop; 5 pcs/strip; 0.75 ... 1 mm²

	dark gray	2002-172	200 (25)
---	-----------	----------	----------

Push-in type jumper bar; insulated; I_N 25 A; light gray

	2-way	2002-402	25
	3-way	2002-403	25
	4-way	2002-404	25
	5-way	2002-405	25
	6-way	2002-406	25
	7-way	2002-407	25
	8-way	2002-408	25
	9-way	2002-409	25
	10-way	2002-410	25

Push-in type jumper bar; insulated; I_N 25 A; light gray

	1 to 3	2002-433	25
	1 to 4	2002-434	25
	1 to 5	2002-435	25
	1 to 6	2002-436	25
	1 to 7	2002-437	25
	1 to 8	2002-438	25
	1 to 9	2002-439	25
	1 to 10	2002-440	25

Double-deck vertical jumper; insulated; I_N 24 A

	light gray	2002-492	100 (25)
	orange	2002-492/000-012	100 (25)

Triple-deck vertical jumper; insulated; I_N 24 A

	light gray	2002-493	100 (25)
---	------------	----------	----------

Triple-deck marker carrier; pivoting

	gray	2002-131	50 (25)
---	------	----------	---------

Triple-Deck Terminal Block TOPJOB® S

2.5 (4) mm²; 2002 Series

1

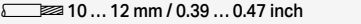
Technical Data	
0.25 ... 2.5 (4) mm ² ①	22 ... 12 AWG
500 V / 6 kV / 3 ②	300 V, 20 A ③
I _N 24 A (28 A)	600 V, 20 A ④
Terminal block width: 5.2 mm / 0.205 inch	
 10 ... 12 mm / 0.39 ... 0.47 inch	

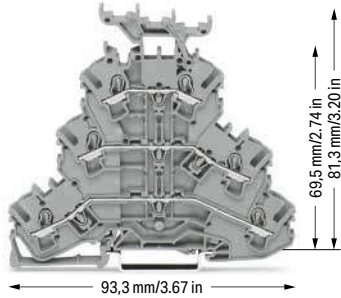

Triple-deck terminal block; through/through/through terminal block; with marker carrier; gray

	Item No.	Pack. Unit
○ L/L/L ⑤	2002-3231 ④	50
○ L/L/N ⑤	2002-3233 ④	50

Triple-deck terminal block; through/through/through terminal block; without marker carrier; gray		
○ L/L/L ⑤	2002-3201 ④	50
○ L/L/N ⑤	2002-3203 ④	50

Other terminal blocks with the same profile:		
Diode	2002-3211/1000-410	Page 174
LED	2002-3221/1000-434	Page 174

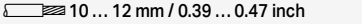
Technical Data	
0.25 ... 2.5 (4) mm ² ①	22 ... 12 AWG
500 V / 6 kV / 3 ②	300 V, 20 A ③
I _N 24 A (28 A)	600 V, 20 A ④
Terminal block width: 5.2 mm / 0.205 inch	
 10 ... 12 mm / 0.39 ... 0.47 inch	

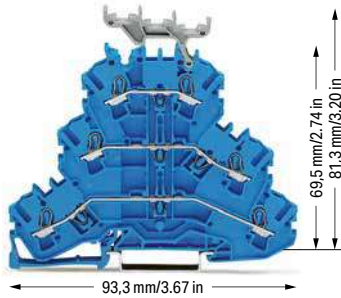

Triple-deck terminal block; through/through/through terminal block; with marker carrier; blue

	Item No.	Pack. Unit
● N/N/N ⑤	2002-3234 ③ ④	50

Triple-deck terminal block; through/through/through terminal block; without marker carrier; blue		
● N/N/N ⑤	2002-3204 ③ ④	50

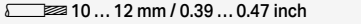
Technical Data	
0.25 ... 2.5 (4) mm ² ①	22 ... 12 AWG
500 V / 6 kV / 3 ②	300 V, 20 A ③
I _N 24 A (28 A)	600 V, 20 A ④
Terminal block width: 5.2 mm / 0.205 inch	
 10 ... 12 mm / 0.39 ... 0.47 inch	

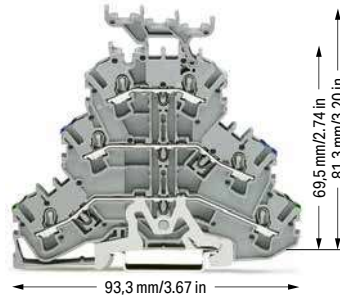

Triple-deck terminal block; ground conductor/through/through terminal block; with marker carrier; gray

	Item No.	Pack. Unit
○ PE/N/L ⑤	2002-3247 ④	50
○ PE/L/L ⑤	2002-3257 ④	50

Triple-deck terminal block; ground conductor/through/through terminal block; without marker carrier; gray		
○ PE/N/L ⑤	2002-3217 ④	50
○ PE/L/L ⑤	2002-3227 ④	50

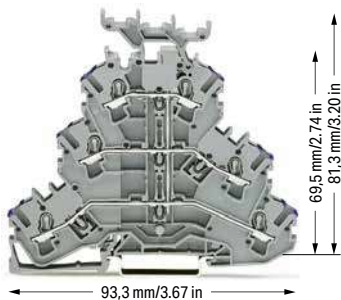

Triple-deck terminal block; 6-conductor through terminal block; with marker carrier; internally commoned; violet conductor entry; gray

	Item No.	Pack. Unit
○ L ⑤	2002-3238 ④	50

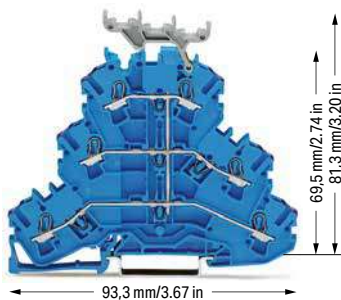

Triple-deck terminal block; 6-conductor through terminal block; with marker carrier; internally commoned; violet conductor entry; blue

	Item No.	Pack. Unit
● N ⑤	2002-3239 ③ ④	50

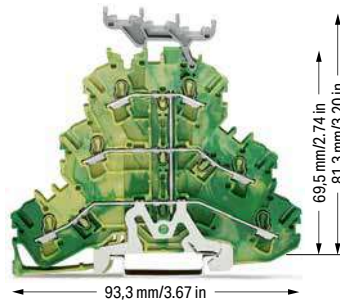

Triple-deck terminal block; 6-conductor ground terminal block; with marker carrier; internally commoned; green-yellow

	Item No.	Pack. Unit
● PE ⑤	2002-3237 ④	50

Triple-deck terminal block; 6-conductor through terminal block; without marker carrier; internally commoned; violet conductor entry; gray		
○ L ⑤	2002-3208 ④	50

Triple-deck terminal block; 6-conductor through terminal block; without marker carrier; internally commoned; violet conductor entry; blue		
● N ⑤	2002-3209 ③ ④	50

Triple-deck terminal block; 6-conductor ground terminal block; without marker carrier; internally commoned; green-yellow		
● PE ⑤	2002-3207 ④	50

Technical Data

0.25 ... 2.5 (4) mm ² ①	22 ... 12 AWG
500 V / 6 kV / 3 ②	300 V, 20 A ③
I _N 24 A (28 A)	600 V, 20 A ④
Terminal block width: 5.2 mm / 0.205 inch	
10 ... 12 mm / 0.39 ... 0.47 inch	

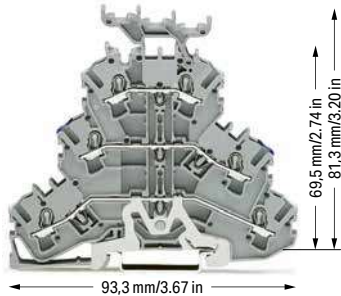

Triple-deck terminal block; shield/through/through terminal block; with marker carrier; gray

	Item No.	Pack. Unit
○ Shield/N/L	2002-3248	50
○ Shield/L/L	2002-3258	50

Triple-deck terminal block; shield/through/through terminal block; without marker carrier; gray

○ Shield/N/L	2002-3218	50
○ Shield/L/L	2002-3228	50

- Conductor range: 0.25 ... 4 mm² "s+f-st"; Push-in termination: 1 ... 4 mm² "s" and 1 ... 2.5 mm² "insulated ferrules, 12 mm" Depending on the conductor characteristic, a conductor with a smaller cross section can also be inserted via push-in termination.
- 500 V = rated voltage
6 kV = rated impulse voltage
3 = pollution degree (see Section 15)
- Terminal blocks with a blue insulated housing are suitable for Ex i applications.
- Terminal blocks with an Ex mark are suitable for Ex e II applications.
440 V, 19 A
17 A jumper (see Section 15)



Please observe the application notes:
Jumpers, from page 182
Testing accessories, page 181
Marking, from page 684

Approvals and corresponding ratings, visit www.wago.com

Accessories; 2002 Series

Appropriate marking systems:
WMB/WMB Inline/Marking strips

End and intermediate plate; 0.8 mm thick

	orange	2002-3292	100 (25)
	gray	2002-3291	100 (25)

Insulation stop; 5 pcs/strip; 0.25 ... 0.5 mm²

	light gray	2002-171	200 (25)
---	------------	----------	----------

Insulation stop; 5 pcs/strip; 0.75 ... 1 mm²

	dark gray	2002-172	200 (25)
---	-----------	----------	----------

Push-in type jumper bar; insulated; I_N 25 A; light gray

	2-way	2002-402	25
	3-way	2002-403	25
	4-way	2002-404	25
	5-way	2002-405	25
	6-way	2002-406	25
	7-way	2002-407	25
	8-way	2002-408	25
	9-way	2002-409	25
	10-way	2002-410	25

Push-in type jumper bar; insulated; I_N 25 A; light gray

	1 to 3	2002-433	25
	1 to 4	2002-434	25
	1 to 5	2002-435	25
	1 to 6	2002-436	25
	1 to 7	2002-437	25
	1 to 8	2002-438	25
	1 to 9	2002-439	25
	1 to 10	2002-440	25

Double-deck vertical jumper; insulated; I_N 24 A

	light gray	2002-492	100 (25)
	orange	2002-492/000-012	100 (25)

Triple-deck vertical jumper; insulated; I_N 24 A

	light gray	2002-493	100 (25)
---	------------	----------	----------

Triple-deck marker carrier; pivoting

	gray	2002-131	50 (25)
---	------	----------	---------



Triple-deck vertical jumpers (2002-493) common to the three levels of triple-deck terminal blocks.

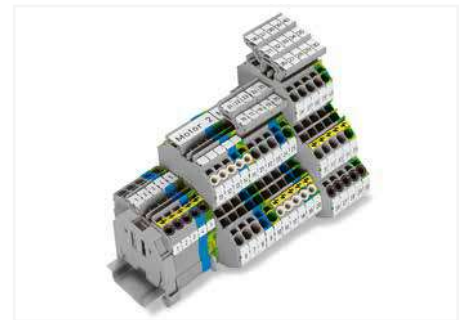

Combination of multilevel terminal blocks



L-type test plug modules (2002-611) for testing rail-mount terminal blocks via conductor entries

Quadruple-Deck Rail-Mount Terminal Block for Wiring of Electric Motors TOPJOB® S

2.5 (4) mm²; 2002 Series

1

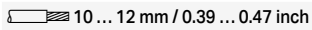
Technical Data	
0.25 ... 2.5 (4) mm ² ①	22 ... 12 AWG
800 V / 8 kV / 3 ②	600 V, 20 A, I_N
I_N 20 A (25 A)	600 V, 20 A ⑥
Terminal block width: 5.2 mm / 0.205 inch	
 10 ... 12 mm / 0.39 ... 0.47 inch	

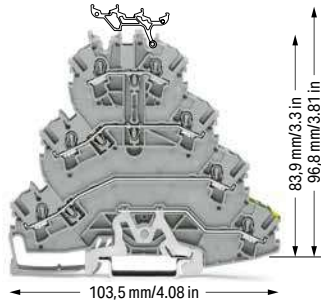

Quadruple-deck rail-mount terminal block; electric motor wiring rail-mount terminal block; without marker carrier; gray

Item No.	Pack. Unit
L1 - L2 - L3 - PE ③ 2002-4127 ⑤	25

Item No.	Pack. Unit
L1 - L2 - L3 - PE ③ 2002-4157 ⑤	25

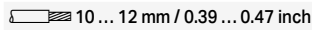
Technical Data	
0.25 ... 2.5 (4) mm ² ①	22 ... 12 AWG
800 V / 8 kV / 3 ②	600 V, 20 A, I_N
I_N 20 A (25 A)	600 V, 20 A ⑥
Terminal block width: 5.2 mm / 0.205 inch	
 10 ... 12 mm / 0.39 ... 0.47 inch	

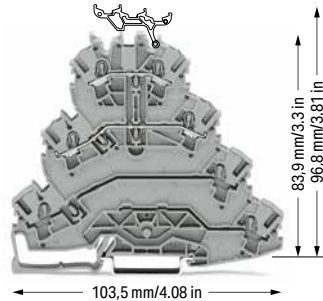

Quadruple-deck rail-mount terminal block; electric motor wiring rail-mount terminal block; without marker carrier; gray

Item No.	Pack. Unit
L1 - L2 ③ 2002-4111 ⑤	25

Item No.	Pack. Unit
L1 - L2 ③ 2002-4141 ⑤	25

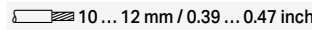
Technical Data	
0.25 ... 2.5 (4) mm ² ①	22 ... 12 AWG
800 V / 8 kV / 3 ②	600 V, 20 A, I_N
I_N 20 A (25 A)	600 V, 20 A ⑥
Terminal block width: 5.2 mm / 0.205 inch	
 10 ... 12 mm / 0.39 ... 0.47 inch	

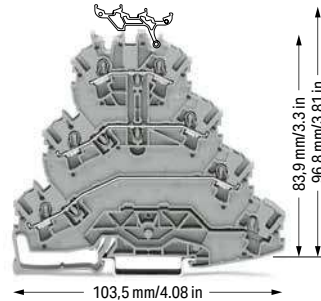



Quadruple-deck rail-mount terminal block; electric motor wiring rail-mount terminal block; without marker carrier; gray

Item No.	Pack. Unit
L1 - L2 - L3 ③ 2002-4101 ⑤	25

Item No.	Pack. Unit
L1 - L2 - L3 ③ 2002-4131 ⑤	25

Accessories; 2002 Series



Appropriate marking systems: WMB/WMB Inline/Marking strips









End and intermediate plate; 1 mm thick			
	orange	2002-4192	100 (25)
	gray	2002-4191	100 (25)









Insulation stop; 5 pcs/strip; 0.25 ... 0.5 mm ²			
	light gray	2002-171	200 (25)

Insulation stop; 5 pcs/strip; 0.75 ... 1 mm ²			
	dark gray	2002-172	200 (25)

Protective warning marker; with black high-voltage symbol; for 5 terminal blocks			
	yellow	2002-115	100 (25)











Lockout cap; for conductor entry and operating slot			
	orange	2002-192	25
	gray	2002-191	25
	blue	2002-194	25

Push-in type jumper bar; insulated; I_N 25 A; light gray			
	2-way	2002-402	25
	3-way	2002-403	25
	4-way	2002-404	25
	5-way	2002-405	25
	6-way	2002-406	25
	7-way	2002-407	25
	8-way	2002-408	25
	9-way	2002-409	25
	10-way	2002-410	25



Push-in type jumper bar; insulated; I_N 25 A; light gray			
	1 to 3	2002-433	25
	1 to 4	2002-434	25
	1 to 5	2002-435	25
	1 to 6	2002-436	25
	1 to 7	2002-437	25
	1 to 8	2002-438	25
	1 to 9	2002-439	25
	1 to 10	2002-440	25



Delta jumper; insulated; $I_N = I_N$ terminal block; light gray			
	1-2 3-4 5-6	2002-406/020-000	25



Star point jumper; insulated; $I_N = I_N$ terminal block; light gray			
	1-3-5	2002-405/011-000	25

Staggered jumper; insulated; I_N 25 A; light gray			
	2-way	2002-472	25
	3-way	2002-473	25
	4-way	2002-474	25
	5-way	2002-475	25
	6-way	2002-476	25
	7-way	2002-477	25
	8-way	2002-478	25
	9-way	2002-479	25
	10-way	2002-480	25
	11-way	2002-481	25
	12-way	2002-482	25

Continuous jumper; insulated; I_N 25 A, light gray			
	5-way	2002-400	25

Continuous jumper; insulated; I_N 25 A; light gray			
	1 to 3	2002-423	25
	1 to 4	2002-424	25

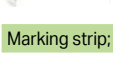
Continuous jumper; insulated; I_N 25 A, light gray			
	3-way	2002-413	25
	5-way	2002-415	25

Push-in type wire jumper; insulated; 1.5 mm ² conductor cross-section; I_N 18 A			
	L = 60 mm	2009-412	100 (10)
	L = 110 mm	2009-414	100 (10)
	L = 250 mm	2009-416	100 (10)

Marking strip; plain; 11 mm wide; 50 m reel			
	white	2009-110	1

WMB Inline, plain; 1,500 WMB markers (5 mm)/reel; 5 ... 5.2 mm stretchable			
	white	2009-115	1

WMB marking card; white; 10 strips with 10 markers/card; 5 ... 5.2 mm stretchable			
	plain	793-5501	5

Triple-deck marker carrier; pivoting			
	gray	2002-131	50 (25)

Double-deck marker carrier; pivoting			
	gray	2002-121	50 (25)

❶ Conductor range: 0.25 ... 4 mm² "s+f-st";
Push-in termination: 1 ... 4 mm² "s" and 1 ... 2.5 mm²
"insulated ferrules, 12 mm"
Depending on the conductor characteristic, a conductor with a smaller cross section can also be inserted via push-in termination.

❷ 800 V = rated voltage
8 kV = rated impulse voltage
3 = pollution degree
(see Section 15)

❸ Terminal blocks with an Ex mark are suitable for Ex e II applications.
440 V, 19 A
17 A jumper
(see Section 15)

Please observe the application notes:
Jumpers, from page 182
Testing accessories, page 181
Marking, from page 684

Approvals and corresponding ratings,
visit www.wago.com



Creating spacer housings for electric motor wiring rail-mount terminal blocks via lockout caps (2002-192) for conductor entry and operating slot.

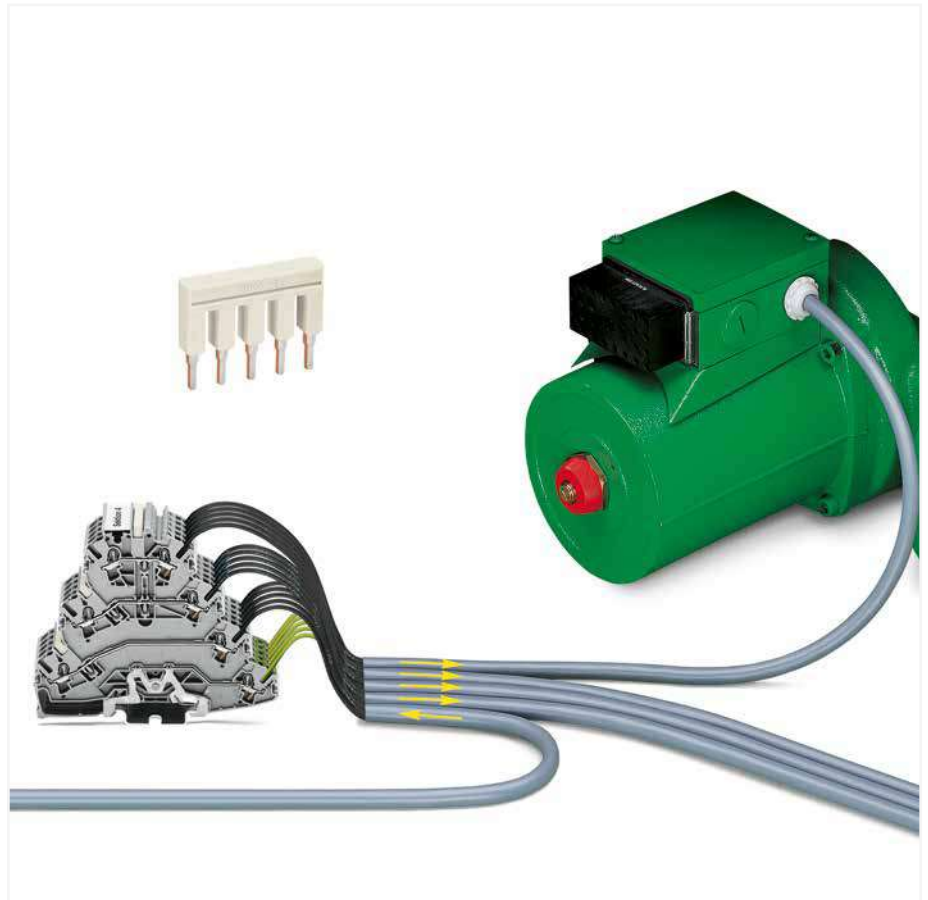

In addition to rail-mount terminal blocks for electric motor wiring, special versions are also available.

- Version without ground contact and only two potentials:
These terminal blocks were custom designed to support additional functions, such as engine brakes or temperature sensors. Sharing a common profile, this terminal block version can be put next to the appropriate electric motor wiring terminal block without using intermediate plates. That makes the rail assembly easier to understand and wire. This also prevents wiring errors as no conductor entry is unused.
- Version without ground contact and with three potentials:
Clearly designated clamping units are the primary advantage to this terminal block design. When using devices with protective insulation, for example, there are no open ground clamping units that could create confusion.



Testing with voltage tester.



Marking clamping points via WMB Multi Marking System.
Group marking via marking strips (Item No. 709-177).

Disconnect/Test Terminal Block, Fuse Terminal Block, Carrier Terminal Block, Through Terminal Block TOPJOB® S; with Push-Button 2.5 (4) mm²; 2202 Series

1

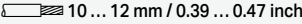
Technical Data	
0.25 ... 2.5 (4) mm ² ①	22 ... 12 AWG
400 V / 6 kV / 3 ②	300 V, 15 A VA
I _N 16 A	300 V, 15 A A
Terminal block width: 5.2 mm / 0.205 inch	
 10 ... 12 mm / 0.39 ... 0.47 inch	

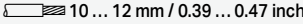
Technical Data	
0.25 ... 2.5 (4) mm ² ①	22 ... 12 AWG
400 V / 6 kV / 3 ②	300 V, 10 A VA
I _N 10 A ③	300 V, 10 A A
Terminal block width: 5.2 mm / 0.205 inch	
 10 ... 12 mm / 0.39 ... 0.47 inch	

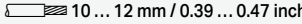
Technical Data	
0.25 ... 2.5 (4) mm ² ①	22 ... 12 AWG
400 V / 6 kV / 3 ②	300 V, 15 A VA
I _N 16 A	300 V, 15 A A
Terminal block width: 5.2 mm / 0.205 inch	
 10 ... 12 mm / 0.39 ... 0.47 inch	

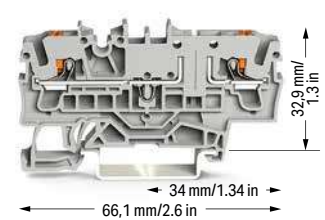
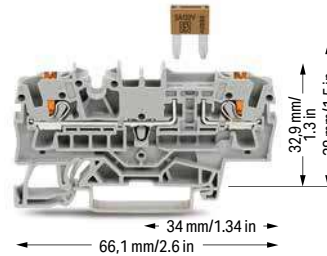
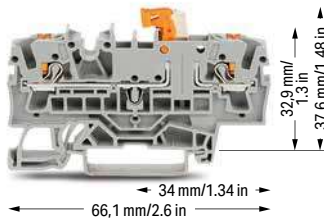

2-conductor disconnect/test terminal block; with push-button; with test point; orange disconnect link

2-conductor fuse terminal block; with push-button; for mini-automotive blade-style fuse; with test point
Electrical ratings are given by the fuse. Blade-style fuses: Observe touch-proof protection for 42 V and higher voltages!

2-conductor carrier terminal block; with push-button; with test point

Color	Item No.	Pack. Unit
gray ⑤	2202-1671 ⑤	50
blue ⑤	2202-1674 ④ ⑤	50
orange ⑤	2202-1672 ⑤	50

Color	Item No.	Pack. Unit
gray	2202-1681	50

Color	Item No.	Pack. Unit
gray ⑤	2202-1661 ⑤	50

Accessories; item-specific
Disconnect plug for carrier terminal blocks; suitable when using a carrier terminal block as disconnect terminal block

	orange	2002-401	100 (25)
---	--------	----------	----------

Accessories; 2202 Series

Appropriate marking systems: WMB/WMB Inline/Marking strips

End and intermediate plate; 1 mm thick			
	orange	2002-1692	100 (25)
	gray	2002-1691	100 (25)

Insulation stop; 5 pcs/strip; 0.25 ... 0.5 mm ²			
	light gray	2002-171	200 (25)

Insulation stop; 5 pcs/strip; 0.75 ... 1 mm ²			
	dark gray	2002-172	200 (25)

Push-in type jumper bar; insulated; I _N 25 A; light gray			
	2-way	2002-402	25
	3-way	2002-403	25
	4-way	2002-404	25
	5-way	2002-405	25
	6-way	2002-406	25
	7-way	2002-407	25
	8-way	2002-408	25
	9-way	2002-409	25
	10-way	2002-410	25

Delta jumper; insulated; I _N = I _N terminal block; light gray			
	1-2 3-4 5-6	2002-406/020-000	25

Push-in type jumper bar; insulated; I _N 25 A; light gray			
	1 to 3	2002-433	25
	1 to 4	2002-434	25
	1 to 5	2002-435	25
	1 to 6	2002-436	25
	1 to 7	2002-437	25
	1 to 8	2002-438	25
	1 to 9	2002-439	25
	1 to 10	2002-440	25

Star point jumper; insulated; I _N = I _N terminal block; light gray			
	1-3-5	2002-405/011-000	25

Continuous jumper; insulated; I _N 25 A, light gray			
	2-way	2002-400	25

Continuous jumper; insulated; I _N 25 A; light gray			
	1 to 3	2002-423	25
	1 to 4	2002-424	25

Continuous jumper; insulated; I _N 25 A, light gray			
	3-way	2002-413	25
	5-way	2002-415	25

Staggered jumper; insulated; I _N 25 A; light gray			
	2-way	2002-472	25
	3-way	2002-473	25
	4-way	2002-474	25
	5-way	2002-475	25
	6-way	2002-476	25
	7-way	2002-477	25
	8-way	2002-478	25
	9-way	2002-479	25
	10-way	2002-480	25
	11-way	2002-481	25
	12-way	2002-482	25

Customized staggered jumper; insulated; with contact lugs broken off at the factory and circuit printing; I _N 25 A; light gray			
	1-3	2002-473/011-000	25
	1-3-5	2002-475/011-000	25
	1-3-5-7	2002-477/011-000	25
	1-3-5-7-9	2002-479/011-000	25
	1-3-5-7-9-11	2002-481/011-000	25

Push-in type wire jumper; insulated; 1.5 mm ² conductor cross-section; I _N 18 A			
	L = 60 mm	2009-412	100 (10)
	L = 110 mm	2009-414	100 (10)
	L = 250 mm	2009-416	100 (10)

Technical Data

0.25 ... 2.5 (4) mm ² ①	22 ... 12 AWG
400 V / 6 kV / 3 ②	300 V, 15 A ④
I _N 16 A	300 V, 15 A ④
Terminal block width: 5.2 mm / 0.205 inch	
 10 ... 12 mm / 0.39 ... 0.47 inch	

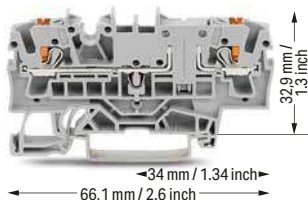

2-conductor through terminal block; with push-button; with test point; same profile as 2-conductor disconnect terminal block

Color	Item No.	Pack. Unit
gray ⑤	2202-1601 ⑤	50
blue ⑤	2202-1604 ④ ⑤	50
orange ⑤	2202-1602 ⑤	50

Other terminal blocks with the same profile:

Fuse	2202-1611	Page 104
------	-----------	----------

① Conductor range: 0.25 ... 4 mm² "s+f-st"; Push-in termination: 1 ... 4 mm² "s" and 1 ... 2.5 mm² "insulated ferrules, 12 mm" Depending on the conductor characteristic, a conductor with a smaller cross section can also be inserted via push-in termination.

② 400 V = rated voltage
6 kV = rated impulse voltage
3 = pollution degree (see Section 15)

③ Observe touch-proof protection for 42 V and higher voltages!
• 10 A (individual arrangement)
• 5 A (block arrangement)

④ Terminal blocks with a blue insulated housing are suitable for Ex i applications.

⑤ Terminal blocks with an Ex mark are suitable for Ex e II applications.
440 V; 17 Ar (see Section 15)

Blade-style fuses are not offered by WAGO.

Please observe the application notes:
Jumpers, from page 182
Testing accessories, from page 177
Marking, from page 684

Approvals and corresponding ratings, visit www.wago.com

Modular connector; snaps together; for jumper contact slot

	gray	2002-511	100 (25)
---	------	----------	----------

Spacer module; snaps together; bridges commoned terminal blocks

	gray	2002-549	100 (25)
---	------	----------	----------

Marking strip; plain; 11 mm wide; 50 m reel

	white	2009-110	1
---	-------	----------	---

WMB Inline; plain; 1,500 WMB markers (5 mm)/reel; stretchable 5 ... 5.2 mm

	white	2009-115	1
---	-------	----------	---

WMB marker card; white; 10 strips with 10 markers/card; stretchable 5 ... 5.2 mm

	plain	793-5501	5
---	-------	----------	---

Disconnect/Test Terminal Block, Fuse Terminal Block, Carrier Terminal Block, Through Terminal Block, Ground Conductor Terminal Block TOPJOB® S; with Push-Button

2.5 (4) mm²; 2202 Series

1

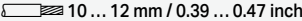
Technical Data	
0.25 ... 2.5 (4) mm ² ①	22 ... 12 AWG
400 V / 6 kV / 3 ②	300 V, 15 A ③
I _N 16 A	300 V, 15 A ④
Terminal block width: 5.2 mm / 0.205 inch	
 10 ... 12 mm / 0.39 ... 0.47 inch	

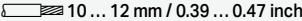
Technical Data	
0.25 ... 2.5 (4) mm ² ①	22 ... 12 AWG
400 V / 6 kV / 3 ②	300 V, 10 A ③
I _N 10 A ④	300 V, 10 A ④
Terminal block width: 5.2 mm / 0.205 inch	
 10 ... 12 mm / 0.39 ... 0.47 inch	

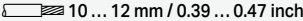
Technical Data	
0.25 ... 2.5 (4) mm ² ①	22 ... 12 AWG
400 V / 6 kV / 3 ②	300 V, 15 A ③
I _N 16 A	300 V, 15 A ④
Terminal block width: 5.2 mm / 0.205 inch	
 10 ... 12 mm / 0.39 ... 0.47 inch	

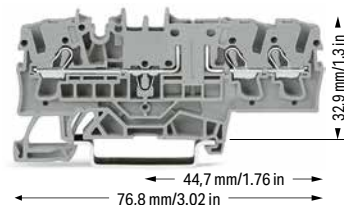
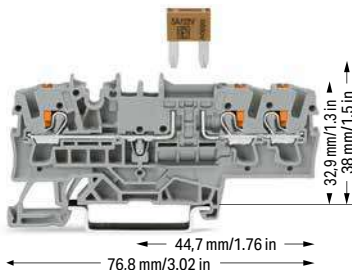
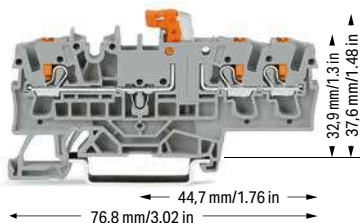

3-conductor disconnect/test terminal block; with push-button; with test point; orange disconnect link

3-conductor fuse terminal block; with push-button; for mini-automotive blade-style fuse; with test point
Electrical ratings are given by the fuse. Blade-style fuses: Observe touch-proof protection for 42 V and higher voltages!

3-conductor carrier terminal block; with push-button; with test point

Color	Item No.	Pack. Unit
gray ⑤	2202-1771 ⑤	50
blue ⑤	2202-1774 ④ ⑤	50
orange ⑤	2202-1772 ⑤	50

Color	Item No.	Pack. Unit
gray	2202-1781	50

Color	Item No.	Pack. Unit
gray ⑤	2202-1761 ⑤	50

Accessories; item-specific

Disconnect plug for carrier terminal blocks; suitable when using a carrier terminal block as disconnect terminal block



orange	2202-401	100 (25)
--------	----------	----------

Accessories; 2202 Series

Appropriate marking systems: WMB/WMB Inline/Marking strips

End and intermediate plate; 1 mm thick

orange	2202-1792	100 (25)
gray	2202-1791	100 (25)

Insulation stop; 5 pcs/strip; 0.25 ... 0.5 mm²

light gray	2002-171	200 (25)
------------	----------	----------

Insulation stop; 5 pcs/strip; 0.75 ... 1 mm²

dark gray	2002-172	200 (25)
-----------	----------	----------

Push-in type jumper bar; insulated; I_N 25 A; light gray

2-way	2002-402	25
3-way	2002-403	25
4-way	2002-404	25
5-way	2002-405	25
6-way	2002-406	25
7-way	2002-407	25
8-way	2002-408	25
9-way	2002-409	25
10-way	2002-410	25

Push-in type jumper bar; insulated; I_N 25 A; light gray

1 to 3	2002-433	25
1 to 4	2002-434	25
1 to 5	2002-435	25
1 to 6	2002-436	25
1 to 7	2002-437	25
1 to 8	2002-438	25
1 to 9	2002-439	25
1 to 10	2002-440	25

Star point jumper; insulated; I_N = I_N terminal block; light gray

1-3-5	2002-405/011-000	25
-------	------------------	----

Delta jumper; insulated; I_N = I_N terminal block; light gray

1-2-3-4-5-6	2002-406/020-000	25
-------------	------------------	----

Continuous jumper; insulated; I_N 25 A; light gray

2-way	2002-400	25
-------	----------	----

Staggered jumper; insulated; I_N 25 A; light gray

2-way	2002-472	25
3-way	2002-473	25
4-way	2002-474	25
5-way	2002-475	25
6-way	2002-476	25
7-way	2002-477	25
8-way	2002-478	25
9-way	2002-479	25
10-way	2002-480	25
11-way	2002-481	25
12-way	2002-482	25

Customized staggered jumper; insulated; with contact lugs broken off at the factory and circuit printing; I_N 25 A; light gray

1-3	2002-473/011-000	25
1-3-5	2002-475/011-000	25
1-3-5-7	2002-477/011-000	25
1-3-5-7-9	2002-479/011-000	25
1-3-5-7-9-11	2002-481/011-000	25

Continuous jumper; insulated; I_N 25 A; light gray

1 to 3	2002-423	25
1 to 4	2002-424	25

Technical Data

0.25 ... 2.5 (4) mm ² ①	22 ... 12 AWG
400 V / 6 kV / 3 ②	300 V, 15 A ③
I _N 16 A	300 V, 15 A ④
Terminal block width: 5.2 mm / 0.205 inch	

 10 ... 12 mm / 0.39 ... 0.47 inch

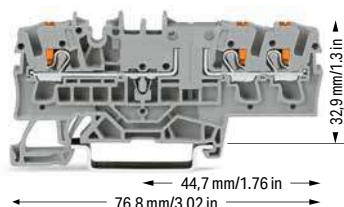

3-conductor through terminal block; with push-button; with test point; same profile as 3-conductor disconnect terminal block

Color	Item No.	Pack. Unit
gray ⑤	2202-1701 ⑤	50
blue ⑤	2202-1704 ④ ⑤	50
orange ⑤	2202-1702 ⑤	50

3-conductor ground terminal block; with push-button; with test point

green-yellow ⑤	2202-1707	50
----------------	-----------	----

Other terminal blocks with the same profile:

Fuse	2202-1711	Page 104
------	-----------	----------

① Conductor range: 0.25 ... 4 mm² "s+f-st"; Push-in termination: 1 ... 4 mm² "s" and 1 ... 2.5 mm² "insulated ferrules, 12 mm" Depending on the conductor characteristic, a conductor with a smaller cross section can also be inserted via push-in termination.

② 400 V = rated voltage
6 kV = rated impulse voltage
3 = pollution degree (see Section 15)

③ Observe touch-proof protection for 42 V and higher voltages!
• 10 A (individual arrangement)
• 5 A (block arrangement)

④ Terminal blocks with a blue insulated housing are suitable for Ex i applications.

⑤ Terminal blocks with an Ex mark are suitable for Ex e II applications.
440 V; 17 Ar (see Section 15)

Blade-style fuses are not offered by WAGO.

Please observe the application notes:
Jumpers, from page 182
Testing accessories, from page 177
Marking, from page 684

Approvals and corresponding ratings, visit www.wago.com

Accessories; 2202 Series

Appropriate marking systems:
WMB/WMB Inline/Marking strips

Marking strip; plain; 11 mm wide; 50 m reel

 white	2009-110	1
---	----------	---

WMB Inline; plain; 1,500 WMB markers (5 mm)/reel; stretchable 5 ... 5.2 mm

 white	2009-115	1
---	----------	---

WMB marker card; white; 10 strips with 10 markers/card; stretchable 5 ... 5.2 mm

 plain	793-5501	5
---	----------	---

Continuous jumper; insulated; I_N 25 A, light gray

 3-way	2002-413	25
5-way	2002-415	25

Push-in type wire jumper; insulated; 1.5 mm² conductor cross-section; I_N 18 A

 L = 60 mm	2009-412	100 (10)
L = 110 mm	2009-414	100 (10)
L = 250 mm	2009-416	100 (10)

Modular connector; snaps together; for jumper contact slot

 gray	2002-511	100 (25)
--	----------	----------

Spacer module; snaps together; bridges commoned terminal blocks

 gray	2002-549	100 (25)
--	----------	----------

Disconnect/Test Terminal Block, Fuse Terminal Block, Carrier Terminal Block, Through Terminal Block TOPJOB® S; with Push-Button 2.5 (4) mm²; 2202 Series

1

Technical Data	
0.25 ... 2.5 (4) mm ² ①	22 ... 12 AWG
400 V / 6 kV / 3 ②	300 V, 15 A ③
I _N 16 A	300 V, 15 A ④
Terminal block width: 5.2 mm / 0.205 inch	
 10 ... 12 mm / 0.39 ... 0.47 inch	

Technical Data	
0.25 ... 2.5 (4) mm ² ①	22 ... 12 AWG
400 V / 6 kV / 3 ②	300 V, 10 A ③
I _N 10 A ④	300 V, 10 A ④
Terminal block width: 5.2 mm / 0.205 inch	
 10 ... 12 mm / 0.39 ... 0.47 inch	

Technical Data	
0.25 ... 2.5 (4) mm ² ①	22 ... 12 AWG
400 V / 6 kV / 3 ②	300 V, 15 A ③
I _N 16 A	300 V, 15 A ④
Terminal block width: 5.2 mm / 0.205 inch	
 10 ... 12 mm / 0.39 ... 0.47 inch	

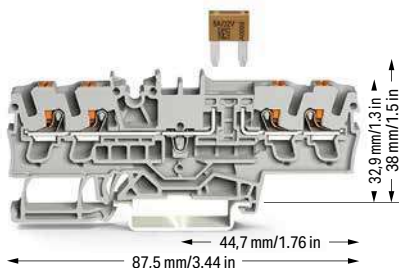

4-conductor disconnect/test terminal block; with push-button; with test point; orange disconnect link

4-conductor fuse terminal block; with push-button; for mini-automotive blade-style fuse; with test point
Electrical ratings are given by the fuse. Blade-style fuses: Observe touch-proof protection for 42 V and higher voltages!

4-conductor carrier terminal block; with push-button; with test point

Color	Item No.	Pack. Unit
gray ⑤	2202-1871 ⑤	50
blue ⑤	2202-1874 ④ ⑤	50
orange ⑤	2202-1872 ⑤	50

Color	Item No.	Pack. Unit
gray	2202-1881	50

Color	Item No.	Pack. Unit
gray ⑤	2202-1861 ⑤	50

Accessories; item-specific
Disconnect plug for carrier terminal blocks; suitable when using a carrier terminal block as disconnect terminal block

	orange	2002-401	100 (25)
---	--------	----------	----------

Accessories; 2202 Series

Appropriate marking systems: WMB/WMB Inline/Marking strips

End and intermediate plate; 1 mm thick			
	orange	2002-1892	100 (25)
	gray	2002-1891	100 (25)

Insulation stop; 5 pcs/strip; 0.25 ... 0.5 mm ²			
	light gray	2002-171	200 (25)

Insulation stop; 5 pcs/strip; 0.75 ... 1 mm ²			
	dark gray	2002-172	200 (25)

Push-in type jumper bar; insulated; I _N 25 A; light gray			
	2-way	2002-402	25
	3-way	2002-403	25
	4-way	2002-404	25
	5-way	2002-405	25
	6-way	2002-406	25
	7-way	2002-407	25
	8-way	2002-408	25
	9-way	2002-409	25
	10-way	2002-410	25

Delta jumper; insulated; I _N = I _N terminal block; light gray			
	1-2 3-4 5-6	2002-406/020-000	25

Push-in type jumper bar; insulated; I _N 25 A; light gray			
	1 to 3	2002-433	25
	1 to 4	2002-434	25
	1 to 5	2002-435	25
	1 to 6	2002-436	25
	1 to 7	2002-437	25
	1 to 8	2002-438	25
	1 to 9	2002-439	25
	1 to 10	2002-440	25

Star point jumper; insulated; I _N = I _N terminal block; light gray			
	1-3-5	2002-405/011-000	25

Continuous jumper; insulated; I _N 25 A; light gray			
	2-way	2002-400	25

Continuous jumper; insulated; I _N 25 A; light gray			
	1 to 3	2002-423	25
	1 to 4	2002-424	25

Continuous jumper; insulated; I _N 25 A; light gray			
	3-way	2002-413	25
	5-way	2002-415	25

Staggered jumper; insulated; I _N 25 A; light gray			
	2-way	2002-472	25
	3-way	2002-473	25
	4-way	2002-474	25
	5-way	2002-475	25
	6-way	2002-476	25
	7-way	2002-477	25
	8-way	2002-478	25
	9-way	2002-479	25
	10-way	2002-480	25
	11-way	2002-481	25
	12-way	2002-482	25

Customized staggered jumper; insulated; with contact lugs broken off at the factory and circuit printing; I _N 25 A; light gray			
	1-3	2002-473/011-000	25
	1-3-5	2002-475/011-000	25
	1-3-5-7	2002-477/011-000	25
	1-3-5-7-9	2002-479/011-000	25
	1-3-5-7-9-11	2002-481/011-000	25

Push-in type wire jumper; insulated; 1.5 mm ² conductor cross-section; I _N 18 A			
	L = 60 mm	2009-412	100 (10)
	L = 110 mm	2009-414	100 (10)
	L = 250 mm	2009-416	100 (10)

Technical Data

0.25 ... 2.5 (4) mm² ① | 22 ... 12 AWG

400 V / 6 kV / 3 ② | 300 V, 15 A ③

I_N 16 A | 300 V, 15 A ④

Terminal block width: 5.2 mm / 0.205 inch

 10 ... 12 mm / 0.39 ... 0.47 inch

4-conductor through terminal block; with push-button; with test point; same profile as 4-conductor disconnect terminal block

Color	Item No.	Pack. Unit
gray ⑤	2202-1801 ⑤	50
blue ⑤	2202-1804 ④ ⑤	50
orange ⑤	2202-1802 ⑤	50

Other terminal blocks with the same profile:

Fuse	2202-1811	Page 105
------	-----------	----------

① Conductor range: 0.25 ... 4 mm² "s+f-st";
Push-in termination: 1 ... 4 mm² "s" and 1 ... 2.5 mm² "insulated ferrules, 12 mm"
Depending on the conductor characteristic, a conductor with a smaller cross section can also be inserted via push-in termination.

② 400 V = rated voltage
6 kV = rated impulse voltage
3 = pollution degree
(see Section 15)

③ Observe touch-proof protection for 42 V and higher voltages!
• 10 A (individual arrangement)
• 5 A (block arrangement)

④ Terminal blocks with a blue insulated housing are suitable for Ex i applications.

⑤ Terminal blocks with an Ex mark are suitable for Ex e II applications.
440 V; 17 Ar
(see Section 15)

Blade-style fuses are not offered by WAGO.

Please observe the application notes:
Jumpers, from page 182
Testing accessories, from page 177
Marking, from page 684

Approvals and corresponding ratings,
visit www.wago.com

Modular connector; snaps together; for jumper contact slot

	gray	2002-511	100 (25)
---	------	----------	----------

Spacer module; snaps together; bridges commoned terminal blocks

	gray	2002-549	100 (25)
---	------	----------	----------

Marking strip; plain; 11 mm wide; 50 m reel

	white	2009-110	1
---	-------	----------	---

WMB Inline; plain; 1,500 WMB markers (5 mm)/reel; stretchable 5 ... 5.2 mm

	white	2009-115	1
---	-------	----------	---

WMB marker card; white; 10 strips with 10 markers/card; stretchable 5 ... 5.2 mm

	plain	793-5501	5
---	-------	----------	---

Disconnect/Test Terminal Block, Fuse Terminal Block, Carrier Terminal Block, Through Terminal Block, Ground Conductor Terminal Block TOPJOB® S; with Push-Button; with Additional Jumper Slot 2.5 (4) mm²; 2202 Series

1

Technical Data	
0.25 ... 2.5 (4) mm ² ①	22 ... 12 AWG
400 V / 6 kV / 3 ②	300 V, 15 A ③
I _N 16 A	300 V, 15 A ④
Terminal block width: 5.2 mm / 0.205 inch	
 10 ... 12 mm / 0.39 ... 0.47 inch	

Technical Data	
0.25 ... 2.5 (4) mm ² ①	22 ... 12 AWG
400 V / 6 kV / 3 ②	300 V, 10 A ③
I _N 10 A ④	300 V, 10 A ⑤
Terminal block width: 5.2 mm / 0.205 inch	
 10 ... 12 mm / 0.39 ... 0.47 inch	

Technical Data	
0.25 ... 2.5 (4) mm ² ①	22 ... 12 AWG
400 V / 6 kV / 3 ②	300 V, 15 A ③
I _N 16 A	300 V, 15 A ④
Terminal block width: 5.2 mm / 0.205 inch	
 10 ... 12 mm / 0.39 ... 0.47 inch	

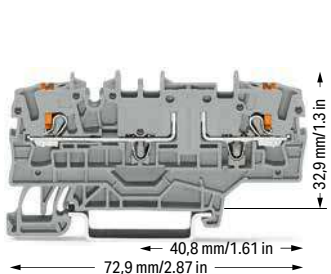
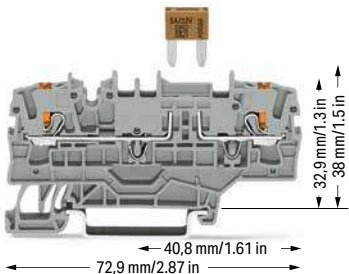
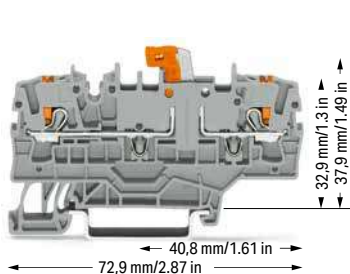

2-conductor disconnect/test terminal block; with push-button; with test point; orange disconnect link; with additional jumper slot

Color	Item No.	Pack. Unit
gray ⑤	2202-1971 ⑤	50
blue ⑤	2202-1974 ④ ⑤	50
orange ⑤	2202-1972 ⑤	50

2-conductor fuse terminal block; with push-button; for mini-automotive blade-style fuse; with test point; without blown fuse indication; with additional jumper slot
Electrical ratings are given by the fuse. Blade-style fuses: Observe touch-proof protection for 42 V and higher voltages!

Color	Item No.	Pack. Unit
gray	2202-1981	50

2-conductor carrier terminal block; with push-button; with test point; with additional jumper slot

Color	Item No.	Pack. Unit
gray ⑤	2202-1961 ⑤	50

Accessories; item-specific



Disconnect plug for carrier terminal blocks; suitable when using a carrier terminal block as disconnect terminal block





orange	2002-401	100 (25)
--------	----------	----------









Accessories; 2202 Series









Appropriate marking systems: WMB/WMB Inline/Marking strips

End and intermediate plate; 1 mm thick			
	orange	2002-1992	100 (25)
	gray	2002-1991	100 (25)

Insulation stop; 5 pcs/strip; 0.25 ... 0.5 mm ²			
	light gray	2002-171	200 (25)

Insulation stop; 5 pcs/strip; 0.75 ... 1 mm ²			
	dark gray	2002-172	200 (25)











Push-in type jumper bar; insulated; I _N 25 A; light gray			
	2-way	2002-402	25
	3-way	2002-403	25
	4-way	2002-404	25
	5-way	2002-405	25
	6-way	2002-406	25
	7-way	2002-407	25
	8-way	2002-408	25
	9-way	2002-409	25
	10-way	2002-410	25

Push-in type jumper bar; insulated; I _N 25 A; light gray			
	1 to 3	2002-433	25
	1 to 4	2002-434	25
	1 to 5	2002-435	25
	1 to 6	2002-436	25
	1 to 7	2002-437	25
	1 to 8	2002-438	25
	1 to 9	2002-439	25
	1 to 10	2002-440	25

Delta jumper; insulated; I _N = I _N terminal block; light gray			
	1-2 3-4 5-6	2002-406/020-000	25

Star point jumper; insulated; I _N = I _N terminal block; light gray			
	1-3-5	2002-405/011-000	25

Continuous jumper; insulated; I _N 25 A; light gray			
	2-way	2002-400	25

Staggered jumper; insulated; I _N 25 A; light gray			
	2-way	2002-472	25
	3-way	2002-473	25
	4-way	2002-474	25
	5-way	2002-475	25
	6-way	2002-476	25
	7-way	2002-477	25
	8-way	2002-478	25
	9-way	2002-479	25
	10-way	2002-480	25
	11-way	2002-481	25
	12-way	2002-482	25

Customized staggered jumper; insulated; with contact lugs broken off at the factory and circuit printing; I_N 25 A; light gray

	1-3	2002-473/011-000	25
	1-3-5	2002-475/011-000	25
	1-3-5-7	2002-477/011-000	25
	1-3-5-7-9	2002-479/011-000	25
	1-3-5-7-9-11	2002-481/011-000	25

Technical Data



0.25 ... 2.5 (4) mm ² ①	22 ... 12 AWG
400 V / 6 kV / 3 ②	300 V, 15 A ④
I _N 16 A	300 V, 15 A ⑤

Terminal block width: 5.2 mm / 0.205 inch

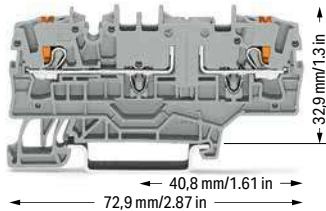
 10 ... 12 mm / 0.39 ... 0.47 inch



2-conductor through terminal block; with push-button; with test point; with additional jumper slot; same profile as 2-conductor disconnect terminal block

Color	Item No.	Pack. Unit
gray 	2202-1901 ⑤	50
blue 	2202-1904 ④ ⑤	50
orange 	2202-1902 ⑤	50

2-conductor ground terminal block; with push-button; with test point; with additional jumper slot

 green-yellow	2202-1907	50
--	-----------	----

Other terminal blocks with the same profile:

Fuse	2202-1911	Page 104
------	-----------	----------

① Conductor range: 0.25 ... 4 mm² "s+f-st"; Push-in termination: 1 ... 4 mm² "s" and 1 ... 2.5 mm² "insulated ferrules, 12 mm" Depending on the conductor characteristic, a conductor with a smaller cross section can also be inserted via push-in termination.

② 400 V = rated voltage
6 kV = rated impulse voltage
3 = pollution degree (see Section 15)

③ Observe touch-proof protection for 42 V and higher voltages!
• 10 A (individual arrangement)
• 5 A (block arrangement)

④ Terminal blocks with a blue insulated housing are suitable for Ex i applications.

⑤ Terminal blocks with an Ex mark are suitable for Ex e II applications.
440 V; 17 Ar (see Section 15)

Blade-style fuses are not offered by WAGO.

Please observe the application notes:
Jumpers, from page 182
Testing accessories, from page 177
Marking, from page 684

Approvals and corresponding ratings, visit www.wago.com

Accessories; 2202 Series

Appropriate marking systems:
WMB/WMB Inline/Marking strips

Marking strip; plain; 11 mm wide; 50 m reel

 white	2009-110	1
---	----------	---

WMB Inline; plain; 1,500 WMB markers (5 mm)/reel; stretchable 5 ... 5.2 mm

 white	2009-115	1
---	----------	---

WMB marker card; white; 10 strips with 10 markers/card; stretchable 5 ... 5.2 mm

 plain	793-5501	5
---	----------	---

Continuous jumper; insulated; I_N 25 A; light gray

 1 to 3	2002-423	25
1 to 4	2002-424	25

Continuous jumper; insulated; I_N 25 A; light gray

 3-way	2002-413	25
5-way	2002-415	25

Push-in type wire jumper; insulated; 1.5 mm² conductor cross-section; I_N 18 A

 L = 60 mm	2009-412	100 (10)
L = 110 mm	2009-414	100 (10)
L = 250 mm	2009-416	100 (10)

Modular connector; snaps together; for jumper contact slot

 gray	2002-511	100 (25)
--	----------	----------

Spacer module; snaps together; bridges commoned terminal blocks

 gray	2002-549	100 (25)
--	----------	----------

Fuse Terminal Block TOPJOB® S; with Push-Button; for Mini-Automotive Blade-Style Fuse; with Additional Jumper Slot 2.5 (4) mm²; 2202 Series

1

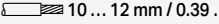
Technical Data	
0.25 ... 2.5 (4) mm ² ①	22 ... 12 AWG
400 V / 6 kV / 3 ②	12 V, 10 A ^{III}
I _N 10 A ③	12 V, 10 A [Ⓞ]
Terminal block width: 5.2 mm / 0.205 inch	
 10 ... 12 mm / 0.39 ... 0.47 inch	

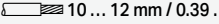
Technical Data	
0.25 ... 2.5 (4) mm ² ①	22 ... 12 AWG
400 V / 6 kV / 3 ②	24 V, 10 A ^{III}
I _N 10 A ③	24 V, 10 A [Ⓞ]
Terminal block width: 5.2 mm / 0.205 inch	
 10 ... 12 mm / 0.39 ... 0.47 inch	

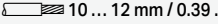
Technical Data	
0.25 ... 2.5 (4) mm ² ①	22 ... 12 AWG
400 V / 6 kV / 3 ②	48 V, 10 A ^{III}
I _N 10 A ③	48 V, 10 A [Ⓞ]
Terminal block width: 5.2 mm / 0.205 inch	
 10 ... 12 mm / 0.39 ... 0.47 inch	

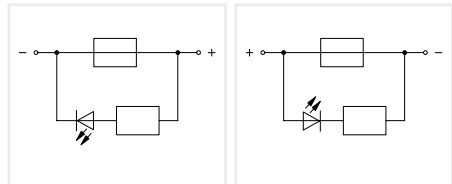
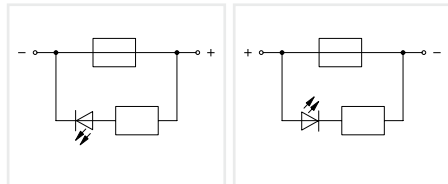
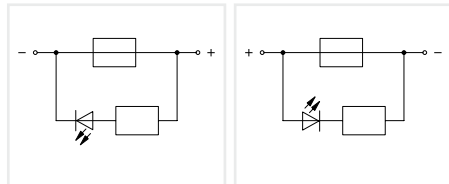
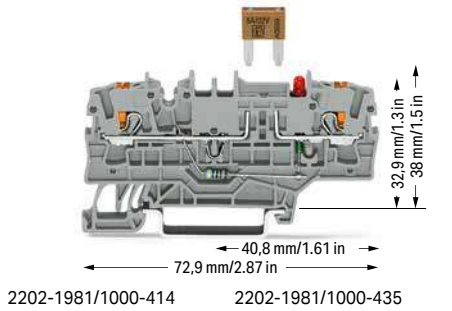
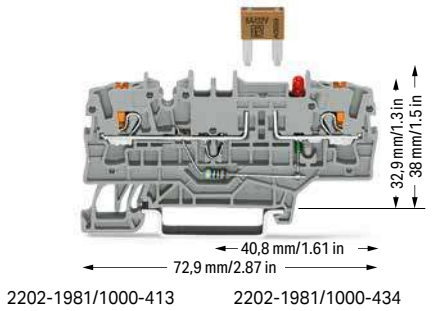
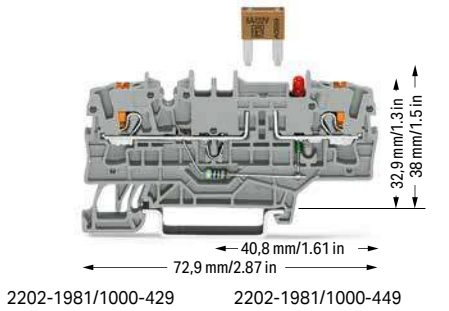

2-conductor fuse terminal block; with push-button; for mini-automotive blade-style fuse; with test point; 12 V; with blown fuse indication by LED; LED power consumption: 4.8 mA; with additional jumper slot; gray Electrical ratings are given by the fuse and blown fuse indication. Blade-style fuses: Observe touch-proof protection for 42 V and higher voltages!

2-conductor fuse terminal block; with push-button; for mini-automotive blade-style fuse; with test point; 24 V; with blown fuse indication by LED; LED power consumption: 4.8 mA; with additional jumper slot; gray Electrical ratings are given by the fuse and blown fuse indication. Blade-style fuses: Observe touch-proof protection for 42 V and higher voltages!

2-conductor fuse terminal block; with push-button; for mini-automotive blade-style fuse; with test point; 48 V; with blown fuse indication by LED; LED power consumption: 4.8 mA; with additional jumper slot; gray Electrical ratings are given by the fuse and blown fuse indication. Blade-style fuses: Observe touch-proof protection for 42 V and higher voltages!

	Item No.	Pack. Unit
○ anode right	2202-1981/1000-429	50
○ anode left	2202-1981/1000-449	50



	Item No.	Pack. Unit
○ anode right	2202-1981/1000-413	50
○ anode left	2202-1981/1000-434	50

	Item No.	Pack. Unit
○ anode right	2202-1981/1000-414	50
○ anode left	2202-1981/1000-435	50

Other terminal blocks with the same profile
Through **2202-1901** Page 101



Accessories; 2202 Series









Appropriate marking systems: WMB/WMB Inline/Marking strips









End and intermediate plate; 1 mm thick			
	orange	2002-1992	100 (25)
	gray	2002-1991	100 (25)











Insulation stop; 5 pcs/strip; 0.25 ... 0.5 mm ²			
	light gray	2002-171	200 (25)

Insulation stop; 5 pcs/strip; 0.75 ... 1 mm ²			
	dark gray	2002-172	200 (25)



Push-in type wire jumper; insulated; 1.5 mm ² conductor cross-section; I _N 18 A			
	L = 60 mm	2009-412	100 (10)
	L = 110 mm	2009-414	100 (10)
	L = 250 mm	2009-416	100 (10)



Push-in type jumper bar; insulated; I _N 25 A; light gray			
	2-way	2002-402	25
	3-way	2002-403	25
	4-way	2002-404	25
	5-way	2002-405	25
	6-way	2002-406	25
	7-way	2002-407	25
	8-way	2002-408	25
	9-way	2002-409	25
	10-way	2002-410	25

Push-in type jumper bar; insulated; I _N 25 A; light gray			
	1 to 3	2002-433	25
	1 to 4	2002-434	25
	1 to 5	2002-435	25
	1 to 6	2002-436	25
	1 to 7	2002-437	25
	1 to 8	2002-438	25
	1 to 9	2002-439	25
	1 to 10	2002-440	25

Staggered jumper; insulated; I _N 25 A; light gray			
	2-way	2002-472	25
	3-way	2002-473	25
	4-way	2002-474	25
	5-way	2002-475	25
	6-way	2002-476	25
	7-way	2002-477	25
	8-way	2002-478	25
	9-way	2002-479	25
	10-way	2002-480	25
	11-way	2002-481	25
	12-way	2002-482	25

Continuous jumper; insulated; I _N 25 A; light gray			
	2-way	2002-400	25

Continuous jumper; insulated; I _N 25 A; light gray			
	1 to 3	2002-423	25
	1 to 4	2002-424	25

Continuous jumper; insulated; I _N 25 A; light gray			
	3-way	2002-413	25
	5-way	2002-415	25

Technical Data	
0.25 ... 2.5 (4) mm ² ①	22 ... 12 AWG
400 V / 6 kV / 3 ②	300 V, 10 A ③
I _N 10 A ③	300 V, 10 A ③
Terminal block width: 5.2 mm / 0.205 inch	
10 ... 12 mm / 0.39 ... 0.47 inch	

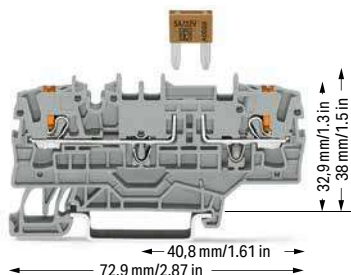

① Conductor range: 0.25 ... 2.5 mm² "s+f-st" and 0.25 ... 4 mm² "s";
 Push-in termination: 1 ... 4 mm² "s" and 1 ... 2.5 mm² "insulated ferrules, 12 mm"
 Depending on the conductor characteristic, a conductor with a smaller cross section can also be inserted via push-in termination.

② 400 V = rated voltage
 6 kV = rated impulse voltage
 3 = pollution degree (see Section 15)

③ Observe touch-proof protection for 42 V and higher voltages!
 • 10 A (individual arrangement)
 • 5 A (block arrangement)

Blade-style fuses are not offered by WAGO.

Please observe the application notes:
 Jumpers, from page 182
 Testing accessories, from page 177
 Marking, from page 684

Approvals and corresponding ratings, visit www.wago.com

2-conductor fuse terminal block; with push-button; for mini-automotive blade-style fuse; with test point; without blown fuse indication; with additional jumper slot
 Electrical ratings are given by the fuse. Blade-style fuses: Observe touch-proof protection for 42 V and higher voltages!

Color	Item No.	Pack. Unit
○ gray	2202-1981	50

Marking strip; plain; 11 mm wide; 50 m reel

	white	2009-110	1
---	-------	----------	---

WMB Inline; plain; 1,500 WMB markers (5 mm)/reel; stretchable 5 ... 5.2 mm

	white	2009-115	1
---	-------	----------	---

WMB marker card; white; 10 strips with 10 markers/card; stretchable 5 ... 5.2 mm

	plain	793-5501	5
---	-------	----------	---

Double-deck marker carrier; pivoting

	gray	2002-121	50 (25)
---	------	----------	---------

Fused Disconnect Terminal Block with a Pivoting Fuse Holder TOPJOB® S; with Push-Button; for (5 x 20) mm Glass Cartridge Fuse 2.5 (4) mm²; 2202 Series

1

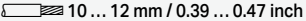
Technical Data	
0.25 ... 2.5 (4) mm ² ①	22 ... 12 AWG
250 V / 6 kV / 3 ②	250 V, 10 A ③
I _N 6.3 A	250 V, 10 A ④
Terminal block width: 6.2 mm / 0.244 inch	
 10 ... 12 mm / 0.39 ... 0.47 inch	

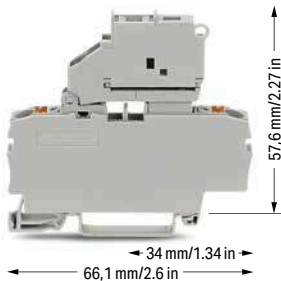

2-conductor fused disconnect terminal block with a pivoting fuse holder; with push-button; for (5 x 20) mm glass cartridge fuse; without blown fuse indication
Electrical ratings are given by the fuse.

	Item No.	Pack. Unit
○ gray	2202-1611	50

2-conductor fused disconnect terminal block with a pivoting fuse holder; with push-button; for (5 x 20) mm glass cartridge fuse; with blown fuse indication by LED; gray
Electrical ratings are given by the fuse and blown fuse indication. Leakage current in case of a blown fuse: LED 2 mA

○ 12 ... 30 V	2202-1611/1000-541 ⑤	50
○ 30 ... 65 V	2202-1611/1000-542 ⑥	50
○ 120 V	2202-1611/1000-867	50
○ 230 V	2202-1611/1000-836	50

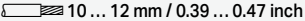
Technical Data	
0.25 ... 2.5 (4) mm ² ①	22 ... 12 AWG
250 V / 6 kV / 3 ②	250 V, 10 A ③
I _N 6.3 A	250 V, 10 A ④
Terminal block width: 6.2 mm / 0.244 inch	
 10 ... 12 mm / 0.39 ... 0.47 inch	

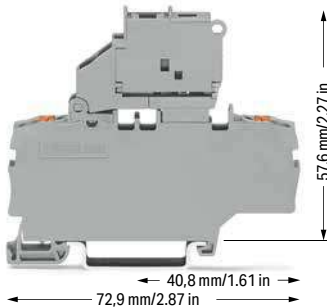

2-conductor fused disconnect terminal block with a pivoting fuse holder; with push-button; with additional jumper slot; for (5 x 20) mm glass cartridge fuse; without blown fuse indication
Electrical ratings are given by the fuse.

	Item No.	Pack. Unit
○ gray	2202-1911	50

2-conductor fused disconnect terminal block with a pivoting fuse holder; with push-button; with additional jumper slot; for (5 x 20) mm glass cartridge fuse; with blown fuse indication; gray
Electrical ratings are given by the fuse and blown fuse indication. Leakage current in case of a blown fuse: LED 2 mA

○ 12 ... 30 V	2202-1911/1000-541 ⑤	50
○ 30 ... 65 V	2202-1911/1000-542 ⑥	50
○ 120 V	2202-1911/1000-867	50
○ 230 V	2202-1911/1000-836	50

Accessories; item-specific

Push-in type wire jumper; insulated; 1.5 mm² conductor cross section; I_N 18 A

 L = 60 mm	2009-412	100 (10)
L = 110 mm	2009-414	100 (10)
L = 250 mm	2009-416	100 (10)

Other terminal blocks with the same profile:

Through	2202-1601	Page 95
---------	-----------	---------

Other terminal blocks with the same profile:

Through	2202-1901	Page 101
---------	-----------	----------

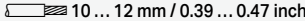
Technical Data	
0.25 ... 2.5 (4) mm ² ①	22 ... 12 AWG
250 V / 6 kV / 3 ②	250 V, 10 A ③
I _N 6.3 A	250 V, 10 A ④
Terminal block width: 6.2 mm / 0.244 inch	
 10 ... 12 mm / 0.39 ... 0.47 inch	

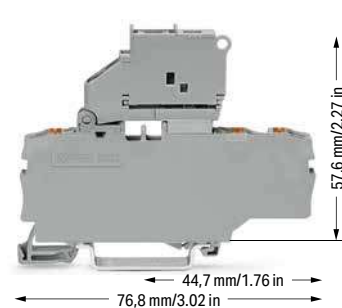

3-conductor fused disconnect terminal block with a pivoting fuse holder; with push-button; for (5 x 20) mm glass cartridge fuse; without blown fuse indication
Electrical ratings are given by the fuse.

	Item No.	Pack. Unit
○ gray	2202-1711	50

3-conductor fused disconnect terminal block with a pivoting fuse holder; with push-button; for (5 x 20) mm glass cartridge fuse; with blown fuse indication by LED; gray
Electrical ratings are given by the fuse and blown fuse indication. Leakage current in case of a blown fuse: LED 2 mA

○ 12 ... 30 V	2202-1711/1000-541 ⑤	50
○ 30 ... 65 V	2202-1711/1000-542 ⑥	50
○ 120 V	2202-1711/1000-867	50
○ 230 V	2202-1711/1000-836	50

Accessories; 2202 Series

Appropriate marking systems: WMB/WMB Inline/Marking strips

End plate for fuse terminal blocks; 2 mm thick

 orange	2002-992	100 (25)
gray	2002-991	100 (25)

Insulation stop; 5 pcs/strip; 0.25 ... 0.5 mm²

 light gray	2002-171	200 (25)
--	----------	----------

Insulation stop; 5 pcs/strip; 0.75 ... 1 mm²

 dark gray	2002-172	200 (25)
---	----------	----------

Interlocking link; mechanically locks multiple links; 1 m long

 transparent	210-254	1
--	---------	---

Push-in type jumper bar; insulated; I_N 32 A; light gray

 2-way	2004-402	25
3-way	2004-403	25
4-way	2004-404	25
5-way	2004-405	25
6-way	2004-406	25
7-way	2004-407	25
8-way	2004-408	25
9-way	2004-409	25
10-way	2004-410	25

Push-in type jumper bar; insulated; I_N 32 A; light gray

 1 to 3	2004-433	25
1 to 4	2004-434	25
1 to 5	2004-435	25
1 to 6	2004-436	25
1 to 7	2004-437	25
1 to 8	2004-438	25
1 to 9	2004-439	25
1 to 10	2004-440	25

Marking strip; plain; 11 mm wide; 50 m reel

 white	2009-110	1
---	----------	---

WMB marker card; white; 10 strips with 10 markers/card; stretchable 5 ... 5.2 mm

 plain	793-5501	5
---	----------	---

Technical Data

0.25 ... 2.5 (4) mm ² ①	22 ... 12 AWG
250 V / 6 kV / 3 ②	250 V, 10 A ③
I _N 6.3 A	250 V, 10 A ④
Terminal block width: 6.2 mm / 0.244 inch	
10 ... 12 mm / 0.39 ... 0.47 inch	



4-conductor fused disconnect terminal block with a pivoting fuse holder; with push-button; for (5 x 20) mm glass cartridge fuse; without blown fuse indication
Electrical ratings are given by the fuse.

	Item No.	Pack. Unit
<input type="radio"/> gray	2202-1811	50

4-conductor fused disconnect terminal block with a pivoting fuse holder; with push-button; for (5 x 20) mm glass cartridge fuse; with blown fuse indication by LED; gray
Electrical ratings are given by the fuse and blown fuse indication. Leakage current in case of a blown fuse: LED 2 mA

<input type="radio"/> 12 ... 30 V	2202-1811/1000-541 ③	50
<input type="radio"/> 30 ... 65 V	2202-1811/1000-542 ④	50
<input type="radio"/> 120 V	2202-1811/1000-867	50
<input type="radio"/> 230 V	2202-1811/1000-836	50

Other terminal blocks with the same profile:

Through	2202-1801	Page 99
---------	-----------	---------

① Conductor range: 0.25 ... 2.5 mm² "s+f-st" and 0.25 ... 4 mm² "s";
Push-in termination: 1 ... 4 mm² "s" and 1 ... 2.5 mm² "insulated ferrules, 12 mm"
Depending on the conductor characteristic, a conductor with a smaller cross section can also be inserted via push-in termination.

② 250 V = rated voltage
6 kV = rated impulse voltage
3 = pollution degree (see Section 15)

③ 30 V / 0,8 kV / 3

④ 65 V / 1,5 kV / 3

Please observe the application notes:
Jumpers, from page 185
Marking, from page 684

A protective warning marker and an insulation stop must be applied individually. Due to the 6.2 mm width of double-deck terminal blocks with end plates, 2004 Series Push-In Type Jumper Bars must be used.

Approvals and corresponding ratings, visit www.wago.com

Miniature fuses 5 x 20

Series Item No.	Overload and short circuit protection		Short circuit protection only	
	Individual argmt.	Group argmt.	Individual argmt.	Group argmt.
Fuse terminal blocks				
2202-1611				
2202-1711	1.6 W	1.6 W	2.5 W	2.5 W
2202-1811				
2202-1611/.....				
2202-1711/.....	1.6 W	1.6 W	2.5 W	2.5 W
2202-1811/.....				

When selecting glass cartridge fuses, make sure that the maximum power loss listed below is not exceeded. The power loss is determined according to IEC or EN 60947-7-3/VDE 0611-6 at 23°C. The temperature rise of the terminal block must be checked according to their application and mounting. Higher ambient temperatures represent an additional impact on miniature fuses. Therefore, in such applications, the rated current must be reduced if necessary. More details are available from the manufacturers.

Miniature fuses 5 x 20

Series Item No.	Overload and short circuit protection		Short circuit protection only	
	Individual argmt.	Group argmt.	Individual argmt.	Group argmt.
Fuse terminal blocks				
2202-1911	1.6 W	1.6 W	2.5 W	2.5 W
2202-1911/.....	1.6 W	1.6 W	2.5 W	2.5 W

When selecting glass cartridge fuses, make sure that the maximum power loss listed below is not exceeded. The power loss is determined according to IEC or EN 60947-7-3/VDE 0611-6 at 23°C. The temperature rise of the terminal block must be checked according to their application and mounting. Higher ambient temperatures represent an additional impact on miniature fuses. Therefore, in such applications, the rated current must be reduced if necessary. More details are available from the manufacturers.

Disconnect/Test Terminal Block, Fuse Terminal Block, Carrier Terminal Block, Through Terminal Block TOPJOB® S

2.5 (4) mm²; 2002 Series

1

Technical Data	
0.25 ... 2.5 (4) mm ² ①	22 ... 12 AWG
400 V / 6 kV / 3 ②	300 V, 15 A ③
I _N 16 A	300 V, 15 A ④
Terminal block width: 5.2 mm / 0.205 inch	
10 ... 12 mm / 0.39 ... 0.47 inch	



2-conductor disconnect/test terminal block; with test point; orange disconnect link

Color	Item No.	Pack. Unit
gray ⑤	2002-1671 ⑥	50
blue ⑤	2002-1674 ④ ⑤	50
orange ⑤	2002-1672 ⑥	50

Technical Data	
0.25 ... 2.5 (4) mm ² ①	22 ... 12 AWG
400 V / 6 kV / 3 ②	300 V, 15 A ③
I _N 16 A	300 V, 15 A ④
Terminal block width: 5.2 mm / 0.205 inch	
10 ... 12 mm / 0.39 ... 0.47 inch	

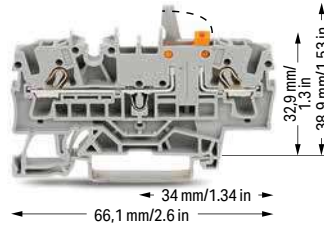

2-conductor disconnect/test terminal block; with mechanical interlock; with test point; orange disconnect link

Color	Item No.	Pack. Unit
gray ⑤	2002-1671/401-000 ⑤	50
blue ⑤	2002-1674/401-000 ④ ⑤	50
orange ⑤	2002-1672/401-000 ⑥	50

Technical Data	
0.25 ... 2.5 (4) mm ² ①	22 ... 12 AWG
400 V / 6 kV / 3 ②	250 V, 10 A ③
I _N 10 A ④	250 V, 10 A ⑤
Terminal block width: 5.2 mm / 0.205 inch	
10 ... 12 mm / 0.39 ... 0.47 inch	

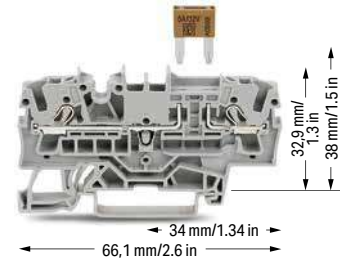

2-conductor fuse terminal block; for mini-automotive blade-style fuse; with test point
Electrical ratings are given by the fuse. Blade-style fuses: Observe touch-proof protection for 42 V and higher voltages!

Color	Item No.	Pack. Unit
gray	2002-1681	50

Accessories; 2002 Series

Appropriate marking systems: WMB/WMB Inline/Marking strips

End and intermediate plate; 1 mm thick			
orange	2002-1692	100 (25)	
gray	2002-1691	100 (25)	

Ex e/Ex i separator; orange; 3 mm thick		
120 mm	209-191	50 (25)

Insulation stop; 5 pcs/strip; 0.25 ... 0.5 mm ²		
light gray	2002-171	200 (25)

Insulation stop; 5 pcs/strip; 0.75 ... 1 mm ²		
dark gray	2002-172	200 (25)

Push-in type jumper bar; insulated; I _N 25 A; light gray		
2-way	2002-402	25
3-way	2002-403	25
4-way	2002-404	25
5-way	2002-405	25
6-way	2002-406	25
7-way	2002-407	25
8-way	2002-408	25
9-way	2002-409	25
10-way	2002-410	25

Push-in type jumper bar; insulated; I _N 25 A; light gray		
1 to 3	2002-433	25
1 to 4	2002-434	25
1 to 5	2002-435	25

1 to 6	2002-436	25
1 to 7	2002-437	25
1 to 8	2002-438	25
1 to 9	2002-439	25
1 to 10	2002-440	25

Delta jumper; insulated; I _N = I _N terminal block; light gray		
1-2 3-4 5-6	2002-406/020-000	25

Star point jumper; insulated; I _N = I _N terminal block; light gray		
1-3-5	2002-405/011-000	25

Continuous jumper; insulated; I _N 25 A; light gray		
2-way	2002-400	25

Continuous jumper; insulated; I _N 25 A; light gray		
1 to 3	2002-423	25
1 to 4	2002-424	25

Continuous jumper; insulated; I _N 25 A; light gray		
3-way	2002-413	25
5-way	2002-415	25

Staggered jumper; insulated; I _N 25 A; light gray		
2-way	2002-472	25
3-way	2002-473	25
4-way	2002-474	25
5-way	2002-475	25
6-way	2002-476	25
7-way	2002-477	25
8-way	2002-478	25
9-way	2002-479	25
10-way	2002-480	25
11-way	2002-481	25
12-way	2002-482	25

Customized staggered jumper; insulated; with contact lugs broken off at the factory and circuit printing; I _N 25 A; light gray		
1-3	2002-473/011-000	25
1-3-5	2002-475/011-000	25
1-3-5-7	2002-477/011-000	25
1-3-5-7-9	2002-479/011-000	25
1-3-5-7-9-11	2002-481/011-000	25

Push-in type wire jumper; insulated; 1.5 mm ² conductor cross-section; I _N 18 A		
L = 60 mm	2009-412	100 (10)
L = 110 mm	2009-414	100 (10)
L = 250 mm	2009-416	100 (10)

Technical Data	
0.25 ... 2.5 (4) mm ² ①	22 ... 12 AWG
400 V / 6 kV / 3 ②	300 V, 15 A
I _N 16 A	300 V, 15 A
Terminal block width: 5.2 mm / 0.205 inch	
10 ... 12 mm / 0.39 ... 0.47 inch	

Technical Data	
0.25 ... 2.5 (4) mm ² ①	22 ... 12 AWG
400 V / 6 kV / 3 ②	300 V, 15 A
I _N 16 A	300 V, 15 A
Terminal block width: 5.2 mm / 0.205 inch	
10 ... 12 mm / 0.39 ... 0.47 inch	

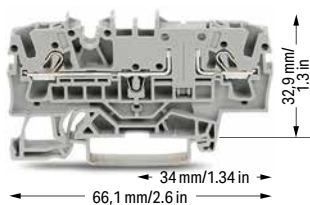
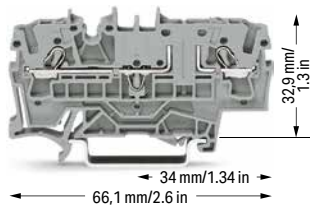

2-conductor carrier terminal block; with test point

2-conductor through terminal block; with test point; same profile as 2-conductor disconnect terminal block

Color	Item No.	Pack. Unit
gray	2002-1661 ⑤	50

Color	Item No.	Pack. Unit
gray	2002-1601 ⑤	50
blue	2002-1604 ④ ⑤	50
orange	2002-1602 ⑤	50

Accessories; item-specific
Disconnect plug for carrier terminal blocks; suitable when using a carrier terminal block as disconnect terminal block

	orange	2002-401	100 (25)
--	--------	----------	----------

Protective warning marker; with black high-voltage symbol; for 5 terminal blocks

	yellow	2002-115	100 (25)
--	--------	----------	----------

Modular connector; snaps together; for jumper contact slot

	gray	2002-511	100 (25)
--	------	----------	----------

Spacer module; snaps together; bridges commoned terminal blocks

	gray	2002-549	100 (25)
--	------	----------	----------

Marking strip; plain; 11 mm wide; 50 m reel

	white	2009-110	1
--	-------	----------	---

WMB Inline; plain; 1,500 WMB markers (5 mm)/reel; stretchable 5 ... 5.2 mm

	white	2009-115	1
--	-------	----------	---

WMB marker card; white; 10 strips with 10 markers/card; stretchable 5 ... 5.2 mm

	plain	793-5501	5
--	-------	----------	---

- Conductor range: 0.25 ... 4 mm² "s+f-st"; Push-in termination: 1 ... 4 mm² "s" and 1 ... 2.5 mm² "insulated ferrules, 12 mm" Depending on the conductor characteristic, a conductor with a smaller cross section can also be inserted via push-in termination.
- 400 V = rated voltage
6 kV = rated impulse voltage
3 = pollution degree (see Section 15)
- Observe touch-proof protection for 42 V and higher voltages!
• 10 A (individual arrangement)
• 5 A (block arrangement)
- Terminal blocks with a blue insulated housing are suitable for Ex i applications.
- Terminal blocks with an Ex mark are suitable for Ex e II applications.
440 V; 17 A (see Section 15)

Blade-style fuses are not offered by WAGO.

Please observe the application notes:
Jumpers, from page 182
Testing accessories, from page 177
Marking, from page 684

Approvals and corresponding ratings, visit www.wago.com

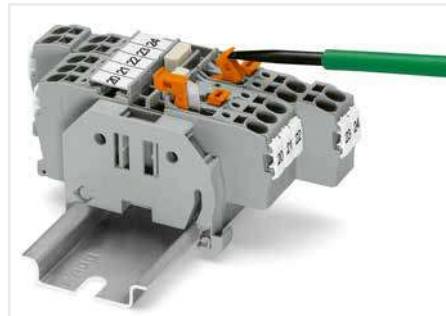

Disconnect/test terminal block with pivoting knife disconnect – opening a knife disconnect.



Disconnect/test terminal block with pivoting knife disconnect – closing the knife disconnect.



Disconnect/test terminal block with pivoting knife disconnect – testing with voltage tester.

Disconnect/Test Terminal Block, Fuse Terminal Block, Carrier Terminal Block, Through Terminal Block, Ground Conductor Terminal Block TOPJOB® S

2.5 (4) mm²; 2002 Series

1

Technical Data	
0.25 ... 2.5 (4) mm ² ①	22 ... 12 AWG
400 V / 6 kV / 3 ②	300 V, 15 A ③
I _N 16 A	300 V, 15 A ④
Terminal block width: 5.2 mm / 0.205 inch	
10 ... 12 mm / 0.39 ... 0.47 inch	

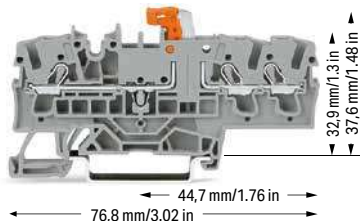

3-conductor disconnect/test terminal block; with test point; orange disconnect link

Color	Item No.	Pack. Unit
gray ⑤	2002-1771 ⑥	50
blue ⑤	2002-1774 ④ ⑤	50
orange ⑤	2002-1772 ⑥	50

Technical Data	
0.25 ... 2.5 (4) mm ² ①	22 ... 12 AWG
400 V / 6 kV / 3 ②	300 V, 15 A ③
I _N 16 A	300 V, 15 A ④
Terminal block width: 5.2 mm / 0.205 inch	
10 ... 12 mm / 0.39 ... 0.47 inch	

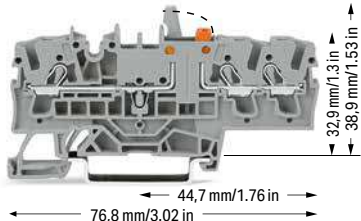

3-conductor disconnect/test terminal block; with mechanical interlock; with test point; orange disconnect link

Color	Item No.	Pack. Unit
gray ⑤	2002-1771/401-000 ⑤	50
blue ⑤	2002-1774/401-000 ④ ⑤	50
orange ⑤	2002-1772/401-000 ⑥	50

Technical Data	
0.25 ... 2.5 (4) mm ² ①	22 ... 12 AWG
400 V / 6 kV / 3 ②	250 V, 10 A ③
I _N 10 A ④	250 V, 10 A ④
Terminal block width: 5.2 mm / 0.205 inch	
10 ... 12 mm / 0.39 ... 0.47 inch	

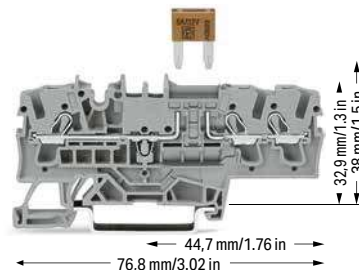

3-conductor fuse terminal block; for mini-automotive blade-style fuse; with test point
Electrical ratings are given by the fuse. Blade-style fuses: Observe touch-proof protection for 42 V and higher voltages!

Color	Item No.	Pack. Unit
gray	2002-1781	50

Accessories; 2002 Series

Appropriate marking systems: WMB/WMB Inline/Marking strips

End and intermediate plate; 1 mm thick			
orange	2002-1792	100 (25)	
gray	2002-1791	100 (25)	

Ex e/Ex i separator; orange; 3 mm thick			
120 mm	209-191	50 (25)	

Insulation stop; 5 pcs/strip; 0.25 ... 0.5 mm ²			
light gray	2002-171	200 (25)	

Insulation stop; 5 pcs/strip; 0.75 ... 1 mm ²			
dark gray	2002-172	200 (25)	

Delta jumper; insulated; I _N = I _N terminal block; light gray			
1-2 3-4 5-6	2002-406/020-000	25	

Star point jumper; insulated; I _N = I _N terminal block; light gray			
1-3-5	2002-405/011-000	25	

Push-in type jumper bar; insulated; I _N 25 A; light gray			
2-way	2002-402	25	
3-way	2002-403	25	
4-way	2002-404	25	
5-way	2002-405	25	
6-way	2002-406	25	
7-way	2002-407	25	
8-way	2002-408	25	
9-way	2002-409	25	
10-way	2002-410	25	

Push-in type jumper bar; insulated; I _N 25 A; light gray			
1 to 3	2002-433	25	
1 to 4	2002-434	25	
1 to 5	2002-435	25	
1 to 6	2002-436	25	
1 to 7	2002-437	25	
1 to 8	2002-438	25	
1 to 9	2002-439	25	
1 to 10	2002-440	25	

Continuous jumper; insulated; I _N 25 A; light gray			
2-way	2002-400	25	

Continuous jumper; insulated; I _N 25 A; light gray			
1 to 3	2002-423	25	
1 to 4	2002-424	25	

Continuous jumper; insulated; I _N 25 A; light gray			
3-way	2002-413	25	
5-way	2002-415	25	

Staggered jumper; insulated; I _N 25 A; light gray			
2-way	2002-472	25	
3-way	2002-473	25	
4-way	2002-474	25	
5-way	2002-475	25	
6-way	2002-476	25	
7-way	2002-477	25	
8-way	2002-478	25	
9-way	2002-479	25	
10-way	2002-480	25	
11-way	2002-481	25	
12-way	2002-482	25	

PUSH-IN CAGE CLAMP®

1

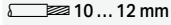
Technical Data	
0.25 ... 2.5 (4) mm ² ①	22 ... 12 AWG
400 V / 6 kV / 3 ②	300 V, 15 A ③
I _N 16 A	300 V, 15 A ④
Terminal block width: 5.2 mm / 0.205 inch	
 10 ... 12 mm / 0.39 ... 0.47 inch	

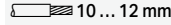
Technical Data	
0.25 ... 2.5 (4) mm ² ①	22 ... 12 AWG
400 V / 6 kV / 3 ②	300 V, 15 A ③
I _N 16 A	300 V, 15 A ④
Terminal block width: 5.2 mm / 0.205 inch	
 10 ... 12 mm / 0.39 ... 0.47 inch	

- Conductor range: 0.25 ... 4 mm² "s+f-st"; Push-in termination: 1 ... 4 mm² "s" and 1 ... 2.5 mm² "insulated ferrules, 12 mm" Depending on the conductor characteristic, a conductor with a smaller cross section can also be inserted via push-in termination.
- 400 V = rated voltage
6 kV = rated impulse voltage
3 = pollution degree (see Section 15)
- Observe touch-proof protection for 42 V and higher voltages!
• 10 A (individual arrangement)
• 5 A (block arrangement)
- Terminal blocks with a blue insulated housing are suitable for Ex i applications.
- Terminal blocks with an Ex mark are suitable for Ex e II applications.
440 V; 17 A (see Section 15)

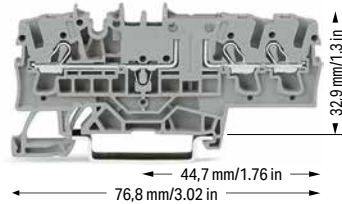
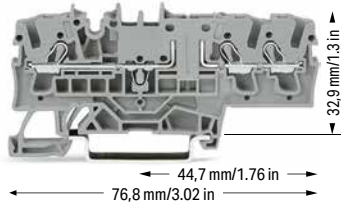

3-conductor carrier terminal block; with test point

3-conductor through terminal block; with test point; same profile as 3-conductor disconnect terminal block

Color	Item No.	Pack. Unit
gray ⑤	2002-1761 ⑤	50

Color	Item No.	Pack. Unit
gray ⑤	2002-1701 ⑤	50
blue ⑤	2002-1704 ④ ⑤	50
orange ⑤	2002-1702 ⑤	50

Blade-style fuses are not offered by WAGO.

Please observe the application notes:
Jumpers, from page 182
Testing accessories, from page 177
Marking, from page 684

Approvals and corresponding ratings, visit www.wago.com

Accessories; item-specific
Disconnect plug for carrier terminal blocks; suitable when using a carrier terminal block as disconnect terminal block

	orange	2002-401	100 (25)
---	--------	----------	----------

3-conductor ground terminal block; mit Prüfmöglichkeit
green-yellow ⑤ 2002-1707 ⑤ 50

Other terminal blocks with the same profile:
Fuse 2002-1711 Page 116



Disconnect/test terminal block with pivoting knife disconnect and mechanical interlock – knife disconnect in open position

Customized staggered jumper; insulated; with contact lugs broken off at the factory and circuit printing; I_N 25 A; light gray

	1-3	2002-473/011-000	25
	1-3-5	2002-475/011-000	25
	1-3-5-7	2002-477/011-000	25
	1-3-5-7-9	2002-479/011-000	25
	1-3-5-7-9-11	2002-481/011-000	25

Spacer module; snaps together; bridges commoned terminal blocks

	gray	2002-549	100 (25)
---	------	----------	----------

Marking strip; plain; 11 mm wide; 50 m reel

	white	2009-110	1
---	-------	----------	---

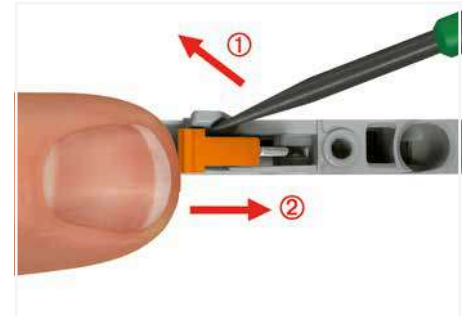

Disconnect/test terminal block with pivoting knife disconnect and mechanical interlock – closing the knife disconnect.

Push-in type wire jumper; insulated; 1.5 mm² conductor cross-section; I_N 18 A

	L = 60 mm	2009-412	100 (10)
	L = 110 mm	2009-414	100 (10)
	L = 250 mm	2009-416	100 (10)

WMB Inline; plain; 1,500 WMB markers (5 mm)/reel; stretchable 5 ... 5.2 mm

	white	2009-115	1
---	-------	----------	---

Protective warning marker; with black high-voltage symbol; for 5 terminal blocks

	yellow	2002-115	100 (25)
---	--------	----------	----------

WMB marker card; white; 10 strips with 10 markers/card; stretchable 5 ... 5.2 mm

	plain	793-5501	5
---	-------	----------	---



Disconnect/test terminal block with pivoting knife disconnect – testing with voltage tester.

Modular connector; snaps together; for jumper contact slot

	gray	2002-511	100 (25)
---	------	----------	----------

Disconnect/Test Terminal Block, Fuse Terminal Block, Carrier Terminal Block, Through Terminal Block TOPJOB® S

2.5 (4) mm²; 2002 Series

1

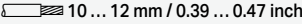
Technical Data	
0.25 ... 2.5 (4) mm ² ①	22 ... 12 AWG
400 V / 6 kV / 3 ②	300 V, 15 A ③
I _N 16 A	300 V, 15 A ④
Terminal block width: 5.2 mm / 0.205 inch	
 10 ... 12 mm / 0.39 ... 0.47 inch	

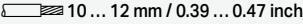
Technical Data	
0.25 ... 2.5 (4) mm ² ①	22 ... 12 AWG
400 V / 6 kV / 3 ②	300 V, 15 A ③
I _N 16 A	300 V, 15 A ④
Terminal block width: 5.2 mm / 0.205 inch	
 10 ... 12 mm / 0.39 ... 0.47 inch	

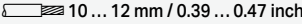
Technical Data	
0.25 ... 2.5 (4) mm ² ①	22 ... 12 AWG
400 V / 6 kV / 3 ②	250 V, 10 A ③
I _N 10 A ④	250 V, 10 A ④
Terminal block width: 5.2 mm / 0.205 inch	
 10 ... 12 mm / 0.39 ... 0.47 inch	

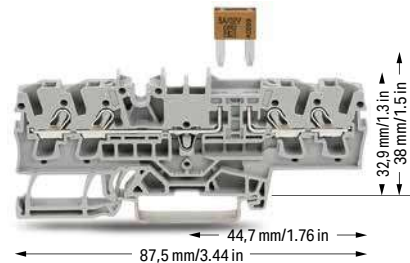
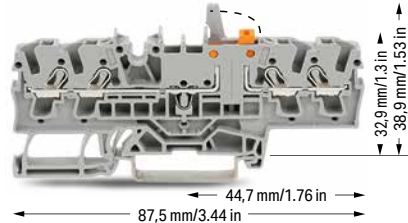
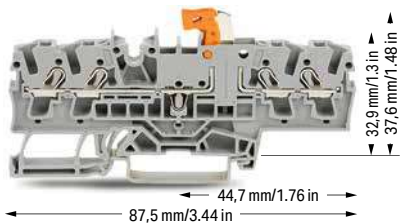

4-conductor disconnect/test terminal block; with test point; orange disconnect link

4-conductor disconnect/test terminal block; with mechanical interlock; with test point; orange disconnect link

4-conductor fuse terminal block; for mini-automotive blade-style fuse; with test point
Electrical ratings are given by the fuse. Blade-style fuses: Observe touch-proof protection for 42 V and higher voltages!



Color	Item No.	Pack. Unit
gray ⑤	2002-1871 ⑥	50
blue ⑤	2002-1874 ④ ⑤	50
orange ⑤	2002-1872 ⑥	50

Color	Item No.	Pack. Unit
gray ⑤	2002-1871/401-000 ⑤	50
blue ⑤	2002-1874/401-000 ④ ⑤	50
orange ⑤	2002-1872/401-000 ⑥	50

Color	Item No.	Pack. Unit
gray	2002-1881	50

Accessories; 2002 Series









Appropriate marking systems: WMB/WMB Inline/Marking strips









End and intermediate plate; 1 mm thick			
	orange	2002-1892	100 (25)
	gray	2002-1891	100 (25)

Ex e/Ex i separator; orange; 3 mm thick			
	120 mm	209-191	50 (25)

Insulation stop; 5 pcs/strip; 0.25 ... 0.5 mm ²			
	light gray	2002-171	200 (25)

Insulation stop; 5 pcs/strip; 0.75 ... 1 mm ²			
	dark gray	2002-172	200 (25)



Push-in type jumper bar; insulated; I _N 25 A; light gray			
	2-way	2002-402	25
	3-way	2002-403	25
	4-way	2002-404	25
	5-way	2002-405	25
	6-way	2002-406	25
	7-way	2002-407	25
	8-way	2002-408	25
	9-way	2002-409	25
	10-way	2002-410	25



Push-in type jumper bar; insulated; I _N 25 A; light gray			
	1 to 3	2002-433	25
	1 to 4	2002-434	25
	1 to 5	2002-435	25
	1 to 6	2002-436	25
	1 to 7	2002-437	25
	1 to 8	2002-438	25
	1 to 9	2002-439	25
	1 to 10	2002-440	25











Delta jumper; insulated; I _N = I _N terminal block; light gray			
	1-2 3-4 5-6	2002-406/020-000	25





Star point jumper; insulated; I _N = I _N terminal block; light gray			
	1-3-5	2002-405/011-000	25

Continuous jumper; insulated; I _N 25 A; light gray			
	2-way	2002-400	25

Continuous jumper; insulated; I _N 25 A; light gray			
	1 to 3	2002-423	25
	1 to 4	2002-424	25

Continuous jumper; insulated; I _N 25 A; light gray			
	3-way	2002-413	25
	5-way	2002-415	25

Staggered jumper; insulated; I _N 25 A; light gray			
	2-way	2002-472	25
	3-way	2002-473	25
	4-way	2002-474	25
	5-way	2002-475	25
	6-way	2002-476	25
	7-way	2002-477	25
	8-way	2002-478	25
	9-way	2002-479	25
	10-way	2002-480	25
	11-way	2002-481	25
	12-way	2002-482	25

Customized staggered jumper; insulated; with contact lugs broken off at the factory and circuit printing; I _N 25 A; light gray			
	1-3	2002-473/011-000	25
	1-3-5	2002-475/011-000	25
	1-3-5-7	2002-477/011-000	25
	1-3-5-7-9	2002-479/011-000	25
	1-3-5-7-9-11	2002-481/011-000	25

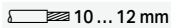
Technical Data	
0.25 ... 2.5 (4) mm ² ①	22 ... 12 AWG
400 V / 6 kV / 3 ②	300 V, 15 A ③
I _N 16 A	300 V, 15 A ④
Terminal block width: 5.2 mm / 0.205 inch	
 10 ... 12 mm / 0.39 ... 0.47 inch	

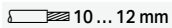
Technical Data	
0.25 ... 2.5 (4) mm ² ①	22 ... 12 AWG
400 V / 6 kV / 3 ②	300 V, 15 A ③
I _N 16 A	300 V, 15 A ④
Terminal block width: 5.2 mm / 0.205 inch	
 10 ... 12 mm / 0.39 ... 0.47 inch	

- ① Conductor range: 0.25 ... 4 mm² "s+f-st"; Push-in termination: 1 ... 4 mm² "s" and 1 ... 2.5 mm² "insulated ferrules, 12 mm" Depending on the conductor characteristic, a conductor with a smaller cross section can also be inserted via push-in termination.
- ② 400 V = rated voltage
6 kV = rated impulse voltage
3 = pollution degree (see Section 15)
- ③ Observe touch-proof protection for 42 V and higher voltages!
• 10 A (individual arrangement)
• 5 A (block arrangement)
- ④ Terminal blocks with a blue insulated housing are suitable for Ex i applications.
- ⑤ Terminal blocks with an Ex mark are suitable for Ex e II applications.
440 V; 17 A (see Section 15)

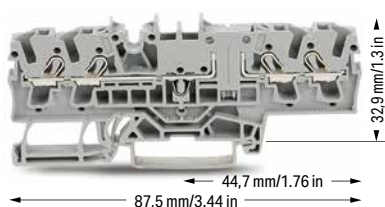
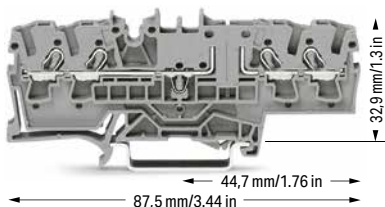

4-conductor carrier terminal block; with test point

4-conductor through terminal block; with test point; same profile as 4-conductor disconnect terminal block

Color	Item No.	Pack. Unit
○ gray ⑤	2002-1861 ⑤	50

Color	Item No.	Pack. Unit
○ gray ⑤	2002-1801 ⑤	50
● blue ⑤	2002-1804 ④ ⑤	50
● orange ⑤	2002-1802 ⑤	50

Blade-style fuses are not offered by WAGO.

Please observe the application notes:
Jumpers, from page 182
Testing accessories, from page 177
Marking, from page 684

Approvals and corresponding ratings, visit www.wago.com

Accessories; item-specific

Disconnect plug for carrier terminal blocks; suitable when using a carrier terminal block as disconnect terminal block

	orange	2002-401	100 (25)
---	--------	----------	----------

Push-in type wire jumper; insulated; 1.5 mm² conductor cross-section; I_N 18 A

	L = 60 mm	2009-412	100 (10)
	L = 110 mm	2009-414	100 (10)
	L = 250 mm	2009-416	100 (10)

Protective warning marker; with black high-voltage symbol; for 5 terminal blocks

	yellow	2002-115	100 (25)
---	--------	----------	----------

Modular connector; snaps together; for jumper contact slot

	gray	2002-511	100 (25)
---	------	----------	----------

Spacer module; snaps together; bridges commoned terminal blocks

	gray	2002-549	100 (25)
---	------	----------	----------

Marking strip; plain; 11 mm wide; 50 m reel

	white	2009-110	1
---	-------	----------	---

WMB Inline; plain; 1,500 WMB markers (5 mm)/reel; stretchable 5 ... 5.2 mm

	white	2009-115	1
---	-------	----------	---

WMB marker card; white; 10 strips with 10 markers/card; stretchable 5 ... 5.2 mm

	plain	793-5501	5
---	-------	----------	---



Disconnect/test terminal block with pivoting knife disconnect and mechanical interlock – top view



Carrier terminal block (2002-1861) with disconnect plug (2002-401) in parked position

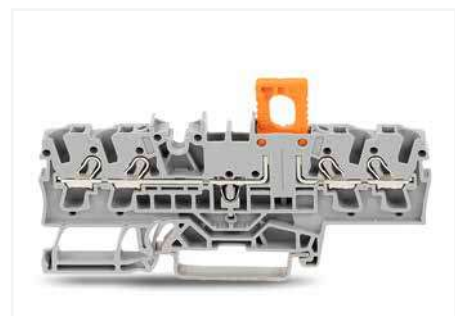



Carrier terminal block (2002-1861) with disconnect plug (2002-401) in operating position

Disconnect/Test Terminal Block, Fuse Terminal Block, Carrier Terminal Block, Through Terminal Block, Ground Conductor Terminal Block TOPJOB® S; with Additional Jumper Slot 2.5 (4) mm²; 2002 Series

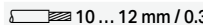
1

Technical Data	
0.25 ... 2.5 (4) mm ² ①	22 ... 12 AWG
400 V / 6 kV / 3 ②	300 V, 15 A ③
I _N 16 A	300 V, 15 A ④
Terminal block width: 5.2 mm / 0.205 inch	
 10 ... 12 mm / 0.39 ... 0.47 inch	

Technical Data	
0.25 ... 2.5 (4) mm ² ①	22 ... 12 AWG
400 V / 6 kV / 3 ②	300 V, 15 A ③
I _N 16 A	300 V, 15 A ④
Terminal block width: 5.2 mm / 0.205 inch	
 10 ... 12 mm / 0.39 ... 0.47 inch	

Technical Data	
0.25 ... 2.5 (4) mm ² ①	22 ... 12 AWG
400 V / 6 kV / 3 ②	250 V, 10 A ③
I _N 10 A ④	250 V, 10 A ④
Terminal block width: 5.2 mm / 0.205 inch	
 10 ... 12 mm / 0.39 ... 0.47 inch	

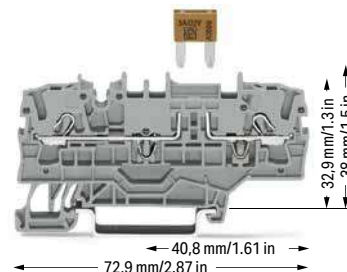
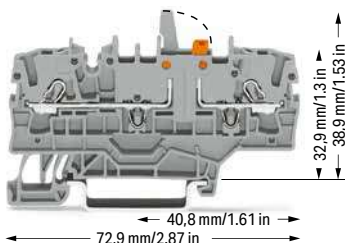
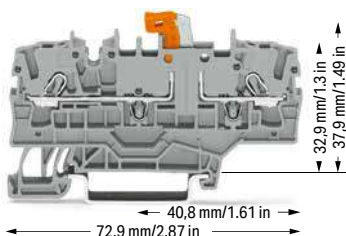

2-conductor disconnect/test terminal block; with test point; orange disconnect link; with additional jumper slot

2-conductor disconnect/test terminal block; with mechanical interlock; with test point; orange disconnect link; with additional jumper slot

2-conductor fuse terminal block; for mini-automotive blade-style fuse; with test point; without blown fuse indication; with additional jumper slot
Electrical ratings are given by the fuse. Blade-style fuses: Observe touch-proof protection for 42 V and higher voltages!

Color	Item No.	Pack. Unit
gray ⑤	2002-1971 ⑤	50
blue ⑤	2002-1974 ④ ⑤	50
orange ⑤	2002-1972 ⑤	50

Color	Item No.	Pack. Unit
gray ⑤	2002-1971/401-000 ⑤	50
blue ⑤	2002-1974/401-000 ④ ⑤	50
orange ⑤	2002-1972/401-000 ⑤	50

Color	Item No.	Pack. Unit
gray	2002-1981	50

Accessories; 2002 Series

Appropriate marking systems: WMB/WMB Inline/Marking strips

End and intermediate plate; 1 mm thick

 orange	2002-1992	100 (25)
 gray	2002-1991	100 (25)

Ex e/Ex i separator; orange; 3 mm thick

 120 mm	209-191	50 (25)
---	---------	---------

Insulation stop; 5 pcs/strip; 0.25 ... 0.5 mm²

 light gray	2002-171	200 (25)
---	----------	----------

Insulation stop; 5 pcs/strip; 0.75 ... 1 mm²

 dark gray	2002-172	200 (25)
--	----------	----------









Delta jumper; insulated; I_N = I_N terminal block; light gray

 1-2 3-4 5-6	2002-406/020-000	25
--	------------------	----

Push-in type jumper bar; insulated; I_N 25 A; light gray

 2-way	2002-402	25
 3-way	2002-403	25
 4-way	2002-404	25
 5-way	2002-405	25
 6-way	2002-406	25
 7-way	2002-407	25
 8-way	2002-408	25
 9-way	2002-409	25
 10-way	2002-410	25











Push-in type jumper bar; insulated; I_N 25 A; light gray

 1 to 3	2002-433	25
 1 to 4	2002-434	25
 1 to 5	2002-435	25
 1 to 6	2002-436	25
 1 to 7	2002-437	25
 1 to 8	2002-438	25
 1 to 9	2002-439	25
 1 to 10	2002-440	25

Star point jumper; insulated; I_N = I_N terminal block; light gray

 1-3-5	2002-405/011-000	25
---	------------------	----

Staggered jumper; insulated; I_N 25 A; light gray

 2-way	2002-472	25
 3-way	2002-473	25
 4-way	2002-474	25
 5-way	2002-475	25
 6-way	2002-476	25
 7-way	2002-477	25
 8-way	2002-478	25
 9-way	2002-479	25
 10-way	2002-480	25
 11-way	2002-481	25
 12-way	2002-482	25

Customized staggered jumper; insulated; with contact lugs broken off at the factory and circuit printing; I_N 25 A; light gray

 1-3	2002-473/011-000	25
 1-3-5	2002-475/011-000	25
 1-3-5-7	2002-477/011-000	25
 1-3-5-7-9	2002-479/011-000	25
 1-3-5-7-9-11	2002-481/011-000	25

Technical Data	
0.25 ... 2.5 (4) mm ² ①	22 ... 12 AWG
400 V / 6 kV / 3 ②	300 V, 15 A ^{III}
I _N 16 A	300 V, 15 A [Ⓞ]
Terminal block width: 5.2 mm / 0.205 inch	
 10 ... 12 mm / 0.39 ... 0.47 inch	

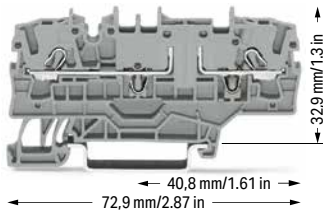

2-conductor carrier terminal block; with test point; with additional jumper slot

Color	Item No.	Pack. Unit
 gray ⑤	2002-1961 ⑤	50

Technical Data	
0.25 ... 2.5 (4) mm ² ①	22 ... 12 AWG
400 V / 6 kV / 3 ②	300 V, 15 A ^{III}
I _N 16 A	300 V, 15 A [Ⓞ]
Terminal block width: 5.2 mm / 0.205 inch	
 10 ... 12 mm / 0.39 ... 0.47 inch	

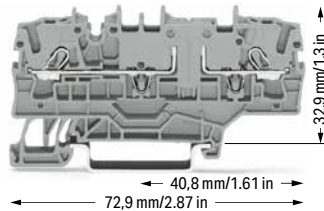

2-Leiter-Durchgangsklemme; mit Prüfmöglichkeit; with additional jumper slot; konturengleich zu 2-Leiter-Trennklemme
2-conductor through terminal block; with test point; same profile as 2-conductor disconnect terminal block

Color	Item No.	Pack. Unit
 gray ⑤	2002-1901 ⑤	50
 blue ⑤	2002-1904 ④ ⑤	50
 orange ⑤	2002-1902 ⑤	50

2-conductor ground terminal block; mit Prüfmöglichkeit; with additional jumper slot	
 green-yellow ⑤	2002-1907 ⑤ 50



Other terminal blocks with the same profile:		
Fuse	2002-1911	Page 116



Accessories; item-specific



Disconnect plug for carrier terminal blocks; suitable when using a carrier terminal block as disconnect terminal block

	orange	2002-401	100 (25)
---	--------	----------	----------

Continuous jumper; insulated; I _N 25 A; light gray			
	2-way	2002-400	25

Continuous jumper; insulated; I _N 25 A; light gray			
	1 to 3	2002-423	25
	1 to 4	2002-424	25

Continuous jumper; insulated; I _N 25 A; light gray			
	3-way	2002-413	25
	5-way	2002-415	25

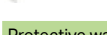
Push-in type wire jumper; insulated; 1.5 mm ² conductor cross-section; I _N 18 A			
	L = 60 mm	2009-412	100 (10)
	L = 110 mm	2009-414	100 (10)
	L = 250 mm	2009-416	100 (10)

Protective warning marker; with black high-voltage symbol; for 5 terminal blocks			
	yellow	2002-115	100 (25)

Modular connector; snaps together; for jumper contact slot			
	gray	2002-511	100 (25)

Marking strip; plain; 11 mm wide; 50 m reel			
	white	2009-110	1

WMB Inline; plain; 1,500 WMB markers (5 mm)/reel; stretchable 5 ... 5.2 mm			
	white	2009-115	1

WMB marker card; white; 10 strips with 10 markers/card; stretchable 5 ... 5.2 mm			
	plain	793-5501	5

① Conductor range: 0.25 ... 4 mm² "s+f-st"; Push-in termination: 1 ... 4 mm² "s" and 1 ... 2.5 mm² "insulated ferrules, 12 mm"
Depending on the conductor characteristic, a conductor with a smaller cross section can also be inserted via push-in termination.

② 400 V = rated voltage
6 kV = rated impulse voltage
3 = pollution degree (see Section 15)

③ Observe touch-proof protection for 42 V and higher voltages!
• 10 A (individual arrangement)
• 5 A (block arrangement)

④ Terminal blocks with a blue insulated housing are suitable for Ex i applications.

⑤ Terminal blocks with an Ex mark are suitable for Ex e II applications.
440 V; 17 A (see Section 15)

Blade-style fuses are not offered by WAGO.

Please observe the application notes: Jumpers, from page 182
Testing accessories, from page 177
Marking, from page 684

Approvals and corresponding ratings, visit www.wago.com

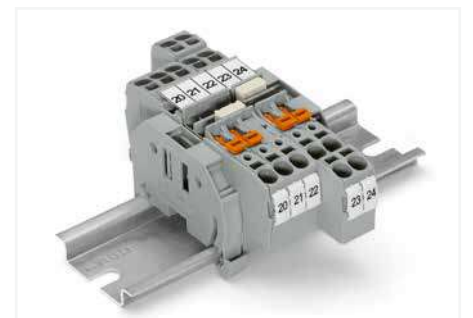

Through Terminal Blocks and Disconnect/Test Terminal Blocks

- One center and two side marker slots for WMB markers or marking strips
- Dual jumper slots in the same location as other 2002 Series terminal blocks
- Commoning options in front of or behind the knife disconnect, depending on the power supply direction

Fuse Terminal Block TOPJOB® S; for Mini-Automotive Blade-Style Fuse; with Additional Jumper Slot

2.5 (4) mm²; 2002 Series

1

Technical Data

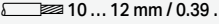
0.25 ... 2.5 (4) mm ² ①	22 ... 12 AWG
400 V / 6 kV / 3 ②	12 V, 10 A ③
I _N 10 A ③	
Terminal block width: 5.2 mm / 0.205 inch	
 10 ... 12 mm / 0.39 ... 0.47 inch	

Technical Data

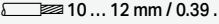
0.25 ... 2.5 (4) mm ² ①	22 ... 12 AWG
400 V / 6 kV / 3 ②	24 V, 10 A ③
I _N 10 A ③	
Terminal block width: 5.2 mm / 0.205 inch	
 10 ... 12 mm / 0.39 ... 0.47 inch	

Technical Data

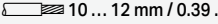
0.25 ... 2.5 (4) mm ² ①	22 ... 12 AWG
400 V / 6 kV / 3 ②	48 V, 10 A ③
I _N 10 A ③	
Terminal block width: 5.2 mm / 0.205 inch	
 10 ... 12 mm / 0.39 ... 0.47 inch	

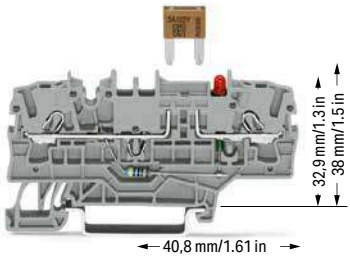

2002-1981/1000-429 2002-1981/1000-449

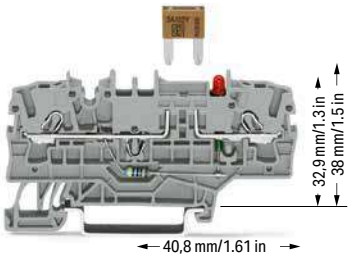

2002-1981/1000-413 2002-1981/1000-434

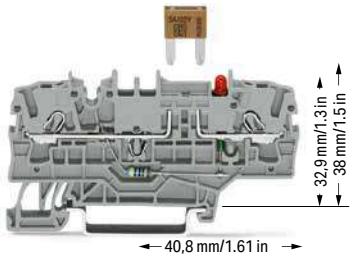

2002-1981/1000-414 2002-1981/1000-435

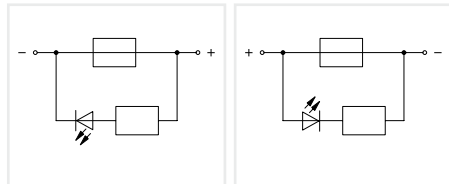

2-conductor fuse terminal block; for mini-automotive blade-style fuse; with test point; 12 V; with blown fuse indication by LED; LED power consumption: 4.8 mA; gray Electrical ratings are given by the fuse and blown fuse indication. Blade-style fuses: Observe touch-proof protection for 42 V and higher voltages!

	Item No.	Pack. Unit
○ anode right	2002-1981/1000-429	50
○ anode left	2002-1981/1000-449	50

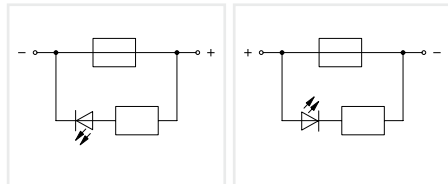

2-conductor fuse terminal block; for mini-automotive blade-style fuse; with test point; 24 V; with blown fuse indication by LED; LED power consumption: 4.8 mA; gray Electrical ratings are given by the fuse and blown fuse indication. Blade-style fuses: Observe touch-proof protection for 42 V and higher voltages!

	Item No.	Pack. Unit
○ anode right	2002-1981/1000-413	50
○ anode left	2002-1981/1000-434	50

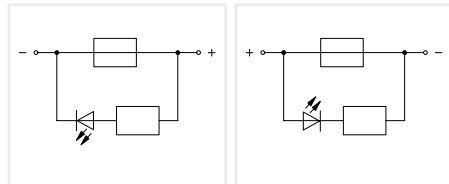

2-conductor fuse terminal block; for mini-automotive blade-style fuse; with test point; 48 V; with blown fuse indication by LED; LED power consumption: 4.8 mA; gray Electrical ratings are given by the fuse and blown fuse indication. Blade-style fuses: Observe touch-proof protection for 42 V and higher voltages!

	Item No.	Pack. Unit
○ anode right	2002-1981/1000-414	50
○ anode left	2002-1981/1000-435	50

Other terminal blocks with the same profile:
Through **2002-1901** Page 113

Accessories; 2002 Series

Appropriate marking systems: WMB/WMB Inline/Marking strips

End and intermediate plate; 1 mm thick

 orange	2002-1992	100 (25)
 gray	2002-1991	100 (25)

Ex e/Ex i separator; orange; 3 mm thick

 120 mm	209-191	50 (25)
---	---------	---------

Insulation stop; 5 pcs/strip; 0.25 ... 0.5 mm²

 light gray	2002-171	200 (25)
--	----------	----------



Insulation stop; 5 pcs/strip; 0.75 ... 1 mm²

 dark gray	2002-172	200 (25)
---	----------	----------









Protective warning marker; with black high-voltage symbol; for 5 terminal blocks

 yellow	2002-115	100 (25)
--	----------	----------









Push-in type wire jumper; insulated; 1.5 mm² conductor cross-section; I_N 18 A

 L = 60 mm	2009-412	100 (10)
 L = 110 mm	2009-414	100 (10)
 L = 250 mm	2009-416	100 (10)











Push-in type jumper bar; insulated; I_N 25 A; light gray

 2-way	2002-402	25
 3-way	2002-403	25
 4-way	2002-404	25
 5-way	2002-405	25
 6-way	2002-406	25
 7-way	2002-407	25
 8-way	2002-408	25
 9-way	2002-409	25
 10-way	2002-410	25

Push-in type jumper bar; insulated; I_N 25 A; light gray

 1 to 3	2002-433	25
 1 to 4	2002-434	25
 1 to 5	2002-435	25
 1 to 6	2002-436	25
 1 to 7	2002-437	25
 1 to 8	2002-438	25
 1 to 9	2002-439	25
 1 to 10	2002-440	25

Staggered jumper; insulated; I_N 25 A; light gray

 2-way	2002-472	25
 3-way	2002-473	25
 4-way	2002-474	25
 5-way	2002-475	25
 6-way	2002-476	25
 7-way	2002-477	25
 8-way	2002-478	25
 9-way	2002-479	25
 10-way	2002-480	25
 11-way	2002-481	25
 12-way	2002-482	25



Continuous jumper; insulated; I_N 25 A, light gray

 2-way	2002-400	25
---	----------	----

Continuous jumper; insulated; I_N 25 A; light gray

 1 to 3	2002-423	25
 1 to 4	2002-424	25

Continuous jumper; insulated; I_N 25 A, light gray

 3-way	2002-413	25
 5-way	2002-415	25

Technical Data

0.25 ... 2.5 (4) mm² ① | 22 ... 12 AWG

400 V / 6 kV / 3 ② | 250 V, 10 A ③

I_N 10 A ③

Terminal block width: 5.2 mm / 0.205 inch

10 ... 12 mm / 0.39 ... 0.47 inch

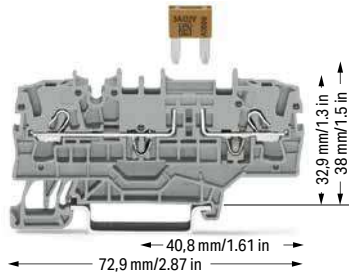

① Conductor range: 0.25 ... 4 mm² "s+f-st";
Push-in termination: 1 ... 4 mm² "s" and 1 ... 2.5 mm² "insulated ferrules, 12 mm"
Depending on the conductor characteristic, a conductor with a smaller cross section can also be inserted via push-in termination.

② 400 V = rated voltage
6 kV = rated impulse voltage
3 = pollution degree
(see Section 15)

③ Observe touch-proof protection for 42 V and higher voltages!
• 10 A (individual arrangement)
• 5 A (block arrangement)

Blade-style fuses are not offered by WAGO.

Please observe the application notes:
Jumpers, from page 182
Testing accessories, from page 177
Marking, from page 684

Approvals and corresponding ratings,
visit www.wago.com



Selecting the correct fuse cartridge is important for product safety within applications, as well as for fuse cartridge service life and reliability. Fuse cartridges can operate perfectly as protection (break-off point) if they are properly selected and used according to manufacturer specifications.

Nominal current ratings for fuse cartridges are defined differently in international standards.

This is why the recommended continuous current-carrying capacity of the fuses is a max. 80% of their nominal current according to DIN 72581/Part 3 (for a surrounding air temperature of 23°C).

With regard to product safety, fuse cartridges must generally be tested both under normal and faulty operating conditions within your application.

2-conductor fuse terminal block; for mini-automotive blade-style fuse; with test point; without blown fuse indication; with additional jumper slot
Electrical ratings are given by the fuse. Blade-style fuses: Observe touch-proof protection for 42 V and higher voltages!

Color	Item No.	Pack. Unit
○ gray	2002-1981	50

WMB Inline; plain; 1,500 WMB markers (5 mm)/reel; stretchable 5 ... 5.2 mm



white	2009-115	1
-------	----------	---

Marking strip; plain; 11 mm wide; 50 m reel



white	2009-110	1
-------	----------	---

WMB marker card; white; 10 strips with 10 markers/card; stretchable 5 ... 5.2 mm



plain	793-5501	5
-------	----------	---

Double-deck marker carrier; pivoting



gray	2002-121	50 (25)
------	----------	---------

Fused Disconnect Terminal Block with Pivoting Fuse Holder TOPJOB® S; for 5 x 20 mm Glass Cartridge Fuse

2.5 (4) mm²; 2002 Series

1

Technical Data	
0.25 ... 2.5 (4) mm ² ①	22 ... 12 AWG
250 V / 6 kV / 3 ②	250 V, 10 A ③
I _N 6,3 A	250 V, 10 A ④
Klemmenbreite 6,2 mm / 0.244 inch	
10 ... 12 mm / 0.39 ... 0.47 inch	

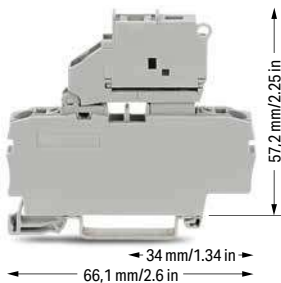

2-conductor fused disconnect terminal block with a pivoting fuse holder; for 5 x 20 mm glass cartridge fuse; without blown fuse indication
Electrical ratings are given by the fuse.

	Item No.	Pack. Unit
○ gray ⑤	2002-1611 ⑥	50

Technical Data	
0.25 ... 2.5 (4) mm ² ①	22 ... 12 AWG
250 V / 6 kV / 3 ②	250 V, 10 A ③
I _N 6,3 A	250 V, 10 A ④
Klemmenbreite 6,2 mm / 0.244 inch	
10 ... 12 mm / 0.39 ... 0.47 inch	

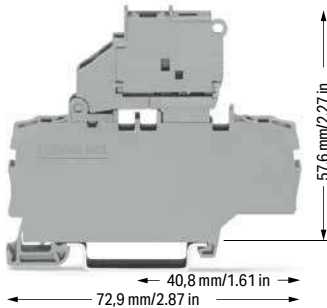

2-conductor fused disconnect terminal block with a pivoting fuse holder; with additional jumper slot; for 5 x 20 mm glass cartridge fuse; without blown fuse indication
Electrical ratings are given by the fuse.

	Item No.	Pack. Unit
○ gray ⑤	2002-1911 ⑥	50

Technical Data	
0.25 ... 2.5 (4) mm ² ①	22 ... 12 AWG
250 V / 6 kV / 3 ②	250 V, 10 A ③
I _N 6,3 A	250 V, 10 A ④
Klemmenbreite 6,2 mm / 0.244 inch	
10 ... 12 mm / 0.39 ... 0.47 inch	

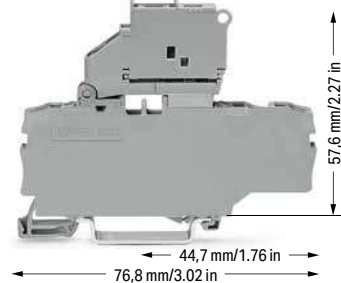

3-conductor fused disconnect terminal block with a pivoting fuse holder; for 5 x 20 mm glass cartridge fuse; without blown fuse indication
Electrical ratings are given by the fuse.

	Item No.	Pack. Unit
○ gray ⑤	2002-1711 ⑥	50

2-conductor fused disconnect terminal block with a pivoting fuse holder; for 5 x 20 mm glass cartridge fuse; with blown fuse indication by LED; gray
Electrical ratings are given by the fuse and blown fuse indication. Leakage current in case of a blown fuse: LED 2 mA

○ 12 ... 30 V ⑤	2002-1611/1000-541 ⑥ ④	50
○ 30 ... 65 V ⑤	2002-1611/1000-542 ⑥ ⑤	50
○ 120 V ⑤	2002-1611/1000-867 ⑥	50
○ 230 V ⑤	2002-1611/1000-836 ⑥	50

2-conductor fused disconnect terminal block with a pivoting fuse holder; with additional jumper slot; for 5 x 20 mm glass cartridge fuse; with blown fuse indication by LED; gray
Electrical ratings are given by the fuse and blown fuse indication. Leakage current in case of a blown fuse: LED 2 mA

○ 12 ... 30 V ⑤	2002-1911/1000-541 ⑥ ④	50
○ 30 ... 65 V ⑤	2002-1911/1000-542 ⑥ ⑤	50
○ 120 V ⑤	2002-1911/1000-867 ⑥	50
○ 230 V ⑤	2002-1911/1000-836 ⑥	50

3-conductor fused disconnect terminal block with a pivoting fuse holder; for 5 x 20 mm glass cartridge fuse; with blown fuse indication by LED; gray
Electrical ratings are given by the fuse and blown fuse indication. Leakage current in case of a blown fuse: LED 2 mA

○ 12 ... 30 V ⑤	2002-1711/1000-541 ⑥ ④	50
○ 30 ... 65 V ⑤	2002-1711/1000-542 ⑥ ⑤	50
○ 120 V ⑤	2002-1711/1000-867 ⑥	50
○ 230 V ⑤	2002-1711/1000-836 ⑥	50

Accessories; item-specific

Push-in type wire jumper; insulated; 1.5 mm² conductor cross-section; I_N 18 A

	L = 60 mm	2009-412	100 (10)
	L = 110 mm	2009-414	100 (10)
	L = 250 mm	2009-416	100 (10)

Other terminal blocks with the same profile:

Through	2002-1601	Page 107
---------	-----------	----------

Other terminal blocks with the same profile:

Through	2002-1901	Page 113
---------	-----------	----------

Other terminal blocks with the same profile:

Through	2002-1701	Page 109
---------	-----------	----------

Accessories; 2002 Series

Appropriate marking systems: WMB/WMB Inline/Marking strips

End plate for fuse terminal blocks; 2 mm thick

	orange	2002-992	100 (25)
	gray	2002-991	100 (25)

Insulation stop; 5 pcs/strip; 0.25 ... 0.5 mm²

	light gray	2002-171	200 (25)
--	------------	----------	----------

Insulation stop; 5 pcs/strip; 0.75 ... 1 mm²

	dark gray	2002-172	200 (25)
--	-----------	----------	----------

Protective warning marker; with black high-voltage symbol; for 5 terminal blocks

	yellow	2002-115	100 (25)
--	--------	----------	----------

Push-in type jumper bar; insulated; I_N 32 A; light gray

	2-way	2004-402	25
	3-way	2004-403	25
	4-way	2004-404	25
	5-way	2004-405	25
	6-way	2004-406	25
	7-way	2004-407	25
	8-way	2004-408	25
	9-way	2004-409	25
	10-way	2004-410	25

Push-in type jumper bar; insulated; I_N 32 A; light gray

	1 to 3	2004-433	25
	1 to 4	2004-434	25
	1 to 5	2004-435	25
	1 to 6	2004-436	25
	1 to 7	2004-437	25
	1 to 8	2004-438	25
	1 to 9	2004-439	25
	1 to 10	2004-440	25

Interlocking link; mechanically locks multiple links; 1 m long

	transparent	210-254	1
--	-------------	---------	---

Marking strip; plain; 11 mm wide; 50 m reel

	white	2009-110	1
--	-------	----------	---

WMB marker card; white; 10 strips with 10 markers/card; stretchable 5 ... 5.2 mm

	plain	793-5501	5
--	-------	----------	---

Technical Data

0.25 ... 2.5 (4) mm ² ①	22 ... 12 AWG
250 V / 6 kV / 3 ②	250 V, 10 A ③
I _n 6,3 A	250 V, 10 A ④
Klemmenbreite 6,2 mm / 0.244 inch	
10 ... 12 mm / 0.39 ... 0.47 inch	



4-conductor fused disconnect terminal block with a pivoting fuse holder; for 5 x 20 mm glass cartridge fuse; without blown fuse indication
Electrical ratings are given by the fuse.

	Item No.	Pack. Unit
○ gray ⑤	2002-1811 ④	50

4-conductor fused disconnect terminal block with a pivoting fuse holder; for 5 x 20 mm glass cartridge fuse; with blown fuse indication by LED; gray
Electrical ratings are given by the fuse and blown fuse indication. Leakage current in case of a blown fuse: LED 2 mA

○ 12 ... 30 V ⑥	2002-1811/1000-541 ③ ④	50
○ 30 ... 65 V ⑥	2002-1811/1000-542 ③ ⑤	50
○ 120 V ⑥	2002-1811/1000-867 ③	50
○ 230 V ⑥	2002-1811/1000-836 ③	50

Other terminal blocks with the same profile:

Through	2002-1801	Page 111
---------	-----------	----------

- Conductor range: 0.25 ... 4 mm² "s+f-st";
Push-in termination: 1 ... 4 mm² "s" and 1 ... 2.5 mm² "insulated ferrules, 12 mm"
Depending on the conductor characteristic, a conductor with a smaller cross section can also be inserted via push-in termination.
- 250 V = rated voltage
6 kV = rated impulse voltage
3 = pollution degree
(see Section 15)
- Terminal blocks with an Ex mark are suitable for Ex e II applications.
250 V; 6.3 A
(see Section 15)
- 30 V / 0,8 kV / 3
- 65 V / 1,5 kV / 3

Please observe the application notes:
Jumpers, from page 185
Marking, from page 684

A protective warning marker and an insulation stop must be applied individually. Due to the 6.2 mm width of fused disconnect terminal blocks with end plates, 2004 Series Push-In Type Jumper Bars must be used.

Approvals and corresponding ratings, visit www.wago.com

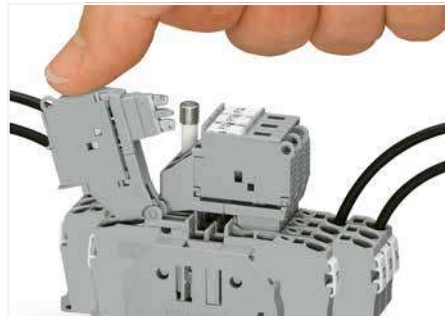

Fused disconnect terminal block with a pivoting fuse holder – pivoting the fuse holder into the locked open position.



Fused disconnect terminal block with a pivoting fuse holder – fuse replacement: Open the cover to replace the fuse.



Fuse terminal blocks with a width of 6.2 mm can be assembled adjacently. If there is no adjacent fuse terminal block at the end of the assembly, an end plate must be used.

Glass cartridge fuse 5 x 20

Series Item No.	Overload and short circuit protection		Short circuit protection only	
	Individual argmt.	Group argmt.	Individual argmt.	Group argmt.
Fuse terminal blocks				
2002-1611				
2002-1711	1.6 W	1.6 W	2.5 W	2.5 W
2002-1811				
2002-1611/.....				
2002-1711/.....	1.6 W	1.6 W	2.5 W	2.5 W
2002-1811/.....				

When selecting glass cartridge fuses, make sure that the maximum power loss listed below is not exceeded. The power loss is determined according to IEC or EN 60947-7-3/VDE 0611-6 at 23°C. The temperature rise of the terminal blocks must be checked according to their application and mounting. Higher ambient temperatures represent an additional impact on fuse cartridges. Therefore, in such applications, the rated current must be reduced if necessary. More details are available from the manufacturers.

Glass cartridge fuses 5 x 20

Series Item No.	Overload and short circuit protection		Short circuit protection only	
	Individual argmt.	Group argmt.	Individual argmt.	Group argmt.
Fuse terminal blocks				
2002-1911	1.6 W	1.6 W	2.5 W	2.5 W
2002-1911/.....	1.6 W	1.6 W	2.5 W	2.5 W

When selecting glass cartridge fuses, make sure that the maximum power loss listed below is not exceeded. The power loss is determined according to IEC or EN 60947-7-3/VDE 0611-6 at 23°C. The temperature rise of the terminal blocks must be checked according to their application and mounting. Higher ambient temperatures represent an additional impact on fuse cartridges. Therefore, in such applications, the rated current must be reduced if necessary. More details are available from the manufacturers.

Disconnect Terminal Block, Ground Conductor Disconnect Terminal Block, Carrier Terminal Block TOPJOB® S; with Push-Button 6 (10) mm²; 2206 Series

1

Technical Data	
0.5 ... 6 (10) mm ² ①	20 ... 8 AWG
800 V / 8 kV / 3 ②	
I _N 30 A	
Terminal block width: 7.5 mm / 0.295 inch	
13 ... 15 mm / 0.51 ... 0.59 inch	

Technical Data	
0.5 ... 6 (10) mm ² ①	20 ... 8 AWG
Terminal block width: 15 mm / 0.591 inch	
13 ... 15 mm / 0.51 ... 0.59 inch	

Technical Data	
0.5 ... 6 (10) mm ² ①	20 ... 8 AWG
800 V / 8 kV / 3 ②	
I _N 30 A	
Terminal block width: 7.5 mm / 0.295 inch	
13 ... 15 mm / 0.51 ... 0.59 inch	

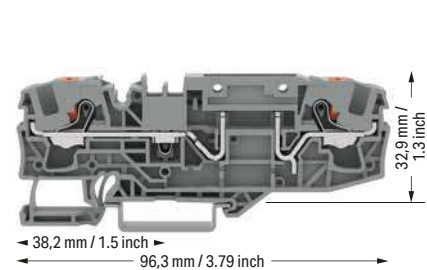
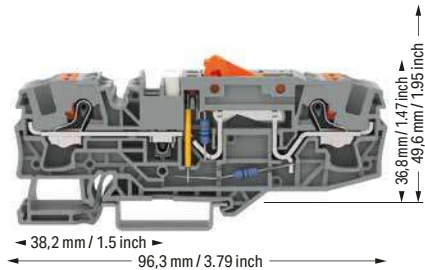
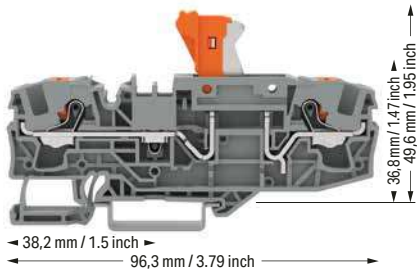

2-conductor disconnect terminal block; with push-button; with pivoting knife disconnect; with test point; with orange disconnect link

Color	Item No.	Pack. Unit
gray	2206-1671	25
blue	2206-1674	25
orange	2206-1672	25
red	2206-1673	25
black	2206-1675	25

Ground conductor disconnect terminal block; with push-button; with test point; with orange disconnect link; gray

	Item No.	Pack. Unit
○ 24 V	2206-1671/1000-848	12
○ 48 V	2206-1671/1000-849	12
○ 120 V	2206-1671/1000-850	12
○ 230 V	2206-1671/1000-851	12

2-conductor carrier terminal block; with push-button

Color	Item No.	Pack. Unit
gray	2206-1661	25
blue	2206-1664	25
orange	2206-1662	25
red	2206-1663	25

Other terminal blocks with the same profile:
Fuse 2206-1611 Page 122

Other terminal blocks with the same profile:
Fuse 2206-1611 Page 122

Other terminal blocks with the same profile:
Fuse 2206-1611 Page 122

Accessories; item-specific

Push-in type jumper bar; insulated; I_N 41 A; light gray

	2-way	2006-402	25
	3-way	2006-403	25
	4-way	2006-404	25
	5-way	2006-405	25

Accessories; item-specific

Push-in type jumper bar; insulated; I_N 41 A; light gray

	2-way	2006-402	25
--	-------	----------	----

Accessories; item-specific

Push-in type jumper bar; insulated; I_N 41 A; light gray

	2-way	2006-402	25
	3-way	2006-403	25
	4-way	2006-404	25
	5-way	2006-405	25

Push-in type jumper bar; insulated; I_N 41 A; light gray

	1 to 3	2006-433	25
	1 to 4	2006-434	25
	1 to 5	2006-435	25

Push-in type jumper bar; insulated; I_N 41 A; light gray

	1 to 3	2006-433	25
	1 to 4	2006-434	25
	1 to 5	2006-435	25

Star point jumper; insulated; I_N = I_N terminal block; light gray

	1-3-5	2006-405/011-000	25
--	-------	------------------	----

Star point jumper; insulated; I_N = I_N terminal block; light gray

	1-3-5	2006-405/011-000	25
--	-------	------------------	----

Disconnect plug for carrier terminal blocks; suitable when using a carrier terminal block as disconnect terminal block

	orange	2006-401	100 (25)
--	--------	----------	----------

Blind plug for carrier terminal block; indicates a disconnection

	red	2006-451	100 (25)
--	-----	----------	----------

Accessories; 2206 Series

End and intermediate plate; 1 mm thick

	orange	2006-1692	100 (25)
	gray	2006-1691	100 (25)

Appropriate marking systems: WMB/Marking strips

Marking strip; plain; 11 mm wide; 50 m reel

	white	2009-110	1
--	-------	----------	---

Double-deck marker carrier; pivoting

	gray	2002-121	50 (25)
--	------	----------	---------

Lockout cap; for conductor entry and operating slot

	gray	2006-191	25
--	------	----------	----

WMB marker card; white; 10 strips with 10 markers/card; stretchable 5 ... 5.2 mm

	plain	793-5501	5
--	-------	----------	---

❶ Conductor range: 0.5 ... 10 mm² "s+f-st";
Push-in termination: 2.5 ... 10 mm² "s" and
2.5 ... 6 mm² "insulated ferrules; 12 mm"
Depending on the conductor characteristic, a conductor
with a smaller cross section can also be inserted
via push-in termination.

❷ 800 V = rated voltage
8 kV = rated impulse voltage
3 = pollution degree
(see Section 15)

The 2 mm test slot is only approved for high impedance
measurement up to max. 100 mA.

Please observe the application notes:
Jumpers, from page 185
Marking, from page 684

Approvals and corresponding ratings,
visit www.wago.com

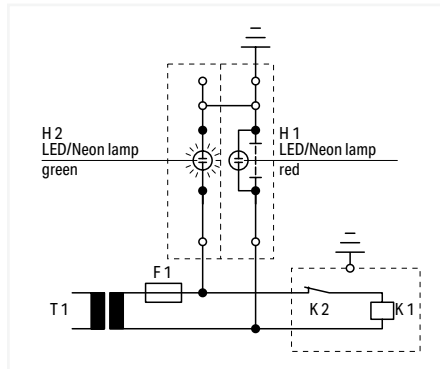

Operation

Slide link closed, auxiliary circuit grounded, green LED/
neon lamp illuminates.

IEC 60204/DIN VDE 0113 "Safety of machinery – Electrical
equipment of machines – Part 1: General requirements,"
Section 9.4.3.1:

Ground faults on control circuits must not cause unintentional
starting, hazardous movements, or prevent stopping
of the machine.

In order to fulfill this requirement, a connection to the protective
bonding circuit must be provided in accordance
with Section 8.2. and the devices must be connected as
described in Section 9.1.4. Control circuits fed from a
transformer and not connected to the protective bonding
circuit must be provided with an insulation monitoring
device (e.g., residual current device), which either indicates
a ground fault or interrupts the circuit automatically
after a ground fault.

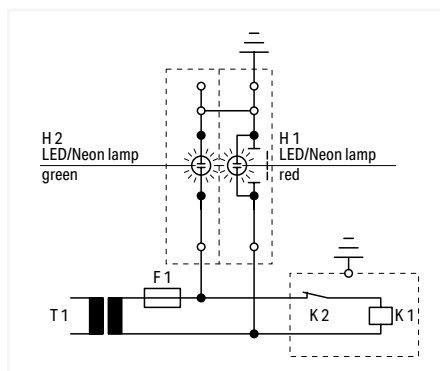

Test condition – no grounding

Slide link open, auxiliary circuit not grounded.

In the case of electronic circuits, connecting one side of
the control circuit to the protective bonding circuit in
accordance with Section 9.1.4 can prevent unintentional
operation. When this does not help, or if due to other reasons
that electronic circuits cannot be connected to the
protective bonding circuit, other measures must be taken
to achieve the same level of safety.

Multipole control switches that interrupt all live conductors
must be used where the control circuit is directly connected
between the phase conductors of the supply or
between a phase conductor and a neutral conductor,
which is either not grounded or grounded through a high
impedance. This is required for starting or stopping
machine functions, which can cause a hazardous situation
including: damaging the machine or halting work in progress
in the event of unintentional starting or failure to stop.

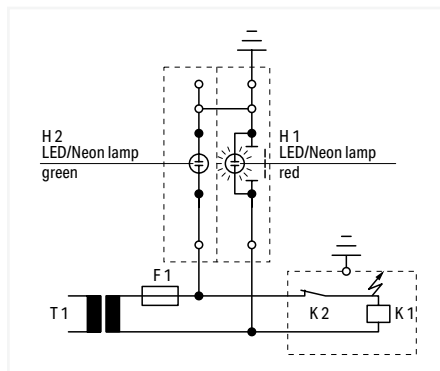

Test condition – grounding

Slide link open, auxiliary circuit not grounded,
red LED/neon lamp illuminates.

Fuse Terminal Block TOPJOB® S; with Push-Button; for Automotive Blade-Style Fuse 6 (10) mm²; 2206 Series

1

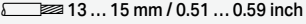
Technical Data	
0.5 ... 6 (10) mm ² ①	20 ... 8 AWG
500 V / 6 kV / 3 ②	
I _N 25 A (30 A) ③	
Terminal block width: 7.5 mm / 0.295 inch	
 13 ... 15 mm / 0.51 ... 0.59 inch	

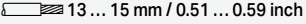
Technical Data	
0.5 ... 6 (10) mm ² ①	20 ... 8 AWG
500 V / 6 kV / 3 ②	
I _N 25 A (30 A) ③	
Terminal block width: 7.5 mm / 0.295 inch	
 13 ... 15 mm / 0.51 ... 0.59 inch	

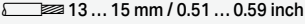
Technical Data	
0.5 ... 6 (10) mm ² ①	20 ... 8 AWG
500 V / 6 kV / 3 ②	
I _N 25 A (30 A) ③	
Terminal block width: 7.5 mm / 0.295 inch	
 13 ... 15 mm / 0.51 ... 0.59 inch	

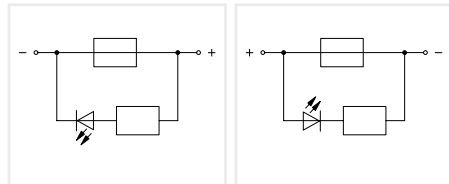
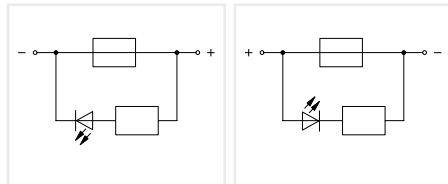
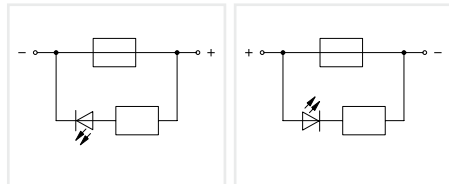
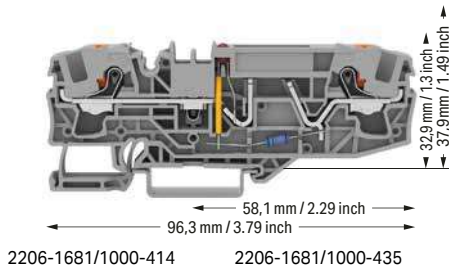
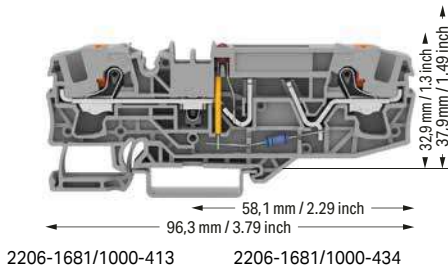
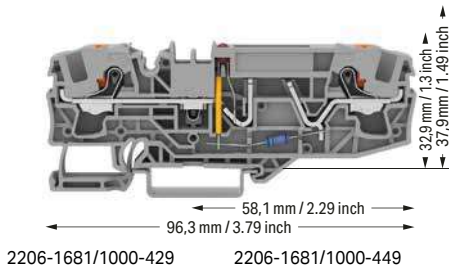

2-conductor fuse terminal block; with push-button; for automotive blade-style fuses; with test point; with blown fuse indication by LED; 12 V; LED power consumption: 4.8 mA
Electrical ratings are given by the fuse and blown fuse indication. Blade-style fuses: Observe touch-proof protection for 42 V and higher voltages!

2-conductor fuse terminal block; with push-button; for automotive blade-style fuses; with test point; with blown fuse indication by LED; 24 V; LED power consumption: 4.8 mA
Electrical ratings are given by the fuse and blown fuse indication. Blade-style fuses: Observe touch-proof protection for 42 V and higher voltages!

2-conductor fuse terminal block; with push-button; for automotive blade-style fuses; with test point; with blown fuse indication by LED; 48 V; LED power consumption: 4.8 mA
Electrical ratings are given by the fuse and blown fuse indication. Blade-style fuses: Observe touch-proof protection for 42 V and higher voltages!

Color	Item No.	Pack. Unit
○ gray	2206-1681/1000-429	25
○ gray	2206-1681/1000-449	25

Farbe	Item No.	Pack. Unit
○ gray	2206-1681/1000-413	25
○ gray	2206-1681/1000-434	25

Color	Item No.	Pack. Unit
○ gray	2206-1681/1000-414	25
○ gray	2206-1681/1000-435	25

Other terminal blocks with the same profile:
Disconnect **2206-1671** Page 118

Accessories; 2206 Series

End and intermediate plate; 1 mm thick			
	orange	2006-1692	100 (25)
	gray	2006-1691	100 (25)

Push-in type jumper bar; insulated; I _N 41 A; light gray			
	2-way	2006-402	25
	3-way	2006-403	25
	4-way	2006-404	25
	5-way	2006-405	25

Push-in type jumper bar; insulated; I _N 41 A; light gray			
	1 to 3	2006-433	25
	1 to 4	2006-434	25
	1 to 5	2006-435	25

Appropriate marking systems: WMB/Marking strips

Marking strip; plain; 11 mm wide; 50 m reel			
	white	2009-110	1

WMB marker card; white; 10 strips with 10 markers/card; stretchable 5 ... 5.2 mm			
	plain	793-5501	5

Double-deck marker carrier; pivoting			
	gray	2002-121	50 (25)

PUSH-IN CAGE CLAMP®

Technical Data

0.5 ... 6 (10) mm² ① | 20 ... 8 AWG
 500 V / 6 kV / 3 ②
 I_N 25 A (30 A)
 Terminal block width: 7.5 mm / 0.295 inch
 13 ... 15 mm / 0.51 ... 0.59 inch

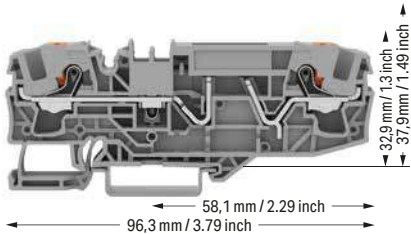

① Conductor range: 0.5 ... 10 mm² "s+f-st"; Push-in termination: 2.5 ... 10 mm² "s" and 2.5 ... 6 mm² "insulated ferrules; 12 mm" Depending on the conductor characteristic, a conductor with a smaller cross section can also be inserted via push-in termination.

② 500 V = rated voltage
 6 kV = rated impulse voltage
 3 = pollution degree (see Section 15)

③ LED power consumption: 4.8 mA
 The 2 mm test slot is only approved for high impedance measurement up to max. 100 mA.

Blade-style fuses are not offered by WAGO. Thermal automotive circuit breakers are not offered by WAGO. WAGO recommends automotive circuit breakers from ETA.

Please observe the application notes: Jumpers, from page 185
 Marking, from page 684

Approvals and corresponding ratings, visit www.wago.com

2-conductor fuse terminal block; with push-button; for automotive blade-style fuses; with test point; without blown fuse indication
 Electrical ratings are given by the fuse. Blade-style fuses: Observe touch-proof protection for 42 V and higher voltages!

Color	Item No.	Pack. Unit
○ gray	2206-1681	25

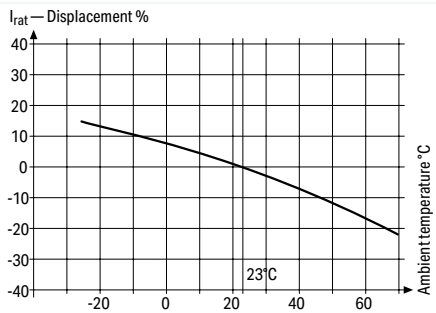

Application Notes for Use of Fuse Terminal Blocks
 Nominal current ratings for fuse cartridges are defined differently in international standards.

This is why the recommended continuous current-carrying capacity of the fuses is a max. 80% of their nominal current according to DIN 72581/Part 3 (for an ambient temperature of 23°C).

Selecting the correct fuse cartridge is important for product safety within applications, as well as for fuse cartridge service life and reliability. Fuse cartridges will only operate perfectly as protection components (break-off point) if they are properly selected and used as intended (i.e., according to the state of the technology and valid specifications, as well as data sheet characteristics), according to basic safety requirements (i.e., persons, animals and property must be protected against hazards).

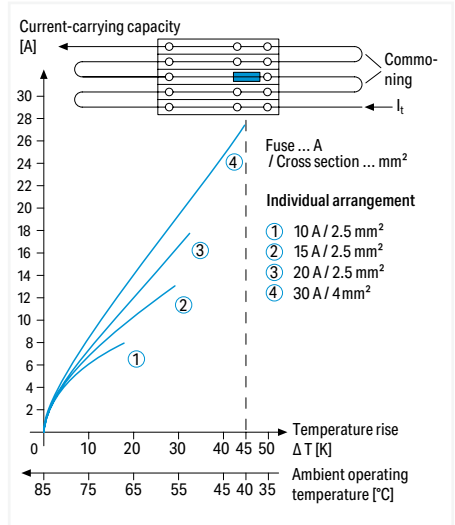

Application Notes for Use of Fuse Terminal Blocks
 Diagram: "Individual Arrangement"

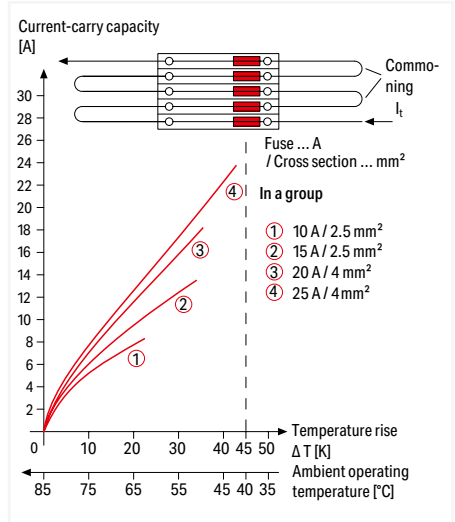

Application Notes for Use of Fuse Terminal Blocks
 Diagram: "Block Arrangement"

Information from the mini-automotive, blade-type fuse manufacturers

Derating T _{amb} / °C	%	F _T
-25	14	0.877
-20	13	0.885
-15	12	0.893
-10	11	0.901
-5	10	0.909
0	9	0.917
5	8	0.926
10	6	0.943
15	4	0.962
20	2	0.980
23	0	1.000
30	-2	1.020
35	-4	1.042
40	-6	1.064
45	-8	1.087
50	-10	1.111
55	-13	1.149
60	-16	1.190
65	-19	1.235
70	-22	1.282

Concerning product safety, fuse cartridges must generally be tested under both normal and faulty operating conditions within your application.

PUSH-IN CAGE CLAMP®

Fused Disconnect Terminal Block with a Pivoting Fuse Holder TOPJOB® S; with Push-Button; for 5 x 20 mm, 5 x 30 mm and ¼" x 1¼" Glass Cartridge Fuses 6 (10) mm²; 2206 Series

1

Technical Data	
0.5 ... 6 (10) mm ² ①	20 ... 8 AWG
800 V / 8 kV / 3 ②	
I _N 10 A	
Terminal block width: 7.5 mm / 0.295 inch	
13 ... 15 mm / 0.51 ... 0.59 inch	

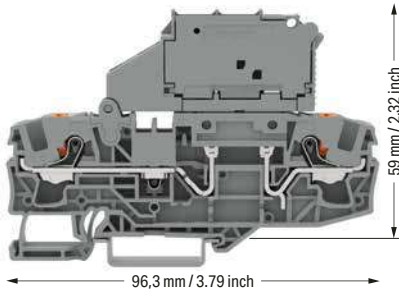

2-conductor fused disconnect terminal block with a pivoting fuse holder; with push-button; without blown fuse indication
Electrical ratings are given by the fuse.

for 5 x 20 mm glass cartridge fuse

Color	Item No.	Pack. Unit
gray	2206-1611	25
orange	2206-1612	25
black	2206-1615	25

for 5 x 30 mm glass cartridge fuse

gray	2206-1621	25
blue	2206-1624	25
orange	2206-1622	25

for ¼" x 1¼" glass cartridge fuse

gray	2206-1631	25
------	-----------	----

Other terminal blocks with the same profile:		
Disconnect	2206-1671	Page 118

Technical Data	
0.5 ... 6 (10) mm ² ①	20 ... 8 AWG
800 V / 8 kV / 3 ②	
I _N 10 A	
Terminal block width: 7.5 mm / 0.295 inch	
13 ... 15 mm / 0.51 ... 0.59 inch	

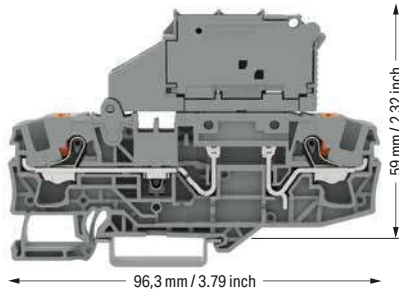

2-conductor fused disconnect terminal block with a pivoting fuse holder; with push-button; with blown fuse indication by LED; gray
Electrical ratings are given by the fuse and blown fuse indication. Leakage current in case of a blown fuse: LED 2 mA

for 5 x 20 mm glass cartridge fuse

	Item No.	Pack. Unit
12 ... 30 V	2206-1611/1000-541 ③	25
30 ... 65 V	2206-1611/1000-542 ④	25
120 V	2206-1611/1000-867	25
230 V	2206-1611/1000-836	25

for 5 x 30 mm glass cartridge fuse

12 ... 30 V	2206-1621/1000-541 ③	25
30 ... 65 V	2206-1621/1000-542 ④	25
230 V	2206-1621/1000-836	25
380 ... 500 V	2206-1621/1000-859	25

for ¼" x 1¼" glass cartridge fuse

12 ... 30 V	2206-1631/1000-541 ③	25
30 ... 65 V	2206-1631/1000-542 ④	25
120 V	2206-1631/1000-867	25
230 V	2206-1631/1000-836	25
380 ... 500 V	2206-1631/1000-859	25

Other terminal blocks with the same profile:		
Disconnect	2206-1671	Page 118

Accessories; 2206 Series

Appropriate marking systems: WMB/Marking strips

End and intermediate plate; 1 mm thick		
orange	2006-1692	100 (25)
gray	2006-1691	100 (25)

End plate for fuse terminal blocks; 2 mm thick		
orange	2006-992	100 (25)
gray	2006-991	100 (25)

Push-in type jumper bar; insulated; I _N 41 A; light gray		
2-way	2006-402	25
3-way	2006-403	25
4-way	2006-404	25
5-way	2006-405	25

Push-in type jumper bar; insulated; I _N 41 A; light gray		
1 to 3	2006-433	25
1 to 4	2006-434	25
1 to 5	2006-435	25

Star point jumper; insulated; I _N = I _N terminal block; light gray		
1-3-5	2006-405/011-000	25

Test plug; with 500 mm cable; 2 mm Ø; max. 42 V		
red	210-136	50 (1)

WMB marker card; white; 10 strips with 10 markers/card; stretchable 5 ... 5.2 mm		
plain	793-5501	5

① Conductor range: 0.5 ... 10 mm² "s+f-st"; Push-in termination: 2.5 ... 10 mm² "s" and 2.5 ... 6 mm² "insulated ferrules; 12 mm"
Depending on the conductor characteristic, a conductor with a smaller cross section can also be inserted via push-in termination.

② 800 V = rated voltage
8 kV = rated impulse voltage
3 = pollution degree (see Section 15)

③ 30 V / 0,8 kV / 3

④ 65 V / 1,5 kV / 3

The 2 mm test slot is only approved for high impedance measurement up to max. 100 mA.

Please observe the application notes:
Jumpers, from page 185
Marking, from page 684

Approvals and corresponding ratings, visit www.wago.com



Fused Disconnect Terminal Block with a Pivoting Fuse Holder
Pivot the fuse holder into the locked open position.



Fused Disconnect Terminal Block with a Pivoting Fuse Holder
Fuse replacement:
Open the cover to replace the fuse.

Fused Disconnect Terminal Block with a Pivoting Fuse Holder TOPJOB® S; with Push-Button; for 1/4" x 1 1/4" Glass Cartridge Fuses

6 (10) mm²; 2206 Series

Technical Data

0.5 ... 6 (10) mm² ① | 20 ... 8 AWG
 800 V / 8 kV / 3 ②
 I_N 10 A
 Terminal block width: 10.4 mm / 0.409 inch
 13 ... 15 mm / 0.51 ... 0.59 inch

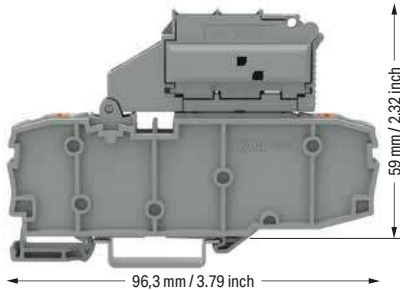

Fused disconnect terminal block with a pivoting fuse holder and end plate; with push-button; without blown fuse indication
 Electrical ratings are given by the fuse.

for 1/4" x 1 1/4" glass cartridge fuse

Color	Item No.	Pack. Unit
○ gray	2206-1631/099-000	25

Technical Data

0.5 ... 6 (10) mm² ① | 20 ... 8 AWG
 800 V / 8 kV / 3 ②
 I_N 10 A
 Terminal block width: 10.4 mm / 0.409 inch
 13 ... 15 mm / 0.51 ... 0.59 inch

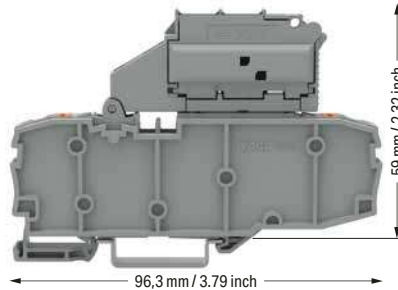

Fused disconnect terminal block with a pivoting fuse holder and end plate; with push-button; with blown fuse indication by LED; gray
 Electrical ratings are given by the fuse and blown fuse indication. Leakage current in case of a blown fuse: LED 2 mA

for 1/4" x 1 1/4" glass cartridge fuse

	Item No.	Pack. Unit
○ 12 ... 30 V	2206-1631/1099-541 ③	25
○ 30 ... 65 V	2206-1631/1099-542 ④	25
○ 120 V	2206-1631/1099-867	25
○ 230 V	2206-1631/1099-836	25
○ 380 ... 500 V	2206-1631/1099-859	25

Other terminal blocks with the same profile:

Disconnect 2206-1671 Page 118

Other terminal blocks with the same profile:

Disconnect 2206-1671 Page 118

Accessories; 2206 Series

Appropriate marking systems: WMB/Marking strips

End plate for fuse terminal blocks; 2 mm thick

	orange	2006-992	100 (25)
	gray	2006-991	100 (25)

Push-in type jumper bar; insulated; I_N 41 A; light gray

	2-way	2006-402	25
	3-way	2006-403	25
	4-way	2006-404	25
	5-way	2006-405	25

Star point jumper; insulated; I_N = I_N terminal block; light gray

	1-3-5	2002-405/011-000	25
---	-------	------------------	----

Test plug; with 500 mm cable; 2 mm Ø; max. 42 V

	red	210-136	50 (1)
---	-----	---------	--------

WMB marker card; white; 10 strips with 10 markers/card; stretchable 5 ... 5.2 mm

	plain	793-5501	5
---	-------	----------	---

① Conductor range: 0.5 ... 10 mm² "s+f-st";
 Push-in termination: 2.5 ... 10 mm² "s" and
 2.5 ... 6 mm² "insulated ferrules; 12 mm"
 Depending on the conductor characteristic, a conductor
 with a smaller cross section can also be inserted
 via push-in termination.

② 800 V = rated voltage
 8 kV = rated impulse voltage
 3 = pollution degree
 (see Section 15)

③ 30 V / 0,8 kV / 3

④ 65 V / 1,5 kV / 3

The 2 mm test slot is only approved for high impedance
 measurement up to max. 100 mA.

Please observe the application notes:
 Jumpers, from page 185
 Marking, from page 684

Approvals and corresponding ratings,
 visit www.wago.com

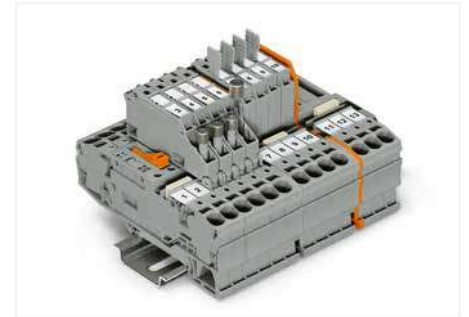



Pivoting fuse holder with spare fuse holder

Disconnect Terminal Block, Ground Conductor Disconnect Terminal Block, Carrier Terminal Block, Through Terminal Block TOPJOB® S 6 (10) mm²; 2006 Series

1

Technical Data	
0.5 ... 6 (10) mm ² ①	20 ... 8 AWG
800 V / 8 kV / 3 ②	600 V, 30 A ③
I _N 30 A	600 V, 30 A ④
Terminal block width: 7.5 mm / 0.295 inch	
 13 ... 15 mm / 0.51 ... 0.59 inch	

Technical Data	
0.5 ... 6 (10) mm ² ①	20 ... 8 AWG
Terminal block width: 7.5 mm / 0.295 inch	
 13 ... 15 mm / 0.51 ... 0.59 inch	

Technical Data	
0.5 ... 6 (10) mm ² ①	20 ... 8 AWG
800 V / 8 kV / 3 ②	600 V, 30 A ③
I _N 30 A	600 V, 30 A ④
Terminal block width: 7.5 mm / 0.295 inch	
 13 ... 15 mm / 0.51 ... 0.59 inch	

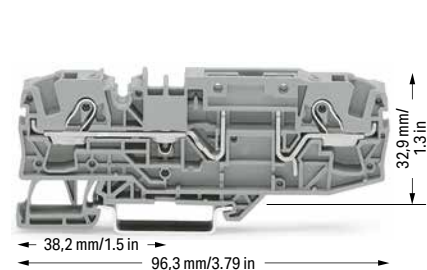
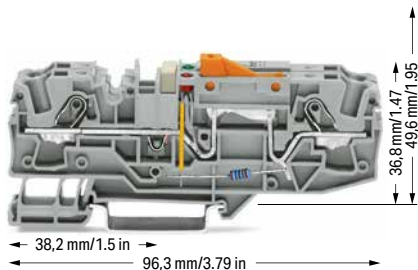
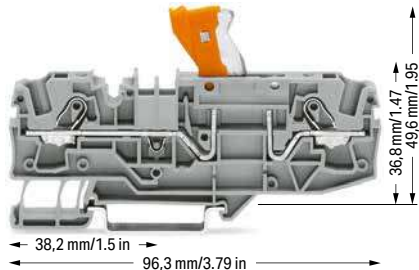

2-conductor disconnect terminal block; with test point; orange disconnect link

Color	Item No.	Pack. Unit
○ gray	2006-1671	25
● blue	2006-1674	25

Ground conductor disconnect terminal block; with test point; orange disconnect link; gray

	Item No.	Pack. Unit
○ 24 V	2006-1671/1000-848	12
○ 48 V	2006-1671/1000-849	12
○ 120 V	2006-1671/1000-850	12
○ 230 V	2006-1671/1000-851	12





2-conductor carrier terminal block; with test point

Color	Item No.	Pack. Unit
○ gray	2006-1661	25
● blue	2006-1664	25





Other terminal blocks with the same profile:		
Through	2006-1601	Page 125



Other terminal blocks with the same profile:		
Through	2006-1601	Page 125



Other terminal blocks with the same profile:		
Through	2006-1601	Page 125

Accessories; item-specific			
Push-in type jumper bar; insulated; I _N 41 A; light gray			
	2-way	2006-402	25
	3-way	2006-403	25
	4-way	2006-404	25
	5-way	2006-405	25

Accessories; item-specific			
Push-in type jumper bar; insulated; I _N 41 A; light gray			
	2-way	2006-402	25

Accessories; item-specific			
Push-in type jumper bar; insulated; I _N 41 A; light gray			
	2-way	2006-402	25
	3-way	2006-403	25
	4-way	2006-404	25
	5-way	2006-405	25

Push-in type jumper bar; insulated; I _N 41 A; light gray			
	1 to 3	2006-433	25
	1 to 4	2006-434	25
	1 to 5	2006-435	25

Push-in type jumper bar; insulated; I _N 41 A; light gray			
	1 to 3	2006-433	25
	1 to 4	2006-434	25
	1 to 5	2006-435	25

Star point jumper; insulated; I _N = I _N terminal block; light gray			
	1-3-5	2006-405/011-000	25

Star point jumper; insulated; I _N = I _N terminal block; light gray			
	1-3-5	2006-405/011-000	25

Disconnect plug for carrier terminal blocks; suitable when using a carrier terminal block as disconnect terminal block



	orange	2006-401	100 (25)
---	--------	----------	----------

Blind plug for carrier terminal block; indicates a disconnection

	red	2006-451	100 (25)
---	-----	----------	----------

Accessories; 2006 Series

Appropriate marking systems: WMB/Marking strips

End and intermediate plate; 1 mm thick			
	orange	2006-1692	100 (25)
	gray	2006-1691	100 (25)

Lockout cap; for conductor entry and operating slot			
	gray	2006-191	25

Protective warning marker; with black high-voltage symbol; for 5 terminal blocks			
	yellow	2006-115	100 (25)

PUSH-IN CAGE CLAMP®

1

Technical Data

0.5 ... 6 (10) mm ² ①	20 ... 8 AWG
800 V / 8 kV / 3 ②	600 V, 30 A ③
I _N 30 A	600 V, 30 A ④
Terminal block width: 15 mm / 0.591 inch	
13 ... 15 mm / 0.51 ... 0.59 inch	

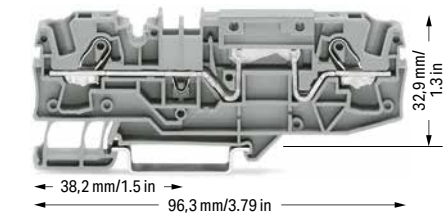

2-conductor through terminal block; with test point; same profile as 2-conductor disconnect terminal block

Color	Item No.	Pack. Unit
gray	2006-1601	25
blue	2006-1604	25

Other terminal blocks with the same profile:

Carrier	2006-1661	Page 124
Fuse	2006-1681	Page 127
Disconnect	2006-1671	Page 124

Accessories; item-specific

Push-in type jumper bar; insulated; I_N 41 A; light gray

	2-way	2006-402	25
	3-way	2006-403	25
	4-way	2006-404	25
	5-way	2006-405	25

Push-in type jumper bar; insulated; I_N 41 A; light gray

	1 to 3	2006-433	25
	1 to 4	2006-434	25
	1 to 5	2006-435	25

Star point jumper; insulated; I_N = I_N terminal block; light gray

	1-3-5	2006-405/011-000	25
--	-------	------------------	----

Double-deck marker carrier; pivoting

	gray	2002-121	50 (25)
--	------	----------	---------

① Conductor range: 0.5 ... 10 mm² "s+f-st"; Push-in termination: 2.5 ... 10 mm² "s" and 2.5 ... 6 mm² "insulated ferrules; 12 mm" Depending on the conductor characteristic, a conductor with a smaller cross section can also be inserted via push-in termination.

② 800 V = rated voltage
8 kV = rated impulse voltage
3 = pollution degree (see Section 15)

Please observe the application notes: Jumpers, from page 185
Marking, from page 684

Approvals and corresponding ratings, visit www.wago.com

IEC 60204/DIN VDE 0113 "Safety of machinery – Electrical equipment of machines – Part 1: General requirements," Section 9.4.3.1:

Ground faults on control circuits must not cause unintentional starting, hazardous movements, or prevent stopping of the machine.

In order to fulfill this requirement, a connection to the protective bonding circuit must be provided in accordance with Section 8.2 and the devices must be connected as described in Section 9.1.4. Control circuits fed from a transformer and not connected to the protective bonding circuit must be provided with an insulation monitoring device (e.g., residual current device), which either indicates a ground fault or interrupts the circuit automatically after a ground fault.

In the case of electronic circuits, the connection of one side of the control circuit to the protective bonding circuit in accordance with Section 9.1.4 can prevent unintentional operation. When this does not help, or if due to other reasons that electronic circuits cannot be connected to the protective bonding circuit, other measures must be taken to achieve the same level of safety.

Multipole control switches that interrupt all live conductors must be used where the control circuit is directly connected between the phase conductors of the supply or between a phase conductor and a neutral conductor, which is either not grounded or grounded through a high impedance. This is required for starting or stopping machine functions, which can cause a hazardous situation including: damaging the machine or halting work in progress in the event of unintentional starting or failure to stop.

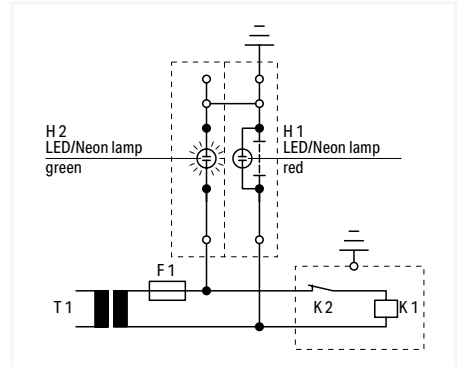

Operating condition
Slide link closed, auxiliary circuit grounded, green LED/neon lamp illuminates.

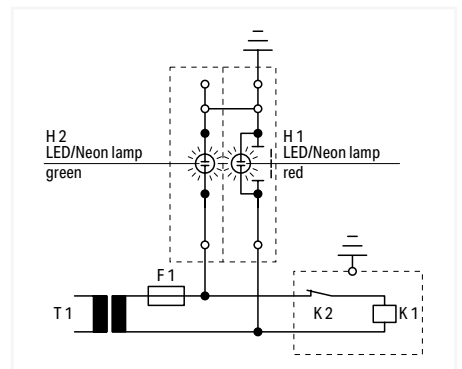

Test condition – no grounding
Slide link open, auxiliary circuit not grounded.

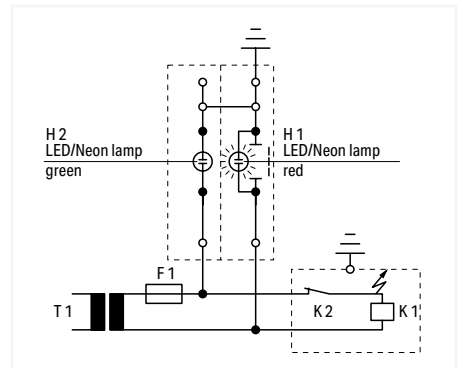

Test condition – grounding
Slide link open, auxiliary circuit not grounded, red LED/neon lamp illuminates.



Ground conductor disconnect terminal block – top view

Fuse Terminal Block for Automotive Blade-Style Fuse TOPJOB® S 6 (10) mm²; 2006 Series

1

Technical Data	
0.5 ... 6 (10) mm ² ①	20 ... 8 AWG
500 V / 6 kV / 3 ②	12 V, 30 A
I _N 25 A (30 A) ③	12 V, 30 A
Terminal block width: 7.5 mm / 0.295 inch	
13 ... 15 mm / 0.51 ... 0.59 inch	

Technical Data	
0.5 ... 6 (10) mm ² ①	20 ... 8 AWG
500 V / 6 kV / 3 ②	24 V, 30 A
I _N 25 A (30 A) ③	24 V, 30 A
Terminal block width: 7.5 mm / 0.295 inch	
13 ... 15 mm / 0.51 ... 0.59 inch	

Technical Data	
0.5 ... 6 (10) mm ² ①	20 ... 8 AWG
500 V / 6 kV / 3 ②	48 V, 30 A
I _N 25 A (30 A) ③	48 V, 30 A
Terminal block width: 7.5 mm / 0.295 inch	
13 ... 15 mm / 0.51 ... 0.59 inch	

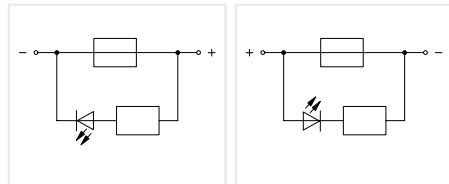
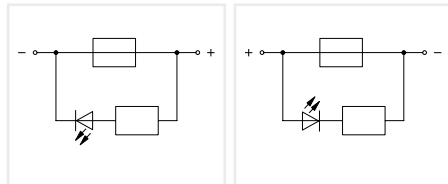
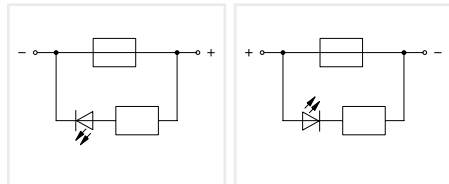
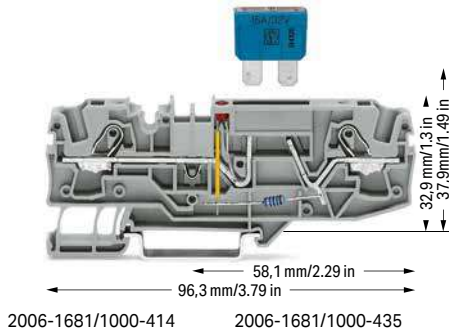
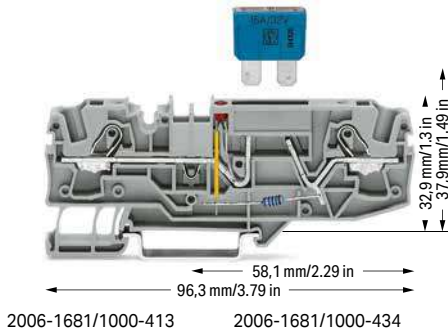
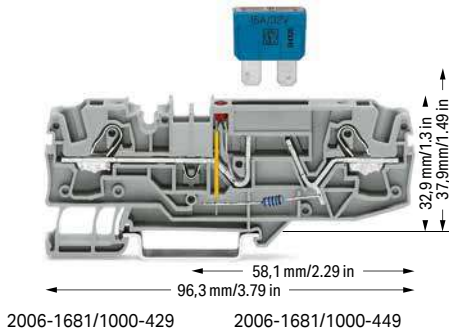

2-conductor fuse terminal block for automotive blade-style fuse; with test point; 12 V; with blown fuse indication by LED; LED power consumption: 4.8 mA
Electrical ratings are given by the fuse and blown fuse indication. Blade-style fuses: Observe touch-proof protection for 42 V and higher voltages!

2-conductor fuse terminal block for automotive blade-style fuse; with test point; 24 V; with blown fuse indication by LED; LED power consumption: 4.8 mA
Electrical ratings are given by the fuse and blown fuse indication. Blade-style fuses: Observe touch-proof protection for 42 V and higher voltages!

2-conductor fuse terminal block for automotive blade-style fuse; with test point; 48 V; with blown fuse indication by LED; LED power consumption: 4.8 mA
Electrical ratings are given by the fuse and blown fuse indication. Blade-style fuses: Observe touch-proof protection for 42 V and higher voltages!

Color	Item No.	Pack. Unit
○ gray	2006-1681/1000-429	25
○ gray	2006-1681/1000-449	25

Color	Item No.	Pack. Unit
○ gray	2006-1681/1000-413	25
○ gray	2006-1681/1000-434	25

Color	Item No.	Pack. Unit
○ gray	2006-1681/1000-414	25
○ gray	2006-1681/1000-435	25

Other terminal blocks with the same profile:
Through 2006-1601 Page 125

Accessories; 2006 Series

End and intermediate plate; 1 mm thick			
	orange	2006-1692	100 (25)
	gray	2006-1691	100 (25)

Appropriate marking systems: WMB/Marking strips			
Marking strip; plain; 11 mm wide; 50 m reel			
	white	2009-110	1

Push-in type jumper bar; insulated; I _N 41 A; light gray			
	2-way	2006-402	25
	3-way	2006-403	25
	4-way	2006-404	25
	5-way	2006-405	25

WMB marking card; white; 10 strips with 10 markers/card; 5 ... 5.2 mm stretchable			
	plain	793-5501	5

Push-in type jumper bar; insulated; I _N 41 A; light gray			
	1 to 3	2006-433	25
	1 to 4	2006-434	25
	1 to 5	2006-435	25

Double-deck marker carrier; pivoting			
	gray	2002-121	50 (25)

Protective warning marker; with black high-voltage symbol; for 5 terminal blocks			
	yellow	2006-115	100 (25)

Technical Data

0.5 ... 6 (10) mm ² ①	20 ... 8 AWG
500 V / 6 kV / 3 ②	600 V, 30 A ③
I _N 25 A (30 A)	600 V, 30 A ③
Terminal block width: 7.5 mm / 0.295 inch	
13 ... 15 mm / 0.51 ... 0.59 inch	

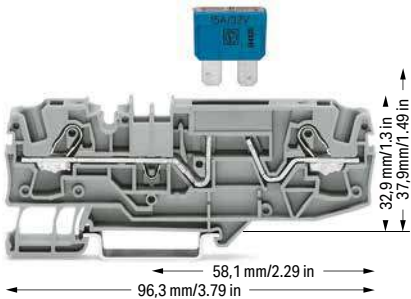

① Conductor range: 0.5 ... 10 mm² "s+f-st"; Push-in termination: 2.5 ... 10 mm² "s" and 2.5 ... 6 mm² "insulated ferrules; 12 mm" Depending on the conductor characteristic, a conductor with a smaller cross section can also be inserted via push-in termination.

② 500 V = rated voltage
6 kV = rated impulse voltage
3 = pollution degree (see Section 15)

③ LED power consumption: 4.8 mA

Blade-style fuses are not offered by WAGO.
Thermal automotive circuit breakers are not offered by WAGO.
WAGO recommends automotive circuit breakers from ETA.

Please observe the application notes:
Marking, from page 684

Approvals and corresponding ratings,
visit www.wago.com

2-conductor fuse terminal block for automotive blade-style fuse; with test point; without blown fuse indication; Electrical ratings are given by the fuse. Blade-style fuses: Observe touch-proof protection for 42 V and higher voltages!

Color	Item No.	Pack. Unit
○ gray	2006-1681	25

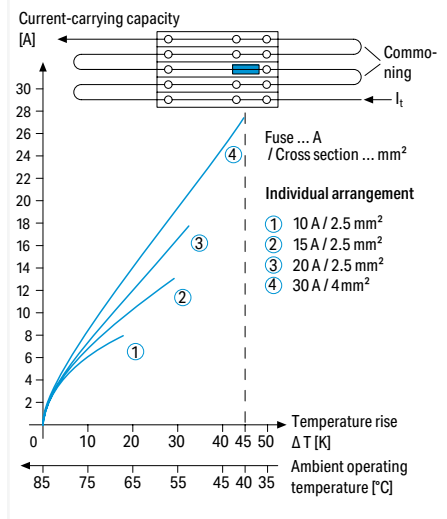

Application Notes on Fuse Terminal Blocks
Diagram: Individual arrangement

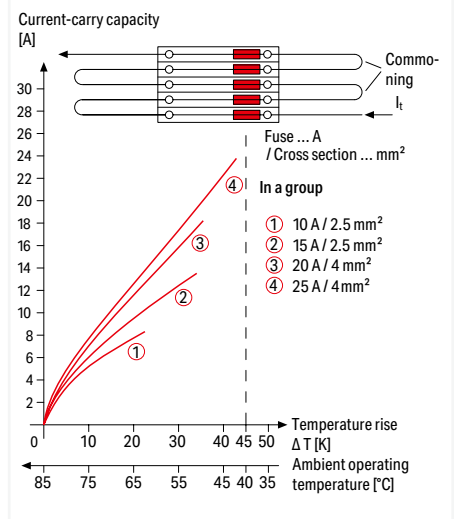

Application Notes on Fuse Terminal Blocks
Diagram: Block arrangement

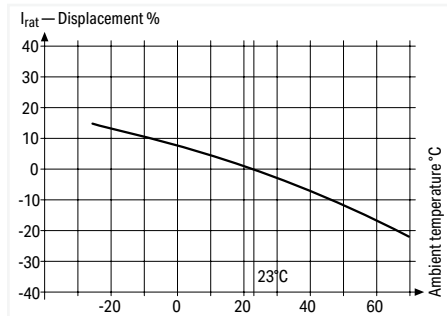

Application Notes on Fuse Terminal Blocks
Nominal current ratings for fuse cartridges are defined differently in international standards. This is why the recommended continuous current-carrying capacity of the fuses is a max. 80% of their nominal current according to DIN 72581/Part 3 (for an surrounding air temperature of 23°C).
Selecting the correct fuse cartridge is important for product safety within applications, as well as for fuse cartridge service life and reliability. Fuse cartridges will only operate perfectly as protection components (break-off point) if they are properly selected and used as intended (i.e., according to the state of the technology and valid specifications, as well as data sheet characteristics), according to basic safety requirements (i.e., persons, animals and property must be protected against hazards).

Information from the mini-automotive, blade-type fuse manufacturers

Derating T _{amb} / °C	%	F _T
-25	14	0.877
-20	13	0.885
-15	12	0.893
-10	11	0.901
- 5	10	0.909
0	9	0.917
5	8	0.926
10	6	0.943
15	4	0.962
20	2	0.980
23	0	1.000
30	- 2	1.020
35	- 4	1.042
40	- 6	1.064
45	- 8	1.087
50	-10	1.111
55	-13	1.149
60	-16	1.190
65	-19	1.235
70	-22	1.282

With regard to product safety, fuse cartridges must generally be tested both under normal and faulty operating conditions within your application.

PUSH-IN CAGE CLAMP®

Fused Disconnect Terminal Block with Pivoting Fuse Holder TOPJOB® S; for 5 x 20 mm, 5 x 30 mm and 1/4" x 1/4" Glass Cartridge Fuse 6 (10) mm²; 2006 Series

1

Technical Data	
0.5 ... 6 (10) mm ² ①	20 ... 8 AWG
800 V / 8 kV / 3 ②	600 V, 15 A ③
I _N 10 A	600 V, 15 A ④
Terminal block width: 7.5 mm / 0.295 inch	
13 ... 15 mm / 0.51 ... 0.59 inch	

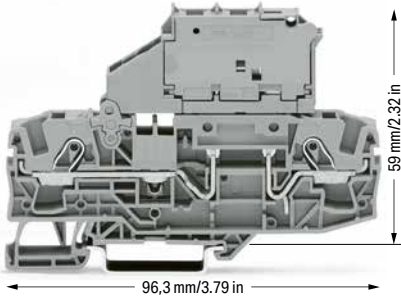

2-conductor fused disconnect terminal block with a pivoting fuse holder; without blown fuse indication
Electrical ratings are given by the fuse.

for 5 x 20 mm glass cartridge fuse

Color	Item No.	Pack. Unit
○ gray	2006-1611	25
○ orange	2006-1612	25

for 5 x 30 mm glass cartridge fuse

○ gray	2006-1621	25
--------	-----------	----

for 1/4" x 1/4" glass cartridge fuse

○ gray	2006-1631	25
--------	-----------	----

Other terminal blocks with the same profile:

Through	2006-1601	Page 125
---------	-----------	----------

Technical Data	
0.5 ... 6 (10) mm ² ①	20 ... 8 AWG
800 V / 8 kV / 3 ②	30 V, 15 A ③
I _N 10 A	30 V, 15 A ④
Terminal block width: 7.5 mm / 0.295 inch	
13 ... 15 mm / 0.51 ... 0.59 inch	

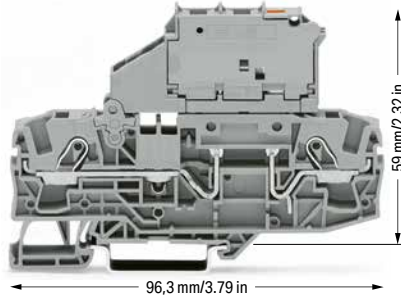

2-conductor fused disconnect terminal block with a pivoting fuse holder; gray; with blown fuse indication by LED
Electrical ratings are given by the fuse and blown fuse indication. Leakage current in case of a blown fuse: LED 2 mA

for 5 x 20 mm glass cartridge fuse

	Item No.	Pack. Unit
○ 12 ... 30 V	2006-1611/1000-541 ⑤	25
○ 30 ... 65 V	2006-1611/1000-542 ⑥	25
○ 120 V	2006-1611/1000-867	25
○ 230 V	2006-1611/1000-836	25

for 5 x 30 mm glass cartridge fuse

○ 12 ... 30 V	2006-1621/1000-541 ⑤	25
○ 30 ... 65 V	2006-1621/1000-542 ⑥	25
○ 230 V	2006-1621/1000-836	25
○ 380 ... 500 V	2006-1621/1000-859	25

for 1/4" x 1/4" glass cartridge fuse

○ 12 ... 30 V	2006-1631/1000-541 ⑤	25
○ 30 ... 65 V	2006-1631/1000-542 ⑥	25
○ 120 V	2006-1631/1000-867	25
○ 230 V	2006-1631/1000-836	25
○ 380 ... 500 V	2006-1631/1000-859	25

Other terminal blocks with the same profile:

Through	2006-1601	Page 125
---------	-----------	----------

Accessories; 2006 Series

Appropriate marking systems: WMB/Marking strips

End and intermediate plate; 1 mm thick

orange	2006-1692	100 (25)
gray	2006-1691	100 (25)

End plate for fuse terminal blocks; 2 mm thick

orange	2006-992	100 (25)
gray	2006-991	100 (25)

Push-in type jumper bar; insulated; I_N 41 A; light gray

2-way	2006-402	25
3-way	2006-403	25
4-way	2006-404	25
5-way	2006-405	25

Push-in type jumper bar; insulated; I_N 41 A; light gray

1 to 3	2006-433	25
1 to 4	2006-434	25
1 to 5	2006-435	25

Star point jumper; insulated; I_N = I_N terminal block; light gray

1-3-5	2006-405/011-000	25
-------	------------------	----

Protective warning marker; with black high-voltage symbol; for 5 terminal blocks

yellow	2006-115	100 (25)
--------	----------	----------

Test plug; with 500 mm cable; 2 mm Ø; max. 42 V

red	210-136	50 (1)
-----	---------	--------

WMB marking card; white; 10 strips with 10 markers/card; 5 ... 5.2 mm stretchable

plain	793-5501	5
-------	----------	---

① Conductor range: 0.5 ... 10 mm² "s+f-st"; Push-in termination: 2.5 ... 10 mm² "s" and 2.5 ... 6 mm² "insulated ferrules; 12 mm"
Depending on the conductor characteristic, a conductor with a smaller cross section can also be inserted via push-in termination.

② 800 V = rated voltage
8 kV = rated impulse voltage
3 = pollution degree (see Section 15)

③ 30 V / 0,8 kV / 3

④ 65 V / 1,5 kV / 3

Please observe the application notes:
Jumpers, from page 185
Marking, from page 684

Approvals and corresponding ratings, visit www.wago.com



Fused disconnect terminal block with a pivoting fuse holder - pivoting the fuse holder into the locked open position.

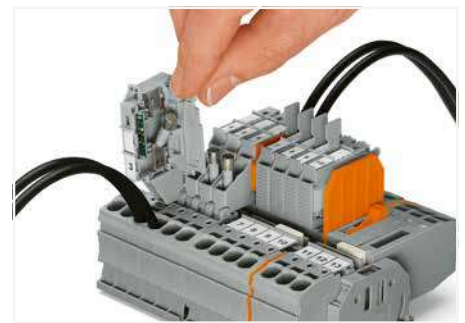

Fused disconnect terminal block with a pivoting fuse holder - fuse replacement: Open the cover to replace the fuse.

Fused Disconnect Terminal Block with Pivoting Fuse Holder TOPJOB® S; for ¼" x 1¼" Glass Cartridge Fuse

6 (10) mm²; 2006 Series

Technical Data

0.5 ... 6 (10) mm ² ①	20 ... 8 AWG
800 V / 8 kV / 3 ②	600 V, 15 A ^③
I _N 10 A	600 V, 15 A ^④
Terminal block width: 10.4 mm / 0.409 inch	
13 ... 15 mm / 0.51 ... 0.59 inch	



Fused disconnect terminal block with a pivoting fuse holder and end plate; without blown fuse indication
Electrical ratings are given by the fuse.

for ¼" x 1¼" glass cartridge fuse

Color	Item No.	Pack. Unit
○ gray	2006-1631/099-000	25

Technical Data

0.5 ... 6 (10) mm ² ①	20 ... 8 AWG
800 V / 8 kV / 3 ②	30 V, 15 A ^③
I _N 10 A	30 V, 15 A ^④
Terminal block width: 10.4 mm / 0.409 inch	
13 ... 15 mm / 0.51 ... 0.59 inch	

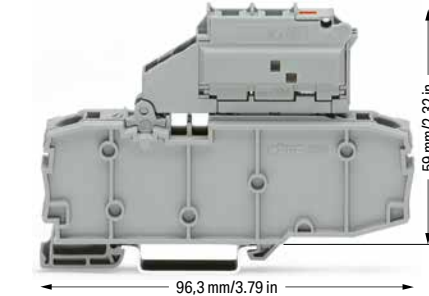

Fused disconnect terminal block with a pivoting fuse holder and end plate; gray; with blown fuse indication by LED
Electrical ratings are given by the fuse and blown fuse indication. Leakage current in case of a blown fuse: LED 2 mA

for ¼" x 1¼" glass cartridge fuse

	Item No.	Pack. Unit
○ 12 ... 30 V	2006-1631/1099-541 ⑤	25
○ 30 ... 65 V	2006-1631/1099-542 ⑥	25
○ 120 V	2006-1631/1099-867	25
○ 230 V	2006-1631/1099-836	25
○ 380 ... 500 V	2006-1631/1099-859	25

Other terminal blocks with the same profile:

Through 2006-1601 Page 125

Other terminal blocks with the same profile:

Through 2006-1601 Page 125

Accessories; 2006 Series

Appropriate marking systems: WMB/Marking strips

End plate for fuse terminal blocks; 2 mm thick

	orange	2006-992	100 (25)
	gray	2006-991	100 (25)

Push-in type jumper bar; insulated; I_N 25 A; light gray

	1 to 3	2002-433	25
	1 to 5	2002-435	25
	1 to 7	2002-437	25
	1 to 9	2002-439	25

Star point jumper; insulated; I_N = I_N terminal block; light gray

	1-3-5	2002-405/011-000	25
---	-------	------------------	----

Test plug; with 500 mm cable; 2 mm Ø; max. 42 V

	red	210-136	50 (1)
---	-----	---------	--------

WMB marking card; white; 10 strips with 10 markers/card; 5 ... 5.2 mm stretchable

	plain	793-5501	5
---	-------	----------	---

① Conductor range: 0.5 ... 10 mm² "s+f-st";
Push-in termination: 2.5 ... 10 mm² "s" and
2.5 ... 6 mm² "insulated ferrules; 12 mm"
Depending on the conductor characteristic, a conductor
with a smaller cross section can also be inserted
via push-in termination.

② 800 V = rated voltage
8 kV = rated impulse voltage
3 = pollution degree
(see Section 15)

③ 30 V / 0,8 kV / 3

④ 65 V / 1,5 kV / 3

Please observe the application notes:
Jumpers, from page 185
Marking, from page 684

Approvals and corresponding ratings,
visit www.wago.com

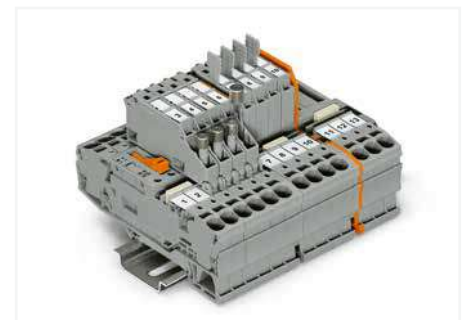

Pivoting fuse holder with spare fuse holder

Glass cartridge fuses

Series Item No.	Overload and short circuit protection		Short circuit protection only	
	Individual argmt.	Group argmt.	Individual argmt.	Group argmt.
Fused disconnect terminal blocks				
2006-1611	7.5	1.6 W	1.6 W	2.5 W
2006-1621	7.5	1.6 W	1.6 W	2.5 W
2006-1631	7.5	1.6 W	1.6 W	2.5 W
2006-1631 /099-...	10.4	2.5 W	2.5 W	2.5 W
2006-1631 /1099-...	10.4	2.5 W	2.5 W	2.5 W

When selecting glass cartridge fuses, make sure that the maximum power loss listed below is not exceeded. The power loss is determined according to IEC or EN 60947-7-3/VDE 0611-6 at 23°C. The temperature rise of the terminal blocks must be checked according to their application and mounting. Higher ambient temperatures represent an additional impact on fuse cartridges. Therefore, in such applications, the rated current must be reduced if necessary. More details are available from the manufacturers.

Disconnect/Test Terminal Block, Carrier Terminal Block, Through Terminal Block TOPJOB® S 6 (10) mm²; 2006 Series

1

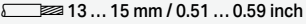
Technical Data	
0.5 ... 6 (10) mm ² ①	20 ... 8 AWG
1000 VAC/DC / 1500 VDC / 12 kV / 3 ②	
I _N 30 A 600 V, 30 A ^{VA} ; 1000 V, 30 A ^{VE}	
Terminal block width: 15 mm / 0.591 inch	
 13 ... 15 mm / 0.51 ... 0.59 inch	

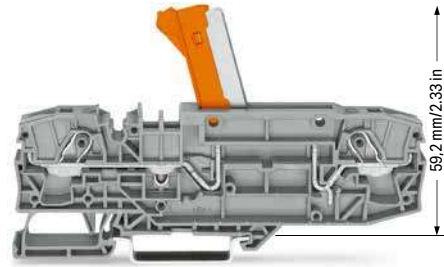

2-conductor disconnect/test terminal block; with test point; orange disconnect link

Color	Item No.	Pack. Unit
○ gray	2006-8671	12
● blue	2006-8674	12

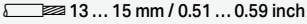
Technical Data	
0.5 ... 6 (10) mm ² ①	20 ... 8 AWG
1000 VAC/DC / 1500 VDC / 12 kV / 3 ②	
I _N 30 A 600 V, 30 A ^{VA} ; 1000 V, 30 A ^{VE}	
Terminal block width: 15 mm / 0.591 inch	
 13 ... 15 mm / 0.51 ... 0.59 inch	

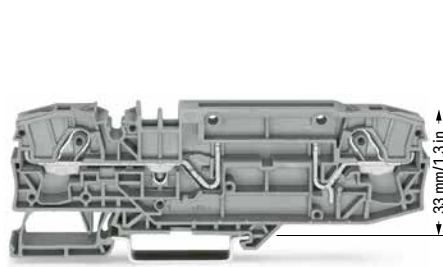

2-conductor carrier terminal block; with test point

Color	Item No.	Pack. Unit
○ gray	2006-8661	12
● blue	2006-8664	12

Accessories; item-specific
Disconnect plug for carrier terminal blocks; suitable when using a carrier terminal block as disconnect terminal block

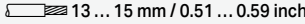

orange	2006-8401	48 (12)
--------	-----------	---------

Technical Data	
0.5 ... 6 (10) mm ² ①	20 ... 8 AWG
1000 VAC/DC / 1500 VDC / 12 kV / 3 ②	
I _N 30 A 600 V, 30 A ^{VA} ; 1000 V, 30 A ^{VE}	
Terminal block width: 15 mm / 0.591 inch	
 13 ... 15 mm / 0.51 ... 0.59 inch	

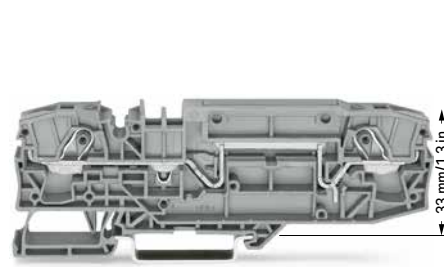

2-conductor through terminal block; with test point; same profile as 2-conductor disconnect terminal block

Color	Item No.	Pack. Unit
○ gray	2006-8601	12
● blue	2006-8604	12

Accessories; 2006 Series

Appropriate marking systems: WMB/Marking strips

End and intermediate plate; 1 mm thick

orange	2006-8692	48 (12)
gray	2006-8691	48 (12)

Protective warning marker; with black high-voltage symbol; for 5 terminal blocks

yellow	2006-115	100 (25)
--------	----------	----------

Push-in type jumper bar; insulated; I_N 41 A; light gray

1 to 3	2006-433	25
1 to 5	2006-435	25

Lockout cap; for conductor entry and operating slot

gray	2006-191	25
------	----------	----

Marking strip; plain; 11 mm wide; 50 m reel

white	2009-110	1
-------	----------	---

WMB marking card; white; 10 strips with 10 markers/card; 5 ... 5.2 mm stretchable

plain	793-5501	5
-------	----------	---

❶ Conductor range: 0.5 ... 10 mm² "s+f-st";
Push-in termination: 2.5 ... 10 mm² "s" and
2.5 ... 6 mm² "insulated ferrules; 12 mm"
Depending on the conductor characteristic, a conductor
with a smaller cross section can also be inserted
via push-in termination.

❷ 1000 VAC/DC = rated voltage
1500 VDC
12 kV = rated impulse voltage
3 = pollution degree
(see Section 15)

Please observe the application notes:
Marking, from page 684

Protective warning markers must be applied individually.

Approvals and corresponding ratings,
visit www.wago.com

Both 2006-8671 and 2006-8661 Disconnect Terminal
Blocks are specially designed for use in photovoltaic and
wind power systems, where voltages exceeding 1,000 V
(IEC) and 600 V (UL) occur (e.g., generator junction boxes).

- Ideal for high voltages in renewable energy applications
- **Disconnect terminal blocks with two alternative disconnect options:**
 - with orange knife disconnect (2006-8671)
 - with orange disconnect plug (2006-8661)
- These 2006 Series terminal blocks are approved for 1,500 VDC (IEC) or 1,000 VDC (UL) and 30 A.
- With a terminal block width of 15 mm, the maximum cross-section for solid and fine-stranded conductors is 10 mm² (AWG 8) and 6 mm² (AWG 10) for ferruled conductors.
- Equipped with two test slots
- Compatible with through terminal blocks of the same profile and all other terminal blocks TOPJOB® S



Disconnect/test terminal block with knife disconnect (2006-8671) in disconnect position

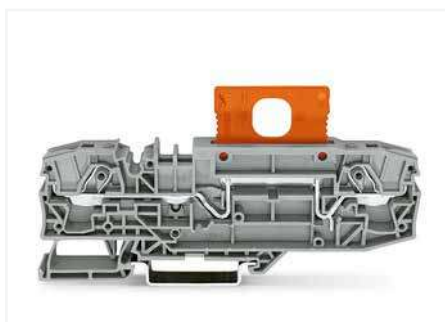

Carrier terminal block with disconnect plug (2006-8401) in operating position

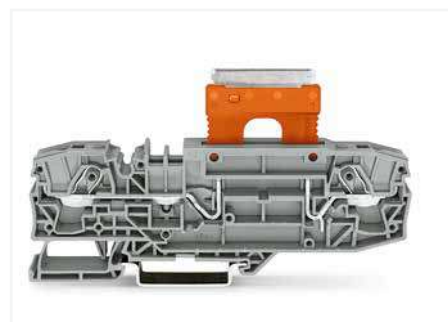

Carrier terminal block with disconnect plug (2006-8401) in parked position



Commoning a 15 mm-wide terminal block via push-in type jumper bars: 1 to 3 (2006-433) and 1 to 5 (2006-435).

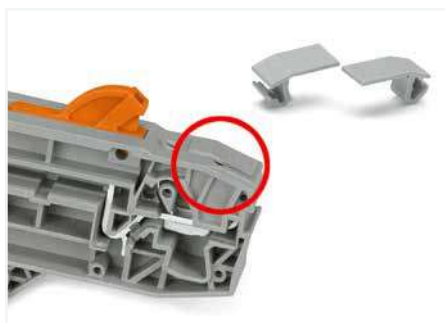

Cover (2006-191) seals unused conductor entry.

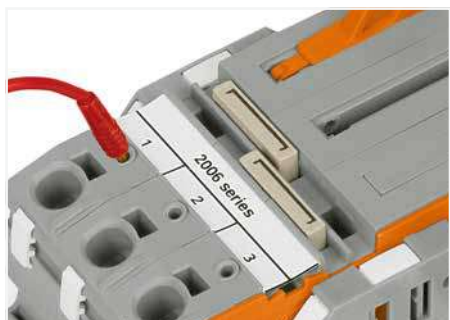

Test slots on both terminal block sides allow for direct measurement.



Test slots on both terminal block sides allow for direct measurement.



Alternatively, measurement can also be performed using Connectors (2006-511) from terminal block 1 to 2. Spacer modules (2006-549) must be used to compensate for the 15 mm terminal block width.

Current Transformer Terminal Blocks TOPJOB® S, 2007-8821 (Orange Disconnect Link)

1

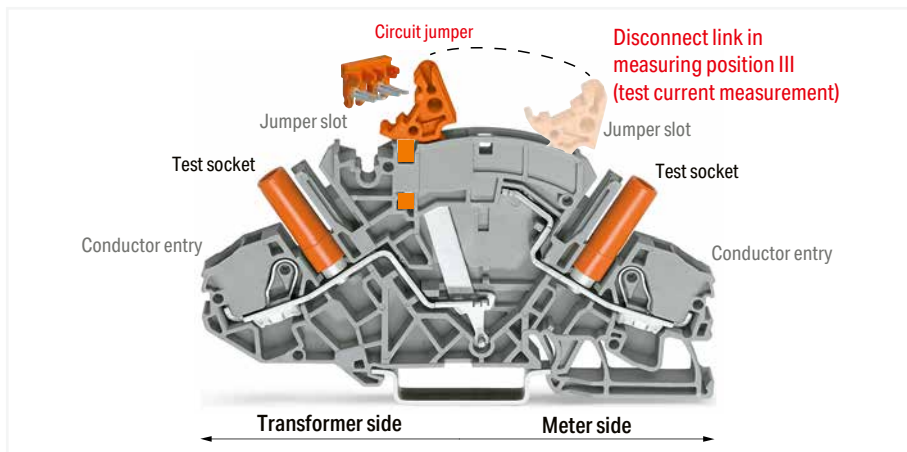
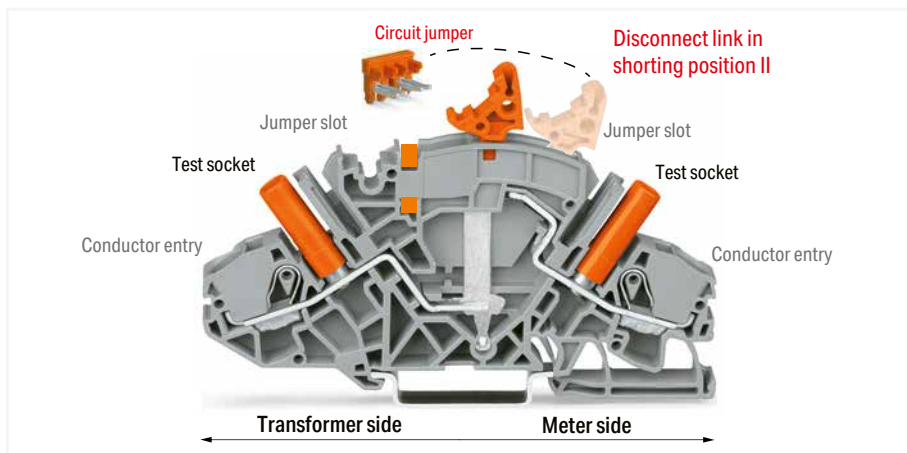
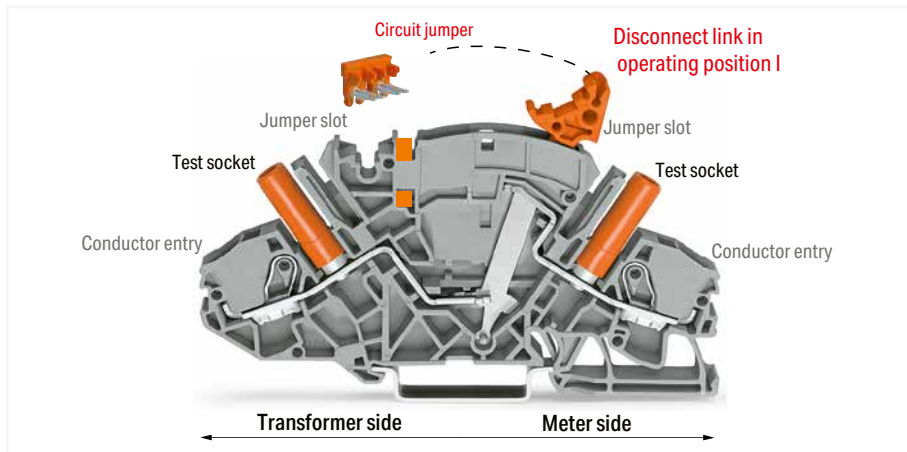

Current Transformer (Disconnect/Test) Terminal Block (2007-8821) is designed for current transformer circuits.

First, the current transformer is shorted via disconnect link and circuit jumper (insert jumper, move disconnect link from operating position I to shorting position II, activate shorting path). Connecting a measurement device via test socket on the meter side can only be performed once circuit disconnection is complete (disconnect link in measuring position III).

Advantages:

- Top-of-unit circuit jumper slot for shorting path activation
- Disconnect link provides intuitive and easy operation, as well as exact switching status indication.
- Combines high functionality with compact design (99.6 mm long and 8 mm wide).
- All 2007 Series terminal blocks are rated at 30 A/500 V (IEC) and 300 V (UL).
- With a terminal block width of 8 mm, the maximum cross-section for solid and fine-stranded conductors is 10 mm² (8 AWG) and 6 mm² (10 AWG) for ferruled conductors.
- Touch-proof test sockets for 4 mm Ø test plugs on transformer and meter side.
- Compatible with through and ground conductor terminal blocks having the same profile.



Preparing shorting path for the current transformer circuits.



Insert insulated, touch-proof circuit jumpers into jumper slot.



Using locking covers or profiles for adjacent terminal blocks allows disconnect links to be operated simultaneously.

Implementing a Current and Voltage Transformer Circuit TOPJOB® S



Disconnect link in operating position I
Terminal blocks required:
2 x disconnect/test terminal block (2007-8821)
1 x circuit jumper, orange (2007-8442)
Locking covers or interlocking links (option)

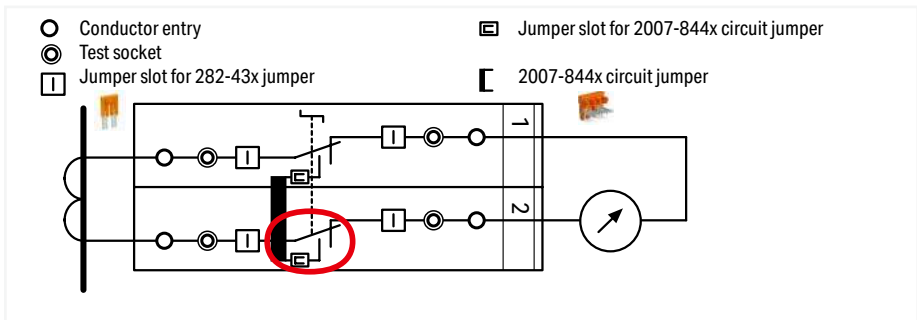

In the operating position, the measurement device is connected to the transformer, the circuit jumper is inserted and the disconnect link is in position I.



Disconnect link in shorting position II

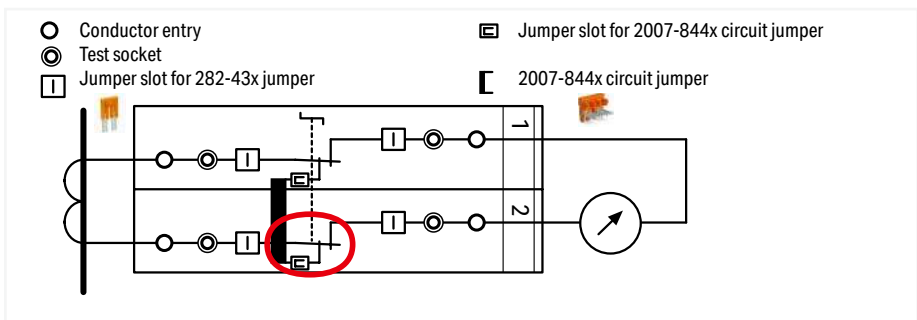

The transformer is not disconnected from the measuring device yet, the shorting path is activated by moving the disconnect link into shorting position II and the transformer is safely shorted.



Test current measurement: Disconnect link in measuring position III

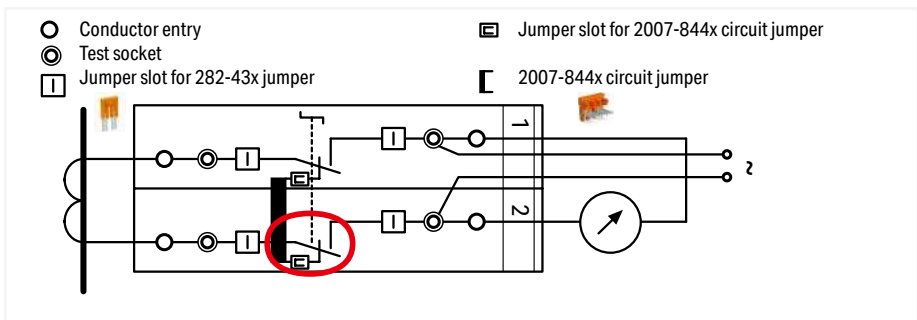

The measuring device is electrically disconnected from the transformer. If required, an external voltage can be applied to the measuring device via the test socket.



Measurement testing (using both test sockets)
Terminal block 1: Disconnect link in operating position I
Terminal block 2: Disconnect link in measuring position III

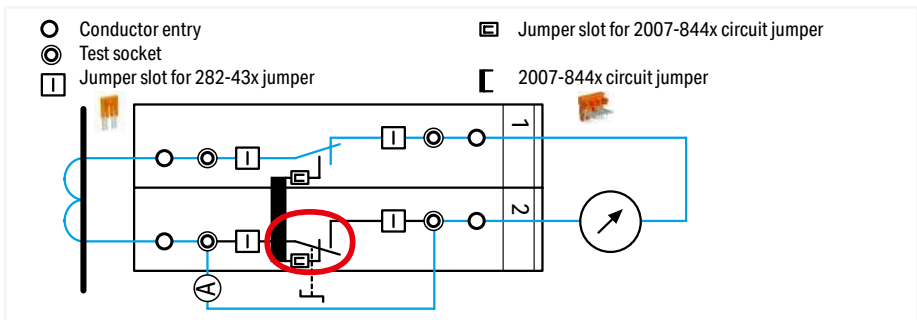

Measurement testing: First insert the reference current meter (A) into the test socket, then move the disconnect link into measurement point III (test current measurement).

Examples for Current Transformer Circuits TOPJOB® S

1



Measuring set for a three-phase current transformer
Terminal blocks required:

- 6 x disconnect/test terminal block (2007-8821)
- 3 x circuit jumper, orange (2007-8442)
- In addition: interlocking link, locking cover, lock-out

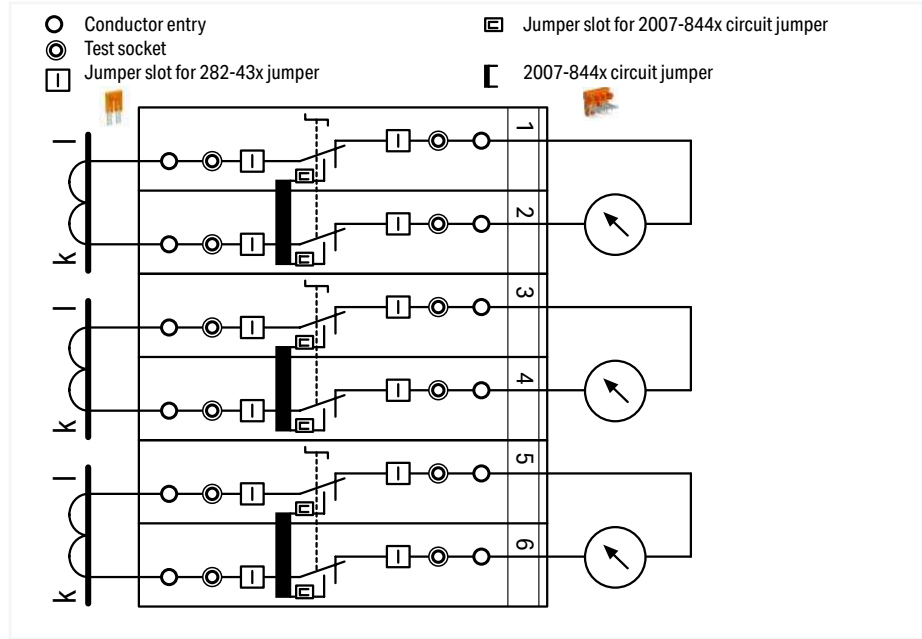

Pairs of disconnect links are interconnected via locking cover or interlocking link. Measurement testing is performed after the interlocking is released.



Measuring set for a three-phase current transformer
with 'Y' point

- Terminal blocks required:
- 6 x disconnect/test terminal block (2007-8821)
 - 1 x circuit jumper, orange (2007-8446)
 - 1 x jumper, orange (282-433)
 - In addition: interlocking link, locking cover, lock-out

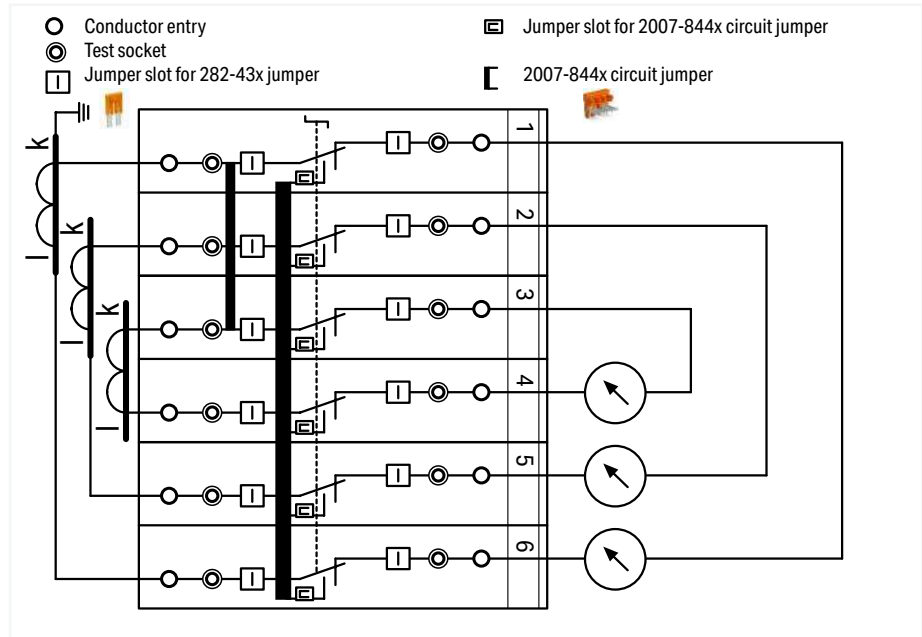

All six disconnect links are interconnected via locking cover or interlocking link.

Voltage Transformer Terminal Blocks TOPJOB® S, 2007-8811 (Light Gray Disconnect Link)

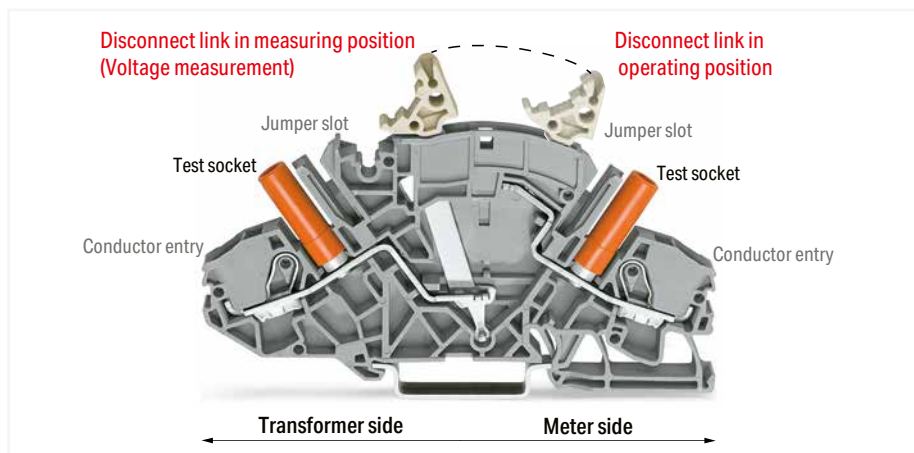

Voltage Transformer (Disconnect/Test) Terminal Block (2007-8811) is designed for current transformer circuits.

First, disconnect the voltage transformer from the circuit (move disconnect link from operating position to measurement position). Connecting a measurement device via test socket on the meter side can only be performed after disconnection is complete (measuring position).

Advantages:

- For voltage transformer circuits (no circuit jumper slot required as for 2007-8821 Current Transformer Terminal Block)
- Disconnect link provides intuitive and easy operation, as well as exact switching status indication.
- Combines high functionality with compact design (99.6 mm long and 8 mm wide).
- All 2007 Series terminal blocks are rated at 30 A/500 V (IEC) and 300 V (UL).
- With a terminal block width of 8 mm, the maximum cross-section for solid and fine-stranded conductors is 10 mm² (8 AWG) and 6 mm² (10 AWG) for ferruled conductors.
- Touch-proof test sockets for 4 mm Ø test plugs on transformer and meter side.
- Compatible with through and ground conductor terminal blocks having the same profile.



Example for voltage transformer testing:
Measuring set for single-phase voltage transformer testing

Terminal blocks required:

- 1 x disconnect/test terminal block (2007-8811)
- 1 x through terminal block (2007-8801)
- 1 x end plate, orange (2007-8892)
- In addition: locking cover, lock-out

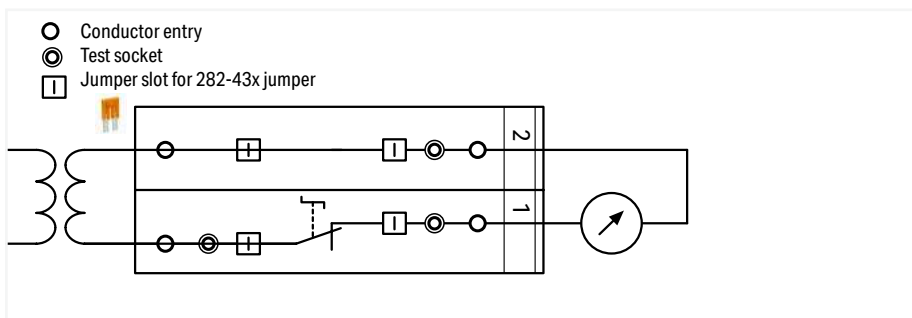

Disconnecting the voltage transformer from the circuit: Move disconnect link from operating position to measurement position.

Voltage measurement: Connecting a measurement device via test socket on the meter side can only be performed after disconnection is complete (measuring point).



Marking via WMB Multi markers or marking strips.



Additional commoning option on the transformer side



Multipole switching via snap-on type, transparent (locking) cover for disconnect links.

Disconnect/Test Terminal Block, Through Terminal Block, Ground Conductor Terminal Block TOPJOB® S; for Current and Voltage Transformer Circuits 6 mm²; 2007 Series

1

Technical Data	
0.5 ... 6 (10) mm ² ①	20 ... 8 AWG
500 V / 6 kV / 3 ②	300 V, 30 A ③
I _N 30 A	600 V, 30 A ④
Terminal block width: 8 mm / 0.315 inch	
13 ... 15 mm / 0.51 ... 0.59 inch	

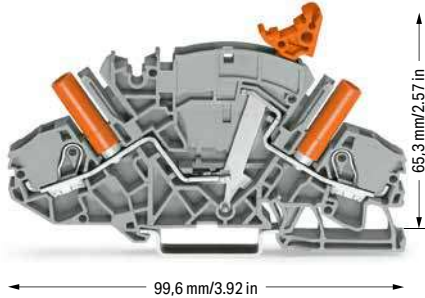

2-conductor disconnect/test terminal block; e.g., current transformer circuits; with circuit jumper slot; with touch-proof test sockets; for 4 mm Ø test plugs

Color	Item No.	Pack. Unit
○ gray	2007-8821	20

Technical Data	
0.5 ... 6 (10) mm ² ①	20 ... 8 AWG
500 V / 6 kV / 3 ②	300 V, 30 A ③
I _N 30 A	600 V, 30 A ④
Terminal block width: 8 mm / 0.315 inch	
13 ... 15 mm / 0.51 ... 0.59 inch	

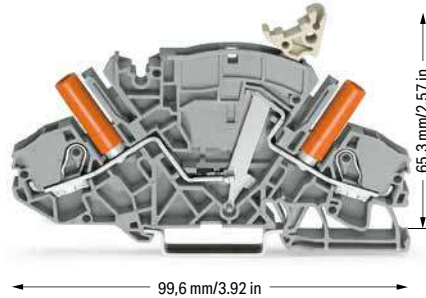

Disconnect/test terminal block; e.g., for voltage transformer circuits; with touch-proof test sockets; for 4 mm Ø test plugs

Color	Item No.	Pack. Unit
○ gray	2007-8811	20

Technical Data	
0.5 ... 6 (10) mm ² ①	20 ... 8 AWG
500 V / 6 kV / 3 ②	300 V, 30 A ③
I _N 30 A	600 V, 30 A ④
Terminal block width: 8 mm / 0.315 inch	
13 ... 15 mm / 0.51 ... 0.59 inch	

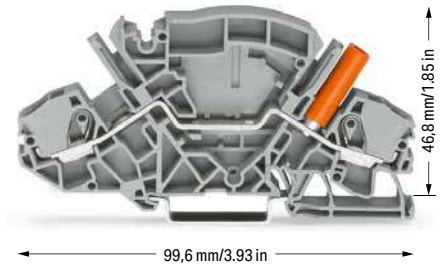

2-conductor through terminal block; with touch-proof test socket; for 4 mm Ø test plugs

Color	Item No.	Pack. Unit
○ gray	2007-8801	20
● blue	2007-8804	20

Accessories; item-specific

Ajacent jumper for switching lever; insulated; I_N 30 A; orange



2-way	2007-8442	50 (10)
3-way	2007-8443	50 (10)
4-way	2007-8444	50 (10)
5-way	2007-8445	50 (10)
6-way	2007-8446	50 (10)
7-way	2007-8447	50 (10)
8-way	2007-8448	50 (10)

Accessories; 2007 Series

End and separator plate; 1.5 mm thick; without lock-out seal option



orange	2007-8892	50 (10)
gray	2007-8891	50 (10)

End and separator plate; 1.5 mm thick; with lock-out seal option



orange	2007-8894	50 (10)
gray	2007-8893	50 (10)

Lock-out device; for disconnect link



yellow	2007-8899	100 (20)
--------	-----------	----------

Interlocking link; mechanically locks multiple links; 1 m long



transparent	210-254	1
-------------	---------	---

Locking cover; mechanically locks multiple links; transparent



1-pole	282-881	50 (10)
2-pole	282-882	50 (10)
3-pole	282-883	50 (10)
4-pole	282-884	50 (10)
5-pole	282-885	50 (10)
6-pole	282-886	50 (10)
7-pole	282-887	50 (10)
8-pole	282-888	50 (10)

Appropriate marking systems: WMB/Marking strips

Jumper; insulated; I_N 30 A; orange



2-way	282-432	50 (10)
3-way	282-433	50 (10)
4-way	282-434	50 (10)
5-way	282-435	50 (10)
6-way	282-436	50 (10)
7-way	282-437	50 (10)
8-way	282-438	50 (10)
9-way	282-439	50 (10)
10-way	282-440	50 (10)

Jumper with safety lid; insulated; I_N 30 A; orange



2-way	282-432/100-000	50 (10)
3-way	282-433/100-000	50 (10)
4-way	282-434/100-000	50 (10)

Jumper; insulated; I_N 30 A; orange



1-3	282-433/011-000	50 (10)
1-3-5	282-435/011-000	50 (10)
1-3-4-5	282-435/300-000	50 (10)
1-2-4-6	282-436/301-000	50 (10)
1-3-5-7	282-437/011-000	50 (10)
1-4-7	282-437/012-000	50 (10)
1-2-5-8	282-438/300-000	50 (10)
1-4-7-8	282-438/301-000	50 (10)
1-3-5-7-9	282-439/011-000	50 (10)

Protective warning marker; with black high-voltage symbol; for 5 terminal blocks



yellow	2006-115	100 (25)
--------	----------	----------

Marking strip; plain; 11 mm wide; 50 m reel



white	2009-110	1
-------	----------	---

WMB marking card; white; 10 strips with 10 markers/card; stretchable 5 ... 5.2 mm



plain	793-5501	5
-------	----------	---

WMB marking card; 10 strips with 10 markers/card; stretchable 5 ... 5.2 mm; yellow



k/I (50x)	794-5553/000-002	5
-----------	------------------	---

WMB marking card; 10 strips with 10 markers/card; stretchable 5 ... 5.2 mm; blue



U/V (50x)	794-5554/000-006	5
-----------	------------------	---

Technical Data

0.5 ... 6 (10) mm² ① | 20 ... 8 AWG

Terminal block width: 8 mm / 0.315 inch

13 ... 15 mm / 0.51 ... 0.59 inch



46,8 mm/1.85 in

99,6 mm/3.93 in

2-conductor ground terminal block; with touch-proof test socket; for 4 mm Ø test plugs

Color	Item No.	Pack. Unit
● green-yellow	2007-8807	20

① Conductor range: 0.5 ... 10 mm² "s+f-st"; Push-in termination: 2.5 ... 10 mm² "s" and 2.5 ... 6 mm² "insulated ferrules; 12 mm" Depending on the conductor characteristic, a conductor with a smaller cross section can also be inserted via push-in termination.

② 500 V = rated voltage
6 kV = rated impulse voltage
3 = pollution degree (see Section 15)

Please observe the application notes: Marking, from page 684

Approvals and corresponding ratings, visit www.wago.com



Marking via WMB Multi markers or marking strips.

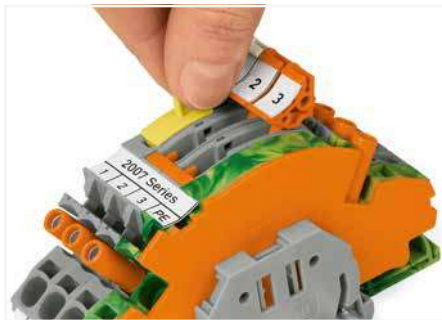

Lock-out prevents accidental operation of disconnect link.



Lock-out snaps into one of two notched positions.



Interlocking link mechanically locks multiple links for multi-pole switching applications.



A lock-out seal can be used on the disconnect link in operating position I in combination with an end and separator plate (2007-8893 or 2007-8894).

Terminal Block Assembly TOPJOB® S; for Current and Voltage Transformers

6 (10) mm²; 2007 Series

1

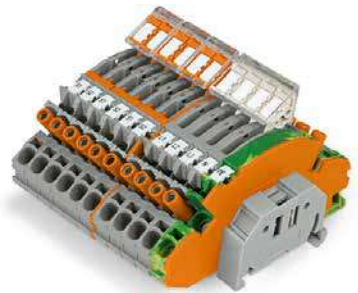

Item No. for 2007-8873	Quantity
Designation	
249-117	2
Screwless end stop; 10 mm wide	
282-882	3
Locking cover; mechanically locks multiple links, 2-pole	
282-884	1
Locking cover; mechanically locks multiple links, 4-pole	
2007-8442	3
Circuit jumper; insulated; 2-way	
2007-8807	1
2-conductor ground terminal block; with touch-proof test socket; for 4 mm Ø test plugs	
2007-8811	4
2-conductor disconnect/test terminal block; with touch-proof test sockets; for 4 mm Ø test plugs	
2007-8821	6
2-conductor disconnect/test terminal block; with touch-proof test sockets; for 4 mm Ø test plugs	
2007-8892	2
End and separator plate; 1.5 mm thick; without lock-out seal option	
2009-115	21
WMB Inline, plain; 1,500 WMB markers (5 mm)/reel; 5 ... 5.2 mm stretch-able	markers
282-435/011-000	1
Jumper; insulated; 1-3-5	
Assembly width incl. end stop: 11.2 cm	

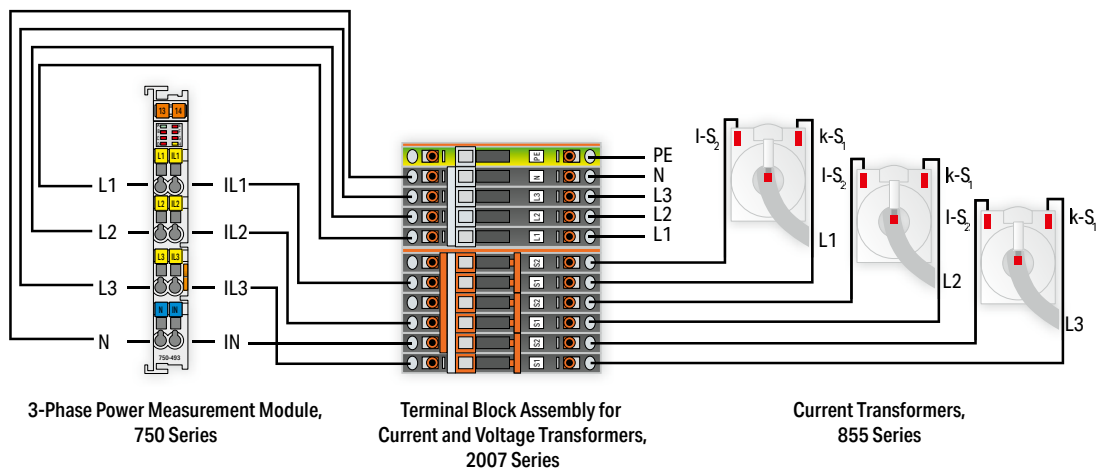



Item No. for 2007-8876	Quantity
Designation	
249-117	2
Screwless end stop; 10 mm wide	
282-369	1
Collective jumper carrier; for DIN-35 rail; compatible with jumpers for transverse switching terminal block (282-811) and longitudinal switching disconnect terminal block (282-821)	
282-882	3
Locking cover; mechanically locks multiple links, 2-pole	
2007-8442	3
Circuit jumper; insulated; 2-way	
2007-8821	6
2-conductor disconnect/test terminal block; with touch-proof test sockets; for 4 mm Ø test plugs	
2007-8892	1
End and separator plate; 1.5 mm thick; without lock-out seal option	
2009-115	12
WMB Inline, plain; 1,500 WMB markers (5 mm)/reel; 5 ... 5.2 mm stretchable	markers
282-435/011-000	1
Jumper; insulated; 1-3-5	
Assembly width incl. end stop: 8.5 cm	

Fuse Plug TOPJOB® S on Carrier Terminal Block 2.5 (4) mm² 2004 Series

1

Technical Data

250 V / I_N 6.3 A
Plug width: 6.1 mm / 0.24 inch

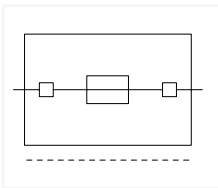

Fuse plug with pull-tab; for 5 x 20 mm glass cartridge fuses
Electrical ratings are given by the fuse.

Color	Item No.	Pack. Unit
○ gray	2004-911	50

Technical Data

250 V / I_N 6.3 A
Plug width: 6.1 mm / 0.24 inch

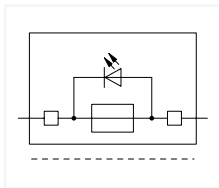

Fuse plug with pull-tab; for 5 x 20 mm glass cartridge fuses; with indicator lamp, gray
Electrical ratings are given by the fuse and blown fuse indication. Leakage current in case of a blown fuse: LED 2 mA

	Item No.	Pack. Unit
○ 12 ... 30 V	2004-911/1000-541 ①	50
○ 30 ... 65 V	2004-911/1000-542 ②	50
○ 120 V	2004-911/1000-867	50
○ 230 V	2004-911/1000-836	50

① 30 V / 0,8 kV / 3

② 65 V / 1,5 kV / 3

Approvals and corresponding ratings, visit www.wago.com

Accessories; for fuse plugs

Appropriate marking systems:
WMB/Marking strips

Double-deck carrier terminal block; 0.25 ... 2.5 (4) mm² / 22 ... 12 AWG
Terminal block width: 5.2 mm / 0.205 inch

	L/L	2002-2961	50

Double-deck carrier terminal block; 0.25 ... 2.5 (4) mm² / 22 ... 12 AWG
Terminal block width: 5.2 mm / 0.205 inch

	L/N	2002-2963	50

End and intermediate plate; 1 mm thick

	orange	2002-2992	100 (25)
	gray	2002-2991	100 (25)

End plate for fuse terminal blocks; 2 mm thick

	orange	2002-992	100 (25)
	gray	2002-991	100 (25)

Shorting link; 5 x 20 mm; allows the fuse plug to be used as a disconnect plug

	I _N 6.3 A	281-503	250 (25)
--	----------------------	---------	----------

Accessories; for fuse plugs

Appropriate marking systems: WMB/Marking strips

2-conductor carrier terminal block; 0.25 ... 2.5 (4) mm² / 22 ... 12 AWG
Terminal block width: 5.2 mm / 0.205 inch

	gray	2002-1661	50
--	------	-----------	----

4-conductor carrier terminal block; 0.25 ... 2.5 (4) mm² / 22 ... 12 AWG
Terminal block width: 5.2 mm / 0.205 inch

	gray	2002-1861	50
--	------	-----------	----

2-conductor carrier terminal block; with push-button 0.25 ... 2.5 (4) mm² / 22 ... 12 AWG
Terminal block width: 5.2 mm / 0.205 inch

	gray	2202-1661	50
--	------	-----------	----

4-conductor carrier terminal block; with push-button 0.25 ... 2.5 (4) mm² / 22 ... 12 AWG
Terminal block width: 5.2 mm / 0.205 inch

	gray	2202-1861	50
--	------	-----------	----

End and intermediate plate; 1 mm thick

	orange	2002-1692	100 (25)
	gray	2002-1691	100 (25)

End and intermediate plate; 1 mm thick

	orange	2002-1892	100 (25)
	gray	2002-1891	100 (25)

3-conductor carrier terminal block; 0.25 ... 2.5 (4) mm² / 22 ... 12 AWG
Terminal block width: 5.2 mm / 0.205 inch

	gray	2002-1761	50
--	------	-----------	----

2-conductor carrier terminal block; 0.25 ... 2.5 (4) mm² / 22 ... 12 AWG
Terminal block width: 5.2 mm / 0.205 inch

	gray	2002-1961	50
--	------	-----------	----

3-conductor carrier terminal block; with push-button 0.25 ... 2.5 (4) mm² / 22 ... 12 AWG
Terminal block width: 5.2 mm / 0.205 inch

	gray	2202-1761	50
--	------	-----------	----

2-conductor carrier terminal block; with push-button 0.25 ... 2.5 (4) mm² / 22 ... 12 AWG
Terminal block width: 5.2 mm / 0.205 inch

	gray	2202-1961	50
--	------	-----------	----

End and intermediate plate; 1 mm thick

	orange	2002-1792	100 (25)
	gray	2002-1791	100 (25)

End and intermediate plate; 1 mm thick

	orange	2002-1992	100 (25)
	gray	2002-1991	100 (25)

WMB marking card; white; 10 strips with 10 markers/card; 5 ... 5.2 mm stretchable

	plain	793-5501	5
--	-------	----------	---

WMB marking card; white; 10 strips with 10 markers/card; 5 ... 5.2 mm stretchable

	F1, ..., F10 (10x)	794-5615	5
	F11, ..., F20 (10x)	794-5616	5
	F21, ..., F30 (10x)	794-5617	5
	F31, ..., F40 (10x)	794-5618	5
	F41, ..., F50 (10x)	794-5619	5

Fuse Plugs TOPJOB® S on Carrier Terminal Blocks 2.5 (4) mm²

Technical Information

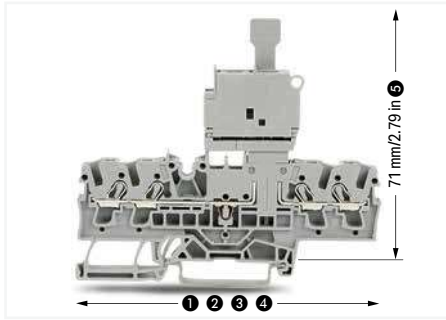

Fuse plug dimensions:

- ① 66.1 mm / 2.62 inch for 2002-1661
- ② 76.8 mm / 3.02 inch for 2002-1761
- ③ 87.5 mm / 3.45 inch for 2002-1861
- ④ 72.9 mm / 2.87 inch for 2002-1961
- ⑤ with inserted fuse plug



Using fuse plugs with rail-mount terminal blocks for control circuit protection is highly advantageous because the function and wiring levels are separated:

- No additional cost for assembly and wiring
- No risk of accidental contact with live parts when disconnecting the fuse plug
- The fuse plug is completely separated from the carrier terminal block when replacing a fuse – away from current carrying parts
- The fuse plug can be removed by service personnel
- No unintentional reclosing of the circuit by another person
- Quickly exchange a fuse by using a prepared "stand-by plug"

Fuse plug features for quick and safe applications:

- Optional LED indicates blown fuse
- Top-of-unit marking slot provides clear carrier terminal block identification
- Two test slots with touch contacts
- Terminal blocks/plugs provide high-density wiring in a width of just 5.2/6.1 mm
- May be used as a disconnect plug in combination with a shorting link

Glass cartridge fuses 5 x 20

Series Item No.	Overload and short circuit protection		Short circuit protection only	
	Individual argmt.	Group argmt.	Individual argmt.	Group argmt.
Fuse terminal blocks				
2004-911				
2004-911/.....	1.6 W	1.6 W	2.5 W	2.5 W

When selecting glass cartridge fuses, make sure that the maximum power loss listed below is not exceeded. The power loss is determined according to IEC or EN 60947-7-3/VDE 0611-6 at 23°C. The temperature rise of the terminal blocks must be checked according to their application and mounting. Higher ambient temperatures represent an additional impact on fuse cartridges. Therefore, in such applications, the rated current must be reduced if necessary. More details are available from the manufacturers.

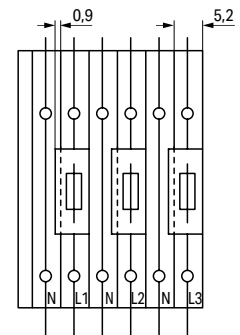

Open side of terminal block left

Please note:

The extra width of the plug (6.1 mm compared to 5.2 mm for carrier terminal blocks) must be compensated for with intermediate plates (1 mm) when building an assembly of carrier terminal blocks equipped with fuse plugs.

Fuse Plug TOPJOB® S on Carrier Terminal Block 6 (10) mm² 2006 Series

1

Technical Data		
800 V / I _N 10 A		
Plug width: 7.4 mm / 0.291 inch		

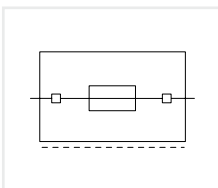

Fuse plug with pull-tab
Electrical ratings are given by the fuse.

for 5 x 20 mm glass cartridge fuse

Color	Item No.	Pack. Unit
○ gray	2006-911	25

Technical Data		
800 V / I _N 10 A		
Plug width: 7.4 mm / 0.291 inch		

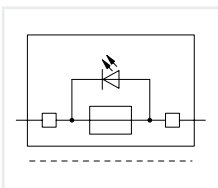

Fuse plug with pull-tab; with indicator lamp; gray
Electrical ratings are given by the fuse and blown fuse indication. Leakage current in case of a blown fuse: LED 2 mA

for 5 x 20 mm glass cartridge fuse

	Item No.	Pack. Unit
○ 12 ... 30 V	2006-911/1000-541 ①	25
○ 30 ... 65 V	2006-911/1000-542 ②	25
○ 230 V	2006-911/1000-836	25

Technical Data		
800 V / I _N 10 A		
Plug width: 10.4 mm / 0.409 inch		

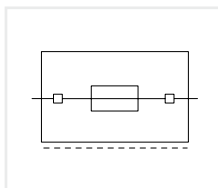

Fuse plug with pull-tab
Electrical ratings are given by the fuse.

for ¼" x 1¼" glass cartridge fuse

Color	Item No.	Pack. Unit
○ gray	2006-931/099-000	25

for 5 x 30 mm glass cartridge fuse		
○ gray	2006-921	25

for 5 x 30 mm glass cartridge fuse		
○ 12 ... 30 V	2006-921/1000-541 ①	25
○ 30 ... 65 V	2006-921/1000-542 ②	25
○ 230 V	2006-921/1000-836	25
○ 380 ... 500 V	2006-921/1000-859	25

for ¼" x 1¼" glass cartridge fuse		
○ gray	2006-931	25

for ¼" x 1¼" glass cartridge fuse		
○ 12 ... 30 V	2006-931/1000-541 ①	25
○ 120 V	2006-931/1000-867 ②	25
○ 230 V	2006-931/1000-836	25
○ 380 ... 500 V	2006-931/1000-859	25

Accessories; item-specific			
End and intermediate plate; 1 mm thick			
	orange	2006-1692	100 (25)
	gray	2006-1691	100 (25)

Accessories; item-specific			
End and intermediate plate; 1 mm thick			
	orange	2006-1692	100 (25)
	gray	2006-1691	100 (25)

Accessories; item-specific			
Intermediate plate; 2.9 mm thick			
	orange	2006-1696	100 (25)
	gray	2006-1695	100 (25)

Accessories; for fuse plugs

End plate for fuse terminal blocks; 2 mm thick			
	orange	2006-992	100 (25)
	gray	2006-991	100 (25)

Appropriate marking systems: WMB/Marking strips			
Shorting link; 5 x 20 mm; allows the fuse plug to be used as a disconnect plug			
	I _N 6.3 A	281-503	250 (25)

WMB marking card; white; 10 strips with 10 markers/card; 5 ... 5.2 mm stretchable

2-conductor carrier terminal block; 0.5 ... 6 (10) mm ² / 20 ... 8 AWG			
Terminal block width: 7.5 mm / 0.295 inch			
	gray	2006-1661	25
	blue	2006-1664	25

WMB marking card; white; 10 strips with 10 markers/card; 5 ... 5.2 mm stretchable			
	plain	793-5501	5

	F1, ..., F10 (10x)	794-5615	5
	F11, ..., F20 (10x)	794-5616	5
	F21, ..., F30 (10x)	794-5617	5
	F31, ..., F40 (10x)	794-5618	5
	F41, ..., F50 (10x)	794-5619	5

Technical Data

800 V / I_N 10 A

Plug width: 10.4 mm / 0.409 inch

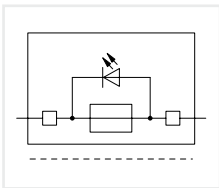

Fuse plug with pull-tab; with indicator lamp; gray
Electrical ratings are given by the fuse and blown fuse
indication. Leakage current in case of a blown fuse: LED
2 mA
for ¼" x 1¼" glass cartridge fuse

	Item No.	Pack. Unit
○ 12 ... 30 V	2006-931/1099-541 ①	25
○ 30 ... 65 V	2006-931/1099-542 ②	25
○ 230 V	2006-931/1099-836	25
○ 380 ... 500 V	2006-931/1099-859	25

① 30 V / 0,8 kV / 3

② 65 V / 1,5 kV / 3

Approvals and corresponding ratings,
visit www.wago.com

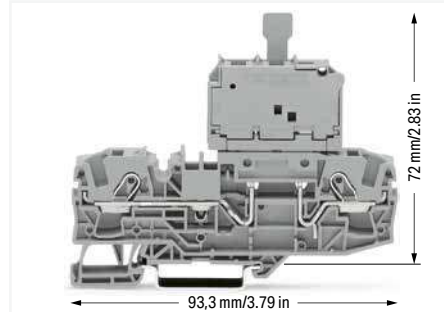

Using fuse plugs with rail-mount terminal blocks for control circuit protection is highly advantageous because the function and wiring levels are separated:

- No additional cost for assembly and wiring
 - No risk of accidental contact with live parts when disconnecting the fuse plug
 - The fuse plug is completely separated from the carrier terminal block when replacing a fuse – away from current carrying parts
 - The fuse plug can be removed by service personnel
 - No unintentional reclosing of the circuit by another person
 - Quickly exchange a fuse by using a prepared "stand-by plug"
- Fuse plug features for quick and safe applications:
- Optional LED indicates blown fuse
 - Top-of-unit marking slot provides clear carrier terminal block identification
 - Two test slots with touch contacts
 - Terminal blocks/plugs provide high-density wiring in a width of just 7.5/7.4 (10.4) mm
 - May be used as a disconnect plug in combination with a shorting link

Glass cartridge fuses

Series Item No.	Overload and short circuit protection		Short circuit protection only	
	Individual argmt.	Group argmt.	Individual argmt.	Group argmt.
Fused disconnect terminal blocks				
2006-911	7.5	1.6 W	1.6 W	2.5 W
2006-921	7.5	1.6 W	1.6 W	2.5 W
2006-931	7.5	1.6 W	1.6 W	2.5 W
2006-931 /099...	10.4	2.5 W	2.5 W	2.5 W
2006-931 /1099...	10.4	2.5 W	2.5 W	2.5 W

When selecting glass cartridge fuses, make sure that the maximum power loss listed below is not exceeded. The power loss is determined according to IEC or EN 60947-7-3/VDE 0611-6 at 23°C. The temperature rise of the terminal blocks must be checked according to their application and mounting. Higher ambient temperatures represent an additional impact on fuse cartridges. Therefore, in such applications, the rated current must be reduced if necessary. More details are available from the manufacturers.

Accessories; item-specific

Intermediate plate; 2.9 mm thick

	orange	2006-1696	100 (25)
	gray	2006-1695	100 (25)

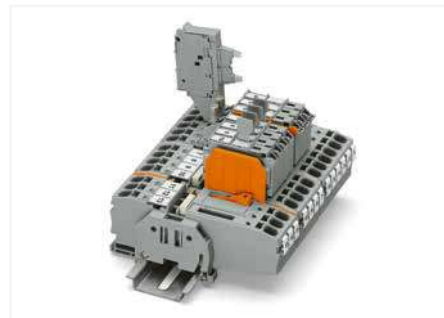

Pivoting fuse holder with spare fuse holder



The end plate ensures that the fuse can only be removed when the fuse plug is pulled out.

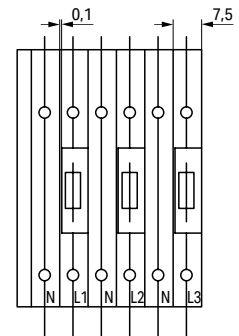

Open side of terminal block left

When using 10.4 mm wide plugs, please note: The extra width of the plug (10.4 mm compared to 7.5 mm for carrier terminal blocks) must be compensated for with intermediate plates (2.9 mm) when building an assembly of carrier terminal blocks equipped with fuse plugs.

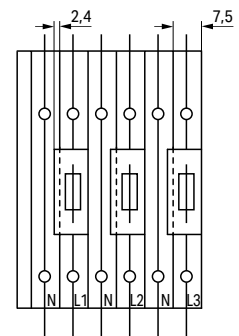

Open side of terminal block left

When using 10.4 mm wide plugs, please note: The extra width of the plug (10.4 mm compared to 7.5 mm for carrier terminal blocks) must be compensated for with intermediate plates (2.9 mm) when building an assembly of carrier terminal blocks equipped with fuse plugs.

Sensor Terminal Blocks and Actuator Terminal Blocks TOPJOB® S

2000 Series

Description and Installation

1

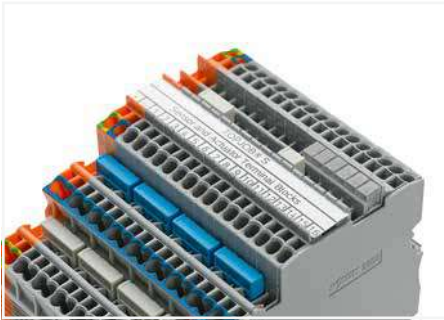

Commoning (signal level):

Commoning the signal level with push-in type jumper bars (2000 Series). Models with an LED can only be commoned in one jumper slot.

Test Plug Adapters can be used in all jumper slots.



Upper level: two independent signal pathways



Commoning (potential level):

Commoning potential levels via push-in type jumper bars (2000 Series).



Power supply:

Orange supply terminal block of same profile from both the cabinet and sensor sides

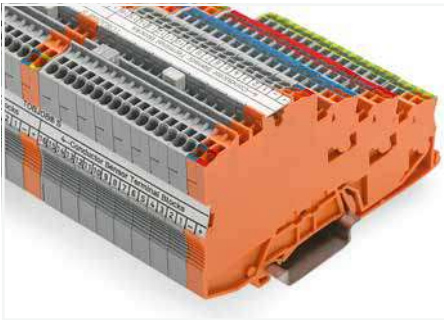

Marking:

Marking strips (2009-110) – from the top or the side

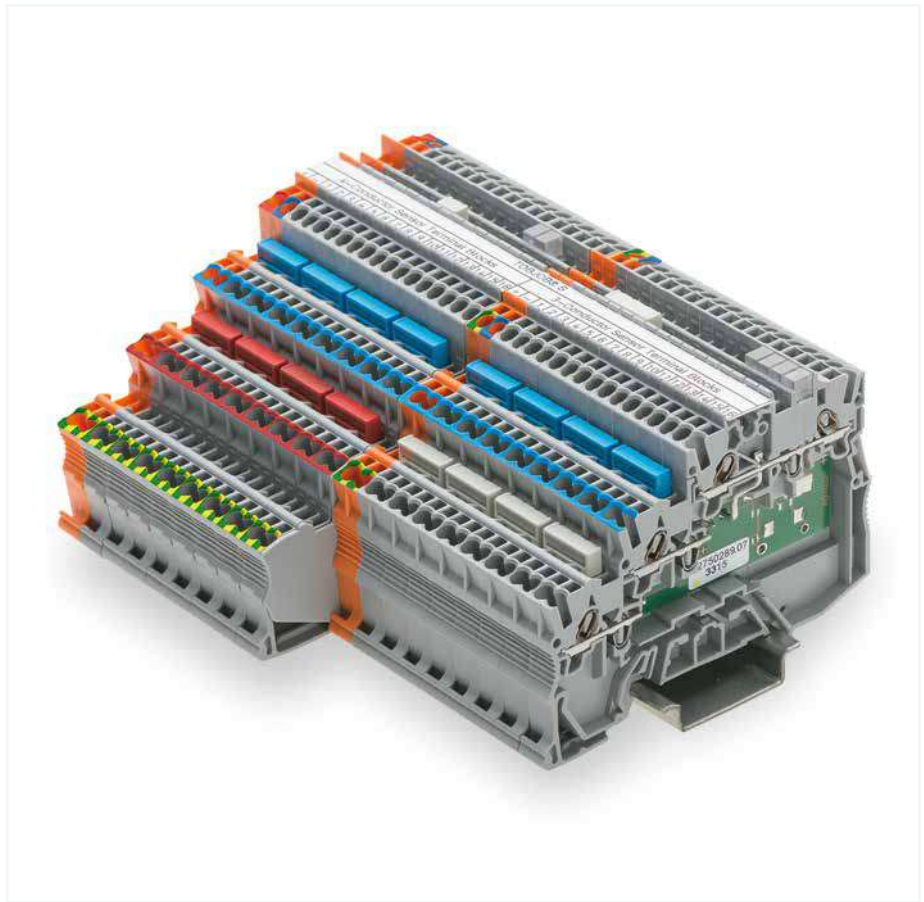

Terminal block assembly with 4-conductor sensor terminal blocks and 3-conductor actuator terminal blocks

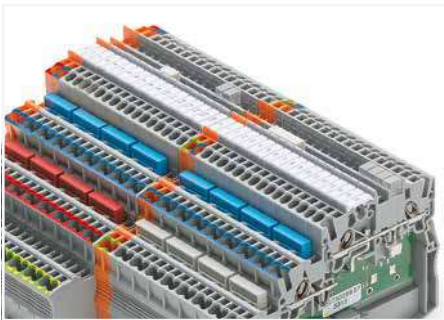

Marking:

3.5 mm WMB markers (793-35xx) from the top or the side – additional marking option via marker carrier

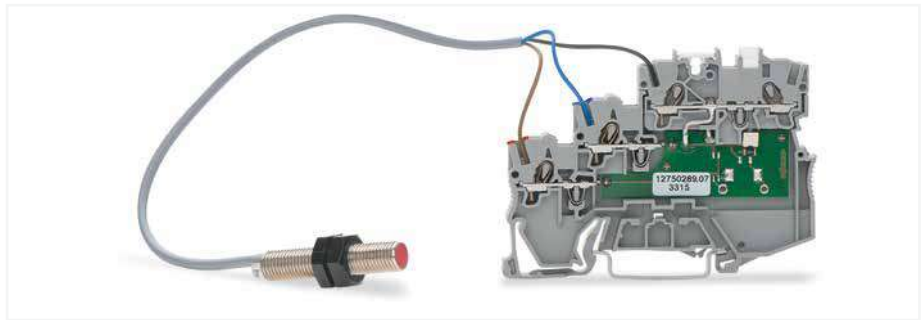

3-conductor sensor LED terminal block with a connected sensor



Commoning (potential level):
Continuous commoning in the potential levels via push-in type jumper bars for even pole numbers (2000 Series)



Potential levels: two adjacent commoning options on a current bar

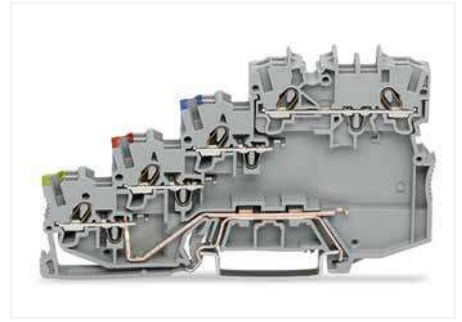

4-conductor sensor terminal block with ground contact

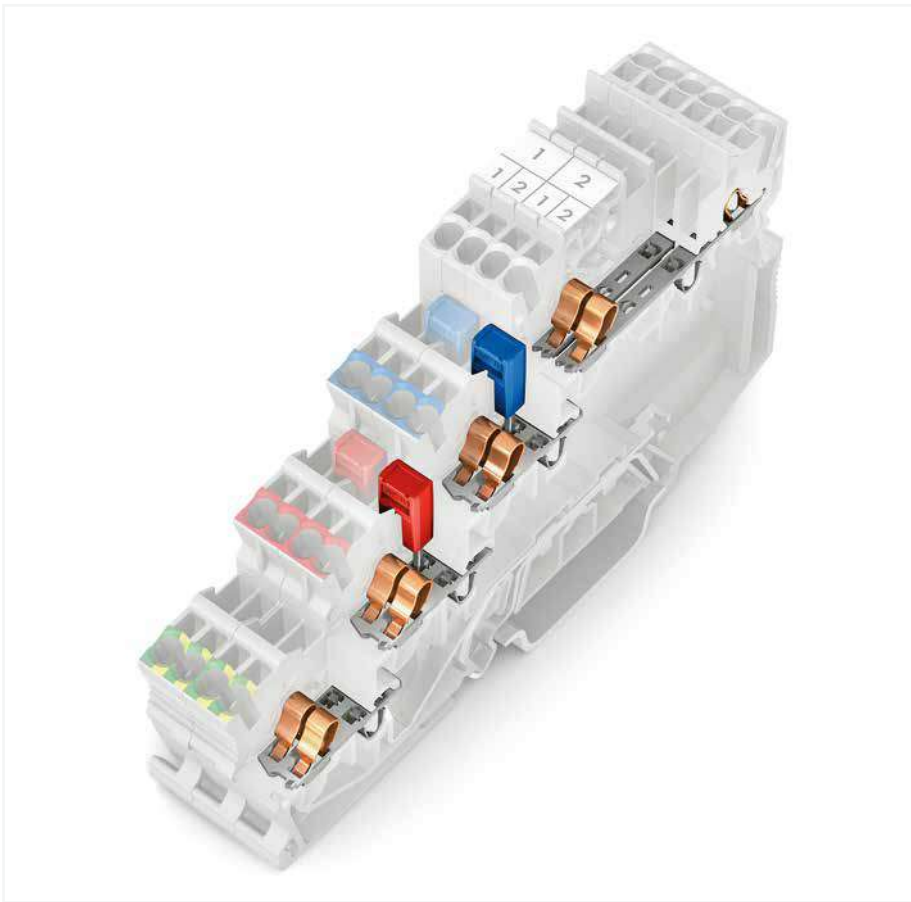

Upper level: two independent signal pathways, in 3.5 mm spacing per pole, with a dual jumper slot
Lower levels: two interconnected potential clamping units, with a single jumper slot, can be commoned in both directions



Ground commoning:
For sensor and actuator terminal blocks without ground connection to the DIN-rail, the ground connection can be performed by commoning to the terminal block with a ground foot.

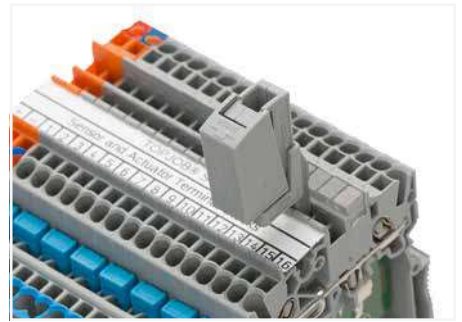

Testing via testing tap (2009-182) (up to max. 42 V).

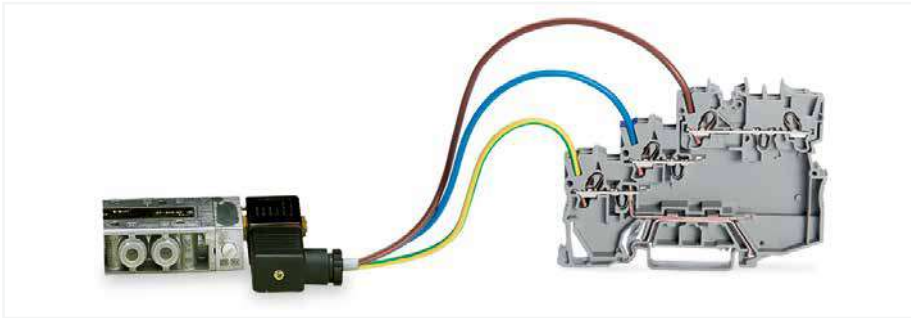

3-conductor actuator LED terminal block with a connected actuator

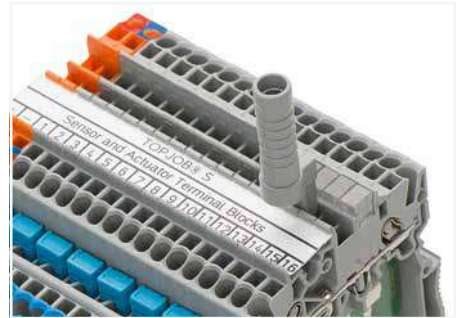

Testing via test plug adapter (2009-174) (up to max. 42 V).

3-Conductor Sensor Terminal Block TOPJOB® S

1 (1.5) mm²; 2000 Series

1

Technical Data	
0.14 ... 1 (1.5) mm ² ①	24 ... 16 AWG
250 V / 4 kV / 3 ②	300 V, 15 A
I _N 13.5 A	300 V, 10 A ③
Terminal block width: 7 mm / 0.276 inch ③	
9 ... 11 mm / 0.35 ... 0.43 inch	

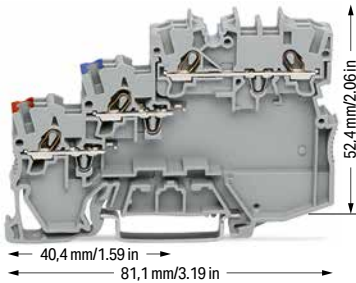

2000-5311

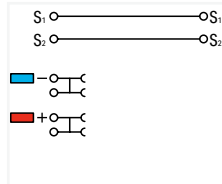

3-conductor sensor terminal block

Color	Item No.	Pack. Unit
	2000-5311	50

Technical Data	
0.14 ... 1 (1.5) mm ² ①	24 ... 16 AWG
24 VDC	24 V, 15 A
I _N 13.5 A	24 V, 10 A ③
Terminal block width: 7 mm / 0.276 inch ③	
9 ... 11 mm / 0.35 ... 0.43 inch	

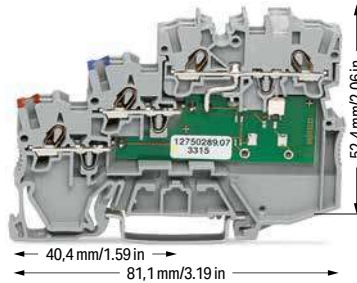

2000-5311/1102-950

2000-5311/1101-951

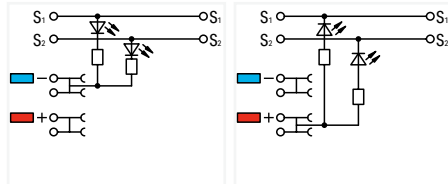

3-conductor sensor terminal block; yellow LED; for PNP (high-side) switching sensors

Color	Item No.	Pack. Unit
	2000-5311/1102-950	50

3-conductor sensor terminal block; yellow LED; for NPN (low-side) switching sensors

	2000-5311/1101-951	50
--	--------------------	----

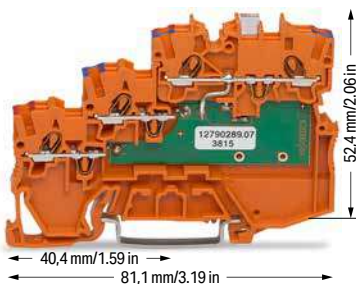

2000-5372/1102-953

2000-5372

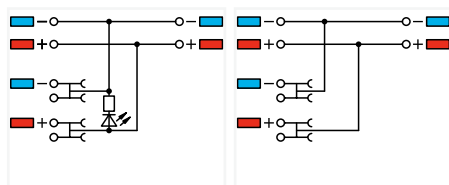

3-conductor sensor LED supply terminal block; green LED; 24 VDC

Color	Item No.	Pack. Unit
	2000-5372/1102-953	15

3-conductor sensor supply terminal block; max. 250 V

	2000-5372	15
--	-----------	----

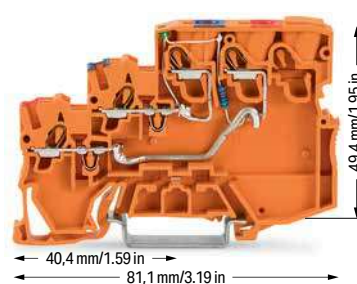

2000-5352/1102-953

2000-5352

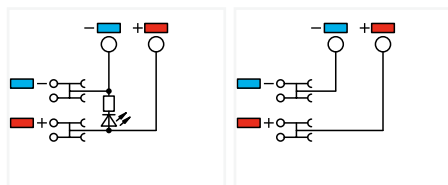

3-conductor sensor LED supply terminal block; green LED; 24 VDC control panel side: 2.5 (4) mm²; max. 28 A

Color	Item No.	Pack. Unit
	2000-5352/1102-953	50

3-conductor sensor supply terminal block; max. 250 V; control panel side: 2.5 (4) mm²; max. 28 A

	2000-5352	50
--	-----------	----

① Conductor range: 0.14 ... 1.5 mm² "s+f-st"; Push-in termination: 0.5 ... 1.5 mm² "s" and 0.5 ... 0.75 mm² "insulated ferrules; 10 mm" Depending on the conductor characteristic, a conductor with a smaller cross section can also be inserted via push-in termination.

② 250 V = rated voltage
4 kV = rated impulse voltage
3 = pollution degree (see Section 15)

③ 3.5 mm spacing per signal (2 x 3.5 mm = 7 mm)
Note:
The double spacing per pole of this terminal block series maximizes connectivity. For example, ten sensors may be connected using only five sensor terminal blocks plus a power supply terminal block.

Please observe the application notes: Jumpers, from page 182

Approvals and corresponding ratings, visit www.wago.com

Accessories; for 3-conductor terminal blocks

Appropriate marking systems:
WMB/WMB Inline/Marking strips

End and intermediate plate; 1 mm thick; for 3-conductor terminal blocks

	gray	2000-5391	100 (25)
--	------	-----------	----------

Push-in type jumper bar; insulated; I_N 13.5 A; light gray

	2-way	2000-402	25
	3-way	2000-403	25
	4-way	2000-404	25
	5-way	2000-405	25
	6-way	2000-406	25
	7-way	2000-407	25
	8-way	2000-408	25
	9-way	2000-409	25
	10-way	2000-410	25

Colored push-in type jumper bar

- red .../000-005
- blue .../000-006

Push-in type jumper bar; insulated; I_N 13.5 A; light gray

	1 to 3	2000-433	25
	1 to 4	2000-434	25
	1 to 5	2000-435	25
	1 to 6	2000-436	25
	1 to 7	2000-437	25
	1 to 8	2000-438	25
	1 to 9	2000-439	25
	1 to 10	2000-440	25

Double-deck marker carrier; pivoting

	gray	2000-121	50 (25)
--	------	----------	---------

Marking strip; plain; 11 mm wide; 50 m reel

	white	2009-110	1
--	-------	----------	---

WMB marking card; white; 10 strips with 10 markers/card; for 3.5 mm terminal block width

	plain	793-3501	5
--	-------	----------	---

Operating tool with a partially insulated shaft; type 1; (2.5 x 0.4) mm blade

		210-719	1
--	--	---------	---

4-Conductor Sensor Terminal Block TOPJOB® S

1 (1.5) mm²; 2000 Series

Technical Data	
0.14 ... 1 (1.5) mm ² ①	24 ... 16 AWG
250 V / 4 kV / 3 ②	300 V, 15 A ③
I _N 13.5 A	300 V, 10 A ④
Terminal block width: 7 mm / 0.276 inch ⑤	
9 ... 11 mm / 0.35 ... 0.43 inch	

Technical Data	
0.14 ... 1 (1.5) mm ² ①	24 ... 16 AWG
24 VDC	24 V, 15 A ③
I _N 13.5 A	24 V, 10 A ④
Terminal block width: 7 mm / 0.276 inch ⑤	
9 ... 11 mm / 0.35 ... 0.43 inch	

- ① Conductor range: 0.14 ... 1.5 mm² "s+f-st"; Push-in termination: 0.5 ... 1.5 mm² "s" and 0.5 ... 0.75 mm² "insulated ferrules; 10 mm" Depending on the conductor characteristic, a conductor with a smaller cross section can also be inserted via push-in termination.
 - ② 250 V = rated voltage
4 kV = rated impulse voltage
3 = pollution degree (see Section 15)
 - ③ 3.5 mm spacing per signal (2 x 3.5 mm = 7 mm)
Note:
The double spacing per pole of this terminal block series maximizes connectivity. For example, ten sensors may be connected using only five sensor terminal blocks plus a power supply terminal block.
- Please observe the application notes: Jumpers, from page 174
- Approvals and corresponding ratings, visit www.wago.com

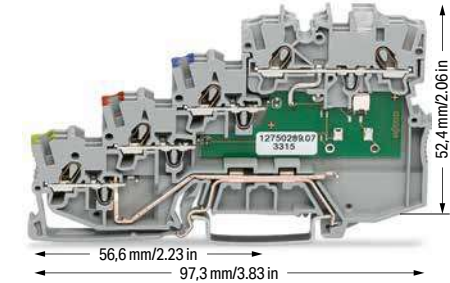
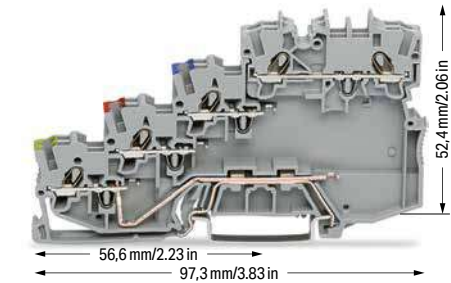

2000-5417

2000-5417/1102-950

2000-5417/1101-951

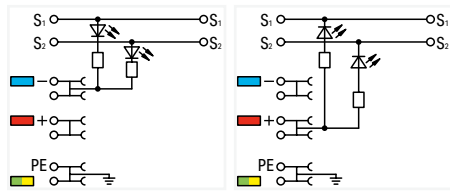
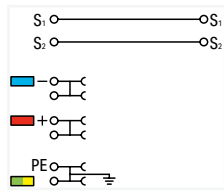

4-conductor sensor terminal block; with ground connection

4-conductor sensor LED terminal block; yellow LED; for PNP (high-side) switching sensors; with ground connection

Color	Item No.	Pack. Unit
gray	2000-5417	50

Color	Item No.	Pack. Unit
gray	2000-5417/1102-950	50

4-conductor sensor terminal block; yellow LED; for NPN (low-side) switching sensors; with ground connection

Color	Item No.	Pack. Unit
gray	2000-5417/1101-951	50

Accessories; for 4-conductor terminal blocks
Appropriate marking systems:
WMB/WMB Inline/Marking strips

End and intermediate plate; 1 mm thick; for 4-conductor terminal blocks

gray	2000-5491	100 (25)
------	-----------	----------

Push-in type jumper bar; insulated; I_N 13.5 A; light gray

2-way	2000-402	25
3-way	2000-403	25
4-way	2000-404	25
5-way	2000-405	25
6-way	2000-406	25
7-way	2000-407	25
8-way	2000-408	25
9-way	2000-409	25
10-way	2000-410	25

Colored push-in type jumper bar

red	.../000-005
blue	.../000-006
yellow-green	.../000-018

Push-in type jumper bar; insulated; I_N 13.5 A; light gray

1 to 3	2000-433	25
1 to 4	2000-434	25
1 to 5	2000-435	25
1 to 6	2000-436	25
1 to 7	2000-437	25
1 to 8	2000-438	25
1 to 9	2000-439	25
1 to 10	2000-440	25

Double-deck marker carrier; pivoting

gray	2000-121	50 (25)
------	----------	---------

Marking strip; plain; 11 mm wide; 50 m reel

white	2009-110	1
-------	----------	---

WMB marking card; white; 10 strips with 10 markers/card; for 3.5 mm terminal block width

plain	793-3501	5
-------	----------	---

Operating tool with a partially insulated shaft; type 1; (2.5 x 0.4) mm blade

	210-719	1
--	---------	---

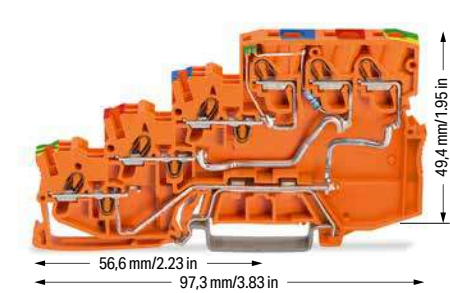
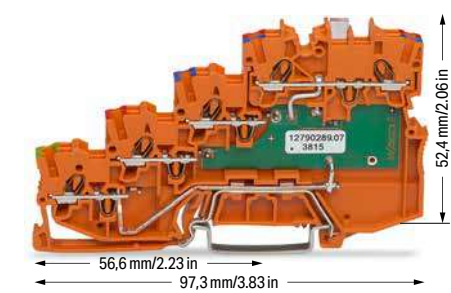

2000-5477/1102-953

2000-5477

2000-5457/1102-953

2000-5457

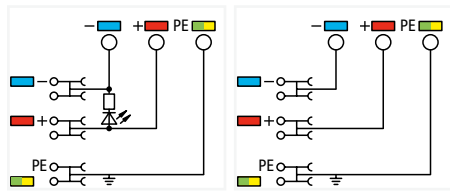
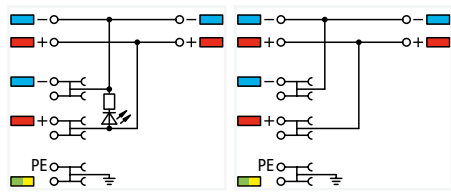

4-conductor sensor LED supply terminal block; green LED; 24 VDC; with ground connection

3-conductor sensor LED supply terminal block; green LED; 24 VDC control panel side: 2.5 (4) mm²; max. 28 A

Color	Item No.	Pack. Unit
orange	2000-5477/1102-953	15

Color	Item No.	Pack. Unit
orange	2000-5457/1102-953	15

4-conductor sensor supply terminal block; max. 250 V; internally commoned; with ground connection

4-conductor sensor supply terminal block; max. 250 V; with ground connection; control panel side: 2.5 (4) mm²; max. 28 A

Color	Item No.	Pack. Unit
orange	2000-5477	15

Color	Item No.	Pack. Unit
orange	2000-5457	15

3-Conductor Actuator Terminal Block TOPJOB® S

1 (1.5) mm²; 2000 Series

1

Technical Data	
0.14 ... 1 (1.5) mm ² ①	24 ... 16 AWG
250 V / 4 kV / 3 ②	300 V, 15 A ③
I _N 13.5 A	300 V, 10 A ④
Terminal block width: 7 mm / 0.276 inch ⑤	
9 ... 11 mm / 0.35 ... 0.43 inch	

Technical Data	
0.14 ... 1 (1.5) mm ² ①	24 ... 16 AWG
24 VDC	24 V, 15 A ③
I _N 13.5 A	24 V, 10 A ④
Terminal block width: 7 mm / 0.276 inch ⑤	
9 ... 11 mm / 0.35 ... 0.43 inch	

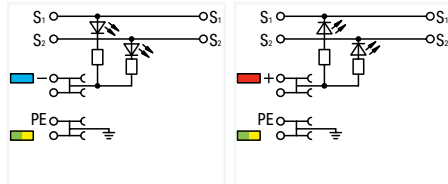
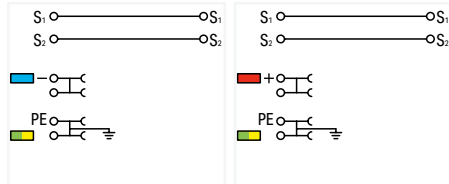
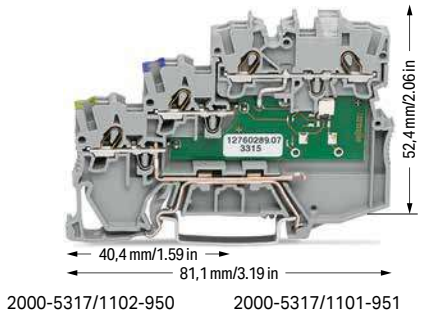
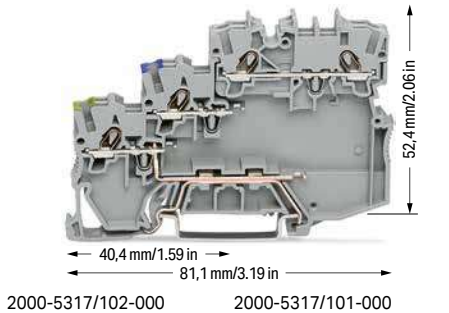

3-conductor actuator terminal block; for PNP (high-side) switching actuators; with ground connection

Color	Item No.	Pack. Unit
gray	2000-5317/102-000	50

3-conductor actuator terminal block; yellow LED; for PNP (high-side) switching actuators; with ground connection

Color	Item No.	Pack. Unit
gray	2000-5317/1102-950	50

3-conductor actuator terminal block; for NPN (low-side) switching actuators; with ground connection

Color	Item No.	Pack. Unit
gray	2000-5317/101-000	50

3-conductor actuator terminal block; yellow LED; for NPN (low-side) switching actuators; with ground connection

Color	Item No.	Pack. Unit
gray	2000-5317/1101-951	50

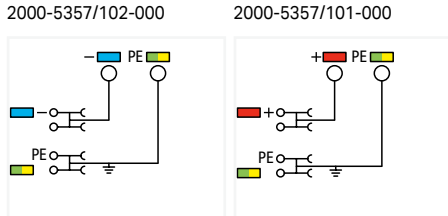
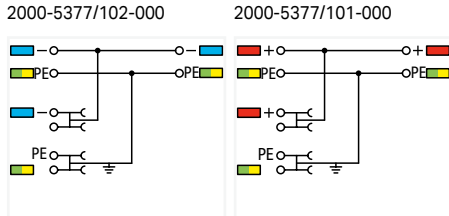
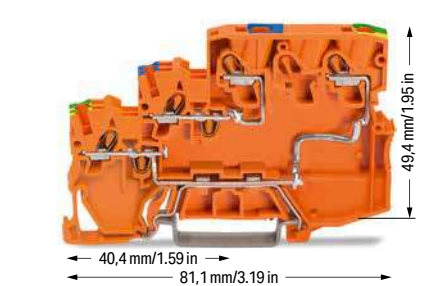
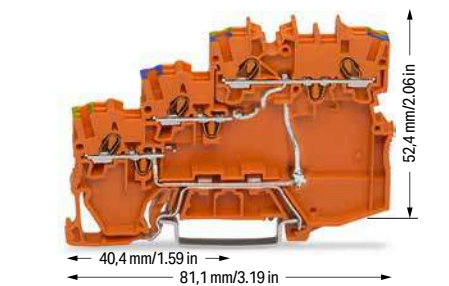

3-conductor actuator supply terminal block; max. 250 V; for PNP (high-side) switching actuators; with ground connection; internally commoned

Color	Item No.	Pack. Unit
orange	2000-5377/102-000	15

3-conductor actuator supply terminal block; max. 250 V; control panel side: 2.5 (4) mm²; max. 28 A; for PNP (high-side) switching actuators; with ground connection

Color	Item No.	Pack. Unit
orange	2000-5357/102-000	15

3-conductor actuator supply terminal block; max. 250 V; for NPN (low-side) switching actuators; with ground connection

Color	Item No.	Pack. Unit
orange	2000-5377/101-000	15

3-conductor actuator supply terminal block; max. 250 V; control panel side: 2.5 (4) mm²; max. 28 A; for NPN (low-side) switching actuators; with ground connection

Color	Item No.	Pack. Unit
orange	2000-5357/101-000	15

① Conductor range: 0.14 ... 1.5 mm² "s+f-st"; Push-in termination: 0.5 ... 1.5 mm² "s" and 0.5 ... 0.75 mm² "insulated ferrules; 10 mm" Depending on the conductor characteristic, a conductor with a smaller cross section can also be inserted via push-in termination.

② 250 V = rated voltage
4 kV = rated impulse voltage
3 = pollution degree (see Section 15)

③ 3.5 mm spacing per signal (2 x 3.5 mm = 7 mm)
Note:
The double spacing per pole of this terminal block series maximizes connectivity. For example, ten sensors may be connected using only five sensor terminal blocks plus a power supply terminal block.

Please observe the application notes: Jumpers, from page 182

Approvals and corresponding ratings, visit www.wago.com

Accessories; for 3-conductor terminal blocks
Appropriate marking systems:
WMB/WMB Inline/Marking strips

End and intermediate plate; 1 mm thick; for 3-conductor terminal blocks

gray	2000-5391	100 (25)
------	-----------	----------

Push-in type jumper bar; insulated; I_N 13.5 A; light gray

2-way	2000-402	25
3-way	2000-403	25
4-way	2000-404	25
5-way	2000-405	25
6-way	2000-406	25
7-way	2000-407	25
8-way	2000-408	25
9-way	2000-409	25
10-way	2000-410	25

Colored push-in type jumper bar

red	.../000-005
blue	.../000-006
yellow-green	.../000-018

Push-in type jumper bar; insulated; I_N 13.5 A; light gray

1 to 3	2000-433	25
1 to 4	2000-434	25
1 to 5	2000-435	25
1 to 6	2000-436	25
1 to 7	2000-437	25
1 to 8	2000-438	25
1 to 9	2000-439	25
1 to 10	2000-440	25

Double-deck marker carrier; pivoting

gray	2000-121	50 (25)
------	----------	---------

Marking strip; plain; 11 mm wide; 50 m reel

white	2009-110	1
-------	----------	---

WMB marking card; white; 10 strips with 10 markers/card; for 3.5 mm terminal block width

plain	793-3501	5
-------	----------	---

Operating tool with a partially insulated shaft; type 1; (2.5 x 0.4) mm blade

	210-719	1
--	---------	---

4-Conductor Sensor Terminal Block and 3-Conductor Actuator Terminal Block TOPJOB® S 1 (1.5) mm²; 2000 Series

Technical Data	
0.14 ... 1 (1.5) mm ² ❶	24 ... 16 AWG
250 V / 4 kV / 3 ❷	300 V, 15 A ❸
I _N 13.5 A	300 V, 10 A ❸
Terminal block width: 7 mm / 0.276 inch ❸	
9 ... 11 mm / 0.35 ... 0.43 inch	

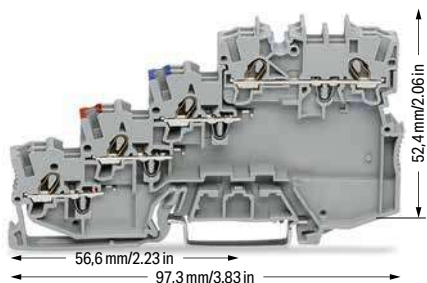

2000-5410

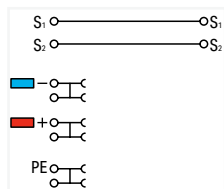

4-conductor sensor terminal block; with ground via push-in type jumper bar

Color	Item No.	Pack. Unit
○ gray	2000-5410	50

Technical Data	
0.14 ... 1 (1.5) mm ² ❶	24 ... 16 AWG
24 VDC	24 V, 15 A ❸
I _N 13.5 A	24 V, 10 A ❸
Terminal block width: 7 mm / 0.276 inch ❸	
9 ... 11 mm / 0.35 ... 0.43 inch	

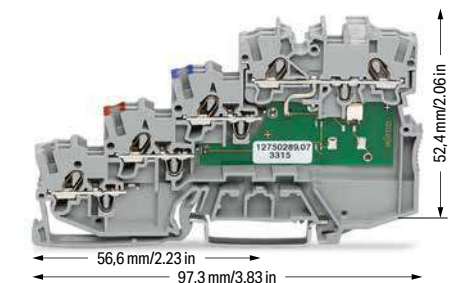

2000-5410/1102-950 2000-5410/1101-951

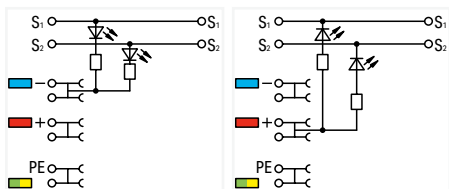

4-conductor sensor LED terminal block; yellow LED; for PNP (high-side) switching sensors; with ground via push-in type jumper bar

Color	Item No.	Pack. Unit
○ gray	2000-5410/1102-950	50

4-conductor sensor LED terminal block; yellow LED; for NPN (low-side) switching sensors; with ground via push-in type jumper bar

○ gray	2000-5410/1101-951	50
--------	--------------------	----

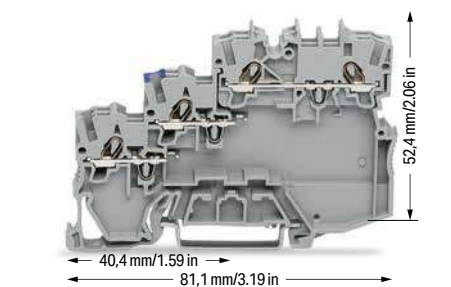

2000-5310/102-000 2000-5310/101-000

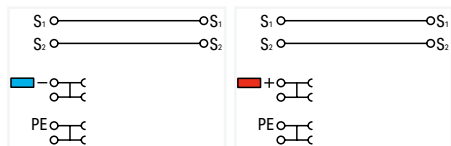

3-conductor actuator terminal block; for PNP (high-side) switching actuators; with ground via push-in type jumper bar

Color	Item No.	Pack. Unit
○ gray	2000-5310/102-000	50

3-conductor actuator terminal block; for NPN (low-side) switching actuators; with ground via push-in type jumper bar

○ gray	2000-5310/101-000	50
--------	-------------------	----

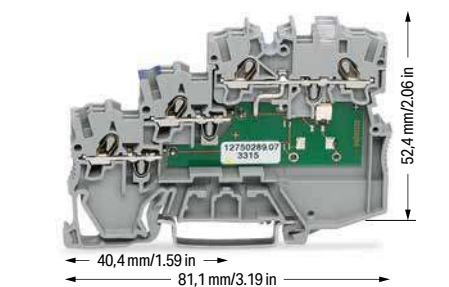

2000-5310/1102-950 2000-5310/1101-951

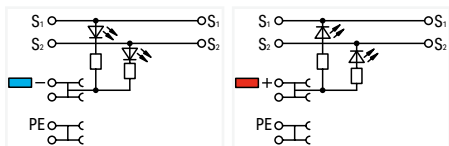

3-conductor actuator terminal block; yellow LED; for PNP (high-side) switching actuators; with ground via push-in type jumper bar

Color	Item No.	Pack. Unit
○ gray	2000-5310/1102-950	50

3-conductor actuator terminal block; yellow LED; for NPN (low-side) switching actuators; with ground via push-in type jumper bar

○ gray	2000-5310/1101-951	50
--------	--------------------	----

❶ Conductor range: 0.14 ... 1.5 mm² "s+st"; Push-in termination: 0.5 ... 1.5 mm² "s" and 0.5 ... 0.75 mm² "insulated ferrules; 10 mm" Depending on the conductor characteristic, a conductor with a smaller cross section can also be inserted via push-in termination.

❷ 250 V = rated voltage
4 kV = rated impulse voltage
3 = pollution degree (see Section 15)

❸ 3.5 mm spacing per signal (2 x 3.5 mm = 7 mm)
Note:
The double spacing per pole of this terminal block series maximizes connectivity. For example, ten sensors may be connected using only five sensor terminal blocks plus a power supply terminal block.

Please observe the application notes: Jumpers, from page 182

Approvals and corresponding ratings, visit www.wago.com

Accessories; for 4-conductor terminal blocks
Appropriate marking systems:
WMB/WMB Inline/Marking strips

End and intermediate plate; 1 mm thick; for 4-conductor terminal blocks

gray	2000-5491	100 (25)
------	-----------	----------

Push-in type jumper bar; insulated; I_N 13.5 A; light gray

2-way	2000-402	25
3-way	2000-403	25
4-way	2000-404	25
5-way	2000-405	25
6-way	2000-406	25
7-way	2000-407	25
8-way	2000-408	25
9-way	2000-409	25
10-way	2000-410	25

Colored push-in type jumper bar

red	.../000-005
blue	.../000-006
yellow-green	.../000-018

Push-in type jumper bar; insulated; I_N 13.5 A; light gray

1 to 3	2000-433	25
1 to 4	2000-434	25
1 to 5	2000-435	25
1 to 6	2000-436	25
1 to 7	2000-437	25
1 to 8	2000-438	25
1 to 9	2000-439	25
1 to 10	2000-440	25

Double-deck marker carrier; pivoting

gray	2000-121	50 (25)
------	----------	---------

Marking strip; plain; 11 mm wide; 50 m reel

white	2009-110	1
-------	----------	---

WMB marking card; white; 10 strips with 10 markers/card; for 3.5 mm terminal block width

plain	793-3501	5
-------	----------	---

Operating tool with a partially insulated shaft; type 1; (2.5 x 0.4) mm blade

	210-719	1
--	---------	---

PUSH-IN CAGE CLAMP®

Sensor Terminal Blocks and Actuator Terminal Blocks TOPJOB® S; with Pluggable Signal Level 2020 Series

Description and Installation

1

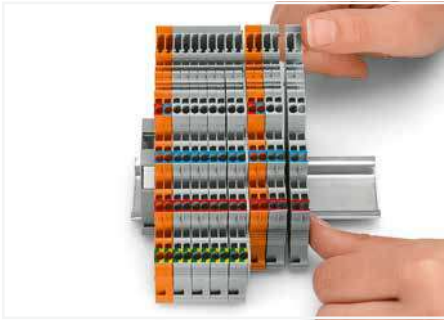

Snap individual terminal blocks onto the DIN-rail and slide together.



Separate terminal block assembly and slide individual terminal blocks laterally using an operating tool.

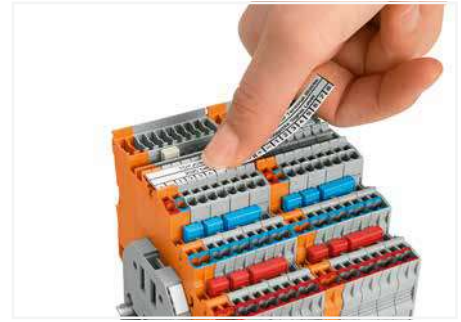

Labeling terminal blocks via marking strips (2009-110) or 3.5 mm wide WMB markers (793-35xx) – from the top or the side.

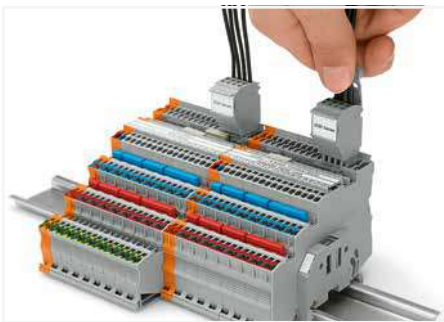

Removing a female plug via conductor bundle provided with strain relief plate.

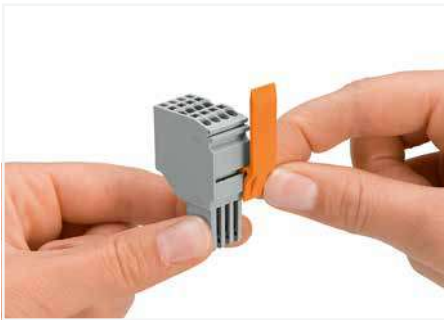

Slide the locking lever into position.

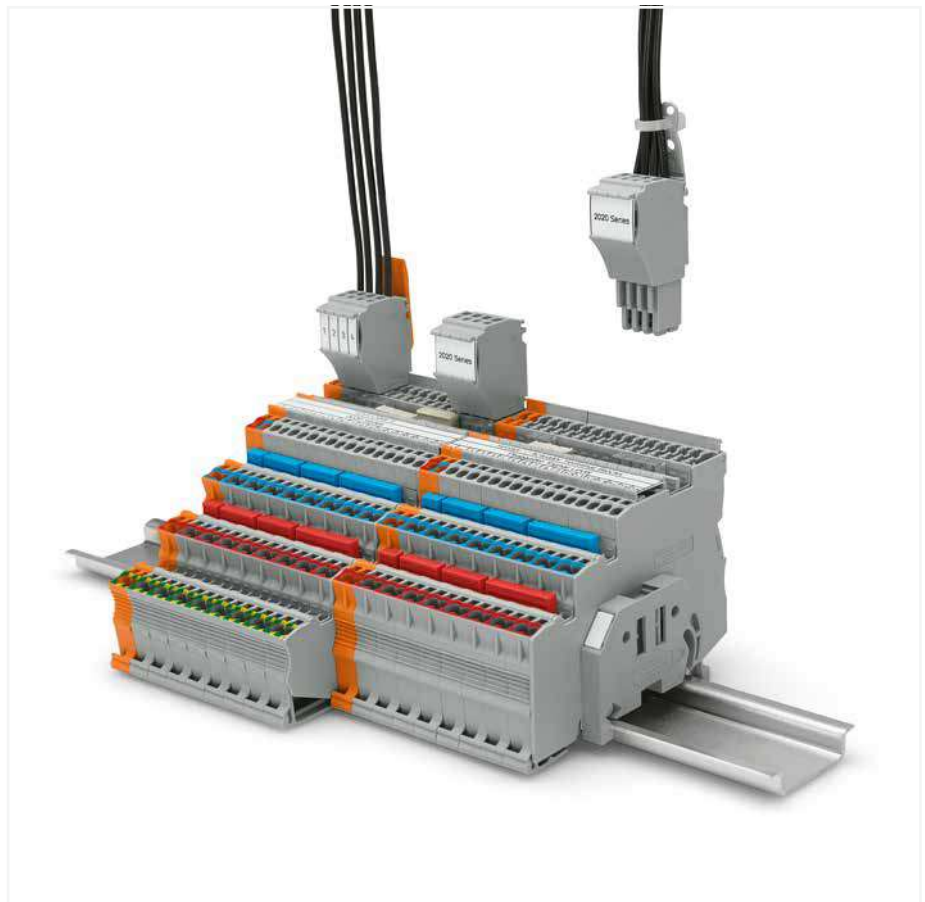

Testing via testing tap (2009-182) or test plug adapter (2009-174) (up to max. 42 V).



Insert coding pin into the corresponding slot and twist it off.



Remove the coding finger using a cutting tool.

3-Conductor Sensor Terminal Block TOPJOB® S; with Pluggable Signal Level 1 (1.5) mm²; 2020 Series

Technical Data	
0.14 ... 1 (1.5) mm ² ①	24 ... 16 AWG
250 V / 4 kV / 3 ②	300 V, 15 A
I _N 13.5 A	300 V, 10 A
Terminal block width: 7 mm / 0.276 inch ③	
9 ... 11 mm / 0.35 ... 0.43 inch	

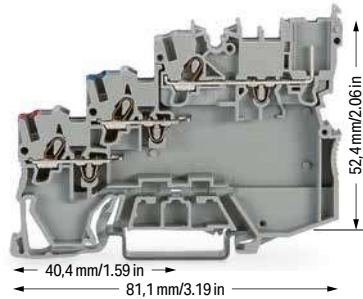

2020-5311

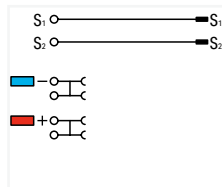

3-conductor sensor terminal block; with pluggable signal level

Color	Item No.	Pack. Unit
gray	2020-5311	50

Note:
According to EN 61984, pluggable connectors without a current interrupting capacity must not be mated or unmated when live or under load. An appropriate end plate must be applied to the carrier terminal blocks after each female plug.

Technical Data	
0.14 ... 1 (1.5) mm ² ①	24 ... 16 AWG
24 VDC	24 V, 15 A
I _N 13.5 A	24 V, 10 A
Terminal block width: 7 mm / 0.276 inch ③	
9 ... 11 mm / 0.35 ... 0.43 inch	

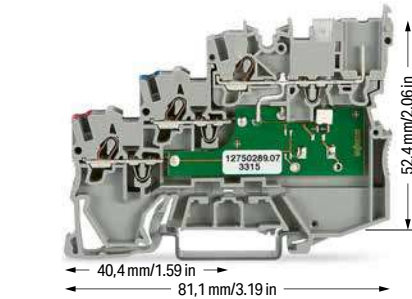

2020-5311/1102-950

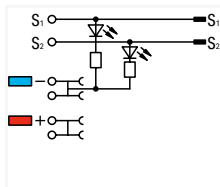

3-conductor sensor terminal block; yellow LED; for PNP (high-side) switching sensors; with pluggable signal level

Color	Item No.	Pack. Unit
gray	2020-5311/1102-950	50

- ① Conductor range: 0.14 ... 1.5 mm² "s-f-st"; Push-in termination: 0.5 ... 1.5 mm² "s" and 0.5 ... 0.75 mm² "insulated ferrules; 10 mm" Depending on the conductor characteristic, a conductor with a smaller cross section can also be inserted via push-in termination.
 - ② 250 V = rated voltage
4 kV = rated impulse voltage
3 = pollution degree (see Section 15)
 - ③ 3.5 mm spacing per signal (2 x 3.5 mm = 7 mm)
Note:
The double spacing per pole of this terminal block series maximizes connectivity. For example, ten sensors may be connected using only five sensor terminal blocks plus a power supply terminal block.
- Please observe the application notes:
Jumpers, from page 182
- Approvals and corresponding ratings, visit www.wago.com

Accessories; for 3-conductor terminal blocks
Appropriate marking systems:
WMB/WMB Inline/Marking strips

End and intermediate plate; 1 mm thick; for 3-conductor terminal blocks

	gray	2020-5391	100 (25)
--	------	-----------	----------

Push-in type jumper bar; insulated; I_N 13.5 A; light gray

	2-way	2000-402	25
	3-way	2000-403	25
	4-way	2000-404	25
	5-way	2000-405	25
	6-way	2000-406	25
	7-way	2000-407	25
	8-way	2000-408	25
	9-way	2000-409	25
	10-way	2000-410	25

Colored push-in type jumper bar

- red .../000-005
- blue .../000-006

Push-in type jumper bar; insulated; I_N 13.5 A; light gray

	1 to 3	2000-433	25
	1 to 4	2000-434	25
	1 to 5	2000-435	25
	1 to 6	2000-436	25
	1 to 7	2000-437	25
	1 to 8	2000-438	25
	1 to 9	2000-439	25
	1 to 10	2000-440	25

Carrier with 6 coding pins; for coding female plugs

	orange	2020-100	100 (25)
--	--------	----------	----------

1-conductor female plug

	gray	2020-102	100
--	------	----------	-----

2-conductor female plug

	gray	2020-202	100
--	------	----------	-----

Test plug adapter; for 4 mm Ø test plug

	gray	2009-174	100 (25)
--	------	----------	----------

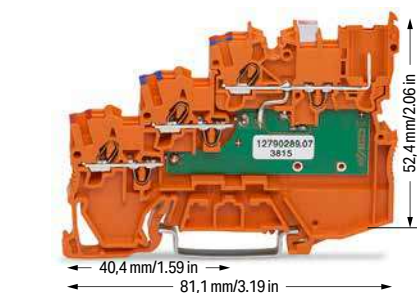

2020-5372/1102-953

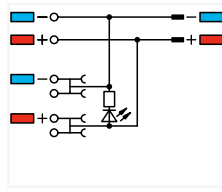

3-conductor sensor LED supply terminal block; green LED; 24 VDC; with pluggable signal level

Color	Item No.	Pack. Unit
orange	2020-5372/1102-953	15

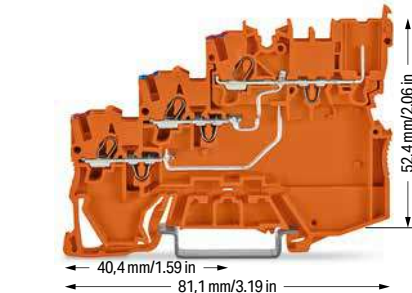

2020-5372

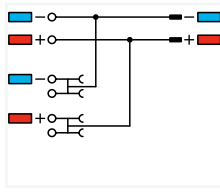

3-conductor sensor supply terminal block; max. 250 V; internally commoned; with pluggable signal level

Color	Item No.	Pack. Unit
orange	2020-5372	50

4-Conductor Sensor Terminal Block TOPJOB® S; with Pluggable Signal Level 1 (1.5) mm²; 2020 Series

1

Technical Data	
0.14 ... 1 (1.5) mm ² ①	24 ... 16 AWG
250 V / 4 kV / 3 ②	300 V, 15 A ③
I _N 13.5 A	300 V, 10 A ④
Terminal block width: 7 mm / 0.276 inch ⑤	
9 ... 11 mm / 0.35 ... 0.43 inch	



2020-5417

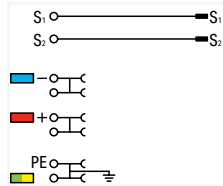

4-conductor sensor terminal block; with ground connection; with pluggable signal level

Color	Item No.	Pack. Unit
gray	2020-5417	50

Note:
According to EN 61984, pluggable connectors without a current interrupting capacity must not be mated or unmated when live or under load. An appropriate end plate must be applied to the carrier terminal blocks after each female plug.

Technical Data	
0.14 ... 1 (1.5) mm ² ①	24 ... 16 AWG
24 VDC	24 V, 15 A ③
I _N 13.5 A	24 V, 10 A ④
Terminal block width: 7 mm / 0.276 inch ⑤	
9 ... 11 mm / 0.35 ... 0.43 inch	

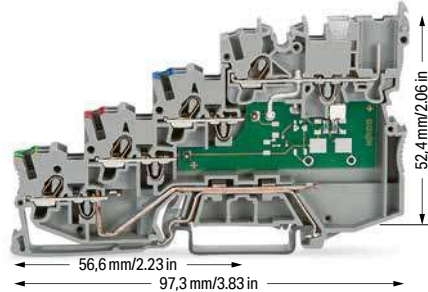

2020-5417/1102-950

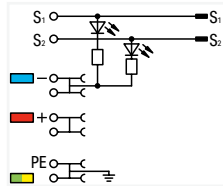

4-conductor sensor terminal block; yellow LED; for PNP (high-side) switching sensors; with ground connection; with pluggable signal level

Color	Item No.	Pack. Unit
gray	2020-5417/1102-950	50

- ① Conductor range: 0.14 ... 1.5 mm² "s+f-st"; Push-in termination: 0.5 ... 1.5 mm² "s" and 0.5 ... 0.75 mm² "insulated ferrules; 10 mm" Depending on the conductor characteristic, a conductor with a smaller cross section can also be inserted via push-in termination.
 - ② 250 V = rated voltage
4 kV = rated impulse voltage
3 = pollution degree (see Section 15)
 - ③ 3.5 mm spacing per signal (2 x 3.5 mm = 7 mm)
Note:
The double spacing per pole of this terminal block series maximizes connectivity. For example, ten sensors may be connected using only five sensor terminal blocks plus a power supply terminal block.
- Please observe the application notes: Jumpers, from page 182
- Approvals and corresponding ratings, visit www.wago.com

Accessories; for 4-conductor terminal blocks
Appropriate marking systems:
WMB/WMB Inline/Marking strips

End and intermediate plate; 1 mm thick; for 4-conductor terminal blocks

gray	2020-5491	100 (25)
------	-----------	----------

Push-in type jumper bar; insulated; I_N 13.5 A; light gray

2-way	2000-402	25
3-way	2000-403	25
4-way	2000-404	25
5-way	2000-405	25
6-way	2000-406	25
7-way	2000-407	25
8-way	2000-408	25
9-way	2000-409	25
10-way	2000-410	25

Colored push-in type jumper bar

red	.../000-005
blue	.../000-006
yellow-green	.../000-018

Push-in type jumper bar; insulated; I_N 13.5 A; light gray

1 to 3	2000-433	25
1 to 4	2000-434	25
1 to 5	2000-435	25
1 to 6	2000-436	25
1 to 7	2000-437	25
1 to 8	2000-438	25
1 to 9	2000-439	25
1 to 10	2000-440	25

Carrier with 6 coding pins; for coding female plugs

orange	2020-100	100 (25)
--------	----------	----------

1-conductor female plug

gray	2020-102	100
------	----------	-----

2-conductor female plug

gray	2020-202	100
------	----------	-----

Test plug adapter; for 4 mm Ø test plug

gray	2009-174	100 (25)
------	----------	----------

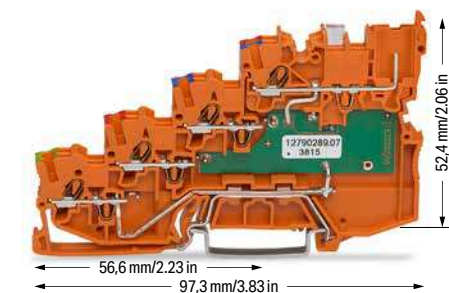

2020-5477/1102-953

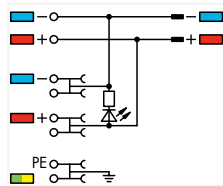

4-conductor sensor LED supply terminal block; green LED; 24 VDC; with ground connection; with pluggable signal level

Color	Item No.	Pack. Unit
orange	2020-5477/1102-953	15

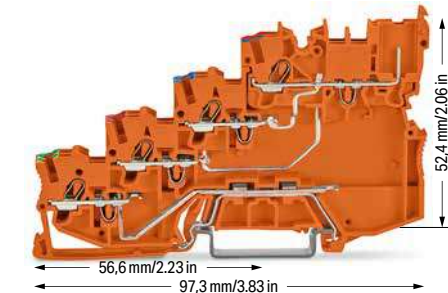

2020-5477

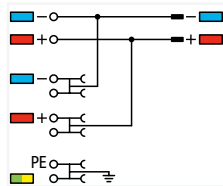

4-conductor sensor supply terminal block; max. 250 V; internally commoned; with ground connection; with pluggable signal level

Color	Item No.	Pack. Unit
orange	2020-5477	50

3-Conductor Actuator Terminal Block TOPJOB® S; with Pluggable Signal Level 1 (1.5) mm²; 2020 Series

Technical Data	
0.14 ... 1 (1.5) mm ² ①	24 ... 16 AWG
250 V / 4 kV / 3 ②	300 V, 15 A
I _N 13.5 A	300 V, 10 A
Terminal block width: 7 mm / 0.276 inch ③	
9 ... 11 mm / 0.35 ... 0.43 inch	

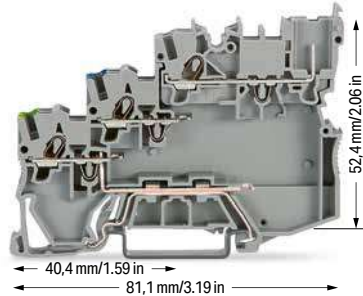

2020-5317/102-000

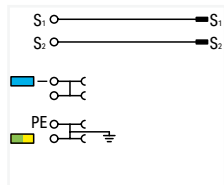

3-conductor actuator terminal block; for PNP (high-side) switching actuators; with ground connection; with pluggable signal level

Color	Item No.	Pack. Unit
gray	2020-5317/102-000	50

Note:

According to EN 61984, pluggable connectors without a current interrupting capacity must not be mated or unmated when live or under load. An appropriate end plate must be applied to the carrier terminal blocks after each female plug.

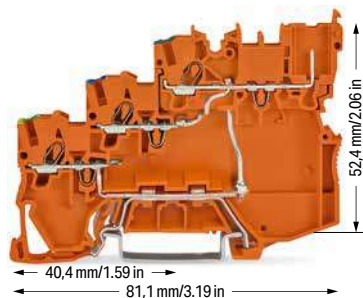

2020-5377/102-000

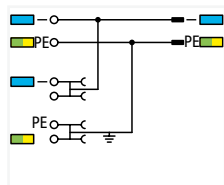

3-conductor actuator supply terminal block; for PNP (high-side) switching actuators; with ground connection; internally commoned; with pluggable signal level

Color	Item No.	Pack. Unit
orange	2020-5377/102-000	15

Technical Data	
0.14 ... 1 (1.5) mm ² ①	24 ... 16 AWG
24 VDC	24 V, 15 A
I _N 13.5 A	24 V, 10 A
Terminal block width: 7 mm / 0.276 inch ③	
9 ... 11 mm / 0.35 ... 0.43 inch	

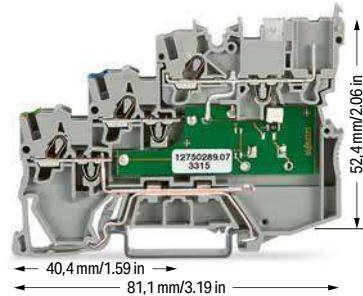

2020-5317/1102-950

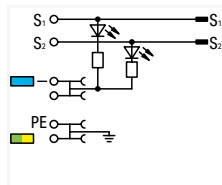

3-conductor actuator terminal block; yellow LED; for PNP (high-side) switching actuators; with ground connection; with pluggable signal level

Color	Item No.	Pack. Unit
gray	2020-5317/1102-950	50

① Conductor range: 0.14 ... 1.5 mm² "s-ft"; Push-in termination: 0.5 ... 1.5 mm² "s" and 0.5 ... 0.75 mm² "insulated ferrules; 10 mm" Depending on the conductor characteristic, a conductor with a smaller cross section can also be inserted via push-in termination.

② 250 V = rated voltage
4 kV = rated impulse voltage
3 = pollution degree (see Section 15)

③ 3.5 mm spacing per signal (2 x 3.5 mm = 7 mm)
Note:
The double spacing per pole of this terminal block series maximizes connectivity. For example, ten sensors may be connected using only five sensor terminal blocks plus a power supply terminal block.

Please observe the application notes: Jumpers, from page 182

Approvals and corresponding ratings, visit www.wago.com

Accessories; for 3-conductor terminal blocks
Appropriate marking systems:
WMB/WMB Inline/Marking strips

End and intermediate plate; 1 mm thick; for 3-conductor terminal blocks

	gray	2020-5391	100 (25)
--	------	-----------	----------

Push-in type jumper bar; insulated; I_N 13.5 A; light gray

	2-way	2000-402	25
	3-way	2000-403	25
	4-way	2000-404	25
	5-way	2000-405	25
	6-way	2000-406	25
	7-way	2000-407	25
	8-way	2000-408	25
	9-way	2000-409	25
	10-way	2000-410	25

Colored push-in type jumper bar

	red	.../000-005
	blue	.../000-006
	yellow-green	.../000-018

Push-in type jumper bar; insulated; I_N 13.5 A; light gray

	1 to 3	2000-433	25
	1 to 4	2000-434	25
	1 to 5	2000-435	25
	1 to 6	2000-436	25
	1 to 7	2000-437	25
	1 to 8	2000-438	25
	1 to 9	2000-439	25
	1 to 10	2000-440	25

Carrier with 6 coding pins; for coding female plugs

	orange	2020-100	100 (25)
--	--------	----------	----------

1-conductor female plug

	gray	2020-102	100
--	------	----------	-----

2-conductor female plug

	gray	2020-202	100
--	------	----------	-----

Test plug adapter; for 4 mm Ø test plug

	gray	2009-174	100 (25)
--	------	----------	----------

Diode Terminal Block, LED Terminal Block TOPJOB® S

1.5 (2.5) mm²; 2001 Series

1

Technical Data	
0.25 ... 1.5 (2.5) mm ² ①	22 ... 14 AWG
U _N 250 V; U _{RM} 1000 V	
1N4007 - 0.5 A continuous current	
Terminal block width: 4.2 mm / 0.165 inch	
9 ... 11 mm / 0.35 ... 0.43 inch	

Technical Data	
0.25 ... 1.5 (2.5) mm ² ①	22 ... 14 AWG
U _N 250 V; U _{RM} 1000 V	
1N4007 - 0.5 A continuous current	
Terminal block width: 4.2 mm / 0.165 inch	
9 ... 11 mm / 0.35 ... 0.43 inch	

Technical Data	
0.25 ... 1.5 (2.5) mm ² ①	22 ... 14 AWG
24 VDC	
I _F 0.025 A max.	
Terminal block width: 4.2 mm / 0.165 inch	
9 ... 11 mm / 0.35 ... 0.43 inch	

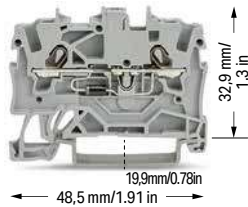

2001-1211/1000-411 2001-1211/1000-410

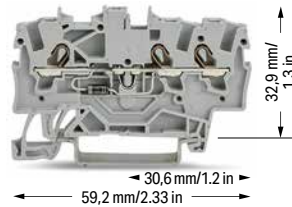

2001-1311/1000-411 2001-1311/1000-410

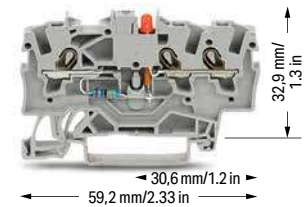

2001-1321/1000-434 2001-1321/1000-413

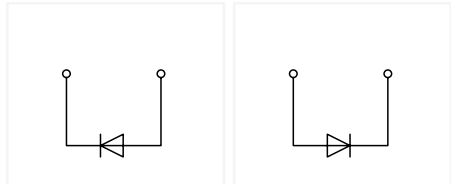

2-conductor diode terminal block; with 1N4007 diode

	Item No.	Pack. Unit
○ anode right	2001-1211/1000-411	100
○ anode left	2001-1211/1000-410	100

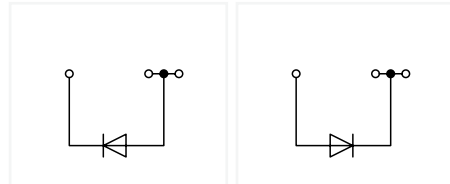

3-conductor diode terminal block; with 1N4007 diode

	Item No.	Pack. Unit
○ anode right	2001-1311/1000-411	100
○ anode left	2001-1311/1000-410	100

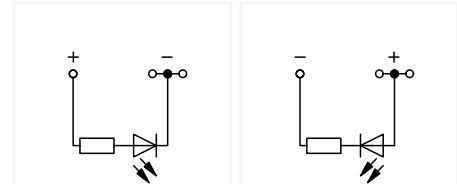

3-conductor LED terminal block; with red LED
Notice: This LED terminal block cannot be commoned with push-in type jumper bars.

	Item No.	Pack. Unit
○ anode left	2001-1321/1000-434	100
○ anode right	2001-1321/1000-413	100

Other terminal blocks with the same profile:		
Through	2001-1201	Page 54

Other terminal blocks with the same profile:		
Through	2001-1301	Page 54

Other terminal blocks with the same profile:		
Through	2001-1301	Page 54

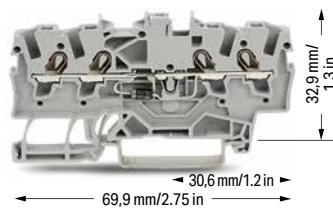

2001-1411/1000-411 2001-1411/1000-410



2001-1421/1000-434 2001-1421/1000-413

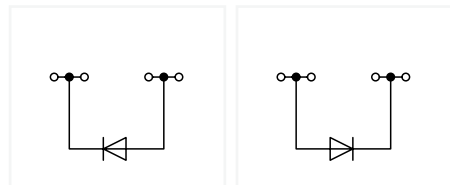

4-conductor diode terminal block; with 1N4007 diode

	Item No.	Pack. Unit
○ anode right	2001-1411/1000-411	100
○ anode left	2001-1411/1000-410	100

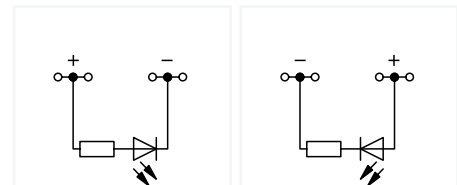

4-conductor LED terminal block; with red LED
Notice: This LED terminal block cannot be commoned with push-in type jumper bars.

	Item No.	Pack. Unit
○ anode left	2001-1421/1000-434	100
○ anode right	2001-1421/1000-413	100

Other terminal blocks with the same profile:		
Through	2001-1401	Page 54

Other terminal blocks with the same profile:		
Through	2001-1401	Page 54

Diode Terminal Blocks and LED Terminal Blocks TOPJOB® S Circuit Configuration Examples

① Conductor range: 0.25 ... 2.5 mm² "s+f-st";
Push-in termination: 0.75 ... 2.5 mm² "s" and
0.75 ... 1.5 mm² "insulated ferrules; 12 mm"
Depending on the conductor characteristic, a conduc-
tor with a smaller cross section can also be inserted
via push-in termination.

Approvals and corresponding ratings,
visit www.wago.com

Accessories; 2001 Series
Appropriate marking systems:
WMB/WMB Inline/Marking strips

Insulation stop; 5 pcs/strip; 0.25 ... 0.5 mm²
light gray 2001-171 200 (25)



Push-in type jumper bar; insulated; I_n 17.5 A; light gray

2-way	2001-402	25
3-way	2001-403	25
4-way	2001-404	25
5-way	2001-405	25
6-way	2001-406	25
7-way	2001-407	25
8-way	2001-408	25
9-way	2001-409	25
10-way	2001-410	25



Push-in type jumper bar; insulated; I_n 17.5 A; light gray

1 to 3	2001-433	25
1 to 4	2001-434	25
1 to 5	2001-435	25
1 to 6	2001-436	25
1 to 7	2001-437	25
1 to 8	2001-438	25
1 to 9	2001-439	25
1 to 10	2001-440	25

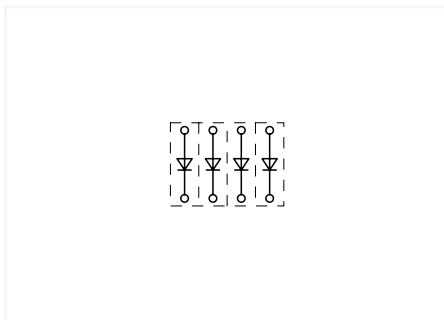

Open diode gates can be created using the following terminal blocks:
2001-1211/1000-410 or 2001-1211/1000-411



These diode terminal blocks have been specially developed for custom diode circuits, such as lamp test and collective fault signal circuits.

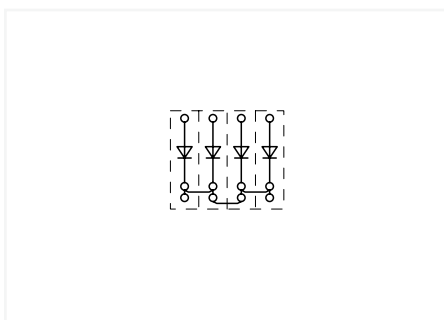

Polarized diode gates with a common cathode can be created using the following terminal blocks:
2001-1311/1000-410 or 2001-1311/1000-411

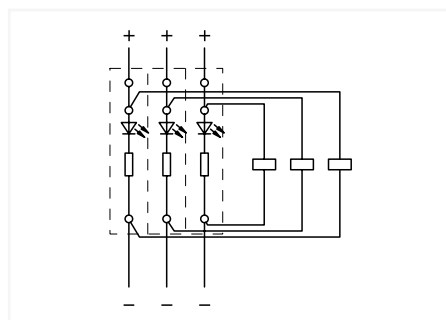

Circuit-related voltage indications can be created using the following terminal blocks:
2001-1321/1000-434 or 2001-1321/1000-413

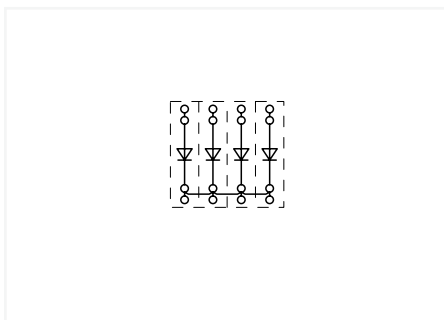

Polarized diode gates with a common cathode can be created using the following terminal blocks:
2001-1411/1000-410 or 2001-1411/1000-411

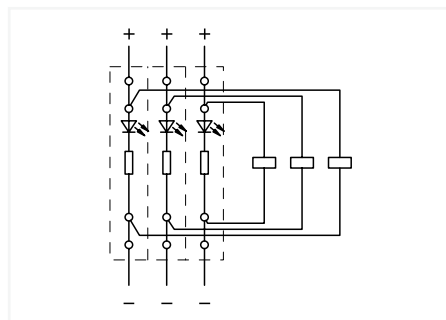

Circuit-related voltage indications can be created using the following terminal blocks:
2001-1421/1000-434 or 2001-1421/1000-413

Diode Terminal Block, LED Terminal Block TOPJOB® S

2.5 (4) mm²; 2002 Series

1

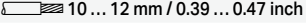
Technical Data	
0.25 ... 2.5 (4) mm ² ①	22 ... 12 AWG
U _N 250 V; U _{RM} 1000 V	
1N4007 - 0.5 A continuous current	
Terminal block width: 5.2 mm / 0.205 inch	
 10 ... 12 mm / 0.39 ... 0.47 inch	

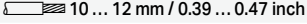
Technical Data	
0.25 ... 2.5 (4) mm ² ①	22 ... 12 AWG
U _N 250 V; U _{RM} 1000 V	
1N4007 - 0.5 A continuous current	
Terminal block width: 5.2 mm / 0.205 inch	
 10 ... 12 mm / 0.39 ... 0.47 inch	

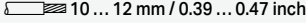
Technical Data	
0.25 ... 2.5 (4) mm ² ①	22 ... 12 AWG
24 VDC	
I _F 0.025 A max.	
Terminal block width: 5.2 mm / 0.205 inch	
 10 ... 12 mm / 0.39 ... 0.47 inch	



32,9 mm / 1.3 in

19,9 mm / 0.78 in

48,5 mm / 1.91 in

2002-1211/1000-411 2002-1211/1000-410



32,9 mm / 1.3 in

30,6 mm / 1.2 in

59,2 mm / 2.33 in

2002-1311/1000-411 2002-1311/1000-410



32,9 mm / 1.3 in

30,6 mm / 1.2 in

59,2 mm / 2.33 in

2002-1321/1000-434 2002-1321/1000-413

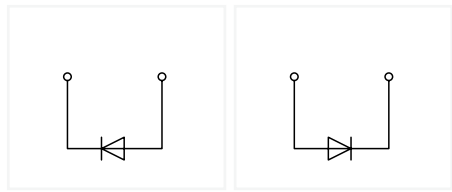

2-conductor diode terminal block; with 1N4007 diode

	Item No.	Pack. Unit
○ anode right	2002-1211/1000-411	100
○ anode left	2002-1211/1000-410	100

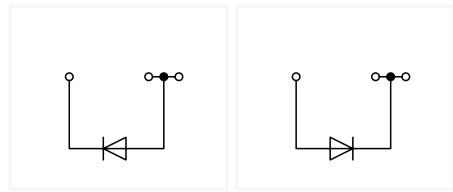

3-conductor diode terminal block; with 1N4007 diode

	Item No.	Pack. Unit
○ anode right	2002-1311/1000-411	100
○ anode left	2002-1311/1000-410	100

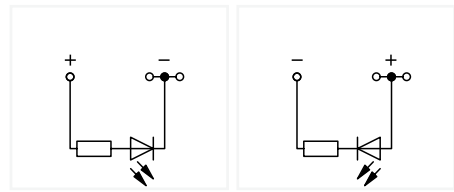

3-conductor LED terminal block; with red LED
 Notice: This LED terminal block cannot be commoned with push-in type jumper bars.

	Item No.	Pack. Unit
○ anode left	2002-1321/1000-434	100
○ anode right	2002-1321/1000-413	100

Other terminal blocks with the same profile:
 Through 2002-1201 Page 56

Other terminal blocks with the same profile:
 Through 2002-1301 Page 56

Other terminal blocks with the same profile:
 Through 2002-1301 Page 56



32,9 mm / 1.3 in

30,6 mm / 1.2 in

69,9 mm / 2.75 in

2002-1411/1000-411 2002-1411/1000-410



32,9 mm / 1.3 in

30,6 mm / 1.2 in

69,9 mm / 2.75 in

2002-1421/1000-434 2002-1421/1000-413

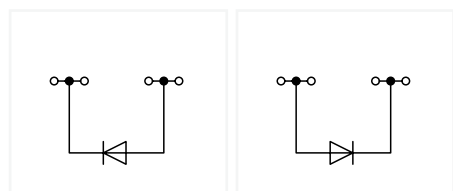

4-conductor diode terminal block; with 1N4007 diode

	Item No.	Pack. Unit
○ anode right	2002-1411/1000-411	100
○ anode left	2002-1411/1000-410	100

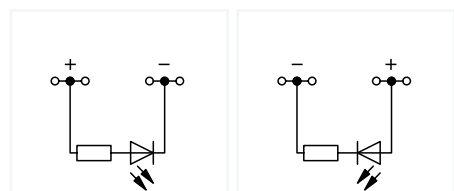

4-conductor LED terminal block; with red LED
 Notice: This LED terminal block cannot be commoned with push-in type jumper bars.

	Item No.	Pack. Unit
○ anode left	2002-1421/1000-434	100
○ anode right	2002-1421/1000-413	100

Other terminal blocks with the same profile:
 Through 2002-1401 Page 58

Other terminal blocks with the same profile:
 Through 2002-1401 Page 58

Diode Terminal Blocks and LED Terminal Blocks TOPJOB® S Circuit Configuration Examples

❶ Conductor range: 0.25 ... 4 mm² "s+f-st";
Push-in termination: 1 ... 4 mm² "s" and 1 ... 2.5 mm²
"insulated ferrules, 12 mm"
Depending on the conductor characteristic, a conductor with a smaller cross section can also be inserted via push-in termination.

Approvals and corresponding ratings, visit www.wago.com

Accessories; 2002 Series
Appropriate marking systems:
WMB/WMB Inline/Marking strips

Insulation stop; 5 pcs/strip; 0.25 ... 0.5 mm²
light gray 2002-171 200 (25)



Insulation stop; 5 pcs/strip; 0.75 ... 1 mm²
dark gray 2002-172 200 (25)



Push-in type jumper bar; insulated; I_n 25 A; light gray

2-way	2002-402	25
3-way	2002-403	25
4-way	2002-404	25
5-way	2002-405	25
6-way	2002-406	25
7-way	2002-407	25
8-way	2002-408	25
9-way	2002-409	25
10-way	2002-410	25



Push-in type jumper bar; insulated; I_n 25 A; light gray

1 to 3	2002-433	25
1 to 4	2002-434	25
1 to 5	2002-435	25
1 to 6	2002-436	25
1 to 7	2002-437	25
1 to 8	2002-438	25
1 to 9	2002-439	25
1 to 10	2002-440	25

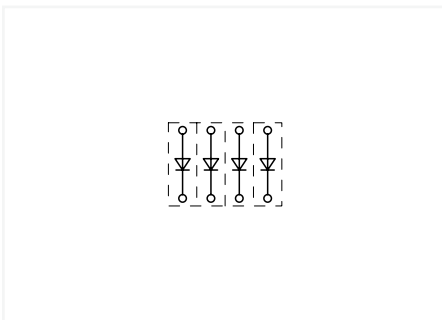

Open diode gates can be created using the following terminal blocks:
2002-1211/1000-410 or 2002-1211/1000-411



Using LED terminal blocks, monitoring units can be designed, e.g., for control and operating circuits.

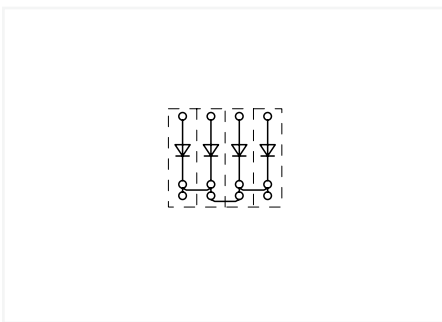

Polarized diode gates with a common cathode can be created using the following terminal blocks:
2002-1311/1000-410 or 2002-1311/1000-411

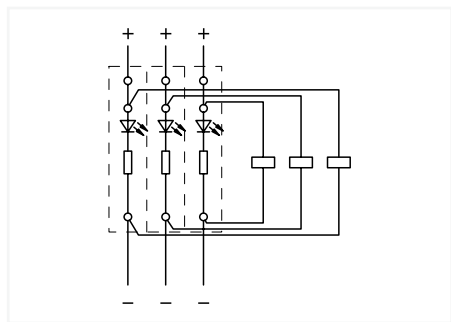

Circuit-related voltage indications can be created using the following terminal blocks:
2002-1321/1000-434 or 2002-1321/1000-413

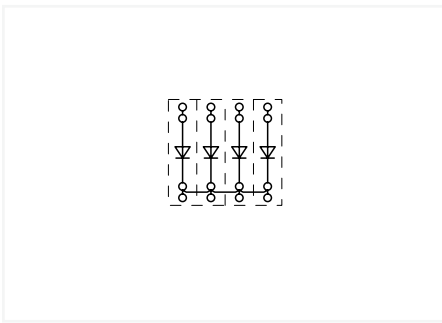

Polarized diode gates with a common cathode can be created using the following terminal blocks:
2002-1411/1000-410 or 2002-1411/1000-411

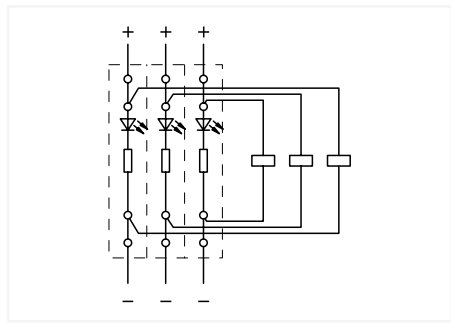



Circuit-related voltage indications can be created using the following terminal blocks:
2002-1421/1000-434 or 2002-1421/1000-413

Diode Terminal Block TOPJOB® S

4 (6) mm²; 2004 Series

1

Technical Data	
0.5 ... 4 (6) mm ² ①	20 ... 10 AWG
U _N 250 V; U _{RM} 1000 V	
1N5408 - 1.5 A continuous current	
Terminal block width: 6.2 mm / 0.244 inch	
 11 ... 13 mm / 0.43 ... 0.51 inch	

Technical Data	
0.5 ... 4 (6) mm ² ①	20 ... 10 AWG
U _N 250 V; U _{RM} 1000 V	
1N5408 - 1.5 A continuous current	
Terminal block width: 6.2 mm / 0.244 inch	
 11 ... 13 mm / 0.43 ... 0.51 inch	

Technical Data	
0.5 ... 4 (6) mm ² ①	20 ... 10 AWG
U _N 250 V; U _{RM} 1000 V	
1N5408 - 1.5 A continuous current	
Terminal block width: 6.2 mm / 0.244 inch	
 11 ... 13 mm / 0.43 ... 0.51 inch	

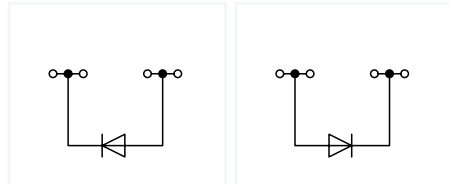
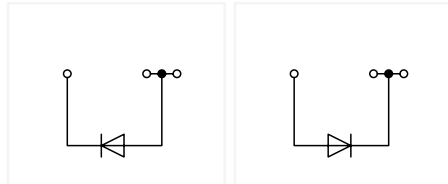
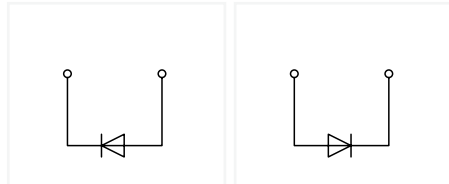
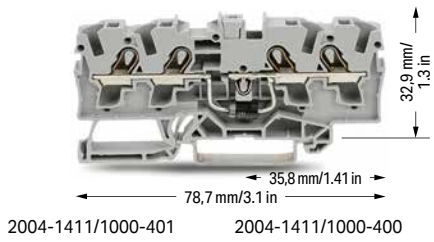
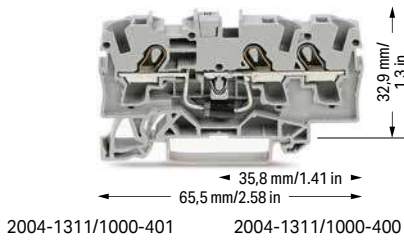
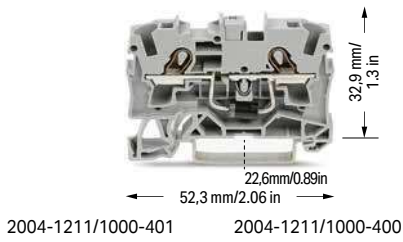

2-conductor diode terminal block; with 1N5408 diode		
	Item No.	Pack. Unit
○ anode right	2004-1211/1000-401	50
○ anode left	2004-1211/1000-400	50

3-conductor diode terminal block; with 1N5408 diode		
	Item No.	Pack. Unit
○ anode right	2004-1311/1000-401	50
○ anode left	2004-1311/1000-400	50

4-conductor diode terminal block; with 1N5408 diode		
	Item No.	Pack. Unit
○ anode right	2004-1411/1000-401	50
○ anode left	2004-1411/1000-400	50

Other terminal blocks with the same profile:		
Through	2004-1201	Page 60

Other terminal blocks with the same profile:		
Through	2004-1301	Page 60

Other terminal blocks with the same profile:		
Through	2004-1401	Page 60

Diode Terminal Blocks TOPJOB® S

Circuit Configuration Examples

① Conductor range: 0.5 ... 6 mm² "s+f-st";
 Push-in termination: 1.5 ... 6 mm² "s" and 1.5 ... 4 mm² "insulated ferrules; 12 mm"
 Depending on the conductor characteristic, a conductor with a smaller cross section can also be inserted via push-in termination.

Approvals and corresponding ratings, visit www.wago.com

Accessories; 2004 Series
 Appropriate marking systems:
 WMB/WMB Inline/Marking strips

Insulation stop; 5 pcs/strip; 0.25 ... 0.5 mm²
 light gray 2004-171 200 (25)

Insulation stop; 5 pcs/strip; 0.75 ... 1 mm²
 dark gray 2004-172 200 (25)

Push-in type jumper bar; insulated; I_N 32 A; light gray

2-way	2004-402	25
3-way	2004-403	25
4-way	2004-404	25
5-way	2004-405	25
6-way	2004-406	25
7-way	2004-407	25
8-way	2004-408	25
9-way	2004-409	25
10-way	2004-410	25

Push-in type jumper bar; insulated; I_N 32 A; light gray

1 to 3	2004-433	25
1 to 4	2004-434	25
1 to 5	2004-435	25
1 to 6	2004-436	25
1 to 7	2004-437	25
1 to 8	2004-438	25
1 to 9	2004-439	25
1 to 10	2004-440	25

Wire commoning chain; 50 connections; insulated; I_N 8 A
 black 210-103 5

Wire commoning chain; 50 connections; insulated; I_N 8 A
 blue 210-123 5

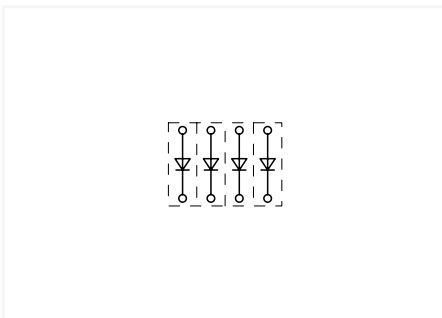

Open diode gates can be created using the following terminal blocks:
 2004-1211/1000-400 or 2004-1211/1000-401



These diode terminal blocks have been specially developed for custom diode circuits, such as lamp test and collective fault signal circuits.

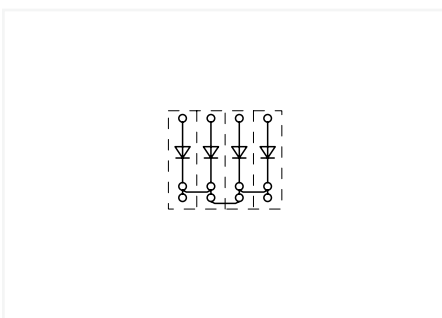

Polarized diode gates with a common cathode can be created using the following terminal blocks:
 2004-1311/1000-400 or 2004-1311/1000-401

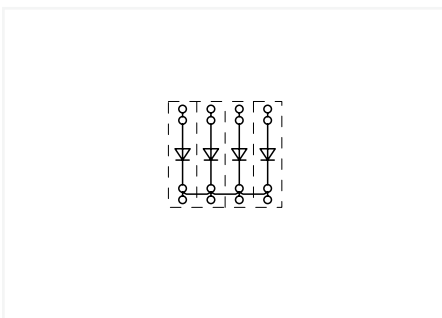

Polarized diode gates with a common cathode can be created using the following terminal blocks:
 2004-1411/1000-400 or 2004-1411/1000-401

Pluggable Diode Module TOPJOB® S on Carrier Terminal Block 2.5 (4) mm² 2002 Series

1

Technical Data
 U_N 250 V; U_{RM} 1000 V
 I_N 0.5 A
 Plug width: 5.2 mm / 0.205 inch



2002-800/1000-411

2002-800/1000-410

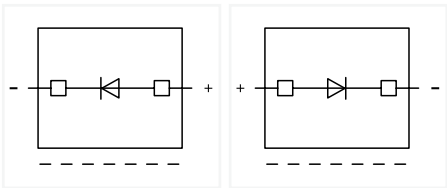

Diode module; with 1N4007 diode; max. operating temperature: 85°C; 5.2 mm wide

	Item No.	Pack. Unit
○ anode right	2002-800/1000-411	100
○ anode left	2002-800/1000-410	100

Accessories for Carrier Terminal Blocks
 Appropriate marking systems:
 WMB/Marking strips

2-conductor carrier terminal block;
 0.25 ... 2.5 (4) mm² / 22 ... 12 AWG
 Terminal block width: 5.2 mm / 0.205 inch

gray	2002-1661	50
------	-----------	----

2-conductor carrier terminal block; with push-button
 0.25 ... 2.5 (4) mm² / 22 ... 12 AWG
 Terminal block width: 5.2 mm / 0.205 inch

gray	2202-1661	50
------	-----------	----

End and intermediate plate; 1 mm thick

orange	2002-1692	100 (25)
gray	2002-1691	100 (25)

3-conductor carrier terminal block;
 0.25 ... 2.5 (4) mm² / 22 ... 12 AWG
 Terminal block width: 5.2 mm / 0.205 inch

gray	2002-1761	50
------	-----------	----

3-conductor carrier terminal block; with push-button
 0.25 ... 2.5 (4) mm² / 22 ... 12 AWG
 Terminal block width: 5.2 mm / 0.205 inch

gray	2202-1761	50
------	-----------	----

End and intermediate plate; 1 mm thick

orange	2002-1792	100 (25)
gray	2002-1791	100 (25)

Please observe the application notes:
 Jumpers, from page 182
 Marking, from page 684

Approvals and corresponding ratings,
 visit www.wago.com

Accessories for Carrier Terminal Blocks
 Appropriate marking systems:
 WMB/Marking strips

4-conductor carrier terminal block;
 0.25 ... 2.5 (4) mm² / 22 ... 12 AWG
 Terminal block width: 5.2 mm / 0.205 inch

gray	2002-1861	50
------	-----------	----

4-conductor carrier terminal block; with push-button
 0.25 ... 2.5 (4) mm² / 22 ... 12 AWG
 Terminal block width: 5.2 mm / 0.205 inch

gray	2202-1861	50
------	-----------	----

End and intermediate plate; 1 mm thick

orange	2002-1892	100 (25)
gray	2002-1891	100 (25)

2-conductor carrier terminal block;
 0.25 ... 2.5 (4) mm² / 22 ... 12 AWG
 Terminal block width: 5.2 mm / 0.205 inch

gray	2002-1961	50
------	-----------	----

2-conductor carrier terminal block; with push-button
 0.25 ... 2.5 (4) mm² / 22 ... 12 AWG
 Terminal block width: 5.2 mm / 0.205 inch

gray	2202-1961	50
------	-----------	----

End and intermediate plate; 1 mm thick

orange	2002-1992	100 (25)
gray	2002-1991	100 (25)

Push-in type wire jumper; insulated; 1.5 mm² conductor
 cross-section; I_N 18 A

L = 60 mm	2009-412	100 (10)
L = 110 mm	2009-414	100 (10)
L = 250 mm	2009-416	100 (10)

Push-in type jumper bar; insulated; I_N 25 A; light gray

2-way	2002-402	25
3-way	2002-403	25
4-way	2002-404	25
5-way	2002-405	25
6-way	2002-406	25
7-way	2002-407	25
8-way	2002-408	25
9-way	2002-409	25
10-way	2002-410	25

Push-in type jumper bar; insulated; I_N 25 A; light gray

1 to 3	2002-433	25
1 to 4	2002-434	25
1 to 5	2002-435	25
1 to 6	2002-436	25
1 to 7	2002-437	25
1 to 8	2002-438	25
1 to 9	2002-439	25
1 to 10	2002-440	25

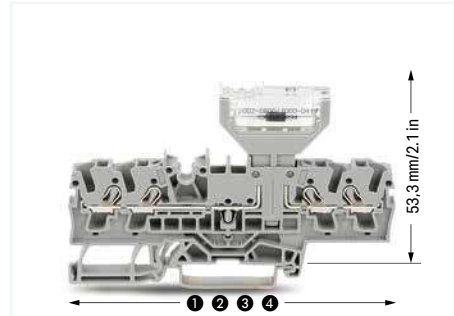

Lengths of carrier terminal blocks with a pluggable diode module:

- ① 66.1 mm / 2.62 inch for 2002-1661
- ② 76.8 mm / 3.02 inch for 2002-1761
- ③ 87.5 mm / 3.45 inch for 2002-1861
- ④ 72.9 mm / 2.87 inch for 2002-1961

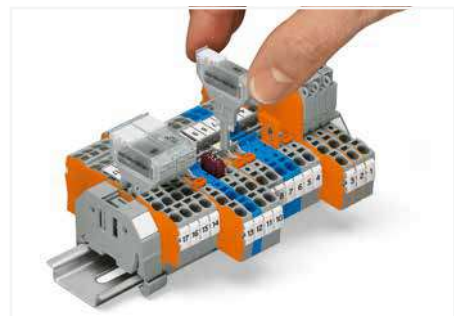

These diode modules are ideal for custom diode circuits (e.g., lamp test and collective fault signal circuits) and offer the following advantages:

- Separation into functional and wiring levels
- Polarized switching direction
- Quick and easy module replacement
- Terminal blocks/modules provide high-density wiring in a width of just 5.2 mm

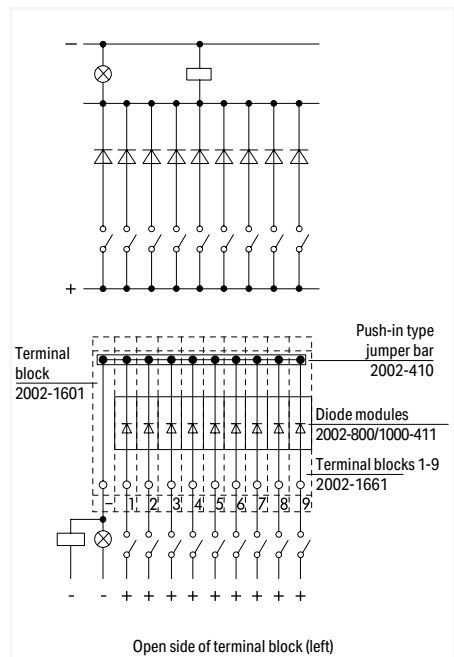

Diode module (2002-800/1000-411)
 Diode gate for collective fault indication

Pluggable Diode Module, Empty Component Plug Housing TOPJOB® S on Through Terminal Block 2.5 (4) mm²

2002 Series

Technical Data

U_N 250 V; U_{RM} 1000 V

I_N 0.5 A

Plug width: 10.4 mm / 0.409 inch



2002-880/1000-411

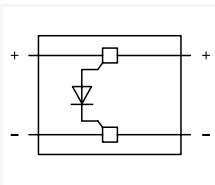

Diode module; with 1N4007 recovery diode; max. operating temperature: 85°C; 10.4 mm wide

Color	Item No.	Pack. Unit
○ gray	2002-880/1000-411	50

Empty component plug housing; type 4; 10.4 mm wide

○ gray	2002-880	50
--------	----------	----

Accessories for Through Terminal Blocks

Appropriate marking systems:
WMB/Marking strips

2-conductor through terminal block;
0.25 ... 2.5 (4) mm² / 22 ... 12 AWG
Terminal block width: 5.2 mm / 0.205 inch

gray	2002-1201	100
------	-----------	-----

2-conductor through terminal block; with push-button
0.25 ... 2.5 (4) mm² / 22 ... 12 AWG
Terminal block width: 5.2 mm / 0.205 inch

gray	2202-1201	100
------	-----------	-----

End and intermediate plate; 0.8 mm thick

orange	2002-1292	100 (25)
gray	2002-1291	100 (25)

3-conductor through terminal block;
0.25 ... 2.5 (4) mm² / 22 ... 12 AWG
Terminal block width: 5.2 mm / 0.205 inch

gray	2002-1301	100
------	-----------	-----

3-conductor through terminal block; with push-button
0.25 ... 2.5 (4) mm² / 22 ... 12 AWG
Terminal block width: 5.2 mm / 0.205 inch

gray	2202-1301	100
------	-----------	-----

End and intermediate plate; 0.8 mm thick

orange	2002-1392	100 (25)
gray	2002-1391	100 (25)

Please observe the application notes:
Jumpers, from page 182
Marking, from page 684

Approvals and corresponding ratings,
visit www.wago.com

Accessories for Through Terminal Blocks

Appropriate marking systems:
WMB/Marking strips

4-conductor through terminal block;
0.25 ... 2.5 (4) mm² / 22 ... 12 AWG
Terminal block width: 5.2 mm / 0.205 inch

gray	2002-1401	100
------	-----------	-----

4-conductor through terminal block; with push-button
0.25 ... 2.5 (4) mm² / 22 ... 12 AWG
Terminal block width: 5.2 mm / 0.205 inch

gray	2202-1401	100
------	-----------	-----

End and intermediate plate; 0.8 mm thick

orange	2002-1492	100 (25)
gray	2002-1491	100 (25)

Insulation stop; 5 pcs/strip; 0.25 ... 0.5 mm²

light gray	2002-171	200 (25)
------------	----------	----------

Insulation stop; 5 pcs/strip; 0.75 ... 1 mm²

dark gray	2002-172	200 (25)
-----------	----------	----------

Protective warning marker; with black high-voltage
symbol; for 5 terminal blocks

yellow	2002-115	100 (25)
--------	----------	----------

Push-in type wire jumper; insulated; 1.5 mm² conductor
cross-section; I_N 18 A

L = 60 mm	2009-412	100 (10)
L = 110 mm	2009-414	100 (10)
L = 250 mm	2009-416	100 (10)

Push-in type jumper bar; insulated; I_N 25 A; light gray

2-way	2002-402	25
3-way	2002-403	25
4-way	2002-404	25
5-way	2002-405	25
6-way	2002-406	25
7-way	2002-407	25
8-way	2002-408	25
9-way	2002-409	25
10-way	2002-410	25

Push-in type jumper bar; insulated; I_N 25 A; light gray

1 to 3	2002-433	25
1 to 4	2002-434	25
1 to 5	2002-435	25
1 to 6	2002-436	25
1 to 7	2002-437	25
1 to 8	2002-438	25
1 to 9	2002-439	25
1 to 10	2002-440	25



Lengths of through terminal blocks with a pluggable diode module:

- ① 48.5 mm / 1.91 inch for 2002-1201
- ② 59.2 mm / 2.33 inch for 2002-1301
- ③ 69.9 mm / 2.75 inch for 2002-1401

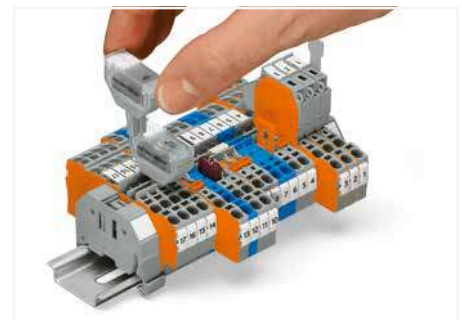

Similar to push-in type jumpers, these diode modules are simply pushed into the current bar's contact slots of two adjacent through terminal blocks, providing the following advantages:

- Compatible with all 2001 to 2006 Series Through Terminal Blocks equipped with jumper slots (note the module's width)
- Easy retrofits for existing systems
- Separation into functional and wiring levels
- Fast replacement of other functional units
- solder-free assembly of diodes, resistors, etc.



Opening the cover via operating tool (2.5 mm blade).

Pluggable LED Module TOPJOB® S on Carrier Terminal Block 2.5 (4) mm² 2002 Series

1

Technical Data
 U_N 250 V; U_{RM} 1000 V
 I_N ≤ 3 mA
 Plug width: 5.2 mm / 0.205 inch

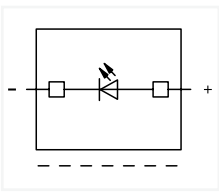

LED module; with red LED; max. operating temperature: 85°C; 5.2 mm wide

	Item No.	Pack. Unit
○ 12 ... 30 V	2002-800/1000-541	100
○ 30 ... 65 V	2002-800/1000-542	100
○ 230 V	2002-800/1000-836	100

Accessories for Carrier Terminal Blocks
 Appropriate marking systems:
 WMB/Marking strips

2-conductor carrier terminal block;
 0.25 ... 2.5 (4) mm² / 22 ... 12 AWG
 Terminal block width: 5.2 mm / 0.205 inch

gray	2002-1661	50
------	-----------	----

2-conductor carrier terminal block; with push-button
 0.25 ... 2.5 (4) mm² / 22 ... 12 AWG
 Terminal block width: 5.2 mm / 0.205 inch

gray	2202-1661	50
------	-----------	----

End and intermediate plate; 1 mm thick

orange	2002-1692	100 (25)
gray	2002-1691	100 (25)

3-conductor carrier terminal block;
 0.25 ... 2.5 (4) mm² / 22 ... 12 AWG
 Terminal block width: 5.2 mm / 0.205 inch

gray	2002-1761	50
------	-----------	----

3-conductor carrier terminal block; with push-button
 0.25 ... 2.5 (4) mm² / 22 ... 12 AWG
 Terminal block width: 5.2 mm / 0.205 inch

gray	2202-1761	50
------	-----------	----

End and intermediate plate; 1 mm thick

orange	2002-1792	100 (25)
gray	2002-1791	100 (25)

Please observe the application notes:
 Jumpers, from page 182
 Marking, from page 684

Approvals and corresponding ratings,
 visit www.wago.com

Accessories for Carrier Terminal Blocks
 Appropriate marking systems:
 WMB/Marking strips

4-conductor carrier terminal block;
 0.25 ... 2.5 (4) mm² / 22 ... 12 AWG
 Terminal block width: 5.2 mm / 0.205 inch

gray	2002-1861	50
------	-----------	----

4-conductor carrier terminal block; with push-button
 0.25 ... 2.5 (4) mm² / 22 ... 12 AWG
 Terminal block width: 5.2 mm / 0.205 inch

gray	2202-1861	50
------	-----------	----

End and intermediate plate; 1 mm thick

orange	2002-1892	100 (25)
gray	2002-1891	100 (25)

2-conductor carrier terminal block;
 0.25 ... 2.5 (4) mm² / 22 ... 12 AWG
 Terminal block width: 5.2 mm / 0.205 inch

gray	2002-1961	50
------	-----------	----

2-conductor carrier terminal block; with push-button
 0.25 ... 2.5 (4) mm² / 22 ... 12 AWG
 Terminal block width: 5.2 mm / 0.205 inch

gray	2202-1961	50
------	-----------	----

End and intermediate plate; 1 mm thick

orange	2002-1992	100 (25)
gray	2002-1991	100 (25)

Push-in type wire jumper; insulated; 1.5 mm² conductor
 cross-section; I_N 18 A

L = 60 mm	2009-412	100 (10)
L = 110 mm	2009-414	100 (10)
L = 250 mm	2009-416	100 (10)

Push-in type jumper bar; insulated; I_N 25 A; light gray

2-way	2002-402	25
3-way	2002-403	25
4-way	2002-404	25
5-way	2002-405	25
6-way	2002-406	25
7-way	2002-407	25
8-way	2002-408	25
9-way	2002-409	25
10-way	2002-410	25

Push-in type jumper bar; insulated; I_N 25 A; light gray

1 to 3	2002-433	25
1 to 4	2002-434	25
1 to 5	2002-435	25
1 to 6	2002-436	25
1 to 7	2002-437	25
1 to 8	2002-438	25
1 to 9	2002-439	25
1 to 10	2002-440	25



Lengths of carrier terminal blocks with a pluggable LED module:

- 1 66.1 mm / 2.62 inch for 2002-1661
- 2 76.8 mm / 3.02 inch for 2002-1761
- 3 87.5 mm / 3.45 inch for 2002-1861
- 4 72.9 mm / 2.87 inch for 2002-1961



The monitoring of control and operating current circuits with LED modules on rail-mount terminal blocks provides several advantages:

- No additional cost for assembly and wiring
- Separation into functional and wiring levels
- Modules can be replaced quickly by other types of modules
- Polarized switching direction
- Terminal blocks/modules provide high-density wiring in a width of just 5.2 mm

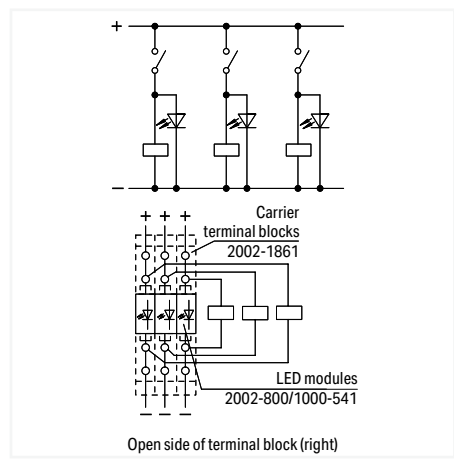

LED module (2002-800/1000-541)
 Voltage control assigned to current circuits

Pluggable LED Module TOPJOB® S on Through Terminal Block 2.5 (4) mm² 2002 Series

Technical Data

$I_N \leq 3 \text{ mA}$

Plug width: 10.4 mm / 0.409 inch

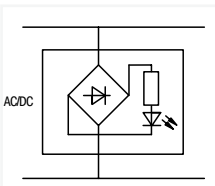

LED module; with red LED; max. operating temperature: 85°C; 10.4 mm wide

	Item No.	Pack. Unit
○ 12 ... 30 V	2002-880/1000-541	50
○ 30 ... 65 V	2002-880/1000-542	50
○ 230 V	2002-880/1000-836	50

Accessories for Through Terminal Blocks

Appropriate marking systems:
WMB/Marking strips

2-conductor through terminal block;
0.25 ... 2.5 (4) mm² / 22 ... 12 AWG
Terminal block width: 5.2 mm / 0.205 inch

gray	2002-1201	100
------	-----------	-----

2-conductor through terminal block; with push-button
0.25 ... 2.5 (4) mm² / 22 ... 12 AWG
Terminal block width: 5.2 mm / 0.205 inch

gray	2202-1201	100
------	-----------	-----

End and intermediate plate; 0.8 mm thick

orange	2002-1292	100 (25)
gray	2002-1291	100 (25)

3-conductor through terminal block;
0.25 ... 2.5 (4) mm² / 22 ... 12 AWG
Terminal block width: 5.2 mm / 0.205 inch

gray	2002-1301	100
------	-----------	-----

3-conductor through terminal block; with push-button
0.25 ... 2.5 (4) mm² / 22 ... 12 AWG
Terminal block width: 5.2 mm / 0.205 inch

gray	2202-1301	100
------	-----------	-----

End and intermediate plate; 0.8 mm thick

orange	2002-1392	100 (25)
gray	2002-1391	100 (25)

Please observe the application notes:
Marking, from page 684

Approvals and corresponding ratings,
visit www.wago.com

Accessories for Through Terminal Blocks

Appropriate marking systems:
WMB/Marking strips

4-conductor through terminal block;
0.25 ... 2.5 (4) mm² / 22 ... 12 AWG
Terminal block width: 5.2 mm / 0.205 inch

gray	2002-1401	100
------	-----------	-----

4-conductor through terminal block; with push-button
0.25 ... 2.5 (4) mm² / 22 ... 12 AWG
Terminal block width: 5.2 mm / 0.205 inch

gray	2202-1401	100
------	-----------	-----

End and intermediate plate; 0.8 mm thick

orange	2002-1492	100 (25)
gray	2002-1491	100 (25)



Dimensions of through terminal blocks with a pluggable LED module:

- ① 48.5 mm / 1.91 inch for 2002-1201
- ② 59.2 mm / 2.33 inch for 2002-1301
- ③ 69.9 mm / 2.75 inch for 2002-1401



Testing via 2-pole test plugs.



Labeling via WMB Multi markers and marking strips

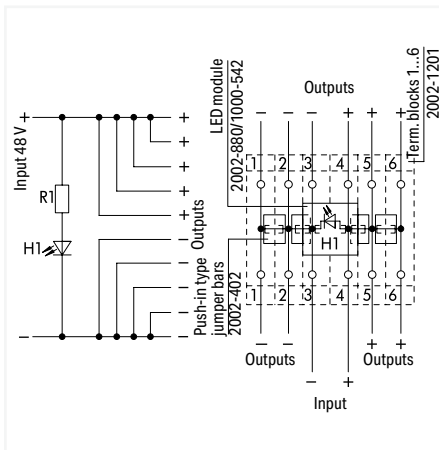

LED module (2002-880/1000-541)
Multiple outputs with indicator lamp

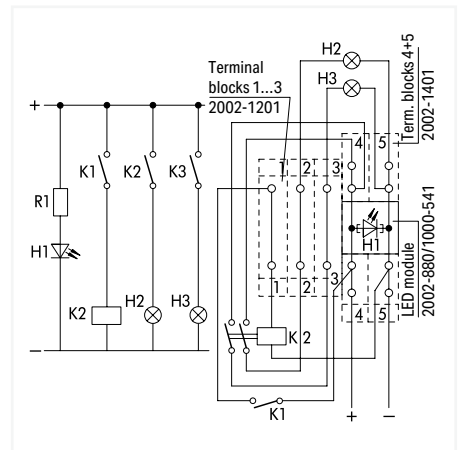

LED module (2002-880/1000-541)
Control unit

Empty Component Plug Housing TOPJOB® S on Carrier Terminal Block 2.5 (4) mm² 2002 Series

1

Technical Data

Plug width: 5.2 mm / 0.205 inch



Empty component plug housing; type 1; 2-pole; 5.2 mm wide

Color	Item No.	Pack. Unit
○ gray	2002-800	100

Technical Data

Plug width: 10.4 mm / 0.409 inch



Empty component plug housing; type 2; 2-pole; 10.4 mm wide

Color	Item No.	Pack. Unit
○ gray	2002-810	50

Empty component plug housing; type 3; 4-pole; 10.4 mm wide

○ gray	2002-820	50
--------	----------	----

Accessories for Carrier Terminal Blocks

Appropriate marking systems: WMB/Marking strips

2-conductor carrier terminal block;
0.25 ... 2.5 (4) mm² / 22 ... 12 AWG
Terminal block width: 5.2 mm / 0.205 inch

gray	2002-1661	50
------	-----------	----

4-conductor carrier terminal block;
0.25 ... 2.5 (4) mm² / 22 ... 12 AWG
Terminal block width: 5.2 mm / 0.205 inch

gray	2002-1861	50
------	-----------	----

2-conductor carrier terminal block; with push-button
0.25 ... 2.5 (4) mm² / 22 ... 12 AWG
Terminal block width: 5.2 mm / 0.205 inch

gray	2202-1661	50
------	-----------	----

4-conductor carrier terminal block; with push-button
0.25 ... 2.5 (4) mm² / 22 ... 12 AWG
Terminal block width: 5.2 mm / 0.205 inch

gray	2202-1861	50
------	-----------	----

**End and intermediate plate; 1 mm thick**

orange	2002-1692	100 (25)
gray	2002-1691	100 (25)

**End and intermediate plate; 1 mm thick**

orange	2002-1892	100 (25)
gray	2002-1891	100 (25)

3-conductor carrier terminal block;
0.25 ... 2.5 (4) mm² / 22 ... 12 AWG
Terminal block width: 5.2 mm / 0.205 inch

gray	2002-1761	50
------	-----------	----

2-conductor carrier terminal block;
0.25 ... 2.5 (4) mm² / 22 ... 12 AWG
Terminal block width: 5.2 mm / 0.205 inch

gray	2002-1961	50
------	-----------	----

3-conductor carrier terminal block; with push-button
0.25 ... 2.5 (4) mm² / 22 ... 12 AWG
Terminal block width: 5.2 mm / 0.205 inch

gray	2202-1761	50
------	-----------	----

2-conductor carrier terminal block; with push-button
0.25 ... 2.5 (4) mm² / 22 ... 12 AWG
Terminal block width: 5.2 mm / 0.205 inch

gray	2202-1961	50
------	-----------	----

**End and intermediate plate; 1 mm thick**

orange	2002-1792	100 (25)
gray	2002-1791	100 (25)

**End and intermediate plate; 1 mm thick**

orange	2002-1992	100 (25)
gray	2002-1991	100 (25)

Protective warning marker; with black high-voltage
symbol; for 5 terminal blocks

yellow	2002-115	100 (25)
--------	----------	----------



Multi-purpose operating tool; for component plugs

	2002-116	5
--	----------	---

Push-in type wire jumper; insulated; 1.5 mm² conductor
cross-section; I_N 18 A

L = 60 mm	2009-412	100 (10)
L = 110 mm	2009-414	100 (10)
L = 250 mm	2009-416	100 (10)

Please observe the application notes:
Jumpers, from page 182
Marking, from page 684Approvals and corresponding ratings,
visit www.wago.com**Accessories for Carrier Terminal Blocks**Appropriate marking systems:
WMB/WMB Inline/Marking stripsDouble-deck carrier terminal block;
0.25 ... 2.5 (4) mm² / 22 ... 12 AWG
Terminal block width: 5.2 mm / 0.205 inch

L/L	2002-2961	50
-----	-----------	----

Double-deck carrier terminal block;
0.25 ... 2.5 (4) mm² / 22 ... 12 AWG
Terminal block width: 5.2 mm / 0.205 inch

L/N	2002-2963	50
-----	-----------	----

**End and intermediate plate; 1 mm thick**

orange	2002-2992	100 (25)
gray	2002-2991	100 (25)

**Push-in type jumper bar; insulated; I_N 25 A; light gray**

2-way	2002-402	25
3-way	2002-403	25
4-way	2002-404	25
5-way	2002-405	25
6-way	2002-406	25
7-way	2002-407	25
8-way	2002-408	25
9-way	2002-409	25
10-way	2002-410	25

**Push-in type jumper bar; insulated; I_N 25 A; light gray**

1 to 3	2002-433	25
1 to 4	2002-434	25
1 to 5	2002-435	25
1 to 6	2002-436	25
1 to 7	2002-437	25
1 to 8	2002-438	25
1 to 9	2002-439	25
1 to 10	2002-440	25

**Staggered jumper; insulated; I_N 25 A; light gray**

2-way	2002-472	25
3-way	2002-473	25
4-way	2002-474	25
5-way	2002-475	25
6-way	2002-476	25
7-way	2002-477	25
8-way	2002-478	25
9-way	2002-479	25
10-way	2002-480	25
11-way	2002-481	25
12-way	2002-482	25

WMB marking card; white; 10 strips with 10 markers/card;
5 ... 5.2 mm stretchable

plain	793-5501	5
-------	----------	---





Lengths of carrier terminal blocks with a pluggable diode module:

- ❶ 66.1 mm / 2.62 inch for 2002-1661
- ❷ 76.8 mm / 3.02 inch for 2002-1761
- ❸ 87.5 mm / 3.45 inch for 2002-1861
- ❹ 72.9 mm / 2.87 inch for 2002-1961



Cutting component to the proper length.



Pressing component into plug contact via operating tool.

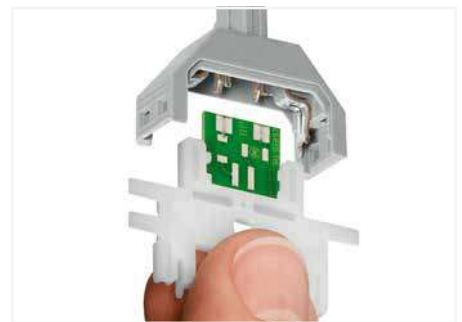

Pushing PCB into plug contact via operating tool.

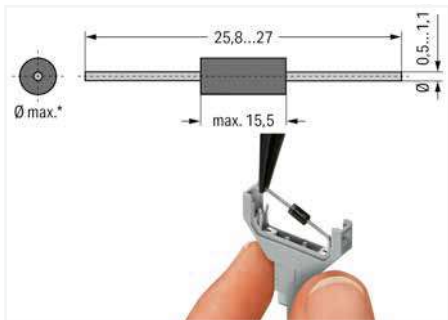

*max. 3.4 mm Ø at 5.2 mm module width and
 *max. 5.4 mm Ø at 10.4 mm module width
 Notice: Reconnection only possible with similar or larger wire diameter.



Component plugs for building custom circuits solder-free assembly of diodes, resistors, etc. (Illustration shows a 1N4007 diode)

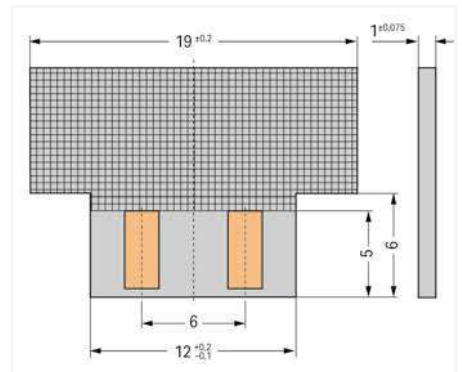

Dimensions of self-assembled PCBs:
 Module height: 2 mm at 5.2 mm module width and module height: 3.3 mm at 10.4 mm module width



When closing the cover, please insert cover as shown in the illustration.



Opening the cover via operating tool (2.5 mm blade).



Opening the cover via multi-purpose operating tool for component plugs.

Component Plug TOPJOB® S on Carrier Terminal Blocks 2.5 (4) mm² 2042 Series

1



Component plug; 4-pole; transparent housing; with fiber optics; 10.3 mm wide		
Item No.	Pack. Unit	
2042-321	5	

Component plug; 6-pole; transparent housing; with fiber optics; 15.5 mm wide		
Item No.	Pack. Unit	
2042-331	5	

Component plug; 8-pole; transparent housing; with fiber optics; 20.7 mm wide		
Item No.	Pack. Unit	
2042-341	5	

Component plug; 10-pole; transparent housing; with fiber optics; 25.9 mm wide		
Item No.	Pack. Unit	
2042-351	5	

Accessories for Carrier Terminal Blocks

Appropriate marking systems: WMB/Marking strips

2-conductor carrier terminal block; 0.25 ... 2.5 (4) mm ² / 22 ... 12 AWG Terminal block width: 5.2 mm / 0.205 inch			
	gray	2002-1661	50

4-conductor carrier terminal block; 0.25 ... 2.5 (4) mm ² / 22 ... 12 AWG Terminal block width: 5.2 mm / 0.205 inch			
	gray	2002-1861	50

2-conductor carrier terminal block; with push-button 0.25 ... 2.5 (4) mm ² / 22 ... 12 AWG Terminal block width: 5.2 mm / 0.205 inch			
	gray	2202-1661	50

4-conductor carrier terminal block; with push-button 0.25 ... 2.5 (4) mm ² / 22 ... 12 AWG Terminal block width: 5.2 mm / 0.205 inch			
	gray	2202-1861	50

End and intermediate plate; 1 mm thick			
	orange	2002-1692	100 (25)
	gray	2002-1691	100 (25)

End and intermediate plate; 1 mm thick			
	orange	2002-1892	100 (25)
	gray	2002-1891	100 (25)

3-conductor carrier terminal block; 0.25 ... 2.5 (4) mm ² / 22 ... 12 AWG Terminal block width: 5.2 mm / 0.205 inch			
	gray	2002-1761	50

2-conductor carrier terminal block; 0.25 ... 2.5 (4) mm ² / 22 ... 12 AWG Terminal block width: 5.2 mm / 0.205 inch			
	gray	2002-1961	50

3-conductor carrier terminal block; with push-button 0.25 ... 2.5 (4) mm ² / 22 ... 12 AWG Terminal block width: 5.2 mm / 0.205 inch			
	gray	2202-1761	50

2-conductor carrier terminal block; with push-button 0.25 ... 2.5 (4) mm ² / 22 ... 12 AWG Terminal block width: 5.2 mm / 0.205 inch			
	gray	2202-1961	50

End and intermediate plate; 1 mm thick			
	orange	2002-1792	100 (25)
	gray	2002-1791	100 (25)

End and intermediate plate; 1 mm thick			
	orange	2002-1992	100 (25)
	gray	2002-1991	100 (25)

Protective warning marker; with black high-voltage symbol; for 5 terminal blocks			
	yellow	2002-115	100 (25)

WMB marking card; white; 10 strips with 10 markers/card; 5 ... 5.2 mm stretchable			
	plain	793-5501	5

Push-in type wire jumper; insulated; 1.5 mm ² conductor cross-section; I _N 18 A			
	L = 60 mm	2009-412	100 (10)
	L = 110 mm	2009-414	100 (10)
	L = 250 mm	2009-416	100 (10)

Length for 2002-1661 – 66.5 mm / 2.62 inch	
2-conductor carrier terminal block	

Length for 2002-1761 – 76.8 mm / 3.02 inch	
3-conductor carrier terminal block	

Length for 2002-1861 – 87.5 mm / 3.45 inch	
4-conductor carrier terminal block	

Length for 2002-1961 – 72.9 mm / 2.87 inch	
2-conductor carrier terminal block; with additional jumper slot	

Please observe the application notes:
Jumpers, from page 182
Marking, from page 684

Approvals and corresponding ratings, visit www.wago.com

Accessories for Carrier Terminal Blocks

Appropriate marking systems:
WMB/WMB Inline/Marking strips

Double-deck carrier terminal block; 0.25 ... 2.5 (4) mm ² / 22 ... 12 AWG Terminal block width: 5.2 mm / 0.205 inch			
	L/L	2002-2961	50

Double-deck carrier terminal block; 0.25 ... 2.5 (4) mm ² / 22 ... 12 AWG Terminal block width: 5.2 mm / 0.205 inch			
	L/N	2002-2963	50

End and intermediate plate; 1 mm thick			
	orange	2002-2992	100 (25)
	gray	2002-2991	100 (25)

Push-in type jumper bar; insulated; I _N 25 A; light gray			
	2-way	2002-402	25
	3-way	2002-403	25
	4-way	2002-404	25
	5-way	2002-405	25
	6-way	2002-406	25
	7-way	2002-407	25
	8-way	2002-408	25
	9-way	2002-409	25
	10-way	2002-410	25

Push-in type jumper bar; insulated; I _N 25 A; light gray			
	1 to 3	2002-433	25
	1 to 4	2002-434	25
	1 to 5	2002-435	25
	1 to 6	2002-436	25
	1 to 7	2002-437	25
	1 to 8	2002-438	25
	1 to 9	2002-439	25
	1 to 10	2002-440	25

Staggered jumper; insulated; I _N 25 A; light gray			
	2-way	2002-472	25
	3-way	2002-473	25
	4-way	2002-474	25
	5-way	2002-475	25
	6-way	2002-476	25
	7-way	2002-477	25
	8-way	2002-478	25
	9-way	2002-479	25
	10-way	2002-480	25
	11-way	2002-481	25
	12-way	2002-482	25

Double-Deck Disconnect/Test Terminal Block TOPJOB® S

2.5 (4) mm²; 2002 Series

1

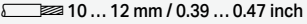
Technical Data	
0.25 ... 2.5 (4) mm ² ①	22 ... 12 AWG
400 V / 6 kV / 3 ②	300 V, 15 A ③
I _N 16 A	300 V, 15 A ④
Terminal block width: 5.2 mm / 0.205 inch	
 10 ... 12 mm / 0.39 ... 0.47 inch	

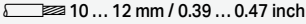
Technical Data	
0.25 ... 2.5 (4) mm ² ①	22 ... 12 AWG
400 V / 6 kV / 3 ②	300 V, 15 A ③
I _N 16 A	300 V, 15 A ④
Terminal block width: 5.2 mm / 0.205 inch	
 10 ... 12 mm / 0.39 ... 0.47 inch	

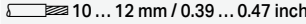
Technical Data	
0.25 ... 2.5 (4) mm ² ①	22 ... 12 AWG
400 V / 6 kV / 3 ②	300 V, 15 A ③
I _N 16 A	300 V, 15 A ④
Terminal block width: 5.2 mm / 0.205 inch	
 10 ... 12 mm / 0.39 ... 0.47 inch	

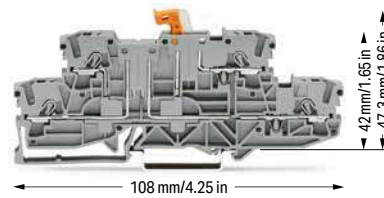
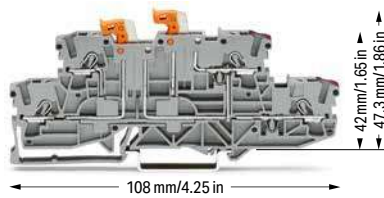
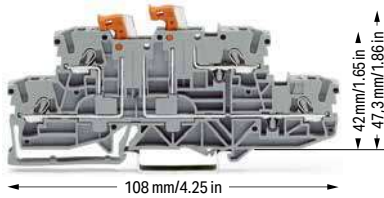

Double-deck, double-disconnect terminal block; with 2 pivoting knife disconnects; gray

Double-deck, double-disconnect terminal block; with two pivoting knife disconnects; lower and upper decks internally commoned on right side, violet conductor entry; gray

Double-deck disconnect terminal block; with pivoting knife disconnect; same profile as double-deck, double-disconnect terminal block; gray

	Item No.	Pack. Unit
○ L/L ⑤	2002-2951 ④	50
○ N/L ⑤	2002-2952 ④	50

	Item No.	Pack. Unit
○ L/L ⑤	2002-2958 ④	50

	Item No.	Pack. Unit
○ L/L ⑤	2002-2971 ④	50
○ N/L ⑤	2002-2972 ④	50

Double-deck, double-disconnect terminal block; with 2 pivoting knife disconnects; blue

Double-deck, double-disconnect terminal block; with two pivoting knife disconnects; lower and upper decks internally commoned on right side, violet conductor entry; blue

Double-deck disconnect terminal block; with pivoting knife disconnect; same profile as double-deck, double-disconnect terminal block; blue



● N/N ⑤	2002-2954 ③ ④	50
---------	---------------	----

● N/N ⑤	2002-2959 ③ ④	50
---------	---------------	----

● N/N ⑤	2002-2974 ③ ④	50
---------	---------------	----

Accessories; 2002 Series

Appropriate marking systems: WMB/WMB Inline/Marking strips









End and intermediate plate; 1 mm thick			
	orange	2002-2992	100 (25)
	gray	2002-2991	100 (25)









Ex e/Ex i separator; orange; 3 mm thick			
	125.5 mm	209-192	50 (25)

Insulation stop; 5 pcs/strip; 0.25 ... 0.5 mm ²			
	light gray	2002-171	200 (25)

Insulation stop; 5 pcs/strip; 0.75 ... 1 mm ²			
	dark gray	2002-172	200 (25)











Protective warning marker; with black high-voltage symbol; for 5 terminal blocks			
	yellow	2002-115	100 (25)



Push-in type jumper bar; insulated; I _N 25 A; light gray			
	2-way	2002-402	25
	3-way	2002-403	25
	4-way	2002-404	25
	5-way	2002-405	25
	6-way	2002-406	25
	7-way	2002-407	25
	8-way	2002-408	25
	9-way	2002-409	25
	10-way	2002-410	25

Push-in type jumper bar; insulated; I _N 25 A; light gray			
	1 to 3	2002-433	25
	1 to 4	2002-434	25
	1 to 5	2002-435	25
	1 to 6	2002-436	25
	1 to 7	2002-437	25
	1 to 8	2002-438	25
	1 to 9	2002-439	25
	1 to 10	2002-440	25



Delta jumper; insulated; I _N = I _N terminal block; light gray			
	1-2 3-4 5-6	2002-406/020-000	25

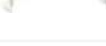

Star point jumper; insulated; I _N = I _N terminal block; light gray			
	1-3-5	2002-405/011-000	25

Staggered jumper; insulated; I _N 25 A; light gray			
	2-way	2002-472	25
	3-way	2002-473	25
	4-way	2002-474	25
	5-way	2002-475	25
	6-way	2002-476	25
	7-way	2002-477	25
	8-way	2002-478	25
	9-way	2002-479	25
	10-way	2002-480	25
	11-way	2002-481	25
	12-way	2002-482	25

Push-in type wire jumper; insulated; 1.5 mm ² conductor cross-section; I _N 18 A			
	L = 60 mm	2009-412	100 (10)
	L = 110 mm	2009-414	100 (10)
	L = 250 mm	2009-416	100 (10)

Continuous jumper; insulated; I _N 25 A, light gray			
	2-way	2002-400	25

Continuous jumper; insulated; I _N 25 A; light gray			
	1 to 3	2002-423	25
	1 to 4	2002-424	25

Continuous jumper; insulated; I _N 25 A, light gray			
	3-way	2002-413	25
	5-way	2002-415	25

Modular connector; snaps together; for jumper contact slot			
	gray	2002-511	100 (25)

Spacer module; snaps together; bridges commoned terminal blocks			
	gray	2002-549	100 (25)

Test plug adapter; for 4 mm Ø test plug			
	gray	2009-174	100 (25)

Testing tap; for max. 2.5 mm ²			
	gray	2009-182	100 (25)

Test plug; with 500 mm cable; 2 mm Ø; max. 42 V			
	red	210-136	50 (1)

- ❶ Conductor range: 0.25 ... 4 mm² "s+f-st";
Push-in termination: 1 ... 4 mm² "s" and 1 ... 2.5 mm² "insulated ferrules, 12 mm"
Depending on the conductor characteristic, a conductor with a smaller cross section can also be inserted via push-in termination.
- ❷ 400 V = rated voltage
6 kV = rated impulse voltage
3 = pollution degree
(see Section 15)
- ❸ Terminal blocks with a blue insulated housing are suitable for Ex i applications.
- ❹ Terminal blocks with an Ex mark are suitable for Ex e II applications.
440 V; 14 A
(see Section 15)

Please observe the application notes:
Jumpers, from page 182
Testing accessories, from page 177
Marking, from page 684

Approvals and corresponding ratings,
visit www.wago.com

Accessories; 2002 Series
Appropriate marking systems:
WMB/WMB Inline/Marking strips

Marking strip; plain; 11 mm wide; 50 m reel

	white	2009-110	1
--	-------	----------	---

WMB Inline, plain; 1,500 WMB markers (5 mm)/reel; 5 ... 5.2 mm stretchable

	white	2009-115	1
---	-------	----------	---

WMB marking card; white; 10 strips with 10 markers/card; 5 ... 5.2 mm stretchable

	plain	793-5501	5
---	-------	----------	---



Double-deck, double-disconnect terminal blocks (2002-2951) with group marker carrier accommodated in jumper contact slot



Double-deck, double-disconnect terminal block (2002-2951) with group marker carrier (2002-160) accommodated in jumper contact slot



Testing with voltage tester.

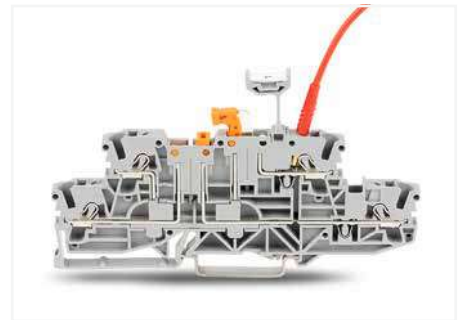

Double-deck, double-disconnect terminal block (2002-2951) with group marker carrier (2002-160) accommodated in a jumper contact slot and test plug (210-136)

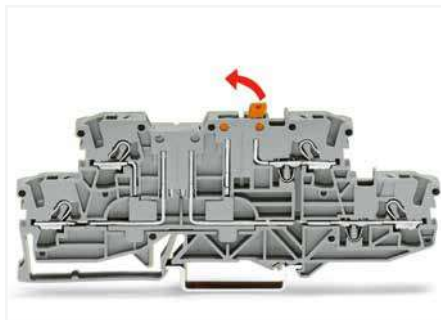

Double-deck disconnect terminal block (2002-2971)
Opening a knife disconnect.

Double-Deck Carrier Terminal Block TOPJOB® S

2.5 (4) mm²; 2002 Series

1

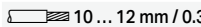
Technical Data	
0.25 ... 2.5 (4) mm ² ①	22 ... 12 AWG
400 V / 6 kV / 3 ②	300 V, 15 A ③
I _N 16 A	300 V, 15 A ④
Terminal block width: 5.2 mm / 0.205 inch	
 10 ... 12 mm / 0.39 ... 0.47 inch	

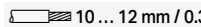
Technical Data	
0.25 ... 2.5 (4) mm ² ①	22 ... 12 AWG
400 V / 6 kV / 3 ②	300 V, 15 A ③
I _N 16 A	300 V, 15 A ④
Terminal block width: 5.2 mm / 0.205 inch	
 10 ... 12 mm / 0.39 ... 0.47 inch	

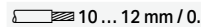
Technical Data	
0.25 ... 2.5 (4) mm ² ①	22 ... 12 AWG
400 V / 6 kV / 3 ②	300 V, 15 A ③
I _N 16 A	300 V, 15 A ④
Terminal block width: 5.2 mm / 0.205 inch	
 10 ... 12 mm / 0.39 ... 0.47 inch	

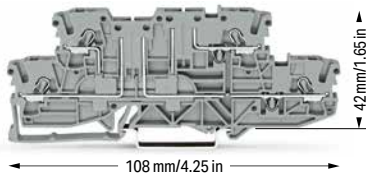

108 mm/4.25 in

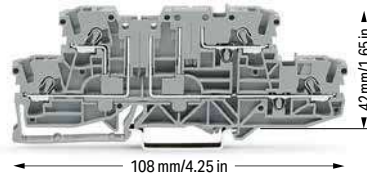

108 mm/4.25 in

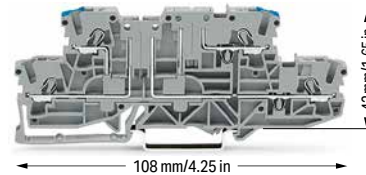

108 mm/4.25 in

Double-deck carrier terminal block; gray		
	Bestellnr.	VPE
○ L/L ⑤	2002-2941 ⑥	50

Double-deck carrier terminal block; gray		
	Bestellnr.	VPE
○ L/L ⑤	2002-2961 ⑥	50

Double-deck carrier terminal block; gray		
	Bestellnr.	VPE
○ L/N ⑤	2002-2963 ⑥	50

Accessories; 2002 Series

Appropriate marking systems: WMB/WMB Inline/Marking strips

End and intermediate plate; 1 mm thick			
	orange	2002-2992	100 (25)
	gray	2002-2991	100 (25)

Ex e/Ex i separator; orange; 3 mm thick			
	125.5 mm	209-192	50 (25)

Insulation stop; 5 pcs/strip; 0.25 ... 0.5 mm ²			
	light gray	2002-171	200 (25)

Insulation stop; 5 pcs/strip; 0.75 ... 1 mm ²			
	dark gray	2002-172	200 (25)

Protective warning marker; with black high-voltage symbol; for 5 terminal blocks			
	yellow	2002-115	100 (25)

Push-in type jumper bar; insulated; I _N 25 A; light gray			
	2-way	2002-402	25
	3-way	2002-403	25
	4-way	2002-404	25
	5-way	2002-405	25
	6-way	2002-406	25
	7-way	2002-407	25
	8-way	2002-408	25
	9-way	2002-409	25
	10-way	2002-410	25

Push-in type jumper bar; insulated; I _N 25 A; light gray			
	1 to 3	2002-433	25
	1 to 4	2002-434	25
	1 to 5	2002-435	25
	1 to 6	2002-436	25
	1 to 7	2002-437	25
	1 to 8	2002-438	25
	1 to 9	2002-439	25
	1 to 10	2002-440	25

Delta jumper; insulated; I _N = I _N terminal block; light gray			
	1-2 3-4 5-6	2002-406/020-000	25

Star point jumper; insulated; I _N = I _N terminal block; light gray			
	1-3-5	2002-405/011-000	25

Staggered jumper; insulated; I _N 25 A; light gray			
	2-way	2002-472	25
	3-way	2002-473	25
	4-way	2002-474	25
	5-way	2002-475	25
	6-way	2002-476	25
	7-way	2002-477	25
	8-way	2002-478	25
	9-way	2002-479	25
	10-way	2002-480	25
	11-way	2002-481	25
	12-way	2002-482	25

Continuous jumper; insulated; I _N 25 A; light gray			
	2-way	2002-400	25

Continuous jumper; insulated; I _N 25 A; light gray			
	1 to 3	2002-423	25
	1 to 4	2002-424	25

Continuous jumper; insulated; I _N 25 A; light gray			
	3-way	2002-413	25
	5-way	2002-415	25

Push-in type wire jumper; insulated; 1.5 mm ² conductor cross-section; I _N 18 A			
	L = 60 mm	2009-412	100 (10)
	L = 110 mm	2009-414	100 (10)
	L = 250 mm	2009-416	100 (10)

Disconnect plug for carrier terminal blocks; suitable when using a carrier terminal block as disconnect terminal block			
	orange	2002-401	100 (25)

Modular connector; snaps together; for jumper contact slot			
	gray	2002-511	100 (25)

Spacer module; snaps together; bridges commoned terminal blocks			
	gray	2002-549	100 (25)

Test plug adapter; for 4 mm Ø test plug			
	gray	2009-174	100 (25)

Testing tap; for max. 2.5 mm ²			
	gray	2009-182	100 (25)

Test plug; with 500 mm cable; 2 mm Ø; max. 42 V			
	red	210-136	50 (1)

Marking strip; plain; 11 mm wide; 50 m reel			
	white	2009-110	1

WMB Inline; plain; 1,500 WMB markers (5 mm)/reel; 5 ... 5.2 mm stretchable			
	white	2009-115	1

WMB marking card; white; 10 strips with 10 markers/card; 5 ... 5.2 mm stretchable			
	plain	793-5501	5

① Conductor range: 0.25 ... 4 mm² "s+f-st";
Push-in termination: 1 ... 4 mm² "s" and 1 ... 2.5 mm²
"insulated ferrules, 12 mm"
Depending on the conductor characteristic, a conductor with a smaller cross section can also be inserted via push-in termination.

② 400 V = rated voltage
6 kV = rated impulse voltage
3 = pollution degree
(see Section 15)

③ Terminal blocks with an Ex mark are suitable for Ex e II applications.
440 V; 14 A

Please observe the application notes:
Jumpers, from page 182
Testing accessories, from page 177
Marking, from page 684

Approvals and corresponding ratings,
visit www.wago.com



Carrier terminal block (2002-2941) with disconnect plug (2002-401) in parked position

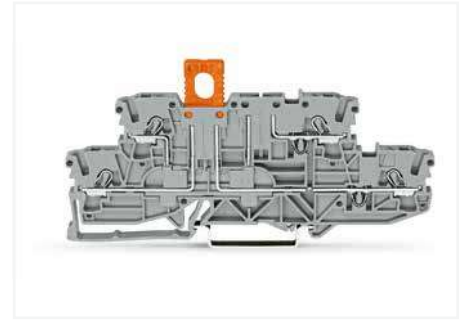



Carrier terminal block (2002-2941) with disconnect plug (2002-401) in operating position

Double-Deck Diode Terminal Block and LED Terminal Block TOPJOB® S

2.5 (4) mm²; 2002 Series

1

Technical Data	
0.25 ... 2.5 (4) mm ² ①	22 ... 12 AWG
U _N 250 V; U _{RM} 1000 V	
1N4007 - 0.5 A continuous current	
Terminal block width: 5.2 mm / 0.205 inch	
 10 ... 12 mm / 0.39 ... 0.47 inch	

Technical Data	
0.25 ... 2.5 (4) mm ² ①	22 ... 12 AWG
U _N 250 V; U _{RM} 1000 V	
1N4007 - 0.5 A continuous current	
Terminal block width: 5.2 mm / 0.205 inch	
 10 ... 12 mm / 0.39 ... 0.47 inch	

Technical Data	
0.25 ... 2.5 (4) mm ² ①	22 ... 12 AWG
24 VDC	
I _F 0.025 A max.	
Terminal block width: 5.2 mm / 0.205 inch	
 10 ... 12 mm / 0.39 ... 0.47 inch	

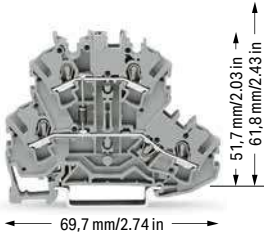

2002-2211/1000-410

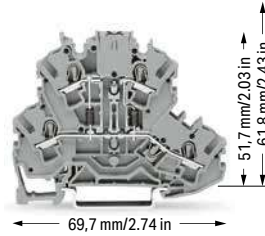

2002-2211/1000-411

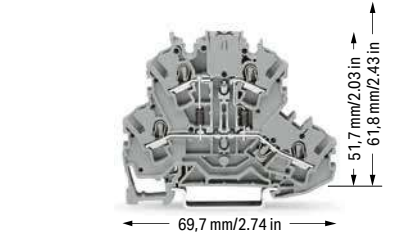

2002-2213/1000-487

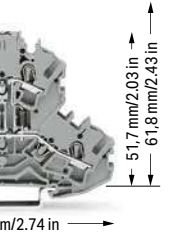

2002-2213/1000-488

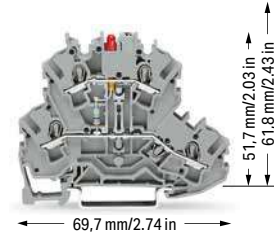

2002-2221/1000-434

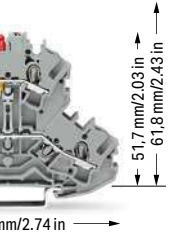

2002-2221/1000-413

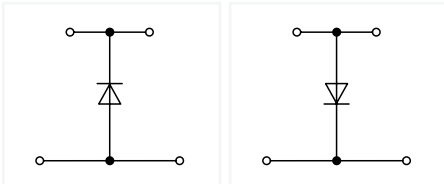

Double-deck diode terminal block; with 1N4007 diode; gray

	Item No.	Pack. Unit
○ anode bottom	2002-2211/1000-410	50
○ anode top	2002-2211/1000-411	50

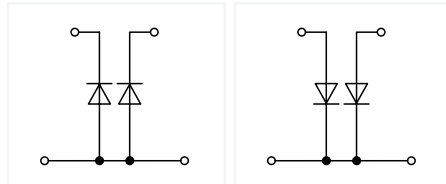

Double-deck diode terminal block; with two 1N4007 diodes; gray

	Item No.	Pack. Unit
○ anodes bottom	2002-2213/1000-487	50
○ anodes top	2002-2213/1000-488	50

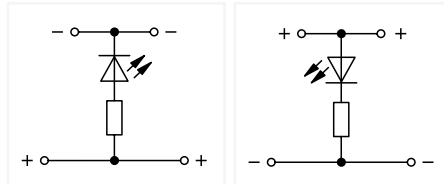

Double-deck LED terminal block; with red LED; gray

	Item No.	Pack. Unit
○ anode bottom	2002-2221/1000-434	50
○ anode top	2002-2221/1000-413	50

Other terminal blocks with the same profile:
Through [2002-2201](#) Page 76

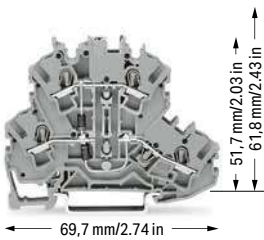

2002-2214/1000-492

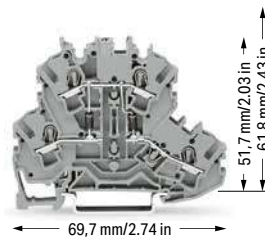

2002-2214/1000-491

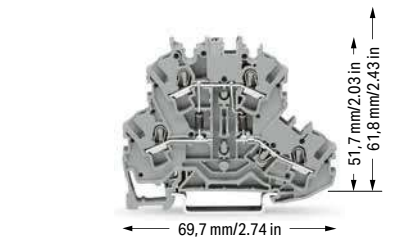

2002-2214/1000-489

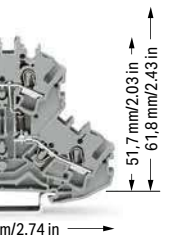

2002-2214/1000-490

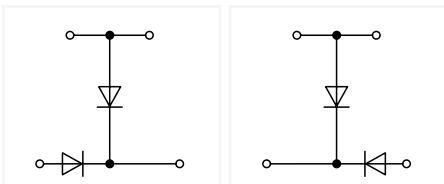

Double-deck diode terminal block; with two 1N4007 diodes; gray

	Item No.	Pack. Unit
○ anode top, anode left	2002-2214/1000-492	50
○ anode top, anode right	2002-2214/1000-491	50

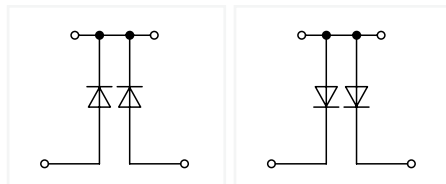

Double-deck diode terminal block; with two 1N4007 diodes; gray

	Item No.	Pack. Unit
○ anodes bottom	2002-2214/1000-489	50
○ anodes top	2002-2214/1000-490	50



Double-Deck Diode Terminal Blocks and LED Terminal Blocks TOPJOB® S Circuit Configuration Examples

❶ Conductor range: 0.25 ... 4 mm² "s+f-st";
Push-in termination: 1 ... 4 mm² "s" and 1 ... 2.5 mm²
"insulated ferrules, 12 mm"
Depending on the conductor characteristic, a conductor with a smaller cross section can also be inserted via push-in termination.

Approvals and corresponding ratings, visit www.wago.com

Accessories; 2002 Series
Appropriate marking systems:
WMB/WMB Inline/Marking strips

End and intermediate plate; 0.8 mm thick

	orange	2002-2292	100 (25)
	gray	2002-2291	100 (25)

Insulation stop; 5 pcs/strip; 0.25 ... 0.5 mm²

	light gray	2002-171	200 (25)
---	------------	----------	----------

Insulation stop; 5 pcs/strip; 0.75 ... 1 mm²

	dark gray	2002-172	200 (25)
---	-----------	----------	----------

Push-in type jumper bar; insulated; I_N 25 A; light gray

	2-way	2002-402	25
	3-way	2002-403	25
	4-way	2002-404	25
	5-way	2002-405	25
	6-way	2002-406	25
	7-way	2002-407	25
	8-way	2002-408	25
	9-way	2002-409	25
	10-way	2002-410	25

Push-in type jumper bar; insulated; I_N 25 A; light gray

	1 to 3	2002-433	25
	1 to 4	2002-434	25
	1 to 5	2002-435	25
	1 to 6	2002-436	25
	1 to 7	2002-437	25
	1 to 8	2002-438	25
	1 to 9	2002-439	25
	1 to 10	2002-440	25

Double-deck marker carrier; pivoting

	gray	2002-121	50 (25)
---	------	----------	---------

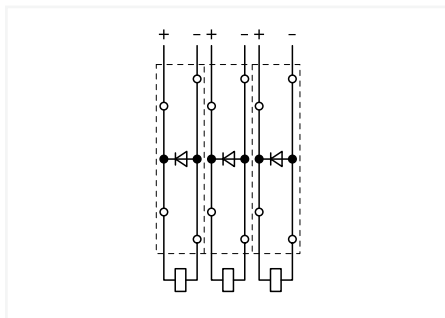

Open diode gates can be created using the following terminal blocks:
2002-2211/1000-410 or 2002-2211/1000-411



Double-deck diode terminal blocks were specifically developed for custom diode circuits, such as lamp test and collective fault signal circuits. These terminal blocks provide high-density wiring in a width of just 5.2 mm. Push-in type jumper bars provide additional options for custom circuit design.

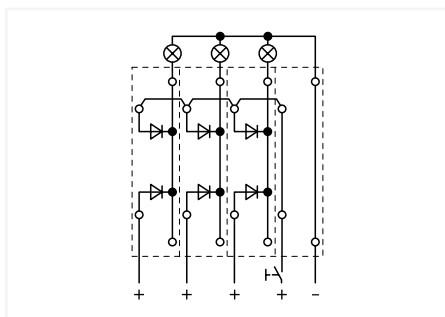

Polarized diode gates with a common cathode can be created using the following terminal blocks:
2002-2213/1000-487 or 2002-2213/1000-488

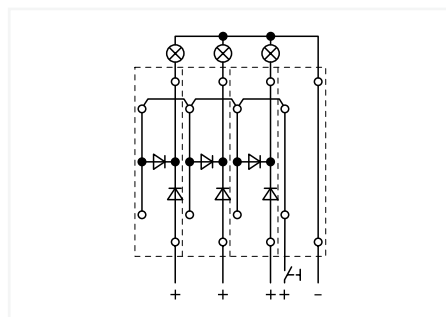

Lamp test circuits can be created using the following terminal blocks:
2002-2214/1000-492 or 2002-2214/1000-491

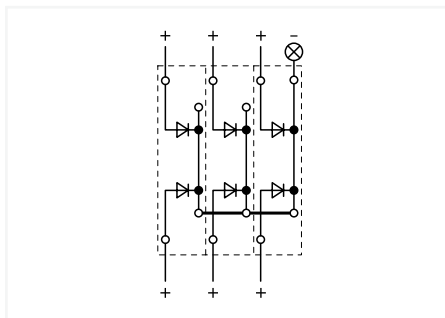

Polarized diode gates with a common cathode can be created using the following terminal blocks:
2002-2214/1000-489 or 2002-2214/1000-490

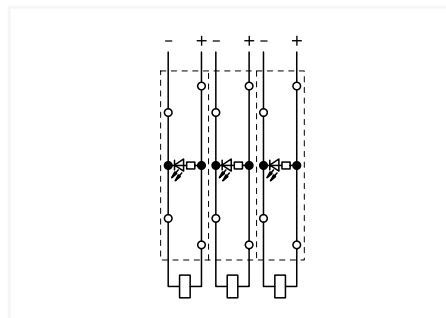

Circuit-related voltage indications can be created using the following terminal blocks:
2002-2221/1000-434 or 2002-2221/1000-413

Triple-Deck Diode Terminal Block, Triple-Deck LED Terminal Block TOPJOB® S

2.5 (4) mm²; 2002 Series

1

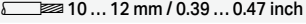
Technical Data	
0.25 ... 2.5 (4) mm ² ①	22 ... 12 AWG
U _N 250 V; U _{RM} 1000 V	
1N4007 - 0.5 A continuous current	
Terminal block width: 5.2 mm / 0.205 inch	
 10 ... 12 mm / 0.39 ... 0.47 inch	

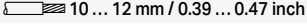
Technical Data	
0.25 ... 2.5 (4) mm ² ①	22 ... 12 AWG
U _N 250 V; U _{RM} 1000 V	
1N4007 - 0.5 A continuous current	
Terminal block width: 5.2 mm / 0.205 inch	
 10 ... 12 mm / 0.39 ... 0.47 inch	

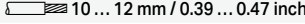
Technical Data	
0.25 ... 2.5 (4) mm ² ①	22 ... 12 AWG
24 VDC	
I _F 0.025 A max.	
Terminal block width: 5.2 mm / 0.205 inch	
 10 ... 12 mm / 0.39 ... 0.47 inch	

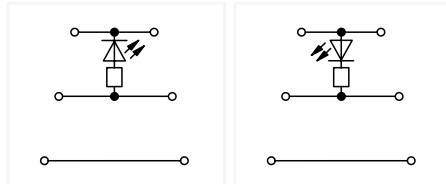
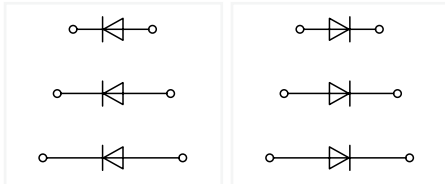
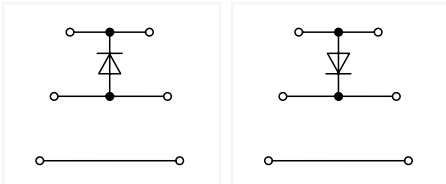
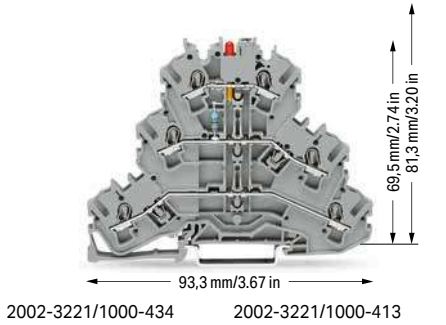
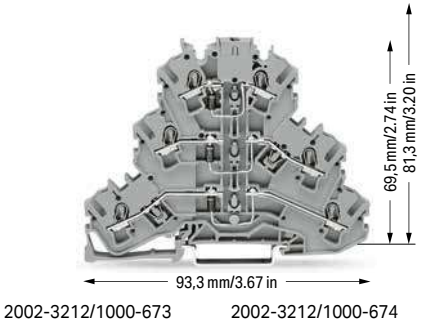
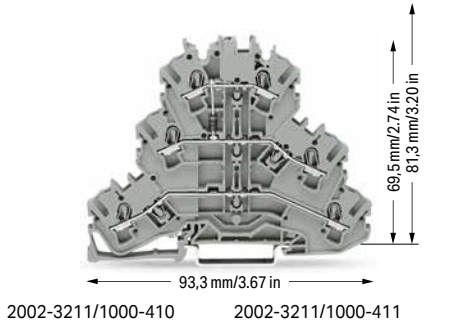

Triple-deck diode terminal block, with 1N4007 diode; gray

	Item No.	Pack. Unit
○ anode bottom	2002-3211/1000-410	50
○ anode top	2002-3211/1000-411	50

Triple-deck diode terminal block; with three 1N4007 diodes; gray

	Item No.	Pack. Unit
○ anodes right	2002-3212/1000-673	50
○ anodes left	2002-3212/1000-674	50

Triple-deck LED terminal block; with red LED; gray

	Item No.	Pack. Unit
○ anode bottom	2002-3221/1000-434	50
○ anode top	2002-3221/1000-413	50

Other terminal blocks with the same profile:
Through **2002-3201** Page 88

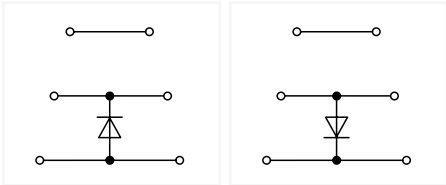
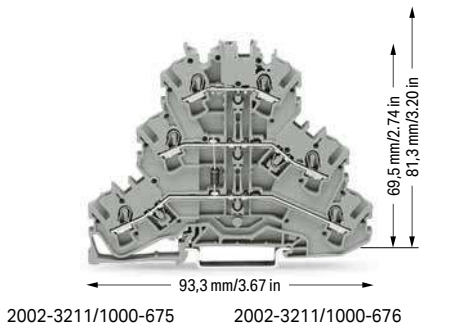

Triple-deck diode terminal block, with 1N4007 diode; gray

	Item No.	Pack. Unit
○ anode bottom	2002-3211/1000-675	50
○ anode top	2002-3211/1000-676	50

① Conductor range: 0.25 ... 4 mm² "s+f-st";
Push-in termination: 1 ... 4 mm² "s" and 1 ... 2.5 mm²
"insulated ferrules, 12 mm"
Depending on the conductor characteristic, a conductor
with a smaller cross section can also be inserted
via push-in termination.

Approvals and corresponding ratings,
visit www.wago.com

Accessories; 2002 Series
Appropriate marking systems:
WMB/WMB Inline/Marking strips

End and intermediate plate; 0.8 mm thick

	orange	2002-3292	100 (25)
	gray	2002-3291	100 (25)

Insulation stop; 5 pcs/strip; 0.25 ... 0.5 mm²

	light gray	2002-171	200 (25)
---	------------	----------	----------

Insulation stop; 5 pcs/strip; 0.75 ... 1 mm²

	dark gray	2002-172	200 (25)
---	-----------	----------	----------

Push-in type jumper bar; insulated; I_N 25 A; light gray

	2-way	2002-402	25
	3-way	2002-403	25
	4-way	2002-404	25
	5-way	2002-405	25
	6-way	2002-406	25
	7-way	2002-407	25
	8-way	2002-408	25
	9-way	2002-409	25
	10-way	2002-410	25

Push-in type jumper bar; insulated; I_N 25 A; light gray

	1 to 3	2002-433	25
	1 to 4	2002-434	25
	1 to 5	2002-435	25
	1 to 6	2002-436	25
	1 to 7	2002-437	25
	1 to 8	2002-438	25
	1 to 9	2002-439	25
	1 to 10	2002-440	25

Modular connector; snaps together; for jumper contact slot

	gray	2002-511	100 (25)
---	------	----------	----------

Spacer module; snaps together; bridges commoned terminal blocks

	gray	2002-549	100 (25)
---	------	----------	----------

Test plug adapter; for 4 mm Ø test plug

	gray	2009-174	100 (25)
---	------	----------	----------

Testing tap; for max. 2.5 mm²

	gray	2009-182	100 (25)
---	------	----------	----------

Accessories; 2002 Series
Appropriate marking systems:
WMB/WMB Inline/Marking strips

Marking strip; plain; 11 mm wide; 50 m reel

	white	2009-110	1
---	-------	----------	---

WMB Inline, plain; 1,500 WMB markers (5 mm)/reel; 5 ... 5.2 mm stretchable

	white	2009-115	1
---	-------	----------	---

WMB marking card; white; 10 strips with 10 markers/card; 5 ... 5.2 mm stretchable

	plain	793-5501	5
---	-------	----------	---

Triple-deck marker carrier; pivoting

	gray	2002-131	50 (25)
---	------	----------	---------



Double- and triple-deck LED terminal blocks:
Using LED terminal blocks, monitoring units can be
designed, e.g., for control and operating circuits.



Triple-deck diode terminal blocks were specifically devel-
oped for custom diode circuits, such as lamp test and col-
lective fault signal circuits.
These terminal blocks provide high-density wiring in a
width of just 5.2 mm.
Push-in type jumper bars provide additional options for
custom circuit design.

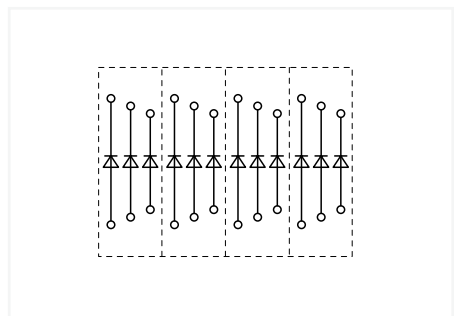

Open diode gates can be created and connected individu-
ally using the following terminal blocks:
2002-3212/1000-673 or 2002-3212/1000-674

Using push-in type jumper bars, individual decks can be
turned into polarized diode gates.

Connector, Connector Strip TOPJOB® S

1 (1.5) mm²; 2000 Series and 1.5 (2,5) mm²; 2001 Series and 2.5 (4) mm²; 2002 Series

Technical Data

0.14 ... 1 (1.5) mm ² ①	24 ... 16 AWG
500 V / 6 kV / 3 ④	300 V, 10 A 
I _N 13.5 A	300 V, 10 A 

Terminal block width: 3.5 mm / 0.138 inch

 9 ... 11 mm / 0.35 ... 0.43 inch

Technical Data

0.14 ... 1 (1.5) mm ² ①	24 ... 16 AWG
500 V / 6 kV / 3 ④	600 V, 10 A 
I _N 13.5 A	300 V, 10 A 

Terminal block width: 5 mm / 0.197 inch

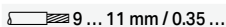
 9 ... 11 mm / 0.35 ... 0.43 inch

Technical Data

0.25 ... 1.5 (2.5) mm ² ②	22 ... 14 AWG
500 V / 6 kV / 3 ④	300 V, 15 A 
I _N 17.5 A	300 V, 15 A 

Terminal block width: 4.2 mm / 0.165 inch

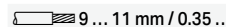
 9 ... 11 mm / 0.35 ... 0.43 inch

Modular connector; for jumper contact slot; snaps together; gray

	Item No.	Pack. Unit
<input type="radio"/> 1-pole	2000-510	100 (25)

Modular connector; with end plate; for jumper contact slot; snaps together; gray

	Item No.	Pack. Unit
<input type="radio"/> 1-pole	2000-511	100 (25)

Modular connector; for jumper contact slot; snaps together; gray

	Item No.	Pack. Unit
<input type="radio"/> 1-pole	2001-511	100 (25)

Spacer module; snaps together; bridges commoned terminal blocks

<input type="radio"/> gray	2000-549	100 (25)
----------------------------	----------	----------

Spacer module; snaps together; bridges commoned terminal blocks

<input type="radio"/> gray	2001-549	100 (25)
----------------------------	----------	----------

connector strip; for jumper contact slot; gray

<input type="radio"/> 2-pole	2000-552	25
<input type="radio"/> 3-pole	2000-553	25
<input type="radio"/> 4-pole	2000-554	25
<input type="radio"/> 5-pole	2000-555	10
<input type="radio"/> 6-pole	2000-556	10
<input type="radio"/> 7-pole	2000-557	10
<input type="radio"/> 8-pole	2000-558	10
<input type="radio"/> 9-pole	2000-559	10
<input type="radio"/> 10-pole	2000-560	10

connector strip; for jumper contact slot; gray

<input type="radio"/> 2-pole	2001-552	25
<input type="radio"/> 3-pole	2001-553	25
<input type="radio"/> 4-pole	2001-554	25
<input type="radio"/> 5-pole	2001-555	10
<input type="radio"/> 6-pole	2001-556	10
<input type="radio"/> 7-pole	2001-557	10
<input type="radio"/> 8-pole	2001-558	10
<input type="radio"/> 9-pole	2001-559	10
<input type="radio"/> 10-pole	2001-560	10

Accessories; item-specific

WMB Inline; plain; 2,300 WMB markers (3.5 mm)/reel

	white	2009-113	1
---	-------	----------	---

Accessories; item-specific

WMB Inline; plain; 1,500 WMB markers (5 mm)/reel; 5 ... 5.2 mm stretchable

	white	2009-115	1
---	-------	----------	---

Accessories; item-specific

WMB Inline; plain; 2,000 WMB markers (4 mm)/reel; 4 ... 4.2 mm stretchable

	white	2009-114	1
---	-------	----------	---

WMB marking card; white; 10 strips with 10 markers/card; for 3.5 mm terminal block width

	plain	793-3501	5
--	-------	----------	---

WMB marking card; white; 10 strips with 10 markers/card; 5 ... 5.2 mm stretchable

	plain	793-5501	5
---	-------	----------	---

WMB marking card; white; 10 strips with 10 markers/card; 4 ... 4.2 mm stretchable

	plain	793-4501	5
---	-------	----------	---

Accessories; 2000 Series

Appropriate marking systems: WMB/WMB Inline/Marking strips

End plate; for modular connector; 1.5 mm thick

	gray	2002-541	100 (25)
---	------	----------	----------

Test plug; with 500 mm cable; 2 mm Ø; max. 42 V

	red	210-136	50 (1)
---	-----	---------	--------

Strain relief plate; gray

	35 mm wide	734-326	100 (25)
	6 mm wide	734-327	100 (25)
	12.5 mm wide	734-328	100 (25)
	25 mm wide	734-329	100 (25)

PUSH-IN CAGE CLAMP®

1

Technical Data

0.25 ... 2.5 (4) mm ² ③	22 ... 12 AWG
500 V / 6 kV / 3 ④	300 V, 20 A ①
I _n 24 A	300 V, 20 A ②
Terminal block width: 5.2 mm / 0.205 inch	
10 ... 12 mm / 0.39 ... 0.47 inch	



Modular connector; for jumper contact slot; snaps together; gray

	Item No.	Pack. Unit
○ 1-pole	2002-511	100 (25)

Spacer module; snaps together; bridges commoned terminal blocks

○ gray	2002-549	100 (25)
--------	----------	----------

connector strip; for jumper contact slot; gray

○ 2-pole	2002-552	25
○ 3-pole	2002-553	25
○ 4-pole	2002-554	25
○ 5-pole	2002-555	10
○ 6-pole	2002-556	10
○ 7-pole	2002-557	10
○ 8-pole	2002-558	10
○ 9-pole	2002-559	10
○ 10-pole	2002-560	10

Accessories; item-specific

WMB Inline, plain; 1,500 WMB markers (5 mm)/reel; 5 ... 5.2 mm stretchable

	white	2009-115	1
--	-------	----------	---

WMB marking card; white; 10 strips with 10 markers/card; 5 ... 5.2 mm stretchable

	plain	793-5501	5
--	-------	----------	---

Marking strip; plain; 11 mm wide; 50 m reel

	white	2009-110	1
--	-------	----------	---

① Conductor range: 0.14 ... 1.5 mm² "s+f-st"; Push-in termination: 0.5 ... 1.5 mm² "s" and 0.5 ... 0.75 mm² "insulated ferrules; 10 mm" Depending on the conductor characteristic, a conductor with a smaller cross section can also be inserted via push-in termination.

② Conductor range: 0.25 ... 2.5 mm² "s+f-st"; Push-in termination: 0.75 ... 2.5 mm² "s" and 0.75 ... 1.5 mm² "insulated ferrules; 12 mm" Depending on the conductor characteristic, a conductor with a smaller cross section can also be inserted via push-in termination.

③ Conductor range: 0.25 ... 4 mm² "s+f-st"; Push-in termination: 1 ... 4 mm² "s" and 1 ... 2.5 mm² "insulated ferrules; 12 mm" Depending on the conductor characteristic, a conductor with a smaller cross section can also be inserted via push-in termination.

④ 500 V = rated voltage
6 kV = rated impulse voltage
3 = pollution degree (see Section 15)

Note:

According to EN 61984, pluggable connectors without a current interrupting capacity must not be mated or unmated when live or under load.

Approvals and corresponding ratings, visit www.wago.com

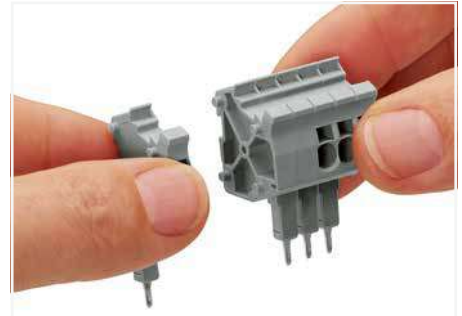

Snapping connectors and spacers together to assemble a multipole connector.

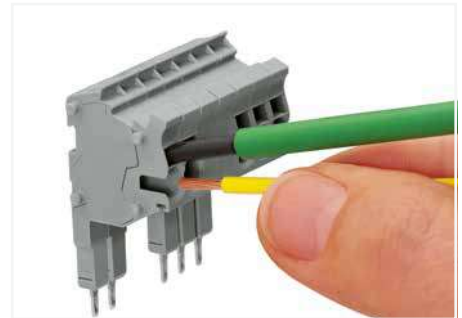

Operating tool for fine-stranded conductors without ferrules – push-in connection of solid conductors



Rail-mount terminal block assembly for electric motor wiring



Snapping on a strain relief plate.



The modular connectors also connect conductors of the same size as the terminal blocks being used.



Connectors with a 2 mm Ø test socket for testing voltage via 2-pole voltage tester

Connector, Connector Strip TOPJOB® S

4 (6) mm²; 2004 Series; 2006 Series; 2010 Series and 2016 Series

1

Technical Data

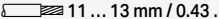
0.5 ... 4 (6) mm ² ①	22 ... 10 AWG
500 V / 6 kV / 3 ②	300 V, 30 A ③
I _N 32 A	300 V, 30 A ④
Terminal block width: 6.2 mm / 0.244 inch	
 11 ... 13 mm / 0.43 ... 0.51 inch	



Technical Data

0.5 ... 4 (6) mm ² ①	22 ... 10 AWG
500 V / 6 kV / 3 ②	I _N 32 A
Terminal block width: 7.5 mm / 0.295 inch	
 11 ... 13 mm / 0.43 ... 0.51 inch	

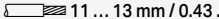

Technical Data

0.5 ... 4 (6) mm ² ①	22 ... 10 AWG
500 V / 6 kV / 3 ②	I _N 32 A
Terminal block width: 10 mm / 0.394 inch	
 11 ... 13 mm / 0.43 ... 0.51 inch	



Modular connector; for jumper contact slot; snaps together; gray

	Item No.	Pack. Unit
<input type="radio"/> 1-pole	2004-511	100 (25)

Modular connector; for jumper contact slot; snaps together; gray

	Item No.	Pack. Unit
<input type="radio"/> 1-pole	2006-511	50 (25)

Modular connector; for jumper contact slot; snaps together; gray

	Item No.	Pack. Unit
<input type="radio"/> 1-pole	2010-511	50 (25)

Spacer module; snaps together; bridges commoned terminal blocks

<input type="radio"/> gray	2004-549	100 (25)
----------------------------	----------	----------

Spacer module; snaps together; bridges commoned terminal blocks

<input type="radio"/> gray	2006-549	50 (25)
----------------------------	----------	---------

Spacer module; snaps together; bridges commoned terminal blocks

<input type="radio"/> gray	2010-549	50 (25)
----------------------------	----------	---------

connector strip; for jumper contact slot; gray

<input type="radio"/> 2-pole	2004-552	25
<input type="radio"/> 3-pole	2004-553	25
<input type="radio"/> 4-pole	2004-554	25
<input type="radio"/> 5-pole	2004-555	10

Accessories, for connector strips

Appropriate marking systems: WMB/WMB Inline/Marking strips

End plate; for modular connector; 1.5 mm thick

gray	2004-541	100 (25)
------	----------	----------



Test plug; with 500 mm cable; 2 mm Ø; max. 42 V

red	210-136	50 (1)
-----	---------	--------



Strain relief plate; gray

35 mm wide	734-326	100 (25)
6 mm wide	734-327	100 (25)
12.5 mm wide	734-328	100 (25)
25 mm wide	734-329	100 (25)



Marking strip; plain; 11 mm wide; 50 m reel

white	2009-110	1
-------	----------	---



WMB marking card; white; 10 strips with 10 markers/card; 5 ... 5.2 mm stretchable

plain	793-5501	5
-------	----------	---



Technical Data

0.5 ... 4 (6) mm² ① | 22 ... 10 AWG

500 V / 6 kV / 3 ②

I_N 32 A

Terminal block width: 12 mm / 0.472 inch

 11 ... 13 mm / 0.43 ... 0.51 inch

① Conductor range: 0.5 ... 6 mm² "s+f-st";
Push-in termination: 1.5 ... 6 mm² "s" and 1.5 ... 4 mm²
"insulated ferrules; 12 mm"
Depending on the conductor characteristic, a conductor with a smaller cross section can also be inserted via push-in termination.

② 500 V = rated voltage
6 kV = rated impulse voltage
3 = pollution degree
(see Section 15)

Note:

According to EN 61984, pluggable connectors without a current interrupting capacity must not be mated or unmated when live or under load.

Approvals and corresponding ratings, visit www.wago.com

Modular connector; for jumper contact slot; snaps together; gray

	Item No.	Pack. Unit
<input type="radio"/> 1-pole	2016-511	50 (25)

Spacer module; snaps together; bridges commoned terminal blocks

<input type="radio"/> gray	2016-549	50 (25)
----------------------------	----------	---------

PUSH-IN CAGE CLAMP®

L-Type Test Plug Module TOPJOB® S for Testing 5.2 mm Wide Rail-Mount Terminal Blocks – via Conductor Entries

2.5 (4) mm²; 2002 Series

1

Technical Data

0.25 ... 2.5 (4) mm² ① | 22 ... 12 AWG
 500 V / 6 kV / 3 ②
 I_N 18 A
 Terminal block width: 5.2 mm / 0.205 inch
 10 ... 12 mm / 0.39 ... 0.47 inch



- ① Conductor range: 0.25 ... 4 mm² "s+f-st"; Push-in termination: 1 ... 4 mm² "s" and 1 ... 2.5 mm² "insulated ferrules, 12 mm"
 Depending on the conductor characteristic, a conductor with a smaller cross section can also be inserted via push-in termination.
 - ② 500 V = rated voltage
 6 kV = rated impulse voltage
 3 = pollution degree (see Section 15)
- Approvals and corresponding ratings, visit www.wago.com



L-type test plug assembly:
 L-type test plug modules and L-type spacer modules (max. 10-pole)
 Additionally, terminal blocks can be skipped using spacer modules.

L-type test plug module; snaps together; gray
 According to EN 61984, pluggable connectors without a current interrupting capacity must not be mated or unmated when live or under load.

	Item No.	Pack. Unit
○ 1-pole	2002-611	100 (25)

Spacer module; snaps together; bridges commoned terminal blocks

○ gray	2002-649	100 (25)
--------	----------	----------

Accessories; for L-type test plug modules

Appropriate marking systems:
 WMB/WMB Inline/Mini-WSB

End plate; for modular test plug module; 1.5 mm thick

 gray	2002-641	100 (25)
--	----------	----------

Test plug; with 500 mm cable; 2 mm Ø; max. 42 V

 red	210-136	50 (1)
---	---------	--------

Strain relief plate; gray

 35 mm wide	734-326	100 (25)
6 mm wide	734-327	100 (25)
12.5 mm wide	734-328	100 (25)
25 mm wide	734-329	100 (25)

WMB Inline, plain; 1,500 WMB markers (5 mm)/reel; 5 ... 5.2 mm stretchable

 white	2009-115	1
---	----------	---

WMB marking card; white; 10 strips with 10 markers/card; 5 ... 5.2 mm stretchable

 plain	793-5501	5
--	----------	---



L-type test plug modules fitted in a triple-deck terminal block



L-type test plug modules for testing rail-mount terminal blocks via conductor entries

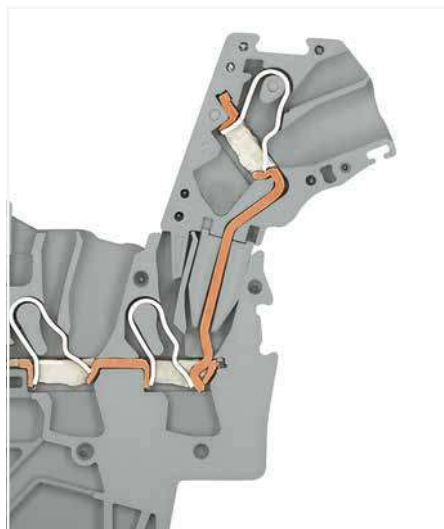

L-type test plug module – cross-sectional view of contacts

Test Plug Adapter, Testing Tap TOPJOB® S 2009 Series



Test plug adapter; for 4 mm Ø test plug; for testing Rail-Mount Terminal Blocks TOPJOB® S
Power must be switched off when installing the test plug adapter. The safety guidelines for working on live installations must be observed.

Color	Item No.	Pack. Unit
○ gray	2009-174	100 (25)

Testing tap; for max. 2.5 mm²; connects test cables (0.08 ... 2.5 mm²) without tool
Power must be switched off when installing the testing tap. The safety guidelines for working on live installations must be observed.

Color	Item No.	Pack. Unit
○ gray	2009-182	100 (25)

Item-Specific Accessories

Banana plug; for 4 mm socket diameter; color mixed; 10 x orange, white, black, blue, yellow; max. 42 V



215-111 50



Test plug adapter (2009-174, CAT I) for 4 mm Ø plugs – compatible with 2000 to 2016 Series



Testing tap (2009-182) for tool-free connection of test cables up to 2.5 mm² (12 AWG) – compatible with 2000 to 2016 Series

Colored Push-In Type Jumper Bar TOPJOB® S 2000 Series and 2002 Series

1



Push-in type jumper bar; insulated; I_N 13.5 A; red

	Item No.	Pack. Unit
● 2-way	2000-402/000-005	25
● 3-way	2000-403/000-005	25
● 4-way	2000-404/000-005	25
● 5-way	2000-405/000-005	25
● 6-way	2000-406/000-005	25
● 7-way	2000-407/000-005	25
● 8-way	2000-408/000-005	25
● 9-way	2000-409/000-005	25
● 10-way	2000-410/000-005	25

Push-in type jumper bar; insulated; I_N 13.5 A; blue

	Item No.	Pack. Unit
● 2-way	2000-402/000-006	25
● 3-way	2000-403/000-006	25
● 4-way	2000-404/000-006	25
● 5-way	2000-405/000-006	25
● 6-way	2000-406/000-006	25
● 7-way	2000-407/000-006	25
● 8-way	2000-408/000-006	25
● 9-way	2000-409/000-006	25
● 10-way	2000-410/000-006	25

Push-in type jumper bar; insulated; yellow-green

	Item No.	Pack. Unit
● 2-way	2000-402/000-018	25

Push-in type jumper bar; insulated; I_N 13.5 A; red

● 1 to 3	2000-433/000-005	25
----------	------------------	----

Push-in type jumper bar; insulated; I_N 13.5 A; blue

● 1 to 3	2000-433/000-006	25
----------	------------------	----

Push-in type jumper bar; insulated; I_N 25 A; red

● 2-way	2002-402/000-005	25
● 3-way	2002-403/000-005	25
● 4-way	2002-404/000-005	25
● 5-way	2002-405/000-005	25
● 6-way	2002-406/000-005	25
● 7-way	2002-407/000-005	25
● 8-way	2002-408/000-005	25
● 9-way	2002-409/000-005	25
● 10-way	2002-410/000-005	25

Push-in type jumper bar; insulated; I_N 25 A; blue

● 2-way	2002-402/000-006	25
● 3-way	2002-403/000-006	25
● 4-way	2002-404/000-006	25
● 5-way	2002-405/000-006	25
● 6-way	2002-406/000-006	25
● 7-way	2002-407/000-006	25
● 8-way	2002-408/000-006	25
● 9-way	2002-409/000-006	25
● 10-way	2002-410/000-006	25



For example, colored push-in type jumper bars are used with sensor terminal blocks.

Continuous Jumper TOPJOB® S 2002 Series

Technical Data	
800 V	
I_N 25 A	



Technical Data	
800 V / 8 kV / 3	
I_N 25 A	



Technical Data	
800 V / 8 kV / 3	
I_N 25 A	



Continuous jumper; insulated; 2-way		
	Item No.	Pack. Unit
○ light gray	2002-400	25
● red	2002-400/000-005	25
● blue	2002-400/000-006	25

Continuous jumper; insulated; 1 to 3		
Color	Item No.	Pack. Unit
○ light gray	2002-423	25
● red	2002-423/000-005	25
● blue	2002-423/000-006	25

Continuous jumper; insulated; light gray		
	Item No.	Pack. Unit
○ 1 to 3	2002-413	25
1 to 5	2002-415	25

Continuous jumper; insulated; 1 to 4		
Color	Item No.	Pack. Unit
○ light gray	2002-424	25
● red	2002-424/000-005	25
● blue	2002-424/000-006	25



Continuous jumpers (2002 Series) readily connect an endless number of terminal blocks to each other via single jumper slot. Use the second jumper slot for additional commoning or testing.



The 1-to-3 Continuous jumper enables every other terminal block to be commoned. For example, positive and negative potentials can be accommodated alongside each other.



Adjacent jumpers for continuous commoning (2002-400)

Staggered Jumper TOPJOB® S 2002 Series

1

Technical Data

400 V / 6 kV / 3
I_N 25 A

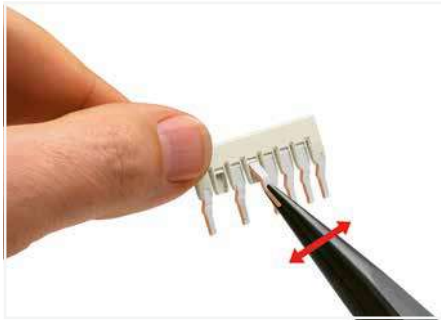

Staggered jumper (seven contacts):
Individual jumper contacts can be broken off by bending them. The remaining piece of insulation will meet requirements for clearances and creepage distances.



Staggered jumpers (seven contacts)

Staggered jumper; insulated; for 2002, 2003, 2022 and 2202 Series Rail-Mount Terminal Blocks; light gray

	Item No.	Pack. Unit
<input type="radio"/> 2-way	2002-472	25
<input type="radio"/> 3-way	2002-473	25
<input type="radio"/> 4-way	2002-474	25
<input type="radio"/> 5-way	2002-475	25
<input type="radio"/> 6-way	2002-476	25
<input type="radio"/> 7-way	2002-477	25
<input type="radio"/> 8-way	2002-478	25
<input type="radio"/> 9-way	2002-479	25
<input type="radio"/> 10-way	2002-480	25
<input type="radio"/> 11-way	2002-481	25
<input type="radio"/> 12-way	2002-482	25

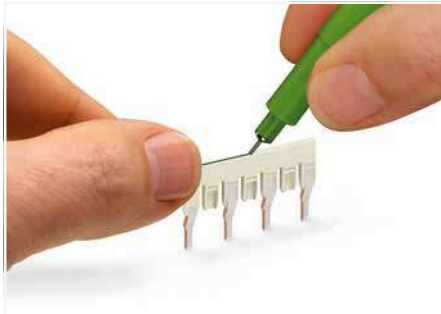

Staggered jumper:
Marking with a felt-tip pen.



Locate red stripes of the staggered jumpers on the inside. Insert staggered jumper and push down until it hits backstop.

Customized staggered jumper; insulated; with contact lugs broken off at the factory and circuit printing; light gray

<input type="radio"/> 1-3	2002-473/011-000	25
<input type="radio"/> 1-3-5	2002-475/011-000	25
<input type="radio"/> 1-3-5-7	2002-477/011-000	25
<input type="radio"/> 1-3-5-7-9	2002-479/011-000	25
<input type="radio"/> 1-3-5-7-9-11	2002-481/011-000	25

Commoning using staggered jumpers:

Individual jumper contacts can be broken off by bending them. The remaining piece of insulation will meet requirements for clearances and creepage distances. Custom staggered jumpers can be created, e.g., for bridging over a terminal block with a different potential. Make sure that only one contact lug is in contact with the terminal block.

The contact lugs of the customized staggered jumpers contact the terminal blocks via the gaps created in the second jumper. Insert and press the ready-made jumper assembly into the jumper slot until it hits backstop.



Staggering jumpers in a single jumper slot.
Custom staggered jumpers can be created, e.g., for bridging over a terminal block with a different potential. Make sure that only one contact lug is in contact with the terminal block.

The contact lugs of the customized staggered jumpers contact the terminal blocks via the gaps created in the second jumper. Insert and press the ready-made jumper assembly into the jumper slot until it hits backstop.

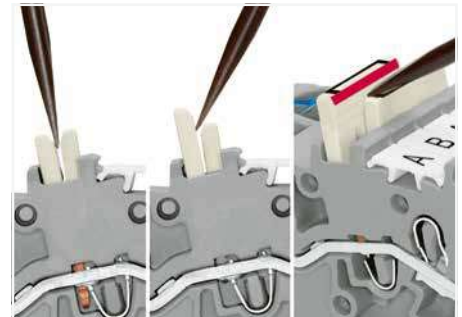

Removing a staggered jumper:
Insert the operating tool between the staggered jumpers, then lift up the jumper.



Commoning two potentials in one single jumper slot via extremely slim staggered jumpers.

Star Point Jumper, Delta Jumper, Collective Jumper Carrier TOPJOB® S

Technical Data
800 V / 8 kV / 3
$I_N = I_N$ terminal block

Technical Data
800 V / 8 kV / 3
$I_N = I_N$ terminal block



Star point jumper; insulated; 1-3-5; light gray		
	Item No.	Pack. Unit
<input type="radio"/>	2000-405/011-000	25
<input type="radio"/>	2001-405/011-000	25
<input type="radio"/>	2002-405/011-000	25
<input type="radio"/>	2004-405/011-000	25
<input type="radio"/>	2006-405/011-000	25
<input type="radio"/>	2010-405/011-000	25
<input type="radio"/>	2016-405/011-000	25

Delta jumper; insulated; 1-2 3-4 5-6; light gray		
	Item No.	Pack. Unit
<input type="radio"/>	2000-406/020-000	25
<input type="radio"/>	2001-406/020-000	25
<input type="radio"/>	2002-406/020-000	25
<input type="radio"/>	2004-406/020-000	25

Collective jumper carrier; for DIN-35 rail; for 2000 to 2016 Series jumpers		
Color	Item No.	Pack. Unit
<input type="radio"/> gray	2009-180	25

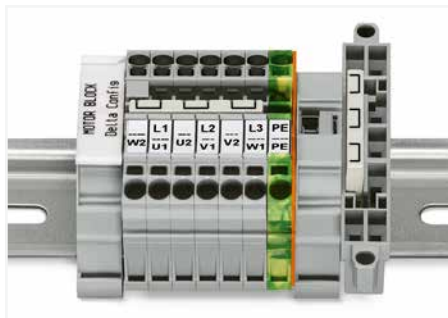

This star point jumper has been specially developed to create a "star point" and is used on motor terminal boards equipped with rail-mount terminal blocks TOPJOB® S.

This delta jumper has been specially developed to create a delta configuration and is used on motor terminal boards equipped with rail-mount terminal blocks TOPJOB® S.

Collective jumper carrier

Push-In Type Wire Jumper TOPJOB® S 2009 Series

1

Technical Data
800 V / 8 kV / 3
I _N 9 A

Technical Data
800 V / 8 kV / 3
I _N 18 A



Push-in type wire jumpers common terminal blocks over longer distances and across multiple levels.

Push-in type wire jumper; insulated; 0.75 mm² conductor cross-section; for 2000, 2020 and 2200 Series Rail-Mount Terminal Blocks; gray

	Item No.	Pack. Unit
L = 60 mm	2009-402	100 (10)
L = 110 mm	2009-404	100 (10)
L = 250 mm	2009-406	100 (10)

Push-in type wire jumper; insulated; 1.5 mm² conductor cross-section; for 2001, 2002, 2003, 2022, 2201 and 2202 Series Rail-Mount Terminal Blocks; black

	Item No.	Pack. Unit
L = 60 mm	2009-412	100 (10)
L = 110 mm	2009-414	100 (10)
L = 250 mm	2009-416	100 (10)



Push-in type wire jumper; insulated; L = 110 mm; 1.5 mm² conductor cross-section; for 2001, 2002, 2003, 2022, 2201 and 2202 Series Rail-Mount Terminal Blocks

Color	Item No.	Pack. Unit
● red	2009-414/000-005	100 (10)
● blue	2009-414/000-006	100 (10)

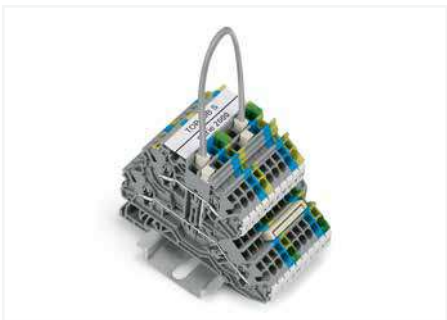

Push down the wire jumper until fully inserted. Lift the jumper with an operating tool for rewiring.

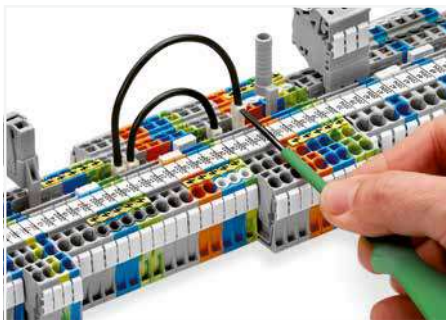

Push down the wire jumper until fully inserted. Lift the jumper with an operating tool for rewiring.

Vertical Jumper TOPJOB® S 2000 Series and 2002 Series

Technical Data	
500 V / 6 kV / 3	
I _N 13.5 A	



Technical Data	
500 V / 6 kV / 3	
I _N 24 A	



Technical Data	
500 V / 6 kV / 3	
I _N 24 A	



Double-deck vertical jumper; insulated		
Color	Item No.	Pack. Unit
○ light gray	2000-492	100 (25)

Double-deck vertical jumper; insulated		
Color	Item No.	Pack. Unit
○ light gray	2002-492	100 (25)
● orange	2002-492/000-012	100 (25)

Triple-deck vertical jumper; insulated		
Color	Item No.	Pack. Unit
○ light gray	2002-493	100 (25)

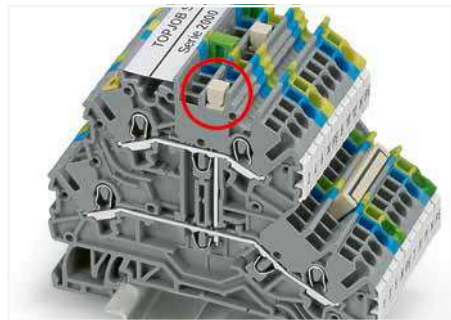

Commoning two levels via double-deck vertical jumper (2000-492).

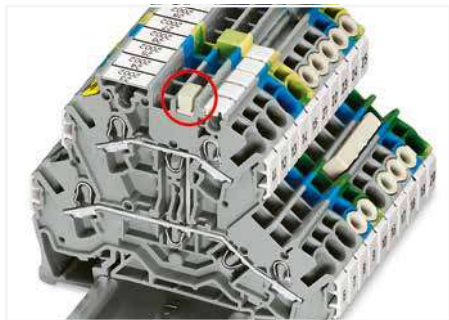

Commoning two levels via double-deck vertical jumper (2002-492).



Created for double- and triple-deck terminal blocks TOPJOB® S, the vertical jumpers can common two or three levels. Clearly marked numerals ("2" and "3") distinguish the double-deck (2002-492) and triple-deck vertical jumpers (2002-493), even when inserted.



Commoning three levels via triple-deck vertical jumper (2002-493).

Disconnect plug, Blind Plug for Carrier Terminal Block TOPJOB® S 2002 Series and 2006 Series

1

Technical Data

400 V / 6 kV / 3
I_N 10 A

Technical Data

800 V / 8 kV / 3
I_N 30 A



Disconnect plug for carrier terminal blocks; suitable when using a carrier terminal block as disconnect terminal block

Color	Item No.	Pack. Unit
● orange	2002-401	100 (25)

Disconnect plug for carrier terminal blocks; suitable when using a carrier terminal block as disconnect terminal block

Color	Item No.	Pack. Unit
● orange	2006-401	100 (25)
○ white	2006-401/000-050	100 (25)

Blind plug for carrier terminal block; indicates a disconnection

Color	Item No.	Pack. Unit
● red	2006-451	100 (25)



Carrier terminal block (2002-1661) with disconnect plug (2002-401) in operating position

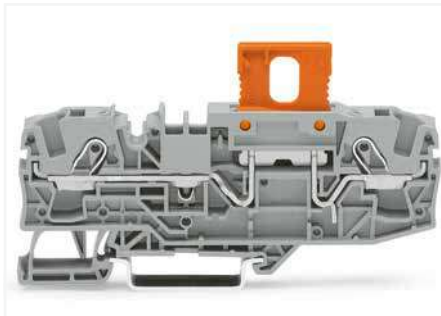

Carrier terminal block (2006-1661) with disconnect plug (2006-401) in operating position

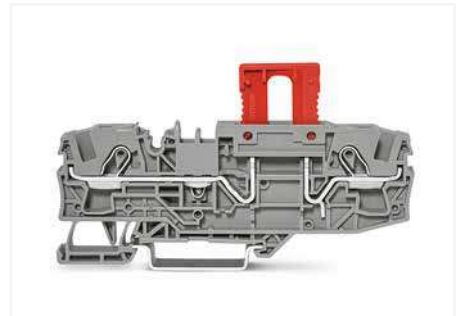

Blind plug (2006-451) for carrier terminal block; indicates a disconnection

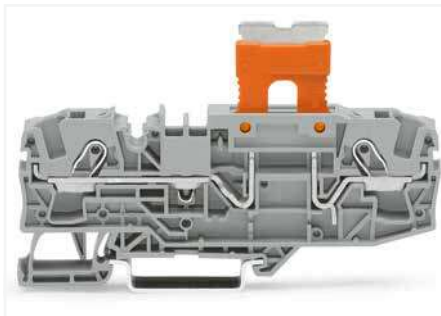

Carrier terminal block (2006-1661) with disconnect plug (2006-401) in parked position

Lockout Cap TOPJOB® S

2002 Series and 2006 Series

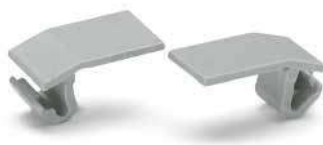

Lockout cap; for conductor entry and operating slot

Color	Item No.	Pack. Unit
orange	2002-192	25
gray	2002-191	25
blue	2002-194	25

Lockout cap; for conductor entry and operating slot

Color	Item No.	Pack. Unit
gray	2006-191	25



Creating spacer housings for electric motor wiring rail-mount terminal blocks via lockout caps (2002-192) for conductor entry and operating slot.



Cover (2006-191) seals unused conductor entry.

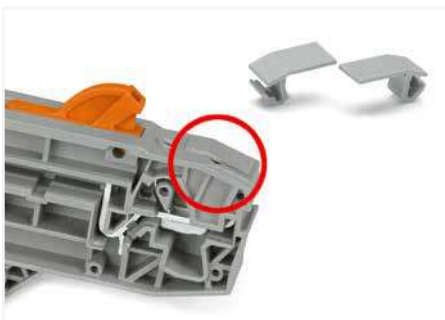

Cover (2006-191) seals unused conductor entry.

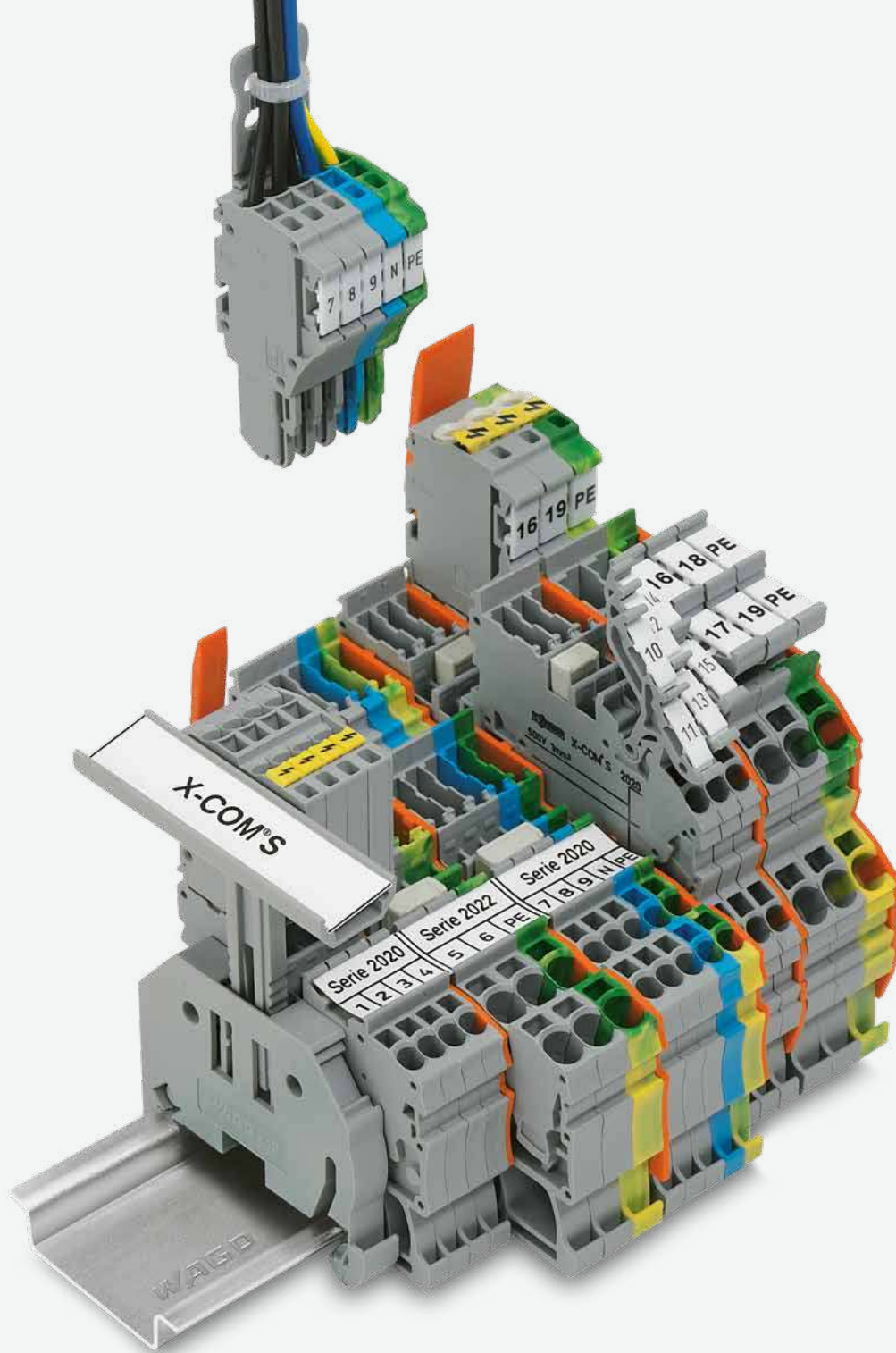

WAGO Rail-Mount Terminal Blocks with a Pluggable Connector X-COM[®]S-SYSTEM

WAGO Rail-Mount Terminal Blocks with a Pluggable Connector X-COM®S-SYSTEM

			Page
	X-COM®S-SYSTEM-MINI Through Carrier Terminal Blocks and Ground Conductor Carrier Terminal Blocks 0.14 ... 1 (1.5) mm ² (24 ... 16 AWG)	2020 Series	194
	Double-Deck Carrier Terminal Blocks 0.14 ... 1 (1.5) mm ² (24 ... 16 AWG)	2020 Series	196
	1-Conductor Female Plugs and 2-Conductor Female Plugs 0.14 ... 1 (1.5) mm ² (24 ... 16 AWG)	2020 Series	198
	1-Conductor Female Plugs and 2-Conductor Female Plugs for Self-Assembly 0.14 ... 1 (1.5) mm ² (24 ... 16 AWG)	2020 Series	200
	1-Conductor Female Plugs and 2-Conductor Female Plugs with Lateral Locking Levers and Strain Relief Plates 0.14 ... 1 (1.5) mm ² (24 ... 16 AWG)	2020 Series	202
	X-COM®S-SYSTEM Through Carrier Terminal Blocks and Ground Conductor Carrier Terminal Blocks; with/without Push-Buttons 0.25 ... 2.5 (4) mm ² (22 ... 12 AWG)	2222/2022 Series	210
	Double-Deck Carrier Terminal Blocks 0.25 ... 2.5 (4) mm ² (22 ... 12 AWG)	2022 Series	216
	1-Conductor Female Plugs 0.25 ... 2.5 (4) mm ² (22 ... 12 AWG)	2022 Series	218
	1-Conductor Female Plugs for Self-Assembly 0.25 ... 2.5 (4) mm ² (22 ... 12 AWG)	2022 Series	220
	1-Conductor Female Plugs with Lateral Locking Levers and Strain Relief Plates 0.25 ... 2.5 (4) mm ² (22 ... 12 AWG)	2022 Series	224
	X-COM®S-SYSTEM, for Exec Applications Through Carrier Terminal Blocks and Ground Conductor Carrier Terminal Blocks; with/without Push-Buttons	2222/2022 Series	226
	Double-Deck Carrier Terminal Blocks 0.25 ... 2.5 (4) mm ² (22 ... 12 AWG)		232
	1-Conductor Female Plugs 0.25 ... 2.5 (4) mm ² (22 ... 12 AWG)	2022 Series	234

X-COM®S-SYSTEM-MINI; 2020 Series X-COM®S-SYSTEM; 2022 Series Description and Installation

2

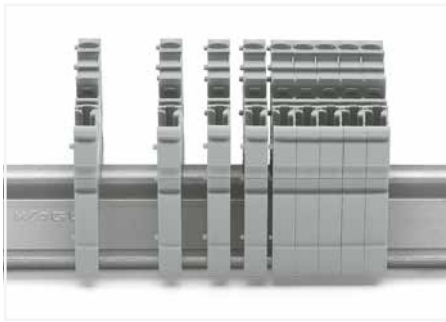

Snap individual carrier terminal blocks onto the DIN-rail and slide together.



Open the assembly by laterally sliding a block via operating tool (3.5 x 0.5 mm blade).

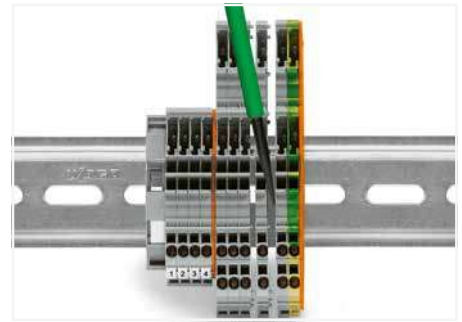

Separate terminal block assembly and slide individual terminal blocks laterally using an operating tool.



Carrier terminal blocks and female plugs are touch-proof.



Push-in CAGE CLAMP® enables solid conductors to be connected by simply pushing them into the unit.

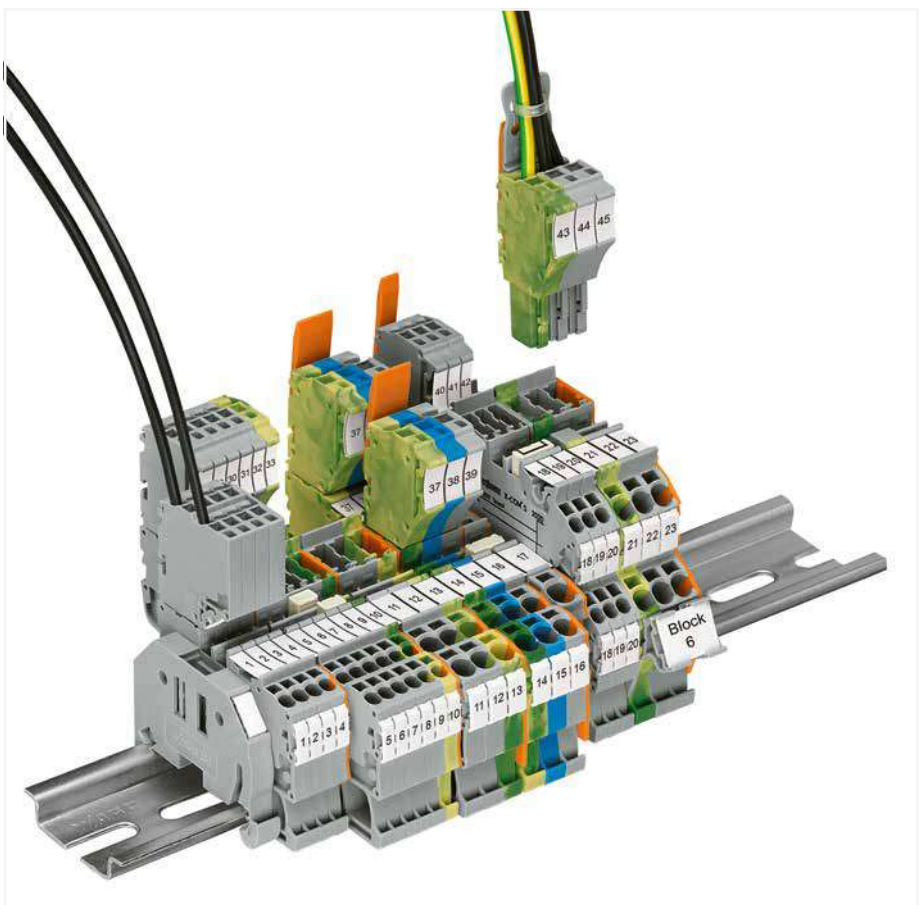

Note: Female plugs used according to the regulations must not be connected/disconnected when live or under load.

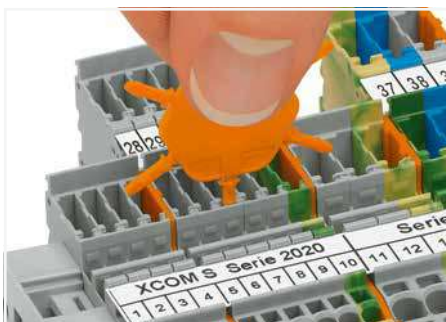

Insert coding pin into the corresponding slot and twist it off.



Coding a female plug: remove coding finger using a suitable tool.

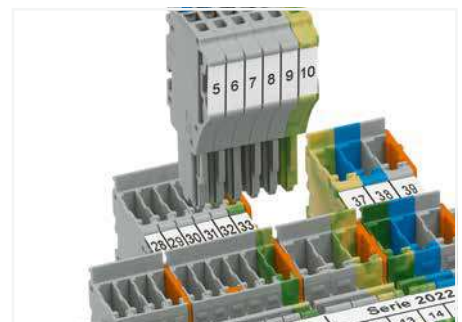

Insert coded female connector into X-COM®S-SYSTEM terminal block assembly.



Push-in CAGE CLAMP® terminates the following copper conductors:
solid "s"



stranded "st"



fine-stranded "f-st", also with tinned single strands

PUSH-IN CAGE CLAMP®

2

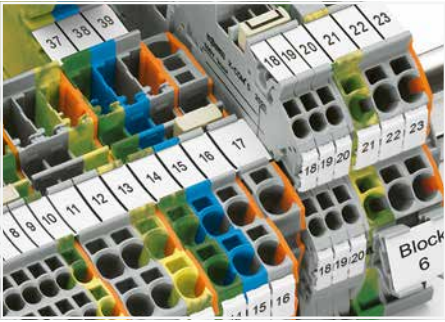

Commoning X-COM®S-SYSTEM Terminal Blocks using jumpers for Terminal Blocks TOPJOB® S. An end plate provides connection to Terminal Blocks TOPJOB® S. 2020 and 2022 Series Terminal Blocks are combinable. Jumper slots are on the same level for both series.



Pairing push-in comb style jumpers.

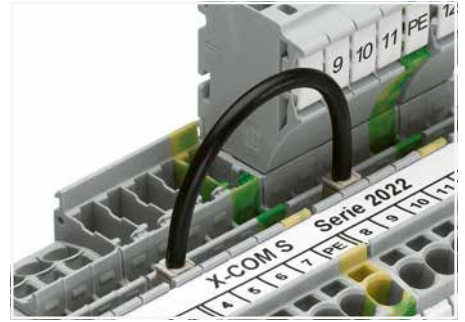

Commoning with push-in type wire jumper.

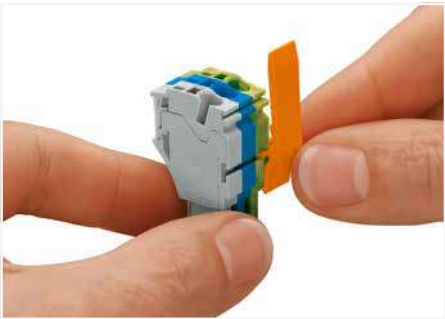

Slide the locking lever into position.

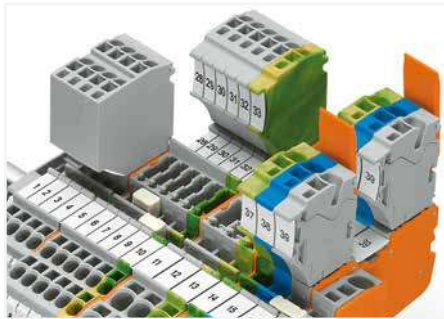

Female plugs can be individually locked.

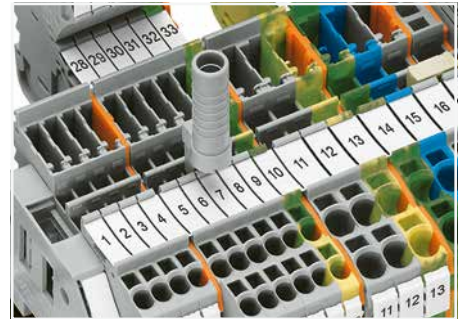

Test plug adapter (2009-174) for 4 mm test plugs or banana plugs – also suitable for X-COM®S-SYSTEM-MINI Terminal Blocks.

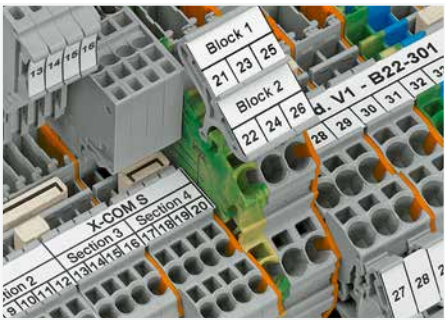

Clear marking via large marking area

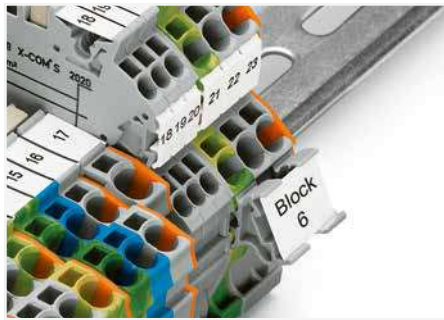

Marker carrier (2009-198)



fine-stranded, tip-bonded



fine-stranded, with ferrule (gastight crimped)



fine-stranded, with pin terminal (gastight crimped)

1-Conductor/1-Pin Carrier Terminal Block, 2-Conductor/1-Pin Carrier Terminal Block, 2-Conductor/2-Pin Carrier Terminal Block X-COM®S-SYSTEM-MINI 1 (1.5) mm²; 2020 Series

Technical Data	
0.14 ... 1 (1.5) mm ² ①	24 ... 16 AWG
500 V / 6 kV / 3 ②	300 V, 15 A ③
I _N 13.5 A ④	300 V, 10 A ⑤
Terminal block width: 3.5 mm / 0.138 inch	
9 ... 11 mm / 0.35 ... 0.43 inch	

Technical Data	
0.14 ... 1 (1.5) mm ² ①	24 ... 16 AWG
500 V / 6 kV / 3 ②	300 V, 15 A ③
I _N 13.5 A ④	300 V, 10 A ⑤
Terminal block width: 3.5 mm / 0.138 inch	
9 ... 11 mm / 0.35 ... 0.43 inch	

Technical Data	
0.14 ... 1 (1.5) mm ² ①	24 ... 16 AWG
500 V / 6 kV / 3 ②	300 V, 15 A ③
I _N 13.5 A ④	300 V, 10 A ⑤
Terminal block width: 3.5 mm / 0.138 inch	
9 ... 11 mm / 0.35 ... 0.43 inch	

2

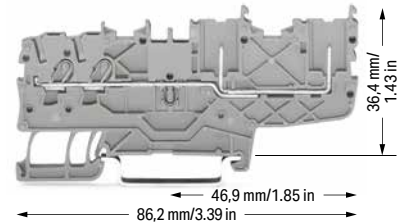
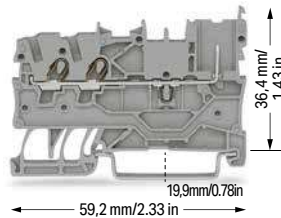
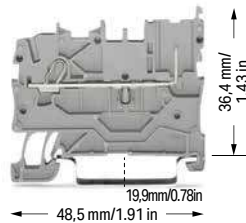

1-conductor/1-pin carrier terminal block		
Color	Item No.	Pack. Unit
gray	2020-1201	50
blue	2020-1204	50

2-conductor/1-pin carrier terminal block		
Color	Item No.	Pack. Unit
gray	2020-1301	50
blue	2020-1304	50

2-conductor/2-pin carrier terminal block		
Color	Item No.	Pack. Unit
gray	2020-1401	50
blue	2020-1404	50

1-conductor/1-pin ground carrier terminal block		
Color	Item No.	Pack. Unit
green-yellow	2020-1207	50

2-conductor/1-pin ground carrier terminal block		
Color	Item No.	Pack. Unit
green-yellow	2020-1307	50

2-conductor/2-pin ground carrier terminal block		
Color	Item No.	Pack. Unit
green-yellow	2020-1407	50

Accessories; item-specific			
End and intermediate plate; 1 mm thick			
	orange	2020-1292	100 (25)
	gray	2020-1291	100 (25)

Accessories; item-specific			
End and intermediate plate; 1 mm thick			
	orange	2020-1392	100 (25)
	gray	2020-1391	100 (25)

Accessories; item-specific			
End and intermediate plate; 1 mm thick			
	orange	2020-1492	100 (25)
	gray	2020-1491	100 (25)

Accessories; 2020 Series

Appropriate marking systems: WMB/WMB Inline/Marking strips

Push-in type jumper bar; insulated; I _N 13.5 A; light gray			
	2-way	2000-402	25
	3-way	2000-403	25
	4-way	2000-404	25
	5-way	2000-405	25
	6-way	2000-406	25
	7-way	2000-407	25
	8-way	2000-408	25
	9-way	2000-409	25
	10-way	2000-410	25

Protective warning marker; with black high-voltage symbol; for 5 terminal blocks			
	yellow	2000-115	100 (25)
Carrier with 6 coding pins; for coding female plugs			
	orange	2020-100	100 (25)
Test pin; 1 mm Ø			
		859-500	1
Test plug adapter; for 4 mm Ø test plug			
	gray	2009-174	100 (25)
Testing tap; for max. 2.5 mm ²			
	gray	2009-182	100 (25)

Marking strip; plain; 11 mm wide; 50 m reel			
	white	2009-110	1
WMB Inline; plain; 2,300 WMB markers (3.5 mm)/reel			
	white	2009-113	1
WMB marking card; white; 10 strips with 10 markers/card; for 3.5 mm terminal block width			
	plain	793-3501	5

Push-in type jumper bar; insulated; I _N 13.5 A; light gray			
	1 to 3	2000-433	25
	1 to 4	2000-434	25
	1 to 5	2000-435	25
	1 to 6	2000-436	25
	1 to 7	2000-437	25
	1 to 8	2000-438	25
	1 to 9	2000-439	25
	1 to 10	2000-440	25

1-conductor female plug			
	gray	2020-102	100

Delta jumper; insulated; I _N = I _N terminal block; light gray			
	1-2 3-4 5-6	2000-406/020-000	25

2-conductor female plug			
	gray	2020-202	100

Star point jumper; insulated; I _N = I _N terminal block; light gray			
	1-3-5	2000-405/011-000	25

Push-in type wire jumper; insulated; 0.75 mm ² conductor cross-section; I _N 9 A			
	L = 60 mm	2009-402	100 (10)
	L = 110 mm	2009-404	100 (10)
	L = 250 mm	2009-406	100 (10)

❶ Conductor range: 0.14 ... 1.5 mm² "s+f-st";
Push-in termination: 0.5 ... 1.5 mm² "s" and
0.5 ... 0.75 mm² "insulated ferrules; 10 mm"
Depending on the conductor characteristic, a conductor
with a smaller cross section can also be inserted
via push-in termination.

❷ 500 V = rated voltage
6 kV = rated impulse voltage
3 = pollution degree
(see Section 15)

❸ Current-carrying capacity curves upon request

Note:

When used as intended, female plugs must not be
connected/disconnected when live or under load.
An appropriate end plate must be applied to the
carrier terminal blocks after each female plug.

Please observe the application notes:
Jumpers, from page 182
Testing accessories, page 181
Marking, from page 684

Approvals and corresponding ratings,
visit www.wago.com

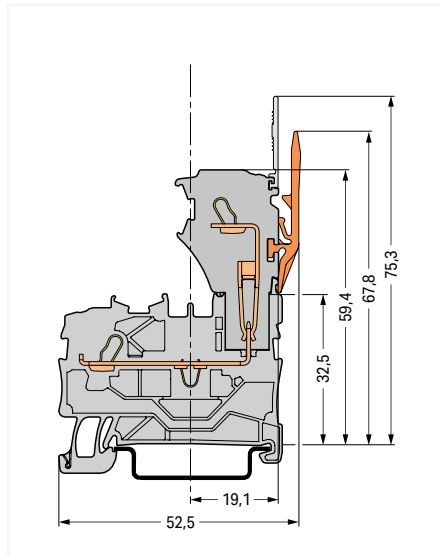

Carrier terminal block

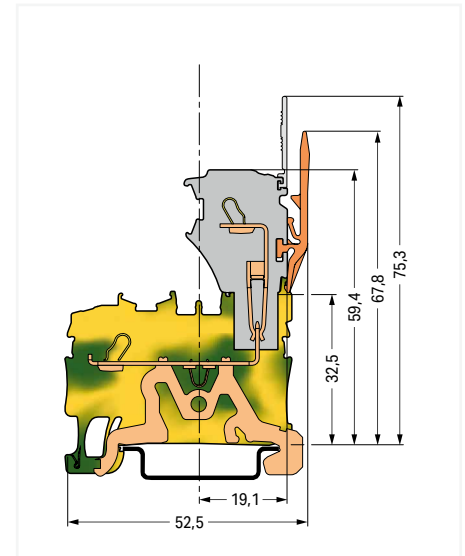

Ground carrier terminal block

1-Conductor/1-Pin Double-Deck Carrier Terminal Block X-COM®S-SYSTEM-MINI 1 (1.5) mm²; 2020 Series

Technical Data	
0.14 ... 1 (1.5) mm ² ①	24 ... 16 AWG
500 V / 6 kV / 3 ②	300 V, 15 A ③
I _N 13.5 A ④	300 V, 10 A ⑤
Terminal block width: 3.5 mm / 0.138 inch	
9 ... 11 mm / 0.35 ... 0.43 inch	

Technical Data	
0.14 ... 1 (1.5) mm ² ①	24 ... 16 AWG
500 V / 6 kV / 3 ②	300 V, 15 A ③
I _N 13.5 A ④	300 V, 10 A ⑤
Terminal block width: 3.5 mm / 0.138 inch	
9 ... 11 mm / 0.35 ... 0.43 inch	

Technical Data	
0.14 ... 1 (1.5) mm ² ①	24 ... 16 AWG
500 V / 6 kV / 3 ②	300 V, 15 A ③
I _N 13.5 A ④	300 V, 10 A ⑤
Terminal block width: 3.5 mm / 0.138 inch	
9 ... 11 mm / 0.35 ... 0.43 inch	

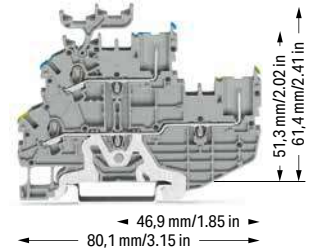
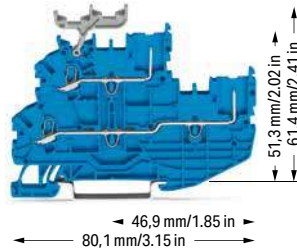
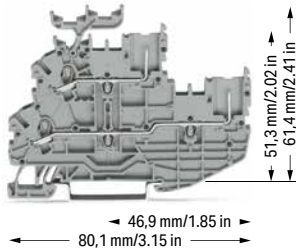

1-conductor/1-pin double-deck carrier terminal block; through/through terminal block; with marker carrier; gray

	Item No.	Pack. Unit
○ L/L	2020-2231	50
○ N/L	2020-2232	50
○ L/N	2020-2233	50

1-conductor/1-pin double-deck carrier terminal block; through/through terminal block; with marker carrier; blue

	Item No.	Pack. Unit
● N/N	2020-2234	50

1-conductor/1-pin double-deck carrier terminal block; ground conductor/through terminal block; with marker carrier; gray

	Item No.	Pack. Unit
○ PE/N	2020-2247	50
○ PE/L	2020-2257	50

1-conductor/1-pin double-deck carrier terminal block; through/through terminal block; without marker carrier; gray

○ L/L	2020-2201	50
○ N/L	2020-2202	50
○ L/N	2020-2203	50

1-conductor/1-pin double-deck carrier terminal block; through/through terminal block; without marker carrier; blue

● N/N	2020-2204	50
-------	-----------	----

1-conductor/1-pin double-deck carrier terminal block; ground conductor/through terminal block; without marker carrier; gray

○ PE/N	2020-2217	50
○ PE/L	2020-2227	50

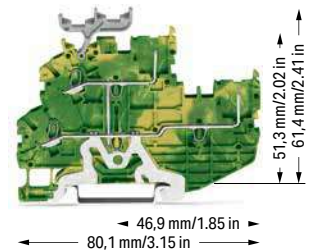
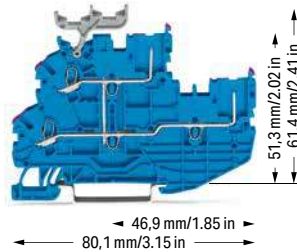
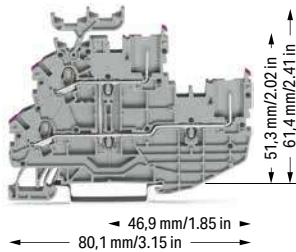

2-conductor/2-pin double-deck carrier terminal block; 2-conductor/2-pin through terminal block; with marker carrier, internally commoned; violet conductor entry; gray

	Item No.	Pack. Unit
○ L	2020-2238	50

2-conductor/2-pin double-deck carrier terminal block; 2-conductor/2-pin through terminal block; with marker carrier, internally commoned; violet conductor entry; blue

	Item No.	Pack. Unit
● N	2020-2239	50

2-conductor/2-pin double-deck carrier block; 2-conductor/2-pin ground conductor block; with marker carrier; internally commoned; green-yellow

	Item No.	Pack. Unit
● PE	2020-2237	50

2-conductor/2-pin double-deck carrier terminal block; 2-conductor/2-pin through terminal block; without marker carrier, internally commoned; violet conductor entry; gray

○ L	2020-2208	50
-----	-----------	----

2-conductor/2-pin double-deck carrier terminal block; 2-conductor/2-pin through terminal block; without marker carrier, internally commoned; violet conductor entry; blue

● N	2020-2209	50
-----	-----------	----

2-conductor/2-pin double-deck carrier block; 2-conductor/2-pin ground conductor block; without marker carrier; internally commoned; green-yellow

● PE	2020-2207	50
------	-----------	----

❶ Conductor range: 0.14 ... 1.5 mm² "s+f-st";
Push-in termination: 0.5 ... 1.5 mm² "s" and
0.5 ... 0.75 mm² "insulated ferrules; 10 mm"
Depending on the conductor characteristic, a conductor
with a smaller cross section can also be inserted
via push-in termination.

❷ 500 V = rated voltage
6 kV = rated impulse voltage
3 = pollution degree
(see Section 15)

❸ Current-carrying capacity curves upon request

Note:

When used as intended, female plugs must not be
connected/disconnected when live or under load.
An appropriate end plate must be applied to the
carrier terminal blocks after each female plug.

Please observe the application notes:
Jumpers, from page 182
Testing accessories, page 181
Marking, from page 684

Approvals and corresponding ratings,
visit www.wago.com

Accessories; 2020 Series

Appropriate marking systems:
WMB/WMB Inline/Marking strips

End and intermediate plate; 1 mm thick

	orange	2020-2292	100 (25)
	gray	2020-2291	100 (25)

Push-in type jumper bar; insulated; I_N 13.5 A; light gray

	2-way	2000-402	25
	3-way	2000-403	25
	4-way	2000-404	25
	5-way	2000-405	25
	6-way	2000-406	25
	7-way	2000-407	25
	8-way	2000-408	25
	9-way	2000-409	25
	10-way	2000-410	25

Push-in type jumper bar; insulated; I_N 13.5 A; light gray

	1 to 3	2000-433	25
	1 to 4	2000-434	25
	1 to 5	2000-435	25
	1 to 6	2000-436	25
	1 to 7	2000-437	25
	1 to 8	2000-438	25
	1 to 9	2000-439	25
	1 to 10	2000-440	25

Double-deck vertical jumper; insulated; I_N 13.5 A

	light gray	2000-492	100 (25)
---	------------	----------	----------

**Protective warning marker; with black high-voltage
symbol; for 5 terminal blocks**

	yellow	2000-115	100 (25)
---	--------	----------	----------

Carrier with 6 coding pins; for coding female plugs

	orange	2020-100	100 (25)
---	--------	----------	----------

Test pin; 1 mm Ø

		859-500	1
---	--	---------	---

Accessories; 2020 Series

Appropriate marking systems:
WMB/WMB Inline/Marking strips

Test plug adapter; for 4 mm Ø test plug

	gray	2009-174	100 (25)
---	------	----------	----------

Testing tap; for max. 2.5 mm²

	gray	2009-182	100 (25)
---	------	----------	----------

1-conductor female plug

	gray	2020-102	100
---	------	----------	-----

2-conductor female plug

	gray	2020-202	100
---	------	----------	-----

Marking strip; plain; 11 mm wide; 50 m reel

	white	2009-110	1
---	-------	----------	---

WMB Inline; plain; 2,300 WMB markers (3.5 mm)/reel

	white	2009-113	1
---	-------	----------	---

**WMB marking card; white; 10 strips with 10 markers/card;
for 3.5 mm terminal block width**

	plain	793-3501	5
---	-------	----------	---

Double-deck marker carrier; pivoting

	gray	2000-121	50 (25)
---	------	----------	---------



Size comparison:
Double-deck carrier terminal blocks with 3.5 mm and
5.2 mm terminal block widths

1-Conductor Female Plug, 2-Conductor Female Plug X-COM®S-SYSTEM-MINI

1 (1.5) mm²; 2020 Series

Technical Data	
0.14 ... 1 (1.5) mm ² ❶	24 ... 16 AWG
500 V / 6 kV / 3 ❷	300 V, 15 A ❸
I _N 13.5 A ❸	300 V, 10 A ❸
Module width: 3.5 mm / 0.138 inch	
9 ... 11 mm / 0.35 ... 0.43 inch	

Technical Data	
0.14 ... 1 (1.5) mm ² ❶	24 ... 16 AWG
500 V / 6 kV / 3 ❷	300 V, 15 A ❸
I _N 13.5 A ❸	300 V, 10 A ❸
Module width: 3.5 mm / 0.138 inch	
9 ... 11 mm / 0.35 ... 0.43 inch	

- ❶ Conductor range: 0.14 ... 1.5 mm² "s+f-st"; Push-in termination: 0.5 ... 1.5 mm² "s" and 0.5 ... 0.75 mm² "insulated ferrules; 10 mm" Depending on the conductor characteristic, a conductor with a smaller cross section can also be inserted via push-in termination.
- ❷ 500 V = rated voltage
6 kV = rated impulse voltage
3 = pollution degree (see Section 15)
- ❸ Current-carrying capacity curves upon request

Item no. suffixes
 blue .../000-006
 green-yellow .../000-016

Approvals and corresponding ratings, visit www.wago.com



Dimensions (in mm):

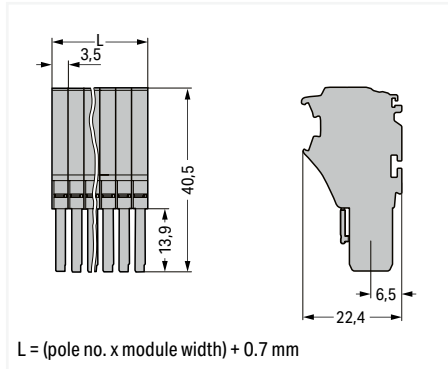

Dimensions (in mm):

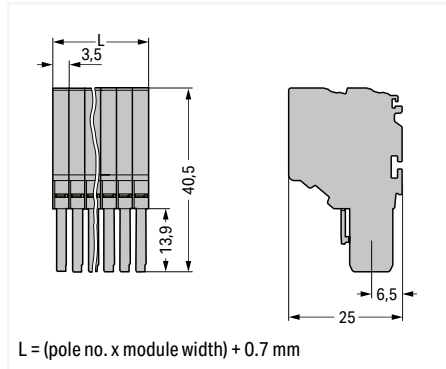

1-conductor female plug; fits into carrier terminal blocks; codable; gray
 According to EN 61984, pluggable connectors without a current interrupting capacity must not be mated or unmated when live or under load.
 Notice: An appropriate end plate must be applied to the carrier terminal blocks after each female plug.

2-conductor female plug; fits into carrier terminal blocks; codable; gray
 According to EN 61984, pluggable connectors without a current interrupting capacity must not be mated or unmated when live or under load.
 Notice: An appropriate end plate must be applied to the carrier terminal blocks after each female plug.

Pole No.	Item No.	Pack. Unit
2	2020-102	100
3	2020-103	50
4	2020-104	50
5	2020-105	50
6	2020-106	50
7	2020-107	25
8	2020-108	25
9	2020-109	25
10	2020-110	25
11	2020-111	20
12	2020-112	20
13	2020-113	10
14	2020-114	10
15	2020-115	10

Pole No.	Item No.	Pack. Unit
2	2020-202	100
3	2020-203	50
4	2020-204	50
5	2020-205	50
6	2020-206	25
7	2020-207	25
8	2020-208	25
9	2020-209	25
10	2020-210	25
11	2020-211	20
12	2020-212	20
13	2020-213	10
14	2020-214	10
15	2020-215	10

Accessories; for female plugs

Appropriate marking systems: WMB/WMB Inline

Protective warning marker; with black high-voltage symbol; for 5 terminal blocks

yellow	2000-115	100 (25)
--------	----------	----------



Locking lever; 4.8 mm wide

orange	2022-142	100 (25)
gray	2022-141	100 (25)



Carrier with 6 coding pins; for coding female plugs

orange	2020-100	100 (25)
--------	----------	----------



Locking lever; 9.6 mm wide

orange	2022-152	100 (25)
gray	2022-151	100 (25)



X-COM®S-SYSTEM terminal block assembly

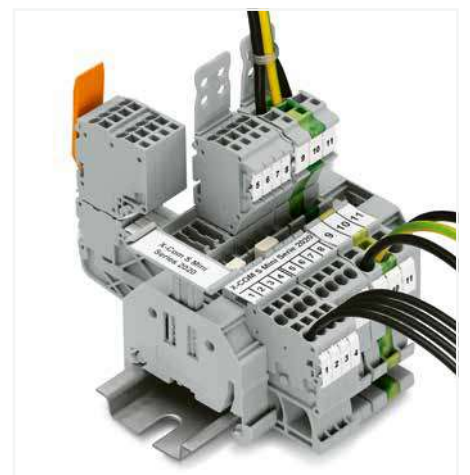

X-COM®S-SYSTEM terminal block assembly

Carrier Terminal Blocks and 1-/2-Conductor Female Plugs X-COM®S-SYSTEM-MINI Types of Assembly

2



1-conductor female plug
Carrier terminal blocks can be commoned via 2000 Series Push-In Type Jumper Bars and tested via 859-500 Test Pin.

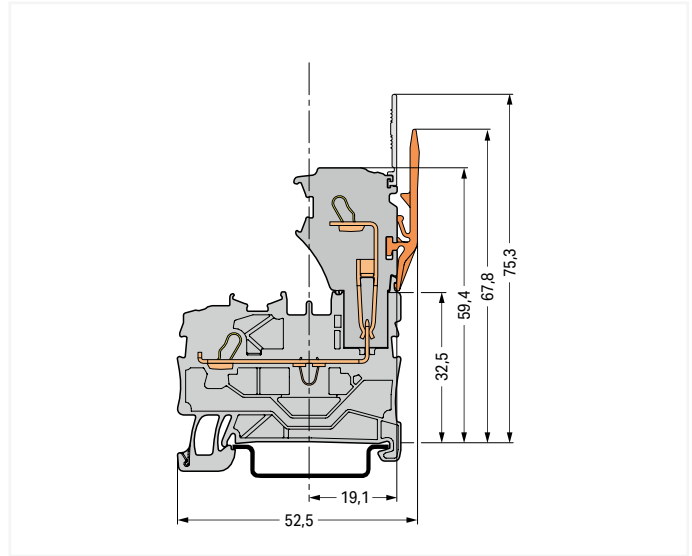

Carrier terminal block

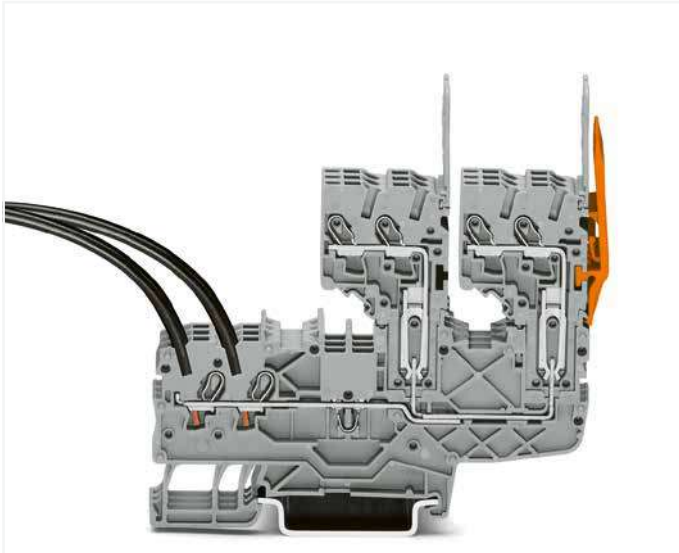

2-conductor female plug
Carrier terminal blocks can be commoned via 2000 Series Push-In Type Jumper Bars and tested via 859-500 Test Pin.

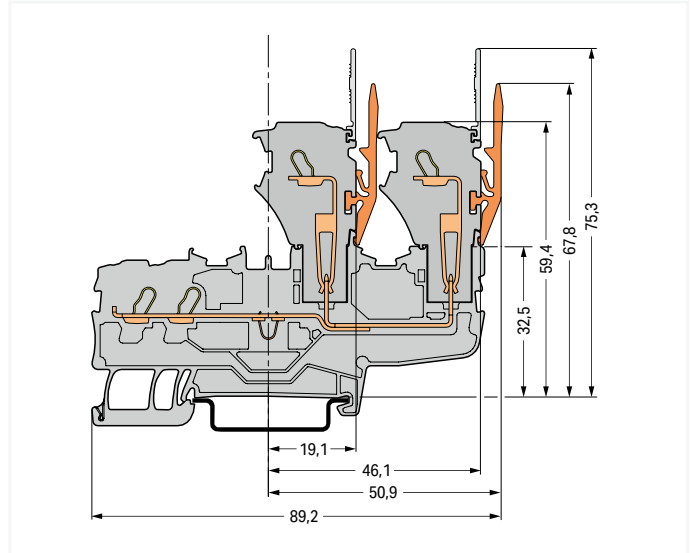

Carrier terminal block

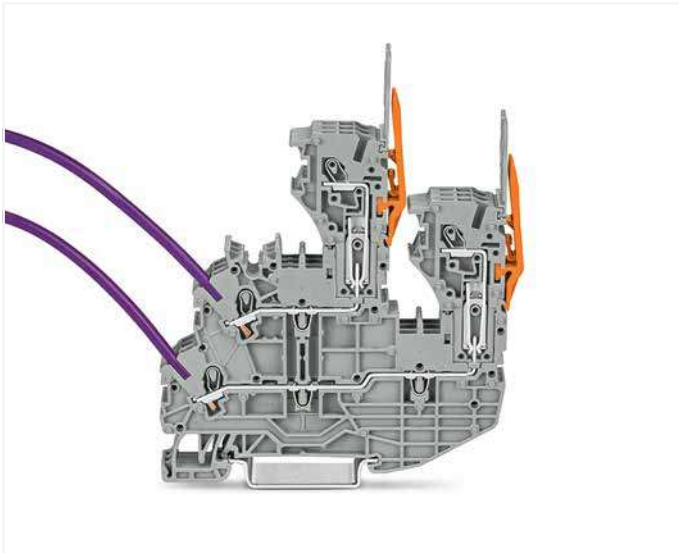

1-conductor female plug
Double-deck carrier terminal blocks can be commoned via 2000 Series Push-In Type Jumper Bars and tested via 859-500 Test Pin.

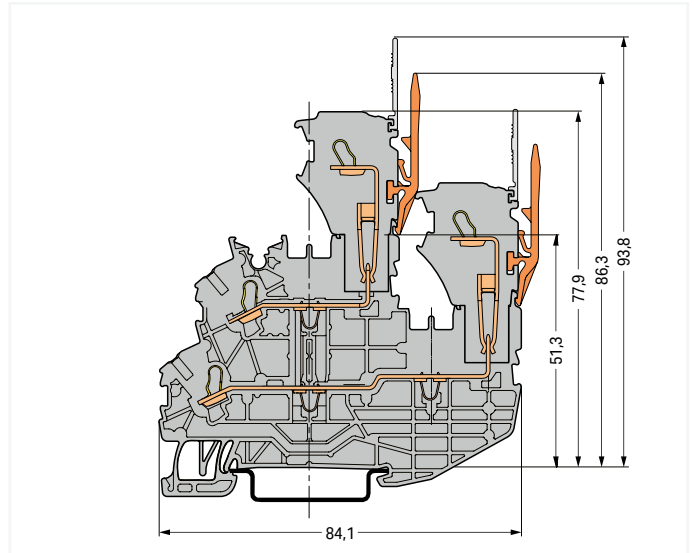

Double-deck carrier terminal block

Female Plug for Self-Assembly X-COM®S-SYSTEM-MINI 1 (1.5) mm²; 2020 Series

Technical Data

0.14 ... 1 (1.5) mm ² ❶	24 ... 16 AWG
500 V / 6 kV / 3 ❷	300 V, 15 A ❸
I _N 13.5 A ❸	300 V, 10 A ❹
Terminal block width: 3.5 mm / 0.138 inch	
 9 ... 11 mm / 0.35 ... 0.43 inch	

Technical Data

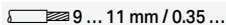
0.14 ... 1 (1.5) mm ² ❶	24 ... 16 AWG
500 V / 6 kV / 3 ❷	300 V, 15 A ❸
I _N 13.5 A ❸	300 V, 10 A ❹
Terminal block width: 3.5 mm / 0.138 inch	
 9 ... 11 mm / 0.35 ... 0.43 inch	

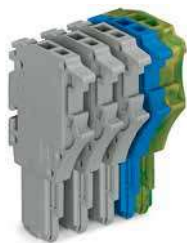

❶ Conductor range: 0.14 ... 1.5 mm² "s+f-st"; Push-in termination: 0.5 ... 1.5 mm² "s" and 0.5 ... 0.75 mm² "insulated ferrules; 10 mm" Depending on the conductor characteristic, a conductor with a smaller cross section can also be inserted via push-in termination.

❷ 500 V = rated voltage
6 kV = rated impulse voltage
3 = pollution degree (see Section 15)

❸ Current-carrying capacity curves upon request



Note:

According to EN 61984, pluggable connectors without a current interrupting capacity must not be mated or unmated when live or under load.



Notice: An appropriate end plate must be applied to the carrier terminal blocks after each female plug.

Approvals and corresponding ratings, visit www.wago.com



1-conductor end module; codable

Color	Item No.	Pack. Unit
 gray	2020-181	250
 blue	2020-184	250
 green-yellow	2020-187	250



2-conductor end module; codable

Color	Item No.	Pack. Unit
 gray	2020-281	250
 blue	2020-284	250
 green-yellow	2020-287	250

1-conductor base module; with end plate; codable

 gray	2020-161	250
 blue	2020-164	250
 green-yellow	2020-167	250

2-conductor base module; with end plate; codable

 gray	2020-261	250
 blue	2020-264	250
 green-yellow	2020-267	250

Accessories; for female plugs

Appropriate marking systems: WMB/WMB Inline

Protective warning marker; with black high-voltage symbol; for 5 terminal blocks

 yellow	2000-115	100 (25)
--	----------	----------

Carrier with 6 coding pins; for coding female plugs

 orange	2020-100	100 (25)
--	----------	----------

Locking lever; 4.8 mm wide

 orange	2022-142	100 (25)
 gray	2022-141	100 (25)

Locking lever; 9.6 mm wide

 orange	2022-152	100 (25)
 gray	2022-151	100 (25)

Strain relief plate; gray

 35 mm wide	734-326	100 (25)
6 mm wide	734-327	100 (25)
12.5 mm wide	734-328	100 (25)
25 mm wide	734-329	100 (25)

WMB Inline; plain; 2,300 WMB markers (3.5 mm)/reel

 white	2009-113	1
--	----------	---

WMB marking card; white; 10 strips with 10 markers/card; for 3.5 mm terminal block width

 plain	793-3501	5
--	----------	---

Customizing Modular Female Plugs

WAGO's modular X-COM®S-SYSTEM female plugs can be customized for applications requiring varying numbers of poles (e.g., when designing prototypes).

Modules and Pole Numbers

A customized X-COM®S-SYSTEM-MINI female plug consists of:

- One base module with end plate
- Up to 14 end modules

Intended Use

According to EN 61984, pluggable connectors without a current interrupting capacity must not be mated or unmated when live or under load.

Mounting

The appropriate mounting tool shall be used in order to guarantee that the individual modules are properly attached to each other without damaging the locking latches.



End module



Base module

Example: 5-Pole, 1-Conductor Female Plug

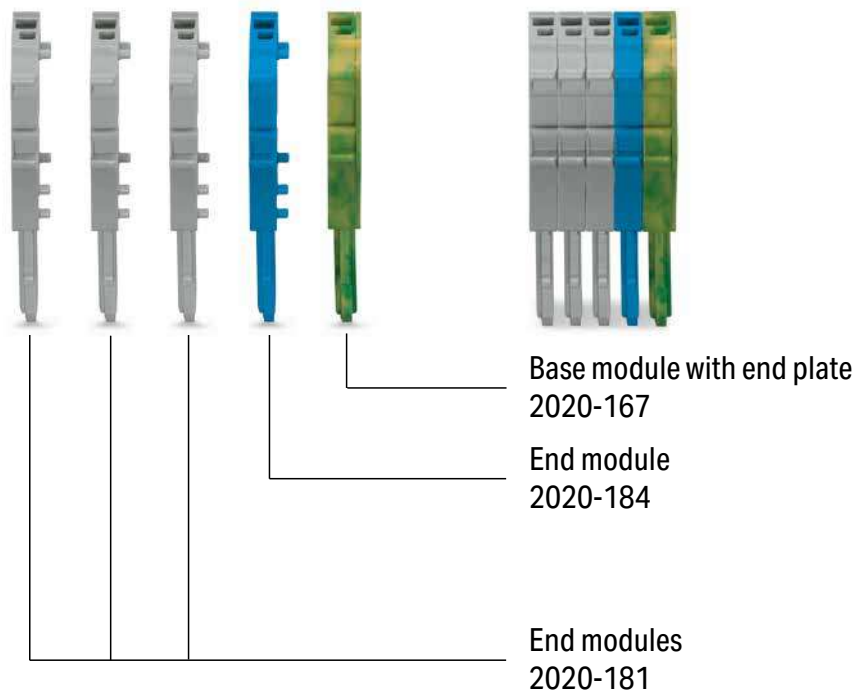

Pre-Assembled 1-Conductor Female Plug X-COM®S-SYSTEM-MINI 1 (1.5) mm²; 2020 Series

Technical Data

0.14 ... 1 (1.5) mm ² ①	24 ... 16 AWG
500 V / 6 kV / 3 ②	300 V, 15 A ④
I _N 13.5 A ③	300 V, 10 A ⑤

Module width: 3.5 mm / 0.138 inch

Technical Data

0.14 ... 1 (1.5) mm ² ①	24 ... 16 AWG
500 V / 6 kV / 3 ②	300 V, 15 A ④
I _N 13.5 A ③	300 V, 10 A ⑤

Module width: 3.5 mm / 0.138 inch

Technical Data

0.14 ... 1 (1.5) mm ² ①	24 ... 16 AWG
500 V / 6 kV / 3 ②	300 V, 15 A ④
I _N 13.5 A ③	300 V, 10 A ⑤

Module width: 3.5 mm / 0.138 inch

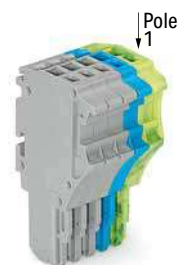

1-conductor female plug; with ground base module (green-yellow); fits into carrier terminal blocks; codable

Pole No.	Item No.	Pack. Unit
3	2020-103/000-036	50
4	2020-104/000-036	50
5	2020-105/000-036	50
6	2020-106/000-036	50
7	2020-107/000-036	25
8	2020-108/000-036	25
9	2020-109/000-036	25
10	2020-110/000-036	25
11	2020-111/000-036	20
12	2020-112/000-036	20
13	2020-113/000-036	10
14	2020-114/000-036	10
15	2020-115/000-036	10

1-conductor female plug; with ground end module (green-yellow); fits into carrier terminal blocks; codable

Pole No.	Item No.	Pack. Unit
3	2020-103/000-037	50
4	2020-104/000-037	50
5	2020-105/000-037	50
6	2020-106/000-037	50
7	2020-107/000-037	25
8	2020-108/000-037	25
9	2020-109/000-037	25
10	2020-110/000-037	25
11	2020-111/000-037	20
12	2020-112/000-037	20
13	2020-113/000-037	10
14	2020-114/000-037	10
15	2020-115/000-037	10

1-conductor female plug; with ground base module (green-yellow); fits into carrier terminal blocks; codable

Pole No.	Item No.	Pack. Unit
3	2020-103/000-038	50
4	2020-104/000-038	50
5	2020-105/000-038	50
6	2020-106/000-038	50
7	2020-107/000-038	25
8	2020-108/000-038	25
9	2020-109/000-038	25
10	2020-110/000-038	25
11	2020-111/000-038	20
12	2020-112/000-038	20
13	2020-113/000-038	10
14	2020-114/000-038	10
15	2020-115/000-038	10

Accessories; for female plugs

Appropriate marking systems: WMB/WMB Inline/Marking strips

Protective warning marker; with black high-voltage symbol; for 5 terminal blocks

yellow	2000-115	100 (25)
--------	----------	----------



Marking strip; plain; 11 mm wide; 50 m reel

white	2009-110	1
-------	----------	---



Carrier with 6 coding pins; for coding female plugs

orange	2020-100	100 (25)
--------	----------	----------



WMB Inline; plain; 2,300 WMB markers (3.5 mm)/reel

white	2009-113	1
-------	----------	---



Locking lever; 4.8 mm wide

orange	2022-142	100 (25)
gray	2022-141	100 (25)



WMB marking card; white; 10 strips with 10 markers/card; for 3.5 mm terminal block width

plain	793-3501	5
-------	----------	---



Locking lever; 9.6 mm wide

orange	2022-152	100 (25)
gray	2022-151	100 (25)



Strain relief plate; gray

35 mm wide	734-326	100 (25)
6 mm wide	734-327	100 (25)
12.5 mm wide	734-328	100 (25)
25 mm wide	734-329	100 (25)



Technical Data

0.14 ... 1 (1.5) mm² ① | 24 ... 16 AWG

500 V / 6 kV / 3 ② | 300 V, 15 A ③

I_N 13.5 A ③ | 300 V, 10 A ③

Module width: 3.5 mm / 0.138 inch

9 ... 11 mm / 0.35 ... 0.43 inch



① Conductor range: 0.14 ... 1.5 mm² "s+f-st";
Push-in termination: 0.5 ... 1.5 mm² "s" and
0.5 ... 0.75 mm² "insulated ferrules; 10 mm"
Depending on the conductor characteristic, a conduc-
tor with a smaller cross section can also be inserted
via push-in termination.

② 500 V = rated voltage
6 kV = rated impulse voltage
3 = pollution degree
(see Section 15)

③ Current-carrying capacity curves upon request

Note:

According to EN 61984, pluggable connectors without
a current interrupting capacity must not be mated or
unmated when live or under load.

Notice: An appropriate end plate must be applied to
the carrier terminal blocks after each female plug.

Approvals and corresponding ratings,
visit www.wago.com

1-conductor female plug; with ground end module
(green-yellow); fits into carrier terminal blocks; codable

Pole No.	Item No.	Pack. Unit
3	2020-103/000-039	50
4	2020-104/000-039	50
5	2020-105/000-039	50
6	2020-106/000-039	50
7	2020-107/000-039	25
8	2020-108/000-039	25
9	2020-109/000-039	25
10	2020-110/000-039	25
11	2020-111/000-039	20
12	2020-112/000-039	20
13	2020-113/000-039	10
14	2020-114/000-039	10
15	2020-115/000-039	10

Pre-Assembled 2-Conductor Female Plug X-COM®S-SYSTEM-MINI 1 (1.5) mm²; 2020 Series

Technical Data

0.14 ... 1 (1.5) mm ² ①	24 ... 16 AWG
500 V / 6 kV / 3 ②	300 V, 15 A ③
I _N 13.5 A ④	300 V, 10 A ⑤

Module width: 3.5 mm / 0.138 inch

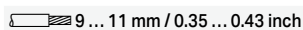

Technical Data

0.14 ... 1 (1.5) mm ² ①	24 ... 16 AWG
500 V / 6 kV / 3 ②	300 V, 15 A ③
I _N 13.5 A ④	300 V, 10 A ⑤

Module width: 3.5 mm / 0.138 inch

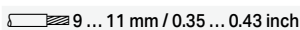

Technical Data

0.14 ... 1 (1.5) mm ² ①	24 ... 16 AWG
500 V / 6 kV / 3 ②	300 V, 15 A ③
I _N 13.5 A ④	300 V, 10 A ⑤

Module width: 3.5 mm / 0.138 inch

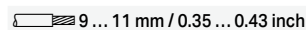
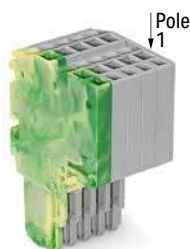
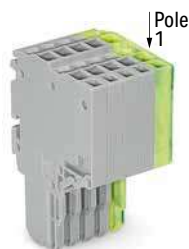
2-conductor female plug; with ground base module (green-yellow); fits into carrier terminal blocks; codable

Pole No.	Item No.	Pack. Unit
3	2020-203/000-036	50
4	2020-204/000-036	50
5	2020-205/000-036	50
6	2020-206/000-036	50
7	2020-207/000-036	25
8	2020-208/000-036	25
9	2020-209/000-036	25
10	2020-210/000-036	25
11	2020-211/000-036	20
12	2020-212/000-036	20
13	2020-213/000-036	10
14	2020-214/000-036	10
15	2020-215/000-036	10

2-conductor female plug; with ground end module (green-yellow); fits into carrier terminal blocks; codable

Pole No.	Item No.	Pack. Unit
3	2020-203/000-037	50
4	2020-204/000-037	50
5	2020-205/000-037	50
6	2020-206/000-037	50
7	2020-207/000-037	25
8	2020-208/000-037	25
9	2020-209/000-037	25
10	2020-210/000-037	25
11	2020-211/000-037	20
12	2020-212/000-037	20
13	2020-213/000-037	10
14	2020-214/000-037	10
15	2020-215/000-037	10

2-conductor female plug; with ground base module (green-yellow); fits into carrier terminal blocks; codable

Pole No.	Item No.	Pack. Unit
3	2020-203/000-038	50
4	2020-204/000-038	50
5	2020-205/000-038	50
6	2020-206/000-038	50
7	2020-207/000-038	25
8	2020-208/000-038	25
9	2020-209/000-038	25
10	2020-210/000-038	25
11	2020-211/000-038	20
12	2020-212/000-038	20
13	2020-213/000-038	10
14	2020-214/000-038	10
15	2020-215/000-038	10

Accessories; for female plugs

Appropriate marking systems: WMB/WMB Inline

Protective warning marker; with black high-voltage symbol; for 5 terminal blocks



yellow	2000-115	100 (25)
--------	----------	----------

Carrier with 6 coding pins; for coding female plugs



orange	2020-100	100 (25)
--------	----------	----------

Locking lever; 4,8 mm wide



orange	2022-142	100 (25)
gray	2022-141	100 (25)

Locking lever; 9,6 mm wide



orange	2022-152	100 (25)
gray	2022-151	100 (25)

Strain relief plate; gray



35 mm wide	734-326	100 (25)
6 mm wide	734-327	100 (25)
12.5 mm wide	734-328	100 (25)
25 mm wide	734-329	100 (25)

WMB Inline; plain; 2,300 WMB markers (3.5 mm)/reel



white	2009-113	1
-------	----------	---

WMB marking card; white; 10 strips with 10 markers/card; for 3.5 mm terminal block width



plain	793-3501	5
-------	----------	---

Technical Data

0.14 ... 1 (1.5) mm² ① | 24 ... 16 AWG

500 V / 6 kV / 3 ② | 300 V, 15 A ③

I_N 13.5 A ③ | 300 V, 10 A ③

Module width: 3.5 mm / 0.138 inch

9 ... 11 mm / 0.35 ... 0.43 inch

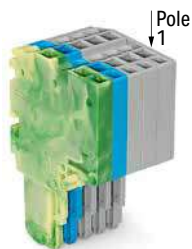

2-conductor female plug; with ground end module (green-yellow); fits into carrier terminal blocks; codable

Pole No.	Item No.	Pack. Unit
3	2020-203/000-039	50
4	2020-204/000-039	50
5	2020-205/000-039	50
6	2020-206/000-039	50
7	2020-207/000-039	25
8	2020-208/000-039	25
9	2020-209/000-039	25
10	2020-210/000-039	25
11	2020-211/000-039	20
12	2020-212/000-039	20
13	2020-213/000-039	10
14	2020-214/000-039	10
15	2020-215/000-039	10

① Conductor range: 0.14 ... 1.5 mm² "s+f-st";
Push-in termination: 0.5 ... 1.5 mm² "s" and
0.5 ... 0.75 mm² "insulated ferrules; 10 mm"
Depending on the conductor characteristic, a conductor
with a smaller cross section can also be inserted
via push-in termination.

② 500 V = rated voltage
6 kV = rated impulse voltage
3 = pollution degree
(see Section 15)

③ Current-carrying capacity curves upon request

Note:

According to EN 61984, pluggable connectors without
a current interrupting capacity must not be mated or
unmated when live or under load.

Notice: An appropriate end plate must be applied to
the carrier terminal blocks after each female plug.

Approvals and corresponding ratings,
visit www.wago.com

1-Conductor Female Plug X-COM®S-SYSTEM-MINI; with Lateral Locking Lever and Strain Relief Plate

1 (1.5) mm²; 2020 Series

Technical Data	
0.14 ... 1 (1.5) mm ² ①	24 ... 16 AWG
500 V / 6 kV / 3 ②	300 V, 15 A ③
I _N 13.5 A ④	300 V, 10 A ⑤
Module width: 3.5 mm / 0.138 inch	
9 ... 11 mm / 0.35 ... 0.43 inch	

Technical Data	
0.14 ... 1 (1.5) mm ² ①	24 ... 16 AWG
500 V / 6 kV / 3 ②	300 V, 15 A ③
I _N 13.5 A ④	300 V, 10 A ⑤
Module width: 3.5 mm / 0.138 inch	
9 ... 11 mm / 0.35 ... 0.43 inch	

Technical Data	
0.14 ... 1 (1.5) mm ² ①	24 ... 16 AWG
500 V / 6 kV / 3 ②	300 V, 15 A ③
I _N 13.5 A ④	300 V, 10 A ⑤
Module width: 3.5 mm / 0.138 inch	
9 ... 11 mm / 0.35 ... 0.43 inch	

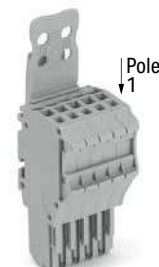

1-conductor female plug; with locking lever; fits into carrier terminal blocks; codable; gray

Pole No.	Item No.	Pack. Unit
2	2020-102/122-000	100
3	2020-103/122-000	50
4	2020-104/124-000	50
5	2020-105/124-000	50
6	2020-106/124-000	25
7	2020-107/124-000	25
8	2020-108/124-000	25
9	2020-109/124-000	25
10	2020-110/125-000	25
11	2020-111/125-000	20
12	2020-112/125-000	20
13	2020-113/125-000	10
14	2020-114/125-000	10
15	2020-115/125-000	10

1-conductor female plug; with strain relief plate; fits into carrier terminal blocks; codable; gray

Pole No.	Item No.	Pack. Unit
2	2020-102/132-000	100
3	2020-103/132-000	50
4	2020-104/133-000	50
5	2020-105/133-000	50
6	2020-106/133-000	25
7	2020-107/134-000	25
8	2020-108/134-000	25
9	2020-109/134-000	25
10	2020-110/135-000	25
11	2020-111/135-000	20
12	2020-112/135-000	20
13	2020-113/135-000	10
14	2020-114/135-000	10
15	2020-115/135-000	10

1-conductor female plug; with strain relief plate and locking lever; fits into carrier terminal blocks; codable; gray

Pole No.	Item No.	Pack. Unit
2	2020-102/142-000	100
3	2020-103/142-000	50
4	2020-104/143-000	50
5	2020-105/143-000	50
6	2020-106/143-000	25
7	2020-107/144-000	25
8	2020-108/144-000	25
9	2020-109/144-000	25
10	2020-110/145-000	25
11	2020-111/145-000	20
12	2020-112/145-000	20
13	2020-113/145-000	10
14	2020-114/145-000	10
15	2020-115/145-000	10

Accessories; for female plugs

Appropriate marking systems: WMB/WMB Inline/Marking strips

Protective warning marker; with black high-voltage symbol; for 5 terminal blocks

yellow	2000-115	100 (25)
--------	----------	----------



Carrier with 6 coding pins; for coding female plugs

orange	2020-100	100 (25)
--------	----------	----------



Marking strip; plain; 11 mm wide; 50 m reel

white	2009-110	1
-------	----------	---



WMB Inline; plain; 2,300 WMB markers (3.5 mm)/reel

white	2009-113	1
-------	----------	---



WMB marking card; white; 10 strips with 10 markers/card; for 3.5 mm terminal block width

plain	793-3501	5
-------	----------	---



❶ Conductor range: 0.14 ... 1.5 mm² "s+f-st";
 Push-in termination: 0.5 ... 1.5 mm² "s" and
 0.5 ... 0.75 mm² "insulated ferrules; 10 mm"
 Depending on the conductor characteristic, a conductor
 with a smaller cross section can also be inserted
 via push-in termination.

❷ 500 V = rated voltage
 6 kV = rated impulse voltage
 3 = pollution degree
 (see Section 15)

❸ Current-carrying capacity curves upon request

Note:
 According to EN 61984, pluggable connectors without
 a current interrupting capacity must not be mated or
 unmated when live or under load.
 Notice: An appropriate end plate must be applied to
 the carrier terminal blocks after each female plug.

Approvals and corresponding ratings,
 visit www.wago.com

Strain Relief Plate (SRP), Gray				Locking Lever (LL), Gray				SRP and LL, Gray
Assembled				Assembled				Assembled
SRP				Pole No.	Quantity	1-Way	2-Way	
Item No. Suffix				Item No. Suffix				Item No. Suffix
Item No.	Color	Width						
734-327	gray	6mm	/132-0xx	2 to 3	1	/122-0xx	-	/142-0xx
734-328	gray	12.5mm	/133-0xx	4 to 6	1	-	/124-0xx	/143-0xx
734-329	gray	25mm	/134-0xx	7 to 9	1	-	/124-0xx	/144-0xx
734-326	gray	35mm	/135-0xx	10 to 15	2	-	/125-0xx	/145-0xx

For colored female plugs, the item number suffix "xx" must be replaced by the blue "-006" and the green-yellow "-016" color suffix.

Dimensions of locking levers

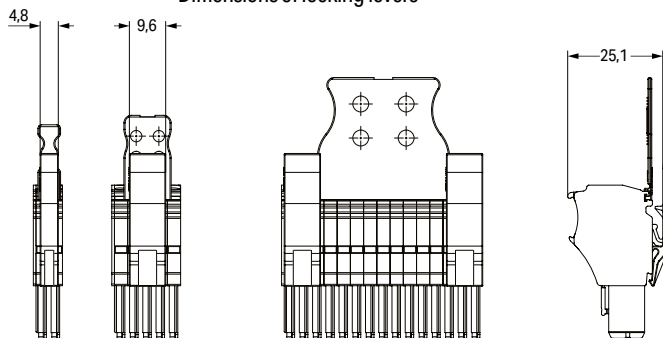

Description	Color	Item No.	Suffix No.
1-conductor female plug	gray	2020-102	none
2- to 15-pole	blue green-yellow	to 2020-115	/000-006 /000-016

Dimensions of strain relief plates

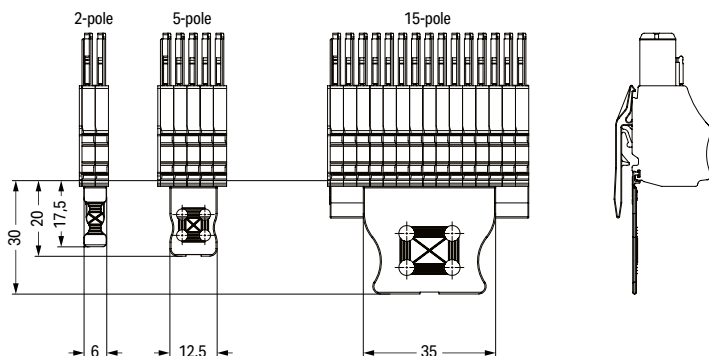

2-Conductor Female Plug X-COM®S-SYSTEM-MINI; with Lateral Locking Lever and Strain Relief Plate

1 (1.5) mm²; 2020 Series

Technical Data	
0.14 ... 1 (1.5) mm ² ①	24 ... 16 AWG
500 V / 6 kV / 3 ②	300 V, 15 A ③
I _N 13.5 A ④	300 V, 10 A ⑤
Module width: 3.5 mm / 0.138 inch	
9 ... 11 mm / 0.35 ... 0.43 inch	

Technical Data	
0.14 ... 1 (1.5) mm ² ①	24 ... 16 AWG
500 V / 6 kV / 3 ②	300 V, 15 A ③
I _N 13.5 A ④	300 V, 10 A ⑤
Module width: 3.5 mm / 0.138 inch	
9 ... 11 mm / 0.35 ... 0.43 inch	

Technical Data	
0.14 ... 1 (1.5) mm ² ①	24 ... 16 AWG
500 V / 6 kV / 3 ②	300 V, 15 A ③
I _N 13.5 A ④	300 V, 10 A ⑤
Module width: 3.5 mm / 0.138 inch	
9 ... 11 mm / 0.35 ... 0.43 inch	



2-conductor female plug; with locking lever; fits into carrier terminal blocks; codable; gray

Pole No.	Item No.	Pack. Unit
○ 2	2020-202/122-000	100
○ 3	2020-203/122-000	50
○ 4	2020-204/124-000	50
○ 5	2020-205/124-000	50
○ 6	2020-206/124-000	25
○ 7	2020-207/124-000	25
○ 8	2020-208/124-000	25
○ 9	2020-209/124-000	25
○ 10	2020-210/125-000	25
○ 11	2020-211/125-000	20
○ 12	2020-212/125-000	20
○ 13	2020-213/125-000	10
○ 14	2020-214/125-000	10
○ 15	2020-215/125-000	10

2-conductor female plug; with strain relief plate; fits into carrier terminal blocks; codable; gray

Pole No.	Item No.	Pack. Unit
○ 2	2020-202/132-000	100
○ 3	2020-203/132-000	50
○ 4	2020-204/133-000	50
○ 5	2020-205/133-000	50
○ 6	2020-206/133-000	25
○ 7	2020-207/134-000	25
○ 8	2020-208/134-000	25
○ 9	2020-209/134-000	25
○ 10	2020-210/135-000	25
○ 11	2020-211/135-000	20
○ 12	2020-212/135-000	20
○ 13	2020-213/135-000	10
○ 14	2020-214/135-000	10
○ 15	2020-215/135-000	10

2-conductor female plug; with strain relief plate and locking lever; fits into carrier terminal blocks; codable; gray

Pole No.	Item No.	Pack. Unit
○ 2	2020-202/142-000	100
○ 3	2020-203/142-000	50
○ 4	2020-204/143-000	50
○ 5	2020-205/143-000	50
○ 6	2020-206/143-000	25
○ 7	2020-207/144-000	25
○ 8	2020-208/144-000	25
○ 9	2020-209/144-000	25
○ 10	2020-210/145-000	25
○ 11	2020-211/145-000	20
○ 12	2020-212/145-000	20
○ 13	2020-213/145-000	10
○ 14	2020-214/145-000	10
○ 15	2020-215/145-000	10

Accessories; for female plugs

Appropriate marking systems: WMB/WMB Inline

Protective warning marker; with black high-voltage symbol; for 5 terminal blocks

	yellow	2000-115	100 (25)
---	--------	----------	----------

Carrier with 6 coding pins; for coding female plugs

	orange	2020-100	100 (25)
---	--------	----------	----------

WMB Inline; plain; 2,300 WMB markers (3.5 mm)/reel

	white	2009-113	1
---	-------	----------	---

WMB marking card; white; 10 strips with 10 markers/card; for 3.5 mm terminal block width

	plain	793-3501	5
--	-------	----------	---

❶ Conductor range: 0.14 ... 1.5 mm² "s+f-st";
 Push-in termination: 0.5 ... 1.5 mm² "s" and
 0.5 ... 0.75 mm² "insulated ferrules; 10 mm"
 Depending on the conductor characteristic, a conductor
 with a smaller cross section can also be inserted
 via push-in termination.

❷ 500 V = rated voltage
 6 kV = rated impulse voltage
 3 = pollution degree
 (see Section 15)

❸ Current-carrying capacity curves upon request

Note:
 According to EN 61984, pluggable connectors without
 a current interrupting capacity must not be mated or
 unmated when live or under load.
 Notice: An appropriate end plate must be applied to
 the carrier terminal blocks after each female plug.

Approvals and corresponding ratings,
 visit www.wago.com

Strain Relief Plate (SRP), Gray				Locking Lever (LL), Gray				SRP and LL, Gray
Assembled				Assembled				Assembled
SRP				Pole No.	Quantity	1-Way	2-Way	
Item No. Suffix				Item No. Suffix				Item No. Suffix
Item No.	Color	Width						
734-327	gray	6mm	/132-0xx	2 to 3	1	/122-0xx	-	/142-0xx
734-328	gray	12.5mm	/133-0xx	4 to 6	1	-	/124-0xx	/143-0xx
734-329	gray	25mm	/134-0xx	7 to 9	1	-	/124-0xx	/144-0xx
734-326	gray	35mm	/135-0xx	10 to 15	2	-	/125-0xx	/145-0xx

For colored female plugs, the item number suffix "xx" must be replaced by the blue "-006" and the green-yellow "-016" color suffix.

Dimensions of locking levers

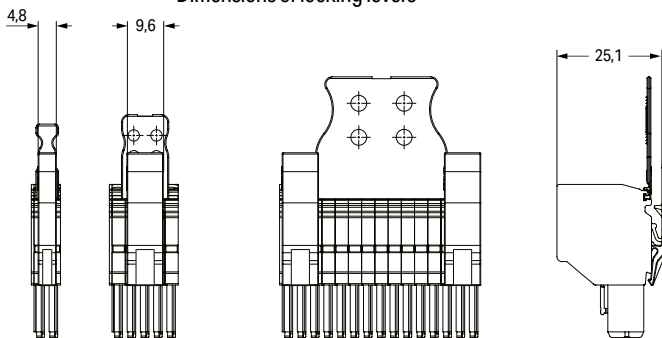

Description	Color	Item No.	Suffix No.
2-conductor female plug	gray	2020-202	none
2- to 15-pole	blue	to	/000-006
	green-yellow	2020-215	/000-016

Dimensions of strain relief plates

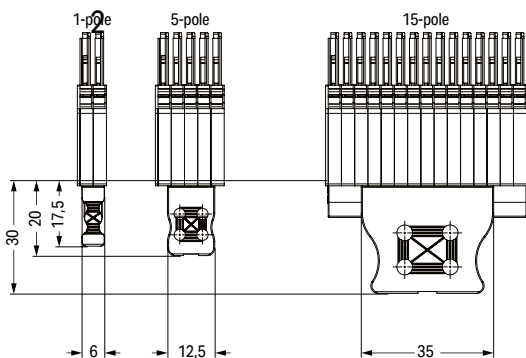

1-Conductor/1-Pin Carrier Terminal Block , 2-Conductor/1-Pin Carrier Terminal Block , 2-Conductor/2-Pin Carrier Terminal Block X-COM®S-SYSTEM; with Push-Button

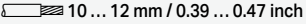

2.5 (4) mm²; 2222 Series

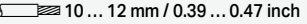

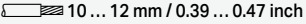
Technical Data	
0.25 ... 2.5 (4) mm ² ①	22 ... 12 AWG
690 V / 6 kV / 3 ②	
I _N 24 A (32 A) ③	
Terminal block width: 5.2 mm / 0.205 inch	
 10 ... 12 mm / 0.39 ... 0.47 inch	

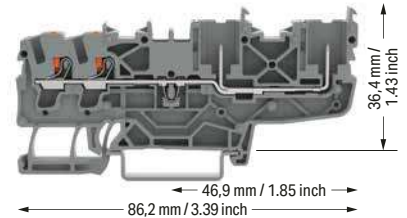
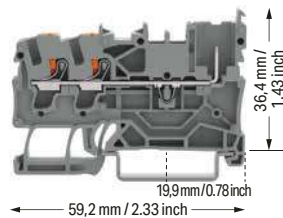
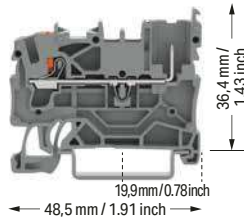

Technical Data	
0.25 ... 2.5 (4) mm ² ①	22 ... 12 AWG
690 V / 6 kV / 3 ②	
I _N 24 A (32 A) ③	
Terminal block width: 5.2 mm / 0.205 inch	
 10 ... 12 mm / 0.39 ... 0.47 inch	

Technical Data	
0.25 ... 2.5 (4) mm ² ①	22 ... 12 AWG
690 V / 6 kV / 3 ②	
I _N 24 A (28 A) ③	
Terminal block width: 5.2 mm / 0.205 inch	
 10 ... 12 mm / 0.39 ... 0.47 inch	





1-conductor/1-pin carrier terminal block; with push-button		
Color	Item No.	Pack. Unit
 gray	2222-1201	100
 blue	2222-1204	100
 orange	2222-1202	100



2-conductor/1-pin carrier terminal block; with push-button		
Color	Item No.	Pack. Unit
 gray	2222-1301	100
 blue	2222-1304	100
 orange	2222-1302	100



2-conductor/2-pin carrier terminal block; with push-button		
Color	Item No.	Pack. Unit
 gray	2222-1401	50
 blue	2222-1404	50
 orange	2222-1402	50



1-conductor/1-pin ground carrier terminal block; with push-button		
Color	Item No.	Pack. Unit
 green-yellow	2222-1207	100

2-conductor/1-pin ground carrier terminal block; with push-button		
Color	Item No.	Pack. Unit
 green-yellow	2222-1307	100

2-conductor/2-pin ground carrier terminal block; with push-button		
Color	Item No.	Pack. Unit
 green-yellow	2222-1407	50

Accessories; item-specific			
End and intermediate plate; 1 mm thick			
	orange	2022-1292	100 (25)
	gray	2022-1291	100 (25)

Accessories; item-specific			
End and intermediate plate; 1 mm thick			
	orange	2022-1392	100 (25)
	gray	2022-1391	100 (25)



Accessories; item-specific			
End and intermediate plate; 1 mm thick			
	orange	2022-1492	100 (25)
	gray	2022-1491	100 (25)

Accessories; 2222 Series

Appropriate marking systems: WMB/WMB Inline/marketing strips



Insulation stop; 5 pcs/strip; 0.25 ... 0.5 mm ²			
	light gray	2002-171	200 (25)









Delta jumper; insulated; I _N = I _N terminal block; light gray			
	1-2 3-4 5-6	2002-406/020-000	25

Continuous jumper; insulated; I _N 25 A, light gray			
	3-way	2002-413	25
	5-way	2002-415	25

Insulation stop; 5 pcs/strip; 0.75 ... 1 mm ²			
	dark gray	2002-172	200 (25)

Star point jumper; insulated; I _N = I _N terminal block; light gray			
	1-3-5	2002-405/011-000	25









Push-in type wire jumper; insulated; 1.5 mm ² conductor cross-section; I _N 18 A			
	L = 60 mm	2009-412	100 (10)
	L = 110 mm	2009-414	100 (10)
	L = 250 mm	2009-416	100 (10)

Push-in type jumper bar; insulated; I _N 25 A; light gray			
	2-way	2002-402	25
	3-way	2002-403	25
	4-way	2002-404	25
	5-way	2002-405	25
	6-way	2002-406	25
	7-way	2002-407	25
	8-way	2002-408	25
	9-way	2002-409	25
	10-way	2002-410	25

Staggered jumper; insulated; I _N 25 A; light gray			
	2-way	2002-472	25
	3-way	2002-473	25
	4-way	2002-474	25
	5-way	2002-475	25
	6-way	2002-476	25
	7-way	2002-477	25
	8-way	2002-478	25
	9-way	2002-479	25
	10-way	2002-480	25
	11-way	2002-481	25
	12-way	2002-482	25

Carrier with 6 coding pins; for coding female plugs			
	orange	2022-100	100 (25)

Test pin; 1 mm Ø			
		859-500	1

Push-in type jumper bar; insulated; I _N 25 A; light gray			
	2-way	2002-402	25
	3-way	2002-403	25
	4-way	2002-404	25
	5-way	2002-405	25
	6-way	2002-406	25
	7-way	2002-407	25
	8-way	2002-408	25
	9-way	2002-409	25
	10-way	2002-410	25

Continuous jumper; insulated; I _N 25 A; light gray			
	1-2	2002-400	25

1-conductor female plug			
	gray	2022-101	200

WMB Inline; plain; 1,500 WMB markers (5 mm)/reel; stretchable 5 ... 5.2 mm			
	white	2009-115	1

WMB marker card; white; 10 strips with 10 markers/card; stretchable 5 ... 5.2 mm			
	plain	793-5501	5

❶ Conductor range: 0.25 ... 4 mm² "s+f-st"
Push-in termination: 1 ... 4 mm² "s" and 1 ... 2.5 mm²
"insulated ferrules, 12 mm"
Depending on the conductor characteristic, a conductor with a smaller cross-section can also be inserted via push-in termination.

❷ 690 V = rated voltage
6 kV = rated impulse voltage
3 = pollution degree
(see Section 15)

❸ Current-carrying capacity curves upon request

Note:

When used as intended, female plugs must not be connected/disconnected when live or under load.

Please observe the application notes:
Jumpers, from page 182
Marking, from page 684

Approvals and corresponding ratings,
visit www.wago.com

1-Conductor/1-Pin Carrier Terminal Block, 2-Conductor/1-Pin Carrier Terminal Block, 2-Conductor/2-Pin Carrier Terminal Block X-COM®S-SYSTEM

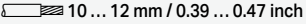

2.5 (4) mm²; 2022 Series

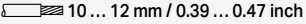

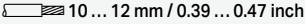
Technical Data	
0.25 ... 2.5 (4) mm ² ①	22 ... 12 AWG
690 V / 6 kV / 3 ②	600 V, 20 A ③
I _N 24 A (32 A) ④	600 V, 20 A ⑤
Terminal block width: 5.2 mm / 0.205 inch	
 10 ... 12 mm / 0.39 ... 0.47 inch	

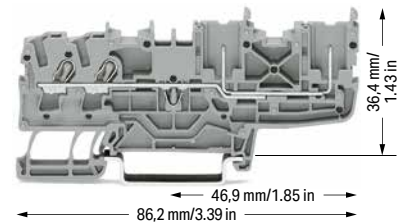
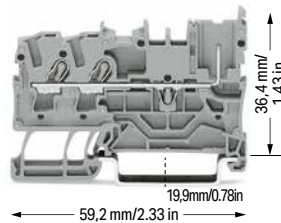
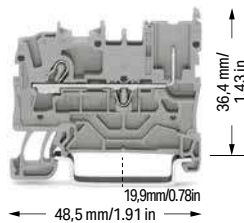

Technical Data	
0.25 ... 2.5 (4) mm ² ①	22 ... 12 AWG
690 V / 6 kV / 3 ②	600 V, 20 A ③
I _N 24 A (32 A) ④	600 V, 20 A ⑤
Terminal block width: 5.2 mm / 0.205 inch	
 10 ... 12 mm / 0.39 ... 0.47 inch	

Technical Data	
0.25 ... 2.5 (4) mm ² ①	22 ... 12 AWG
690 V / 6 kV / 3 ②	600 V, 20 A ③
I _N 24 A (28 A) ④	600 V, 20 A ⑤
Terminal block width: 5.2 mm / 0.205 inch	
 10 ... 12 mm / 0.39 ... 0.47 inch	





1-conductor/1-pin carrier terminal block		
Color	Item No.	Pack. Unit
 gray	2022-1201	100
 blue	2022-1204	100
 orange	2022-1202	100



2-conductor/1-pin carrier terminal block		
Color	Item No.	Pack. Unit
 gray	2022-1301	100
 blue	2022-1304	100
 orange	2022-1302	100



2-conductor/2-pin carrier terminal block		
Color	Item No.	Pack. Unit
 gray	2022-1401	50
 blue	2022-1404	50
 orange	2022-1402	50



1-conductor/1-pin ground carrier terminal block		
 green-yellow	2022-1207	100

2-conductor/1-pin ground carrier terminal block		
 green-yellow	2022-1307	100

2-conductor/2-pin ground carrier terminal block		
 green-yellow	2022-1407	50

Accessories; item-specific			
End and intermediate plate; 1 mm thick			
	orange	2022-1292	100 (25)
	gray	2022-1291	100 (25)

Accessories; item-specific			
End and intermediate plate; 1 mm thick			
	orange	2022-1392	100 (25)
	gray	2022-1391	100 (25)

Accessories; item-specific			
End and intermediate plate; 1 mm thick			
	orange	2022-1492	100 (25)
	gray	2022-1491	100 (25)

Accessories; 2022 Series

Appropriate marking systems: WMB/WMB Inline/Marking strips

Insulation stop; 5 pcs/strip; 0.25 ... 0.5 mm ²			
	light gray	2002-171	200 (25)

Delta jumper; insulated; I _N = I _N terminal block; light gray			
	1-2 3-4 5-6	2002-406/020-000	25

Push-in type wire jumper; insulated; 1.5 mm ² conductor cross-section; I _N 18 A			
	L = 60 mm	2009-412	100 (10)
	L = 110 mm	2009-414	100 (10)
	L = 250 mm	2009-416	100 (10)

Insulation stop; 5 pcs/strip; 0.75 ... 1 mm ²			
	dark gray	2002-172	200 (25)

Star point jumper; insulated; I _N = I _N terminal block; light gray			
	1-3-5	2002-405/011-000	25

Carrier with 6 coding pins; for coding female plugs			
	orange	2022-100	100 (25)

Protective warning marker; with black high-voltage symbol; for 5 terminal blocks			
	yellow	2002-115	100 (25)

Staggered jumper; insulated; I _N 25 A; light gray			
	2-way	2002-472	25
	3-way	2002-473	25
	4-way	2002-474	25
	5-way	2002-475	25
	6-way	2002-476	25
	7-way	2002-477	25
	8-way	2002-478	25
	9-way	2002-479	25
	10-way	2002-480	25
	11-way	2002-481	25
	12-way	2002-482	25

Test pin; 1 mm Ø			
		859-500	1

Push-in type jumper bar; insulated; I _N 25 A; light gray			
	2-way	2002-402	25
	3-way	2002-403	25
	4-way	2002-404	25
	5-way	2002-405	25
	6-way	2002-406	25
	7-way	2002-407	25
	8-way	2002-408	25
	9-way	2002-409	25
	10-way	2002-410	25

Continuous jumper; insulated; I _N 25 A; light gray			
	2-way	2002-400	25

1-conductor female plug			
	gray	2022-101	200

Push-in type jumper bar; insulated; I _N 25 A; light gray			
	1 to 3	2002-433	25
	1 to 4	2002-434	25
	1 to 5	2002-435	25
	1 to 6	2002-436	25
	1 to 7	2002-437	25
	1 to 8	2002-438	25
	1 to 9	2002-439	25
	1 to 10	2002-440	25

Continuous jumper; insulated; I _N 25 A; light gray			
	1 to 3	2002-423	25
	1 to 4	2002-424	25

Marking strip; plain; 11 mm wide; 50 m reel			
	white	2009-110	1

WMB Inline; plain; 1,500 WMB markers (5 mm)/reel; 5 ... 5.2 mm stretchable			
	white	2009-115	1

WMB marking card; white; 10 strips with 10 markers/card; 5 ... 5.2 mm stretchable			
	plain	793-5501	5

❶ Conductor range: 0.25 ... 4 mm² "s+f-st";
Push-in termination: 1 ... 4 mm² "s" and 1 ... 2.5 mm²
"insulated ferrules, 12 mm"
Depending on the conductor characteristic, a conductor with a smaller cross section can also be inserted via push-in termination.

❷ 690 V = rated voltage
6 kV = rated impulse voltage
3 = pollution degree
(see Section 15)

❸ Current-carrying capacity curves upon request

Note:

When used as intended, female plugs must not be connected/disconnected when live or under load.

Please observe the application notes:
Jumpers, from page 182
Marking, from page 684

Approvals and corresponding ratings,
visit www.wago.com

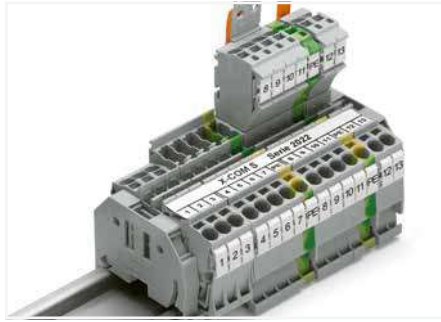

2022 Series X-COM®S-SYSTEM Carrier Terminal Blocks combined with 2002 Series Through Terminal Blocks

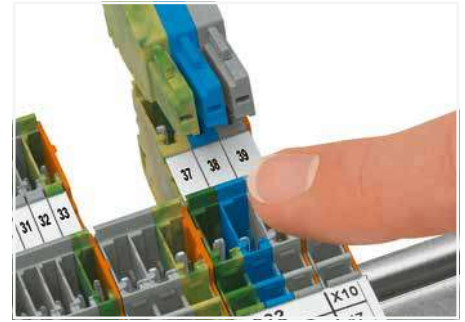

Carrier terminal blocks and female plugs are touch-proof.

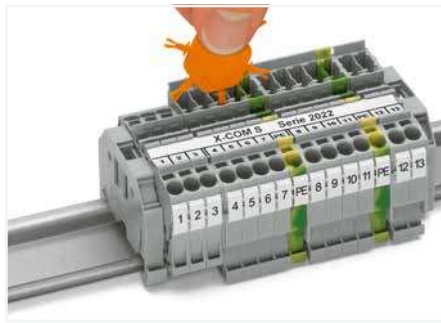

Insert coding pin into the corresponding slot and twist it off.



2-Pin Carrier Terminal Block, 4-Pin Carrier Terminal Block X-COM®S-SYSTEM 2022 Series

Technical Data

690 V / 6 kV / 3 ①

I_N 24 A (28 A) ②

Terminal block width: 5.2 mm / 0.205 inch

Technical Data

690 V / 6 kV / 3 ①

I_N 24 A (27 A) ②

Terminal block width: 5.2 mm / 0.205 inch

- ① 690 V = rated voltage
6 kV = rated impulse voltage
3 = pollution degree
(see Section 15)

- ② Current-carrying capacity curves upon request

Note:

When used as intended, female plugs must not be connected/disconnected when live or under load.

Please observe the application notes:
Jumpers, from page 182
Marking, from page 684

Approvals and corresponding ratings, visit www.wago.com

Accessories; 2022 Series

Appropriate marking systems:
WMB/WMB Inline/Marking strips

Marking strip; plain; 11 mm wide; 50 m reel

white 2009-110 1

WMB Inline, plain; 1,500 WMB markers (5 mm)/reel; 5 ... 5.2 mm stretchable

white 2009-115 1

WMB marking card; white; 10 strips with 10 markers/card; 5 ... 5.2 mm stretchable

plain 793-5501 5

2

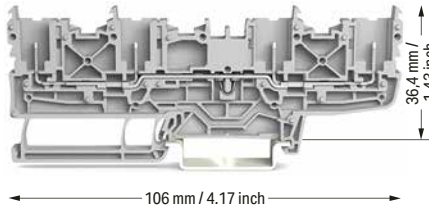
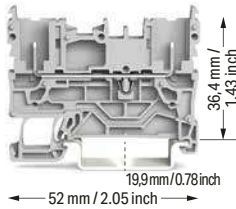

2-pin carrier terminal block

Color	Item No.	Pack. Unit
gray	2022-1601	50
blue	2022-1604	50

4-pin carrier terminal block

Color	Item No.	Pack. Unit
gray	2022-1801	50
blue	2022-1804	50

2-pin ground carrier terminal block

green-yellow	2022-1607	50
--------------	-----------	----

4-pin ground carrier terminal block

green-yellow	2022-1807	50
--------------	-----------	----

Item-Specific Accessories

End plate; 1 mm thick

orange	2022-1692	100 (25)
gray	2022-1691	100 (25)

Item-Specific Accessories

End plate; 1 mm thick

orange	2022-1892	100 (25)
gray	2022-1891	100 (25)

Accessories; 2022 Series

Appropriate marking systems: WMB/WMB Inline/Marking strips

Push-in type jumper bar; insulated; I_N 25 A; light gray

2-way	2002-402	25
3-way	2002-403	25
4-way	2002-404	25
5-way	2002-405	25
6-way	2002-406	25
7-way	2002-407	25
8-way	2002-408	25
9-way	2002-409	25
10-way	2002-410	25

Staggered jumper; insulated; I_N 25 A; light gray

2-way	2002-472	25
3-way	2002-473	25
4-way	2002-474	25
5-way	2002-475	25
6-way	2002-476	25
7-way	2002-477	25
8-way	2002-478	25
9-way	2002-479	25
10-way	2002-480	25
11-way	2002-481	25
12-way	2002-482	25

Push-in type jumper bar; insulated; I_N 25 A; light gray

1 to 3	2002-433	25
1 to 4	2002-434	25
1 to 5	2002-435	25
1 to 6	2002-436	25
1 to 7	2002-437	25
1 to 8	2002-438	25
1 to 9	2002-439	25
1 to 10	2002-440	25

Continuous jumper; insulated; I_N 25 A; light gray

1 to 3	2002-423	25
1 to 4	2002-424	25

Delta jumper; insulated; I_N = I_N terminal block; light gray

1-2 3-4 5-6	2002-406/020-000	25
-------------	------------------	----

Continuous jumper; insulated; I_N 25 A; light gray

3-way	2002-413	25
5-way	2002-415	25

Star point jumper; insulated; I_N = I_N terminal block; light gray

1-3-5	2002-405/011-000	25
-------	------------------	----

Push-in type wire jumper; insulated; 1.5 mm² conductor cross-section; I_N 18 A

L = 60 mm	2009-412	100 (10)
L = 110 mm	2009-414	100 (10)
L = 250 mm	2009-416	100 (10)

Continuous jumper; insulated; I_N 25 A; light gray

2-way	2002-400	25
-------	----------	----

Carrier with 6 coding pins; for coding female plugs

orange	2022-100	100 (25)
--------	----------	----------

1-conductor female plug

gray	2022-101	200
------	----------	-----

Carrier Terminal Blocks and 1-Conductor Female Plugs X-COM®S-SYSTEM

Types of Assembly

2

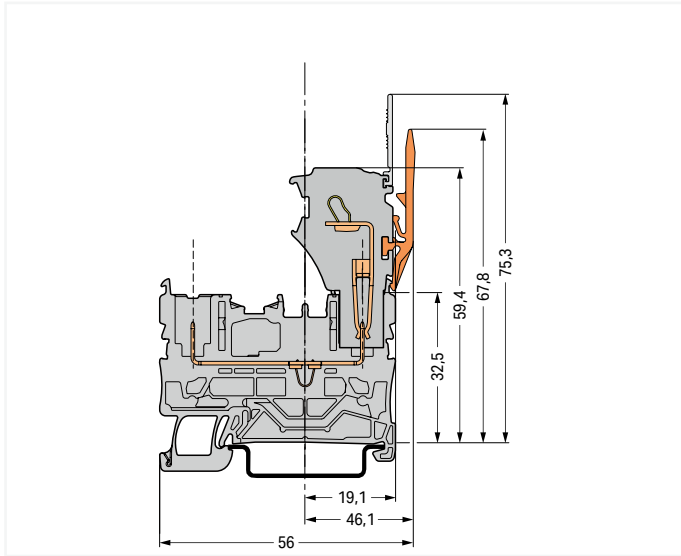

Carrier terminal block

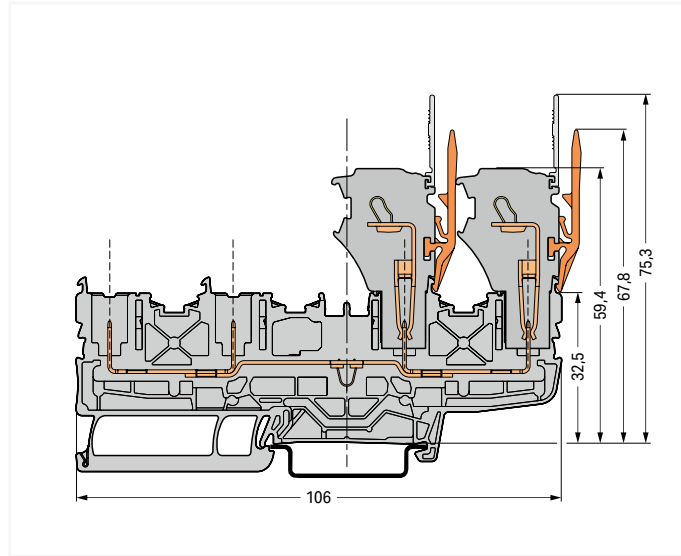

Carrier terminal block

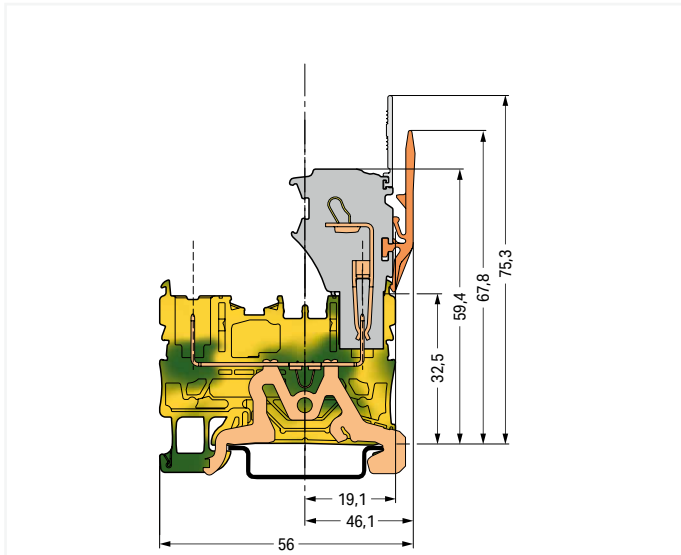

Ground carrier terminal block

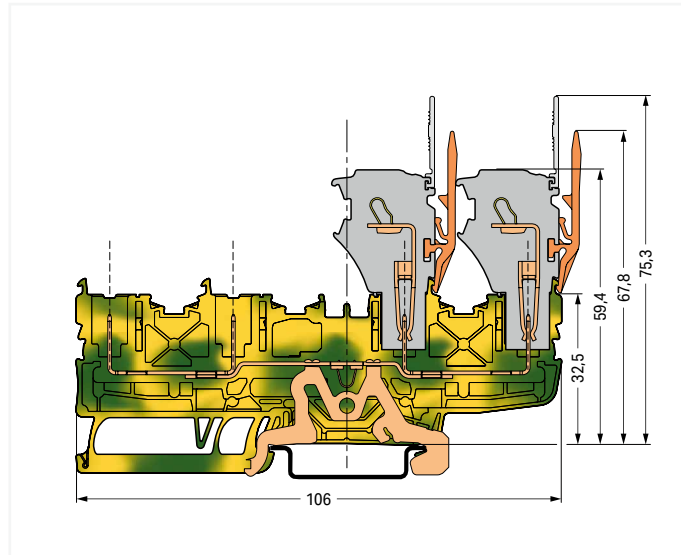

Ground carrier terminal block

1-Conductor/1-Pin Double-Deck Carrier Terminal Block X-COM®S-SYSTEM

2.5 (4) mm²; 2022 Series

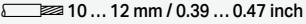
Technical Data	
0.25 ... 2.5 (4) mm ² ①	22 ... 12 AWG
690 V / 6 kV / 3 ②	600 V, 20 A ③
I _N 24 A (28 A) ④	600 V, 20 A ⑤
Terminal block width: 5.2 mm / 0.205 inch	
 10 ... 12 mm / 0.39 ... 0.47 inch	

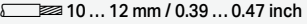
Technical Data	
0.25 ... 2.5 (4) mm ² ①	22 ... 12 AWG
690 V / 6 kV / 3 ②	600 V, 20 A ③
I _N 24 A (28 A) ④	600 V, 20 A ⑤
Terminal block width: 5.2 mm / 0.205 inch	
 10 ... 12 mm / 0.39 ... 0.47 inch	

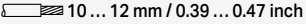
Technical Data	
0.25 ... 2.5 (4) mm ² ①	22 ... 12 AWG
690 V / 6 kV / 3 ②	600 V, 20 A ③
I _N 24 A (28 A) ④	600 V, 20 A ⑤
Terminal block width: 5.2 mm / 0.205 inch	
 10 ... 12 mm / 0.39 ... 0.47 inch	

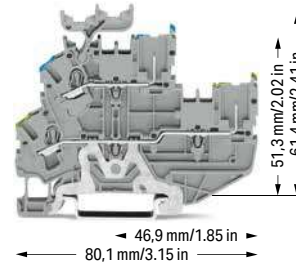
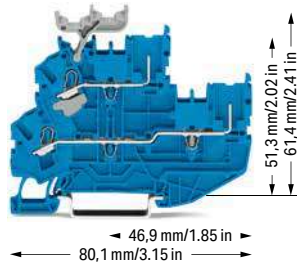
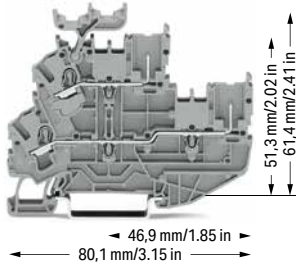

1-conductor/1-pin double-deck carrier terminal block; through/through terminal block; with marker carrier; gray

	Item No.	Pack. Unit
○ L/L	2022-2231	50
○ N/L	2022-2232	50
○ L/N	2022-2233	50

1-conductor/1-pin double-deck carrier terminal block; through/through terminal block; with marker carrier; blue

	Item No.	Pack. Unit
● N/N	2022-2234	50

1-conductor/1-pin double-deck carrier terminal block; ground conductor/through terminal block; with marker carrier; gray

	Item No.	Pack. Unit
○ PE/N	2022-2247	50
○ PE/L	2022-2257	50

1-conductor/1-pin double-deck carrier terminal block; through/through terminal block; without marker carrier; gray

○ L/L	2022-2201	50
○ N/L	2022-2202	50
○ L/N	2022-2203	50

1-conductor/1-pin double-deck carrier terminal block; through/through terminal block; without marker carrier; blue

● N/N	2022-2204	50
-------	-----------	----

1-conductor/1-pin double-deck carrier terminal block; ground conductor/through terminal block; without marker carrier; gray

○ PE/N	2022-2217	50
○ PE/L	2022-2227	50

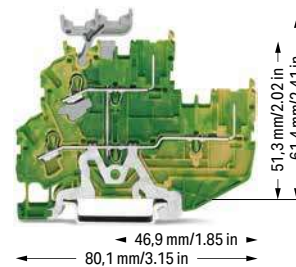
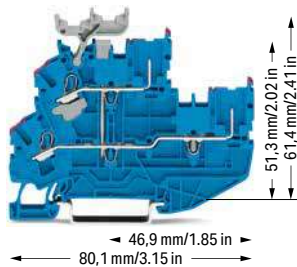
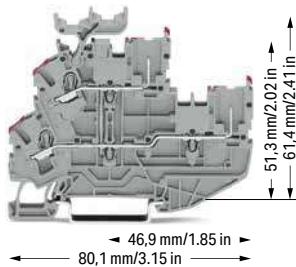

2-conductor/2-pin double-deck carrier terminal block; 2-conductor/2-pin through terminal block; with marker carrier, internally commoned; violet conductor entry; gray

	Item No.	Pack. Unit
○ L	2022-2238	50

2-conductor/2-pin double-deck carrier terminal block; 2-conductor/2-pin through terminal block; with marker carrier, internally commoned; violet conductor entry; blue

● N	2022-2239	50
-----	-----------	----

2-conductor/2-pin double-deck carrier block; 2-conductor/2-pin ground conductor block; with marker carrier, internally commoned; green-yellow

● PE	2022-2237	50
------	-----------	----

2-conductor/2-pin double-deck carrier terminal block; 2-conductor/2-pin through terminal block; without marker carrier, internally commoned; violet conductor entry; gray

○ L	2022-2208	50
-----	-----------	----

2-conductor/2-pin double-deck carrier terminal block; 2-conductor/2-pin through terminal block; without marker carrier, internally commoned; violet conductor entry; blue

● N	2022-2209	50
-----	-----------	----

2-conductor/2-pin double-deck carrier block; 2-conductor/2-pin ground conductor block; without marker carrier, internally commoned; green-yellow

● PE	2022-2207	50
------	-----------	----

❶ Conductor range: 0.25 ... 4 mm² "s+f-st";
Push-in termination: 1 ... 4 mm² "s" and 1 ... 2.5 mm²
"insulated ferrules, 12 mm"
Depending on the conductor characteristic, a conductor
with a smaller cross section can also be inserted
via push-in termination.

❷ 690 V = rated voltage
6 kV = rated impulse voltage
3 = pollution degree
(see Section 15)

❸ Current-carrying capacity curves upon request

Note:

When used as intended, female plugs must not be
connected/disconnected when live or under load.

Please observe the application notes:
Jumpers, from page 182
Marking, from page 684

Approvals and corresponding ratings,
visit www.wago.com

Accessories; 2022 Series

Appropriate marking systems:
WMB/WMB Inline/Marking strips

End and intermediate plate; 1 mm thick

	orange	2022-2292	100 (25)
	gray	2022-2291	100 (25)

Insulation stop; 5 pcs/strip; 0.25 ... 0.5 mm²

	light gray	2002-171	200 (25)
---	------------	----------	----------

Insulation stop; 5 pcs/strip; 0.75 ... 1 mm²

	dark gray	2002-172	200 (25)
---	-----------	----------	----------

**Protective warning marker; with black high-voltage
symbol; for 5 terminal blocks**

	yellow	2002-115	100 (25)
---	--------	----------	----------

Push-in type jumper bar; insulated; I_N 25 A; light gray

	2-way	2002-402	25
	3-way	2002-403	25
	4-way	2002-404	25
	5-way	2002-405	25
	6-way	2002-406	25
	7-way	2002-407	25
	8-way	2002-408	25
	9-way	2002-409	25
	10-way	2002-410	25

Push-in type jumper bar; insulated; I_N 25 A; light gray

	1 to 3	2002-433	25
	1 to 4	2002-434	25
	1 to 5	2002-435	25
	1 to 6	2002-436	25
	1 to 7	2002-437	25
	1 to 8	2002-438	25
	1 to 9	2002-439	25
	1 to 10	2002-440	25

Continuous jumper; insulated; I_N 25 A; light gray

	2-way	2002-400	25
---	-------	----------	----

Continuous jumper; insulated; I_N 25 A; light gray

	1 to 3	2002-423	25
	1 to 4	2002-424	25

Accessories; 2022 Series

Appropriate marking systems:
WMB/WMB Inline/Marking strips

Continuous jumper; insulated; I_N 25 A; light gray

	3-way	2002-413	25
	5-way	2002-415	25

Double-deck vertical jumper; insulated; I_N 24 A

	light gray	2002-492	100 (25)
	orange	2002-492/000-012	100 (25)

Carrier with 6 coding pins; for coding female plugs

	orange	2022-100	100 (25)
---	--------	----------	----------

Test pin; 1 mm Ø

		859-500	1
---	--	---------	---

Test plug adapter; for 4 mm Ø test plug

	gray	2009-174	100 (25)
---	------	----------	----------

Testing tap; for max. 2.5 mm²

	gray	2009-182	100 (25)
---	------	----------	----------

1-conductor female plug

	gray	2022-101	200
---	------	----------	-----

Marking strip; plain; 11 mm wide; 50 m reel

	white	2009-110	1
---	-------	----------	---

**WMB Inline; plain; 1,500 WMB markers (5 mm)/reel;
5 ... 5.2 mm stretchable**

	white	2009-115	1
---	-------	----------	---

**WMB marking card; white; 10 strips with 10 markers/card;
5 ... 5.2 mm stretchable**

	plain	793-5501	5
---	-------	----------	---

Double-deck marker carrier; pivoting

	gray	2002-121	50 (25)
---	------	----------	---------



Size comparison:
Double-deck carrier terminal blocks with 3.5 mm and
5.2 mm terminal block widths

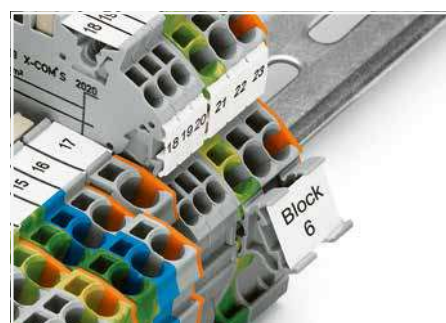

Marker carrier (2009-198)

1-Conductor Female Plug X-COM®S-SYSTEM

2.5 (4) mm²; 2022 Series

Technical Data

0.25 ... 2.5 (4) mm ² ❶	22 ... 12 AWG
690 V / 6 kV / 3 ❷	600 V, 20 A ❸
I _N 24 A (32 A) ❸	600 V, 20 A ❸
Module width: 5.2 mm / 0.205 inch	
10 ... 12 mm / 0.39 ... 0.47 inch	



Dimensions (in mm):

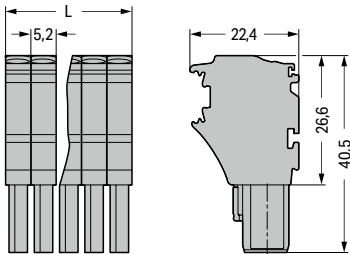

L = pole no. x module width

1-conductor female plug; fits into carrier terminal blocks; codable; gray
According to EN 61984, pluggable connectors without a current interrupting capacity must not be mated or unmated when live or under load.

Pole No.	Item No.	Pack. Unit
1	2022-101	200
2	2022-102	200
3	2022-103	100
4	2022-104	100
5	2022-105	50
6	2022-106	50
7	2022-107	50
8	2022-108	50
9	2022-109	50
10	2022-110	25
11	2022-111	25
12	2022-112	25
13	2022-113	25
14	2022-114	25
15	2022-115	25

Accessories; for female plugs

Appropriate marking systems:
WMB/WMB Inline/Marking strips

Insulation stop; 5 pcs/strip; 0.25 ... 0.5 mm²

light gray	2002-171	200 (25)
------------	----------	----------

Insulation stop; 5 pcs/strip; 0.75 ... 1 mm²

dark gray	2002-172	200 (25)
-----------	----------	----------

- Conductor range: 0.25 ... 4 mm² "s+f-st"; Push-in termination: 1 ... 4 mm² "s" and 1 ... 2.5 mm² "insulated ferrules, 12 mm"
Depending on the conductor characteristic, a conductor with a smaller cross section can also be inserted via push-in termination.
- 690 V = rated voltage
6 kV = rated impulse voltage
3 = pollution degree (see Section 15)
- Current-carrying capacity curves upon request

Item no. suffixes

blue	.../000-006
orange	.../000-012
green-yellow	.../000-016

Approvals and corresponding ratings, visit www.wago.com

Accessories; for female plugs

Appropriate marking systems:
WMB/WMB Inline/Marking strips

Protective warning marker; with black high-voltage symbol; for 5 terminal blocks

yellow	2002-115	100 (25)
--------	----------	----------

Locking lever; 4.8 mm wide

orange	2022-142	100 (25)
gray	2022-141	100 (25)

Locking lever; 9.6 mm wide

orange	2022-152	100 (25)
gray	2022-151	100 (25)

Carrier with 6 coding pins; for coding female plugs

orange	2022-100	100 (25)
--------	----------	----------

Strain relief plate; gray

35 mm wide	734-326	100 (25)
6 mm wide	734-327	100 (25)
12.5 mm wide	734-328	100 (25)
25 mm wide	734-329	100 (25)
55 mm wide	734-430	50 (25)
75 mm wide	734-431	50 (25)

Marking strip; plain; 11 mm wide; 50 m reel

white	2009-110	1
-------	----------	---

WMB Inline, plain; 1,500 WMB markers (5 mm)/reel; 5 ... 5.2 mm stretchable

white	2009-115	1
-------	----------	---

WMB marking card; white; 10 strips with 10 markers/card; 5 ... 5.2 mm stretchable

plain	793-5501	5
-------	----------	---



Coding a female plug: remove coding finger using a suitable tool.

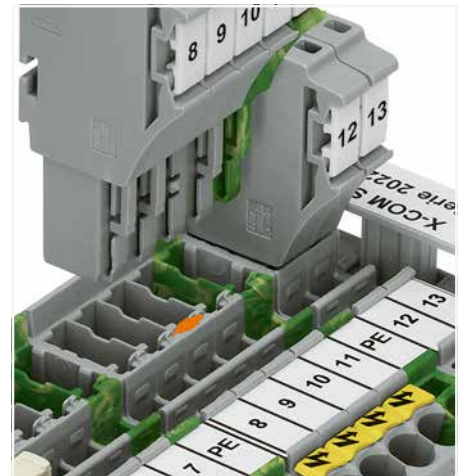

Insert a coding pin (2022-100) into the corresponding location of the carrier terminal block.

Carrier Terminal Blocks and 1-Conductor Female Plugs X-COM®S-SYSTEM

Types of Assembly

2

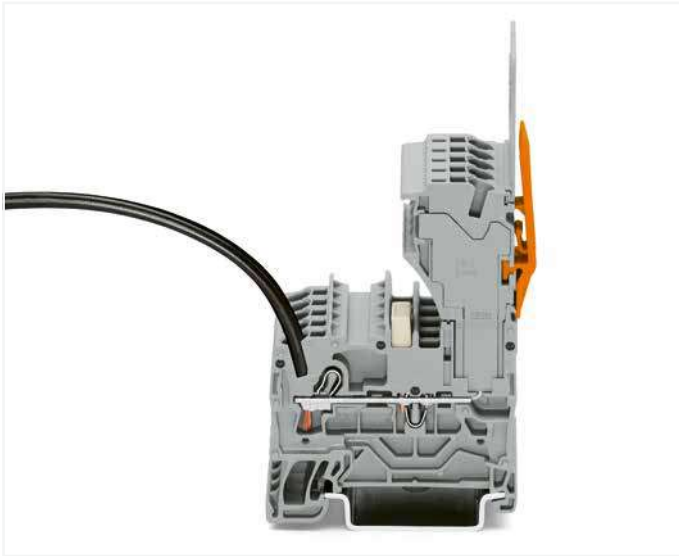

1-conductor female plug
Carrier terminal blocks can be commoned via 2002 Series Push-In Type Jumper Bars and tested via 859-500 Test Pin.

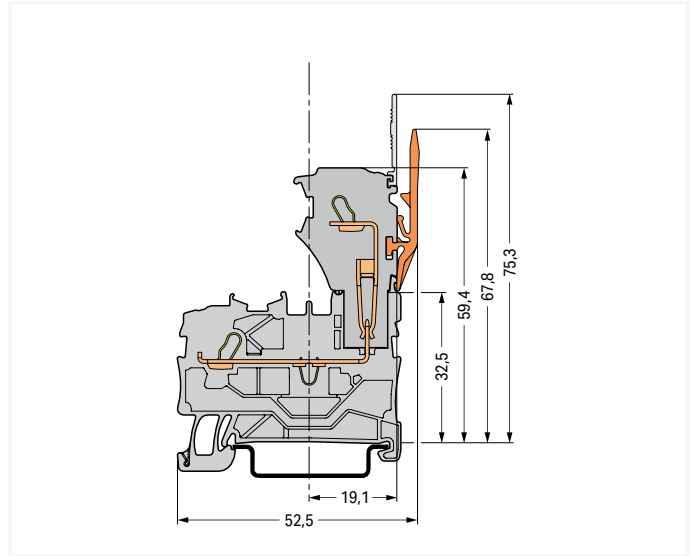

Carrier terminal block

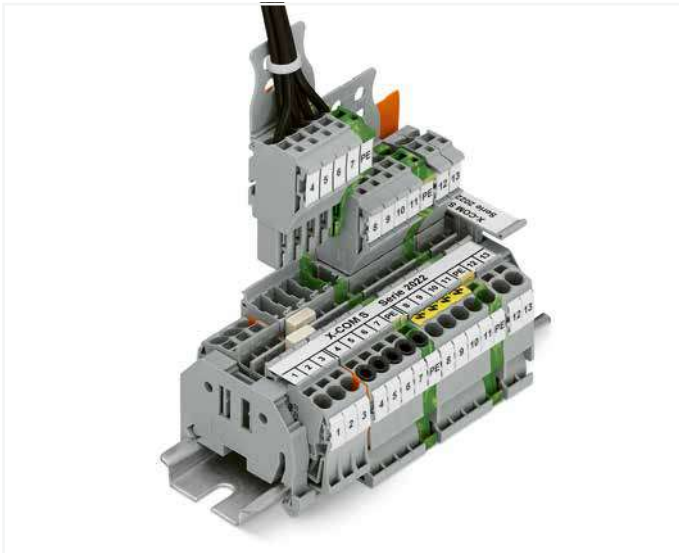

X-COM®S-SYSTEM terminal block assembly

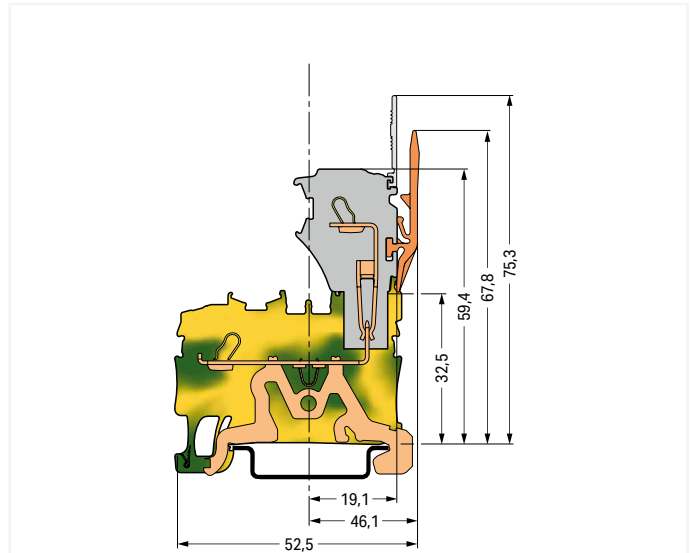

Ground carrier terminal block

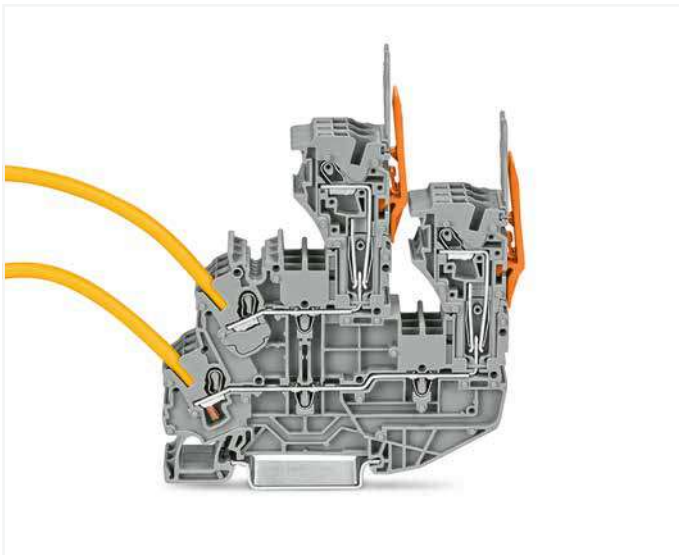

1-conductor female plug
Double-deck carrier terminal blocks can be commoned via 2002 Series Push-In Type Jumper Bars and tested via 859-500 Test Pin.

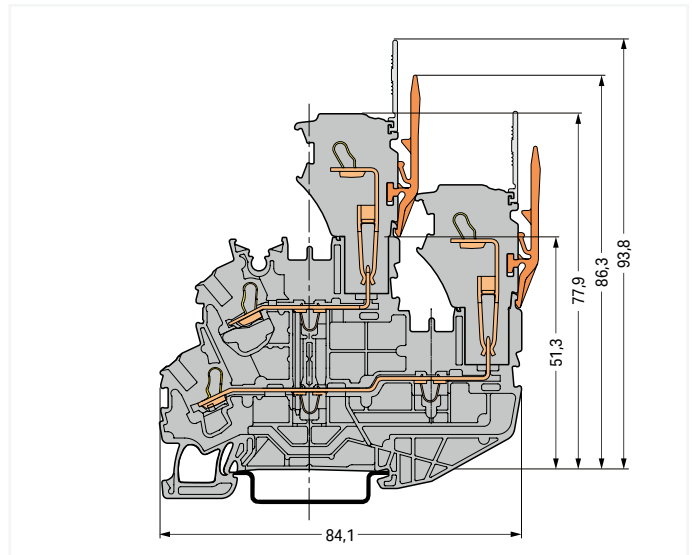

Double-deck carrier terminal block

Female Plug for Self-Assembly X-COM®S-SYSTEM



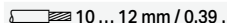

2.5 (4) mm²; 2022 Series

Technical Data

0.25 ... 2.5 (4) mm ² ①	22 ... 12 AWG
690 V / 6 kV / 3 ②	600 V, 20 A ③
I _N 24 A (32 A) ③	600 V, 20 A ③
Terminal block width: 5.2 mm / 0.205 inch	
 10 ... 12 mm / 0.39 ... 0.47 inch	



1-conductor end module; codable

Color	Item No.	Pack. Unit
 gray	2022-181	250
 blue	2022-184	250
 orange	2022-182	250
 green-yellow	2022-187	250

1-conductor center module; codable

 gray	2022-171	250
 blue	2022-174	250
 orange	2022-172	250
 green-yellow	2022-177	250

1-conductor base module; with integrated end plate; codable

 gray	2022-161	250
 blue	2022-164	250
 orange	2022-162	250
 green-yellow	2022-167	250

Accessories; for female plugs

Appropriate marking systems:
WMB/WMB Inline/Marking strips

Insulation stop; 5 pcs/strip; 0.25 ... 0.5 mm²

 light gray	2002-171	200 (25)
--	----------	----------

Insulation stop; 5 pcs/strip; 0.75 ... 1 mm²

 dark gray	2002-172	200 (25)
---	----------	----------

Protective warning marker; with black high-voltage symbol; for 5 terminal blocks

 yellow	2002-115	100 (25)
--	----------	----------

Locking lever; 4.8 mm wide

 orange	2022-142	100 (25)
gray	2022-141	100 (25)

Locking lever; 9.6 mm wide

 orange	2022-152	100 (25)
gray	2022-151	100 (25)

Carrier with 6 coding pins; for coding female plugs

 orange	2022-100	100 (25)
--	----------	----------

① Conductor range: 0.25 ... 4 mm² "s+f-st";
Push-in termination: 1 ... 4 mm² "s" and 1 ... 2.5 mm² "insulated ferrules, 12 mm"
Depending on the conductor characteristic, a conductor with a smaller cross section can also be inserted via push-in termination.

② 690 V = rated voltage
6 kV = rated impulse voltage
3 = pollution degree
(see Section 15)

③ Current-carrying capacity curves upon request

Note:

According to EN 61984, pluggable connectors without a current interrupting capacity must not be mated or unmated when live or under load.

Approvals and corresponding ratings,
visit www.wago.com

Accessories; for female plugs

Appropriate marking systems:
WMB/WMB Inline/Marking strips

Strain relief plate; gray

 35 mm wide	734-326	100 (25)
6 mm wide	734-327	100 (25)
12.5 mm wide	734-328	100 (25)
25 mm wide	734-329	100 (25)
55 mm wide	734-430	50 (25)
75 mm wide	734-431	50 (25)

Marking strip; plain; 11 mm wide; 50 m reel

 white	2009-110	1
---	----------	---

WMB Inline, plain; 1,500 WMB markers (5 mm)/reel; 5 ... 5.2 mm stretchable

 white	2009-115	1
---	----------	---

WMB marking card; white; 10 strips with 10 markers/card; 5 ... 5.2 mm stretchable

 plain	793-5501	5
---	----------	---

Customizing Modular Female Plugs

WAGO's modular X-COM®S-SYSTEM female plugs can be customized for applications requiring varying numbers of poles (e.g., when designing prototypes).

Modules and Pole Numbers

A customized X-COM®S-SYSTEM female plug consists of:

- One base module with an integrated end plate
- Up to 13 center modules (corresponding to a 15-pole female plug = maximum pole number)
- One end module

Intended Use

According to EN 61984, pluggable connectors without a current interrupting capacity must not be mated or unmated when live or under load.

Mounting

The appropriate mounting tool shall be used in order to guarantee that the individual modules are properly attached to each other without damaging the locking latches.



End module



Center module



Base module

Example: 5-Pole, 1-Conductor Female Plug

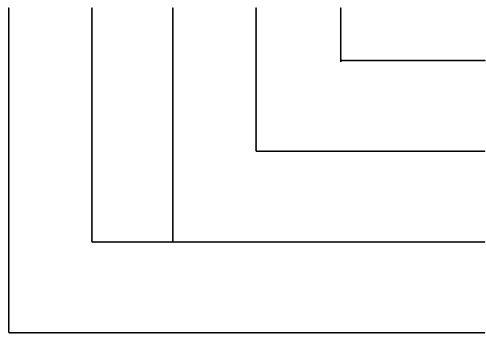

Base module with integrated end plate
2022-167

Center module
2022-174

Center modules
2022-171

End module
2022-181

Pre-Assembled 1-Conductor Female Plug X-COM®S-SYSTEM 2.5 (4) mm²; 2022 Series

Technical Data

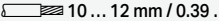
0.25 ... 2.5 (4) mm ² ①	22 ... 12 AWG
690 V / 6 kV / 3 ②	600 V, 20 A ③
I _N 24 A (32 A) ④	600 V, 20 A ⑤
Module width: 5.2 mm / 0.205 inch	
 10 ... 12 mm / 0.39 ... 0.47 inch	

Technical Data

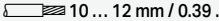
0.25 ... 2.5 (4) mm ² ①	22 ... 12 AWG
690 V / 6 kV / 3 ②	600 V, 20 A ③
I _N 24 A (32 A) ④	600 V, 20 A ⑤
Module width: 5.2 mm / 0.205 inch	
 10 ... 12 mm / 0.39 ... 0.47 inch	

Technical Data

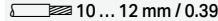
0.25 ... 2.5 (4) mm ² ①	22 ... 12 AWG
690 V / 6 kV / 3 ②	600 V, 20 A ③
I _N 24 A (32 A) ④	600 V, 20 A ⑤
Module width: 5.2 mm / 0.205 inch	
 10 ... 12 mm / 0.39 ... 0.47 inch	

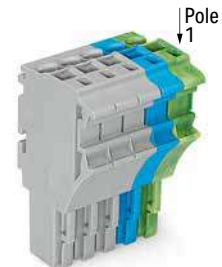
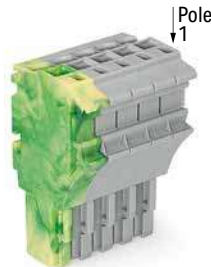
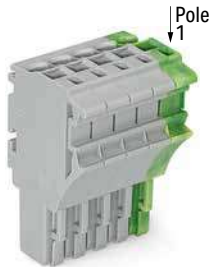

1-conductor female plug; with ground base module (green-yellow); fits into carrier terminal blocks; codable

Pole No.	Item No.	Pack. Unit
3	2022-103/000-036	100
4	2022-104/000-036	100
5	2022-105/000-036	50
6	2022-106/000-036	50
7	2022-107/000-036	50
8	2022-108/000-036	50
9	2022-109/000-036	50
10	2022-110/000-036	25
11	2022-111/000-036	25
12	2022-112/000-036	25
13	2022-113/000-036	25
14	2022-114/000-036	25
15	2022-115/000-036	25

1-conductor female plug; with ground end module (green-yellow); fits into carrier terminal blocks; codable

Pole No.	Item No.	Pack. Unit
3	2022-103/000-037	100
4	2022-104/000-037	100
5	2022-105/000-037	50
6	2022-106/000-037	50
7	2022-107/000-037	50
8	2022-108/000-037	50
9	2022-109/000-037	50
10	2022-110/000-037	25
11	2022-111/000-037	25
12	2022-112/000-037	25
13	2022-113/000-037	25
14	2022-114/000-037	25
15	2022-115/000-037	25

1-conductor female plug; with ground base module (green-yellow); fits into carrier terminal blocks; codable

Pole No.	Item No.	Pack. Unit
3	2022-103/000-038	100
4	2022-104/000-038	100
5	2022-105/000-038	50
6	2022-106/000-038	50
7	2022-107/000-038	50
8	2022-108/000-038	50
9	2022-109/000-038	50
10	2022-110/000-038	25
11	2022-111/000-038	25
12	2022-112/000-038	25
13	2022-113/000-038	25
14	2022-114/000-038	25
15	2022-115/000-038	25

Accessories; for female plugs

Appropriate marking systems: WMB/WMB Inline/Marking strips

Insulation stop; 5 pcs/strip; 0.25 ... 0.5 mm²

	light gray	2002-171	200 (25)
---	------------	----------	----------



Insulation stop; 5 pcs/strip; 0.75 ... 1 mm²

	dark gray	2002-172	200 (25)
---	-----------	----------	----------



Protective warning marker; with black high-voltage symbol; for 5 terminal blocks

	yellow	2002-115	100 (25)
---	--------	----------	----------

Locking lever; 4.8 mm wide

	orange	2022-142	100 (25)
	gray	2022-141	100 (25)

Locking lever; 9.6 mm wide

	orange	2022-152	100 (25)
	gray	2022-151	100 (25)

Carrier with 6 coding pins; for coding female plugs

	orange	2022-100	100 (25)
---	--------	----------	----------

Strain relief plate; gray

	35 mm wide	734-326	100 (25)
	6 mm wide	734-327	100 (25)
	12.5 mm wide	734-328	100 (25)
	25 mm wide	734-329	100 (25)
	55 mm wide	734-430	50 (25)
	75 mm wide	734-431	50 (25)

Marking strip; plain; 11 mm wide; 50 m reel

	white	2009-110	1
---	-------	----------	---

WMB Inline, plain; 1,500 WMB markers (5 mm)/reel; 5 ... 5.2 mm stretchable

	white	2009-115	1
---	-------	----------	---

WMB marking card; white; 10 strips with 10 markers/card; 5 ... 5.2 mm stretchable

	plain	793-5501	5
---	-------	----------	---

Technical Data

0.25 ... 2.5 (4) mm² ① | 22 ... 12 AWG

690 V / 6 kV / 3 ② | 600 V, 20 A ③

I_N 24 A (32 A) ③ | 600 V, 20 A ③

Module width: 5.2 mm / 0.205 inch

10 ... 12 mm / 0.39 ... 0.47 inch

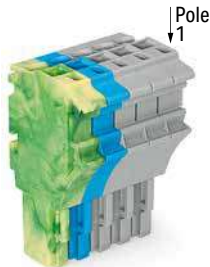

① Conductor range: 0.25 ... 4 mm² "s+f-st";
Push-in termination: 1 ... 4 mm² "s" and 1 ... 2.5 mm² "insulated ferrules, 12 mm"
Depending on the conductor characteristic, a conductor with a smaller cross section can also be inserted via push-in termination.

② 690 V = rated voltage
6 kV = rated impulse voltage
3 = pollution degree
(see Section 15)

③ Current-carrying capacity curves upon request

Note:

According to EN 61984, pluggable connectors without a current interrupting capacity must not be mated or unmated when live or under load.

Approvals and corresponding ratings, visit www.wago.com

1-conductor female plug; with ground end module (green-yellow); fits into carrier terminal blocks; codable

Pole No.	Item No.	Pack. Unit
3	2022-103/000-039	100
4	2022-104/000-039	100
5	2022-105/000-039	50
6	2022-106/000-039	50
7	2022-107/000-039	50
8	2022-108/000-039	50
9	2022-109/000-039	50
10	2022-110/000-039	25
11	2022-111/000-039	25
12	2022-112/000-039	25
13	2022-113/000-039	25
14	2022-114/000-039	25
15	2022-115/000-039	25

1-Conductor Female Plug X-COM®S-SYSTEM; with Lateral Locking Lever and Strain Relief Plate 2.5 (4) mm²; 2022 Series

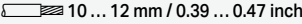
Technical Data	
0.25 ... 2.5 (4) mm ² ①	22 ... 12 AWG
690 V / 6 kV / 3 ②	600 V, 20 A ③
I _N 24 A (32 A) ④	600 V, 20 A ⑤
Module width: 5.2 mm / 0.205 inch	
	

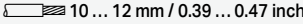
Technical Data	
0.25 ... 2.5 (4) mm ² ①	22 ... 12 AWG
690 V / 6 kV / 3 ②	600 V, 20 A ③
I _N 24 A (32 A) ④	600 V, 20 A ⑤
Module width: 5.2 mm / 0.205 inch	
	

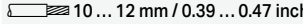
Technical Data	
0.25 ... 2.5 (4) mm ² ①	22 ... 12 AWG
690 V / 6 kV / 3 ②	600 V, 20 A ③
I _N 24 A (32 A) ④	600 V, 20 A ⑤
Module width: 5.2 mm / 0.205 inch	
	



1-conductor female plug; with locking lever; fits into carrier terminal blocks; codable; gray

Pole No.	Item No.	Pack. Unit
○ 1	2022-101/122-000	200
○ 2	2022-102/122-000	100
○ 3	2022-103/123-000	100
○ 4	2022-104/123-000	50
○ 5	2022-105/123-000	50
○ 6	2022-106/123-000	50
○ 7	2022-107/123-000	25
○ 8	2022-108/123-000	25
○ 9	2022-109/123-000	25
○ 10	2022-110/123-000	25
○ 11	2022-111/126-000	25
○ 12	2022-112/126-000	20
○ 13	2022-113/126-000	20
○ 14	2022-114/126-000	10
○ 15	2022-115/127-000	10

1-conductor female plug; with strain relief plate; fits into carrier terminal blocks; codable; gray

Pole No.	Item No.	Pack. Unit
○ 1	2022-101/132-000	200
○ 2	2022-102/132-000	100
○ 3	2022-103/133-000	100
○ 4	2022-104/133-000	50
○ 5	2022-105/134-000	50
○ 6	2022-106/134-000	50
○ 7	2022-107/135-000	25
○ 8	2022-108/135-000	25
○ 9	2022-109/135-000	25
○ 10	2022-110/135-000	25
○ 11	2022-111/136-000	25
○ 12	2022-112/136-000	20
○ 13	2022-113/136-000	20
○ 14	2022-114/136-000	10
○ 15	2022-115/137-000	10

1-conductor female plug; with strain relief plate and locking lever; fits into carrier terminal blocks; codable; gray

Pole No.	Item No.	Pack. Unit
○ 1	2022-101/142-000	200
○ 2	2022-102/142-000	100
○ 3	2022-103/143-000	100
○ 4	2022-104/143-000	50
○ 5	2022-105/144-000	50
○ 6	2022-106/144-000	50
○ 7	2022-107/145-000	25
○ 8	2022-108/145-000	25
○ 9	2022-109/145-000	25
○ 10	2022-110/145-000	25
○ 11	2022-111/146-000	25
○ 12	2022-112/146-000	20
○ 13	2022-113/146-000	20
○ 14	2022-114/146-000	10
○ 15	2022-115/147-000	10

1-conductor female plug; with locking lever; fits into carrier terminal blocks; codable

● 1 blue	2022-101/122-006	200
● 1 green-yellow	2022-101/122-016	200

1-conductor female plug; with strain relief plate; fits into carrier terminal blocks; codable

● 1 blue	2022-101/132-006	200
● 1 green-yellow	2022-101/132-016	200

1-conductor female plug; with strain relief plate and locking lever; fits into carrier terminal blocks; codable

● 1 blue	2022-101/142-006	200
● 1 green-yellow	2022-101/142-016	200

Accessories; for female plugs

Appropriate marking systems: WMB/WMB Inline/Marking strips

Insulation stop; 5 pcs/strip; 0.25 ... 0.5 mm²

	light gray	2002-171	200 (25)
---	------------	----------	----------

Marking strip; plain; 11 mm wide; 50 m reel

	white	2009-110	1
---	-------	----------	---

Insulation stop; 5 pcs/strip; 0.75 ... 1 mm²

	dark gray	2002-172	200 (25)
---	-----------	----------	----------

WMB Inline, plain; 1,500 WMB markers (5 mm)/reel; 5 ... 5.2 mm stretchable

	white	2009-115	1
---	-------	----------	---

Protective warning marker; with black high-voltage symbol; for 5 terminal blocks

	yellow	2002-115	100 (25)
---	--------	----------	----------

WMB marking card; white; 10 strips with 10 markers/card; 5 ... 5.2 mm stretchable

	plain	793-5501	5
---	-------	----------	---

Carrier with 6 coding pins; for coding female plugs

	orange	2022-100	100 (25)
---	--------	----------	----------

1 Conductor range: 0.25 ... 4 mm² "s+f-st";
 Push-in termination: 1 ... 4 mm² "s" and 1 ... 2.5 mm²
 "insulated ferrules, 12 mm"
 Depending on the conductor characteristic, a conductor with a smaller cross section can also be inserted via push-in termination.

2 690 V = rated voltage
 6 kV = rated impulse voltage
 3 = pollution degree
 (see Section 15)

3 Current-carrying capacity curves upon request

Note:
 According to EN 61984, pluggable connectors without a current interrupting capacity must not be mated or unmated when live or under load.

Approvals and corresponding ratings, visit www.wago.com

Strain Relief Plate (SRP), Gray				Locking Lever (LL), Gray				SRP and LL, Gray
Assembled				Assembled				Assembled
SRP				Pole No.	Quantity	1-Way	2-Way	
Item No. Suffix				Item No. Suffix				Item No. Suffix
Item No.	Color	Width						
734-327	gray	6mm	/132-0xx	1 to 2	1	/122-0xx	-	/142-0xx
734-328	gray	12.5mm	/133-0xx	3 to 4	1	-	/123-0xx	/143-0xx
734-329	gray	25mm	/134-0xx	5 to 6	1	-	/123-0xx	/144-0xx
734-326	gray	35mm	/135-0xx	7 to 10	1	-	/123-0xx	/145-0xx
734-430	gray	55mm	/136-0xx	11 to 14	2	-	/126-0xx	/146-0xx
734-431	gray	75mm	/137-0xx	15	2	-	/127-0xx	/147-0xx

For colored female plugs, the item number suffix "xx" must be replaced by the blue "-006" and the green-yellow "-016" color suffix.

Dimensions of locking levers

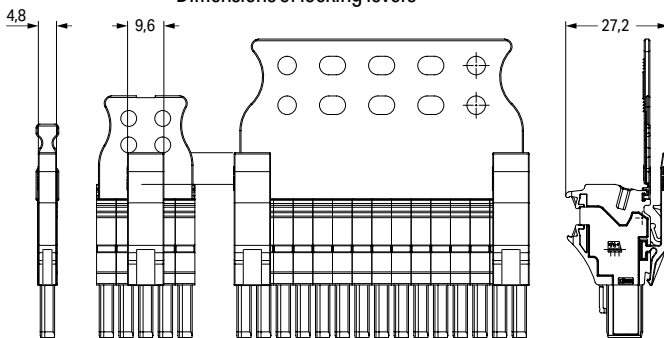

Description	Color	Item No.	Suffix No.
1-conductor female plug	gray	2022-101	none
1- to 15-pole	blue green-yellow	to 2022-115	/000-006 /000-016

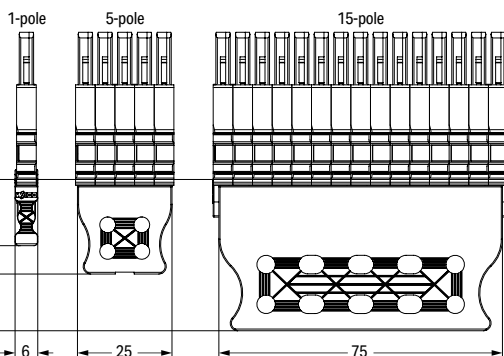
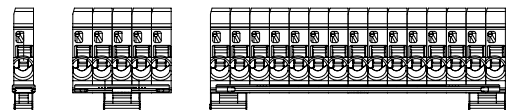

Dimensions of strain relief plates

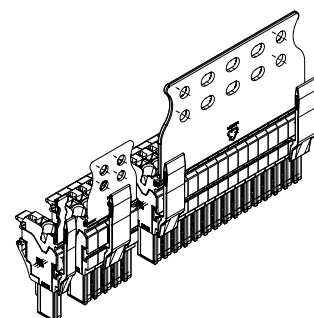

1-Conductor/1-Pin Carrier Terminal Block , 2-Conductor/1-Pin Carrier Terminal Block , 2-Conductor/2-Pin Carrier Terminal Block X-COM®S-SYSTEM; with Push-Button; for Ex ec Applications 2.5 (4) mm²; 2222 Series

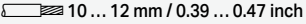
Technical Data	
0.25 ... 2.5 (4) mm ² ①	22 ... 12 AWG
630 V ②	
I _N 20 A	
Terminal block width: 5.2 mm / 0.205 inch	
 10 ... 12 mm / 0.39 ... 0.47 inch	

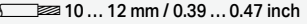
Technical Data	
0.25 ... 2.5 (4) mm ² ①	22 ... 12 AWG
630 V ②	
I _N 20 A	
Terminal block width: 5.2 mm / 0.205 inch	
 10 ... 12 mm / 0.39 ... 0.47 inch	

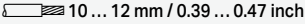
Technical Data	
0.25 ... 2.5 (4) mm ² ①	22 ... 12 AWG
630 V ②	
I _N 20 A	
Terminal block width: 5.2 mm / 0.205 inch	
 10 ... 12 mm / 0.39 ... 0.47 inch	

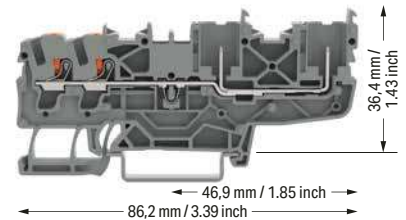
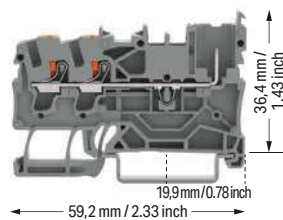
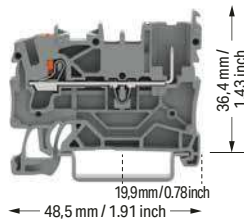

1-conductor/1-pin carrier terminal block; with push-button; suitable for Ex ec applications

Color	Item No.	Pack. Unit
gray ③	2222-1201/999-953	100
blue ③	2222-1204/999-953	100
orange	2222-1202/999-953	100

2-conductor/1-pin carrier terminal block; with push-button; suitable for Ex ec applications

Color	Item No.	Pack. Unit
gray ③	2222-1301/999-953	100
blue ③	2222-1304/999-953	100
orange	2222-1302/999-953	100

2-conductor/2-pin carrier terminal block; with push-button; suitable for Ex ec applications

Color	Item No.	Pack. Unit
gray ③	2222-1401/999-953	50
blue ③	2222-1404/999-953	50
orange	2222-1402/999-953	50

1-conductor/1-pin ground carrier terminal block; suitable for Ex ec applications

Color	Item No.	Pack. Unit
green-yellow ③	2222-1207/999-953	100



2-conductor/1-pin ground carrier terminal block; suitable for Ex ec applications

Color	Item No.	Pack. Unit
green-yellow ③	2222-1307/999-953	100

2-conductor/2-pin ground carrier terminal block; suitable for Ex ec applications

Color	Item No.	Pack. Unit
green-yellow ③	2222-1407/999-953	50

Accessories; item-specific

End and intermediate plate; 1 mm thick			
	orange	2022-1292	100 (25)
	gray	2022-1291	100 (25)

Accessories; item-specific

End and intermediate plate; 1 mm thick			
	orange	2022-1392	100 (25)
	gray	2022-1391	100 (25)

Accessories; item-specific

End and intermediate plate; 1 mm thick			
	orange	2022-1492	100 (25)
	gray	2022-1491	100 (25)

Accessories; 2222 Series

Appropriate marking systems: WMB/WMB Inline/marketing strips

Insulation stop; 5 pcs/strip; 0.25 ... 0.5 mm²

	light gray	2002-171	200 (25)
---	------------	----------	----------

Insulation stop; 5 pcs/strip; 0.75 ... 1 mm²

	dark gray	2002-172	200 (25)
---	-----------	----------	----------

Push-in type jumper bar; insulated; I_N 25 A; light gray

	2-way	2002-402	25
	3-way	2002-403	25
	4-way	2002-404	25
	5-way	2002-405	25
	6-way	2002-406	25
	7-way	2002-407	25
	8-way	2002-408	25
	9-way	2002-409	25
	10-way	2002-410	25

Push-in type jumper bar; insulated; I_N 25 A; light gray

	1 to 3	2002-433	25
	1 to 4	2002-434	25
	1 to 5	2002-435	25
	1 to 6	2002-436	25
	1 to 7	2002-437	25
	1 to 8	2002-438	25
	1 to 9	2002-439	25
	1 to 10	2002-440	25

Staggered jumper; insulated; I_N 25 A; light gray

	2-way	2002-472	25
	3-way	2002-473	25
	4-way	2002-474	25
	5-way	2002-475	25
	6-way	2002-476	25
	7-way	2002-477	25
	8-way	2002-478	25
	9-way	2002-479	25
	10-way	2002-480	25
	11-way	2002-481	25
	12-way	2002-482	25

Continuous jumper; insulated; I_N 25 A; light gray

	2-way	2002-400	25
---	-------	----------	----

Continuous jumper; insulated; I_N 25 A; light gray

	1 to 3	2002-423	25
	1 to 4	2002-424	25

Continuous jumper; insulated; I_N 25 A; light gray

	3-way	2002-413	25
	5-way	2002-415	25

Push-in type wire jumper; insulated; 1.5 mm² conductor cross-section; I_N 18 A

	L = 60 mm	2009-412	100 (10)
	L = 110 mm	2009-414	100 (10)
	L = 250 mm	2009-416	100 (10)

Carrier with 6 coding pins; for coding female plugs

	orange	2022-100	100 (25)
---	--------	----------	----------

Test pin; 1 mm Ø

		859-500	1
---	--	---------	---

1-conductor female plug; with shorter locking lever; suitable for Ex ec applications; fits into carrier terminal blocks; codable

	gray	2022-103/999-953	100
---	------	------------------	-----

Marking strip; plain; 11 mm wide; 50 m reel

	white	2009-110	1
---	-------	----------	---

WMB Inline; plain; 1,500 WMB markers (5 mm)/reel; stretchable 5 ... 5.2 mm

	white	2009-115	1
---	-------	----------	---

WMB marker card; white; 10 strips with 10 markers/card; stretchable 5 ... 5.2 mm

	plain	793-5501	5
---	-------	----------	---

❶ Conductor range: 0.25 ... 4 mm² "s+f-st"
 Push-in termination: 1 ... 4 mm² "s" and 1 ... 2.5 mm²
 "insulated ferrules, 12 mm"
 Depending on the conductor characteristic, a conductor with a smaller cross-section can also be inserted via push-in termination.

❷ 630 V = rated voltage for use in Zone 2 hazardous areas, "ec" type of protection (see Section 15)

Note:

When used as intended, female plugs must not be connected/disconnected when live or under load.

Please observe the application notes:
 Jumpers, from page 182
 Marking, from page 684

Approvals and corresponding ratings, visit www.wago.com

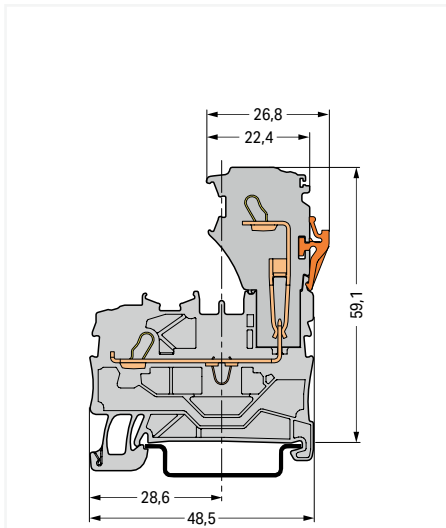

Carrier terminal block

630 V = rated voltage for use in Zone 2 hazardous areas, "ec" type of protection

Ex marking:

"Ex" sign and extended item number ".../999-953" are printed on the side of both carrier terminal blocks and female plugs with Ex approval.

Shorter locking lever (factory-mounted) makes accidental disconnection more difficult.

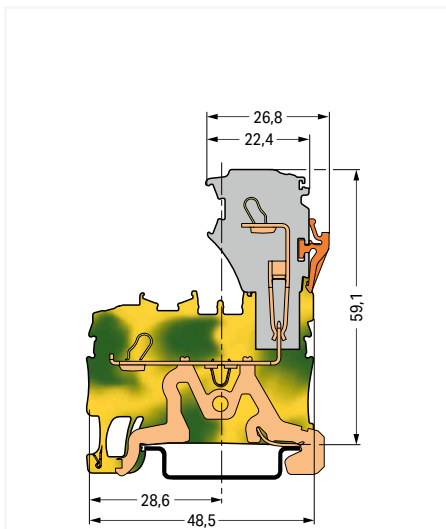

Ground carrier terminal block

1-Conductor/1-Pin Carrier Terminal Block, 2-Conductor/1-Pin Carrier Terminal Block, 2-Conductor/2-Pin Carrier Terminal Block X-COM®S-SYSTEM; for Ex ec Applications 2.5 (4) mm²; 2022 Series

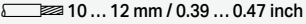
Technical Data	
0.25 ... 2.5 (4) mm ² ①	22 ... 12 AWG
630 V ②	600 V, 20 A ③
I _N 20 A	600 V, 20 A ④
Terminal block width: 5.2 mm / 0.205 inch	
 10 ... 12 mm / 0.39 ... 0.47 inch	

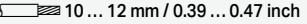
Technical Data	
0.25 ... 2.5 (4) mm ² ①	22 ... 12 AWG
630 V ②	600 V, 20 A ③
I _N 20 A	600 V, 20 A ④
Terminal block width: 5.2 mm / 0.205 inch	
 10 ... 12 mm / 0.39 ... 0.47 inch	

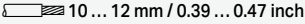
Technical Data	
0.25 ... 2.5 (4) mm ² ①	22 ... 12 AWG
630 V ②	600 V, 20 A ③
I _N 20 A	600 V, 20 A ④
Terminal block width: 5.2 mm / 0.205 inch	
 10 ... 12 mm / 0.39 ... 0.47 inch	

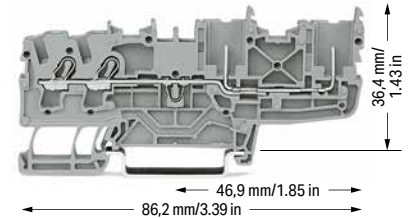
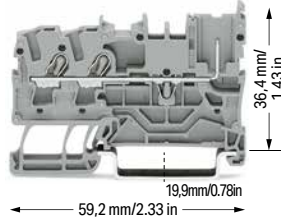
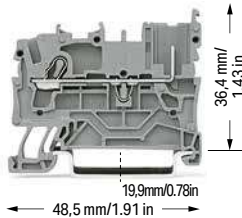

1-conductor/1-pin carrier terminal block; suitable for Ex ec applications		
Color	Item No.	Pack. Unit
gray ⑤	2022-1201/999-953	100
blue ⑤	2022-1204/999-953	100



2-conductor/1-pin carrier terminal block; suitable for Ex ec applications		
Color	Item No.	Pack. Unit
gray ⑤	2022-1301/999-953	100
blue ⑤	2022-1304/999-953	100



2-conductor/2-pin carrier terminal block; suitable for Ex ec applications		
Color	Item No.	Pack. Unit
gray ⑤	2022-1401/999-953	50
blue ⑤	2022-1404/999-953	50



1-conductor/1-pin ground carrier terminal block; suitable for Ex ec applications		
Color	Item No.	Pack. Unit
green-yellow ⑤	2022-1207/999-953	100

2-conductor/1-pin ground carrier terminal block; suitable for Ex ec applications		
Color	Item No.	Pack. Unit
green-yellow ⑤	2022-1307/999-953	100

2-conductor/2-pin ground carrier terminal block; suitable for Ex ec applications		
Color	Item No.	Pack. Unit
green-yellow ⑤	2022-1407/999-953	50

Accessories; item-specific			
End and intermediate plate; 1 mm thick			
	orange	2022-1292	100 (25)
	gray	2022-1291	100 (25)

Accessories; item-specific			
End and intermediate plate; 1 mm thick			
	orange	2022-1392	100 (25)
	gray	2022-1391	100 (25)

Accessories; item-specific			
End and intermediate plate; 1 mm thick			
	orange	2022-1492	100 (25)
	gray	2022-1491	100 (25)

Accessories; 2022 Series

Appropriate marking systems: WMB/WMB Inline/Marking strips

Insulation stop; 5 pcs/strip; 0.25 ... 0.5 mm ²			
	light gray	2002-171	200 (25)

Insulation stop; 5 pcs/strip; 0.75 ... 1 mm ²			
	dark gray	2002-172	200 (25)

Protective warning marker; with black high-voltage symbol; for 5 terminal blocks			
	yellow	2002-115	100 (25)

Push-in type jumper bar; insulated; I _N 25 A; light gray			
	2-way	2002-402	25
	3-way	2002-403	25
	4-way	2002-404	25
	5-way	2002-405	25
	6-way	2002-406	25
	7-way	2002-407	25
	8-way	2002-408	25
	9-way	2002-409	25
	10-way	2002-410	25

Push-in type jumper bar; insulated; I _N 25 A; light gray			
	1 to 3	2002-433	25
	1 to 4	2002-434	25
	1 to 5	2002-435	25
	1 to 6	2002-436	25
	1 to 7	2002-437	25
	1 to 8	2002-438	25
	1 to 9	2002-439	25
	1 to 10	2002-440	25

Staggered jumper; insulated; I _N 25 A; light gray			
	2-way	2002-472	25
	3-way	2002-473	25
	4-way	2002-474	25
	5-way	2002-475	25
	6-way	2002-476	25
	7-way	2002-477	25
	8-way	2002-478	25
	9-way	2002-479	25
	10-way	2002-480	25
	11-way	2002-481	25
	12-way	2002-482	25

Push-in type wire jumper; insulated; 1.5 mm ² conductor cross-section; I _N 18 A			
	L = 60 mm	2009-412	100 (10)
	L = 110 mm	2009-414	100 (10)
	L = 250 mm	2009-416	100 (10)

Carrier with 6 coding pins; for coding female plugs			
	orange	2002-100	100 (25)

Test pin; 1 mm Ø			
		859-500	1

1-conductor female plug; with shorter locking lever; suitable for Ex ec applications; fits into carrier terminal blocks; codable			
	gray	2022-103/999-953	100

Marking strip; plain; 11 mm wide; 50 m reel			
	white	2009-110	1

WMB Inline, plain; 1,500 WMB markers (5 mm)/reel; 5 ... 5.2 mm stretchable			
	white	2009-115	1

WMB marking card; white; 10 strips with 10 markers/card; 5 ... 5.2 mm stretchable			
	plain	793-5501	5

1 Conductor range: 0.25 ... 4 mm² "s+f-st";
 Push-in termination: 1 ... 4 mm² "s" and 1 ... 2.5 mm²
 "insulated ferrules, 12 mm"
 Depending on the conductor characteristic, a conductor
 with a smaller cross section can also be inserted
 via push-in termination.

2 630 V = rated voltage for use in Zone 2 hazardous
 areas, "nA" type of protection
 (see Section 15)

Note:

When used as intended, female plugs must not be
 connected/disconnected when live or under load.

Please observe the application notes:
 Jumpers, from page 182
 Marking, from page 684

Approvals and corresponding ratings,
 visit www.wago.com



630 V = rated voltage for use in Zone 2 hazardous areas,
 "nA" type of protection

Ex marking:

"Ex" sign and extended item number ".../999-953" are
 printed on the side of both carrier terminal blocks and
 female plugs with Ex approval.
 Shorter locking lever (factory-mounted) makes accidental
 disconnection more difficult.

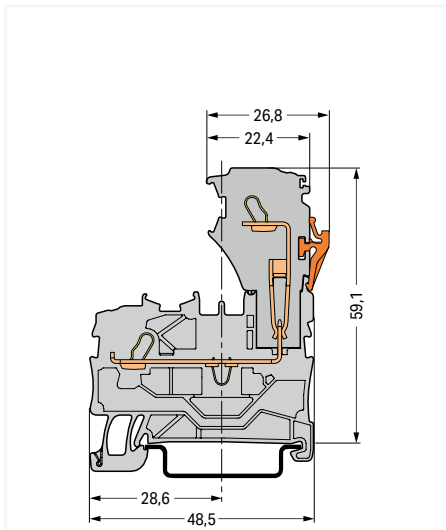

Carrier terminal block

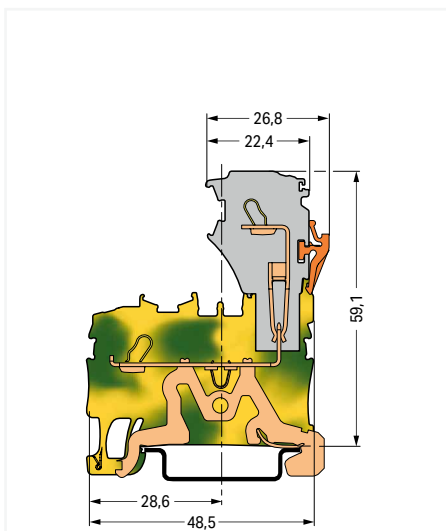

Ground carrier terminal block

2-Pin Carrier Terminal Block and 4-Pin Carrier Terminal Block X-COM®S-SYSTEM; for Ex ec Applications 2022 Series

Technical Data	
630 V 1	600 V, 20 A 1A
I _N 20 A 2	600 V, 20 A 2E
Terminal block width: 5.2 mm / 0.205 inch	

Technical Data	
630 V 1	600 V, 20 A 1A
I _N 20 A 2	600 V, 20 A 2E
Terminal block width: 5.2 mm / 0.205 inch	

1 630 V = rated voltage for use in Zone 2 hazardous areas, "nA" type of protection (see Section 15)

Note:

When used as intended, female plugs must not be connected/disconnected when live or under load.

Please observe the application notes:
Jumpers, from page 182
Marking, from page 684

Approvals and corresponding ratings, visit www.wago.com

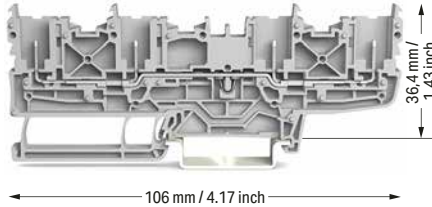
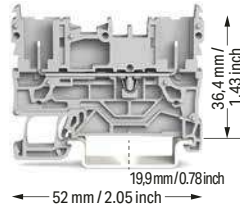

2-pin carrier terminal block; for Ex ec applications		
Color	Item No.	Pack. Unit
gray 3	2022-1601/999-953	50
blue 4	2022-1604/999-953	50

4-pin carrier terminal block; for Ex ec applications		
Color	Item No.	Pack. Unit
gray 3	2022-1801/999-953	50
blue 4	2022-1804/999-953	50

2-pin ground carrier terminal block; for Ex ec applications		
Color	Item No.	Pack. Unit
green-yellow 5	2022-1607/999-953	50

4-pin ground carrier terminal block; for Ex ec applications		
Color	Item No.	Pack. Unit
green-yellow 5	2022-1807/999-953	50

Accessories; item-specific			
End plate; 1 mm thick			
	orange	2022-1692	100 (25)
	gray	2022-1691	100 (25)

Accessories; item-specific			
End plate; 1 mm thick			
	orange	2022-1892	100 (25)
	gray	2022-1891	100 (25)

Accessories; 2022 Series

Appropriate marking systems:
WMB/WMB Inline/Marking strips

Marking strip; plain; 11 mm wide; 50 m reel			
	white	2009-110	1

WMB Inline, plain; 1,500 WMB markers (5 mm)/reel; 5 ... 5.2 mm stretchable

	white	2009-115	1
--	-------	----------	---

WMB marking card; white; 10 strips with 10 markers/card; 5 ... 5.2 mm stretchable

	plain	793-5501	5
--	-------	----------	---

Accessories; 2022 Series Appropriate marking systems: WMB/WMB Inline/Marking strips

Push-in type jumper bar; insulated; I _N 25 A; light gray			
	2-way	2002-402	25
	3-way	2002-403	25
	4-way	2002-404	25
	5-way	2002-405	25
	6-way	2002-406	25
	7-way	2002-407	25
	8-way	2002-408	25
	9-way	2002-409	25
	10-way	2002-410	25

Staggered jumper; insulated; I _N 25 A; light gray			
	2-way	2002-472	25
	3-way	2002-473	25
	4-way	2002-474	25
	5-way	2002-475	25
	6-way	2002-476	25
	7-way	2002-477	25
	8-way	2002-478	25
	9-way	2002-479	25
	10-way	2002-480	25
	11-way	2002-481	25
	12-way	2002-482	25

Push-in type jumper bar; insulated; I _N 25 A; light gray			
	1 to 3	2002-433	25
	1 to 4	2002-434	25
	1 to 5	2002-435	25
	1 to 6	2002-436	25
	1 to 7	2002-437	25
	1 to 8	2002-438	25
	1 to 9	2002-439	25
	1 to 10	2002-440	25

Continuous jumper; insulated; I _N 25 A; light gray			
	1 to 3	2002-423	25
	1 to 4	2002-424	25

Delta jumper; insulated; I _N = I _N terminal block; light gray			
	1-2-3-4-5-6	2002-406/020-000	25

Continuous jumper; insulated; I _N 25 A; light gray			
	3-way	2002-413	25
	5-way	2002-415	25

Star point jumper; insulated; I _N = I _N terminal block; light gray			
	1-3-5	2002-405/011-000	25

Push-in type wire jumper; insulated; 1.5 mm ² conductor cross-section; I _N 18 A			
	L = 60 mm	2009-412	100 (10)
	L = 110 mm	2009-414	100 (10)
	L = 250 mm	2009-416	100 (10)

Continuous jumper; insulated; I _N 25 A; light gray			
	2-way	2002-400	25

Carrier with 6 coding pins; for coding female plugs			
	orange	2022-100	100 (25)

1-conductor female plug			
	gray	2022-101	200

1-Conductor/1-Pin Double-Deck Carrier Terminal Block X-COM®S-SYSTEM; for Ex ec Applications

2.5 (4) mm²; 2022 Series

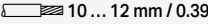
Technical Data	
0.25 ... 2.5 (4) mm ² ①	22 ... 12 AWG
630 V ②	600 V; 20 A ③
I _N 20 A	600 V; 20 A ④
Terminal block width: 5.2 mm / 0.205 inch	
 10 ... 12 mm / 0.39 ... 0.47 inch	

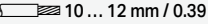
Technical Data	
0.25 ... 2.5 (4) mm ² ①	22 ... 12 AWG
630 V ②	600 V; 20 A ③
I _N 20 A	600 V; 20 A ④
Terminal block width: 5.2 mm / 0.205 inch	
 10 ... 12 mm / 0.39 ... 0.47 inch	

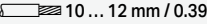
Technical Data	
0.25 ... 2.5 (4) mm ² ①	22 ... 12 AWG
630 V ②	600 V; 20 A ③
I _N 20 A	600 V; 20 A ④
Terminal block width: 5.2 mm / 0.205 inch	
 10 ... 12 mm / 0.39 ... 0.47 inch	

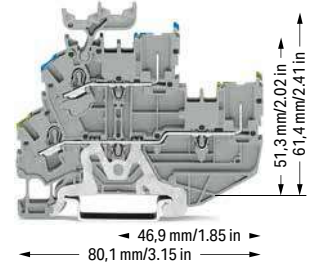
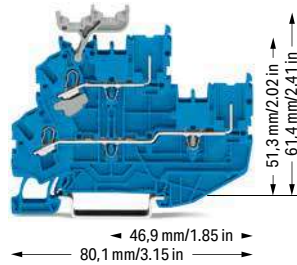
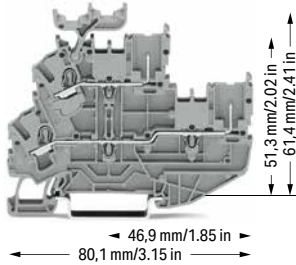

1-conductor/1-pin double-deck carrier terminal block; through/through terminal block; with marker carrier; suitable for Ex ec applications; gray

	Item No.	Pack. Unit
○ L/L ⑤	2022-2231/999-953	50
○ N/L ⑤	2022-2232/999-953	50
○ L/N ⑤	2022-2233/999-953	50

1-conductor/1-pin double-deck carrier terminal block; through/through terminal block; with marker carrier; suitable for Ex ec applications; blue

	Item No.	Pack. Unit
● N/N ⑤	2022-2234/999-953	50

1-conductor/1-pin double-deck carrier terminal block; ground conductor/through terminal block; with marker carrier; for Ex ec applications; gray

	Item No.	Pack. Unit
○ PE/N ⑤	2022-2247/999-953	50
○ PE/L ⑤	2022-2257/999-953	50

1-conductor/1-pin double-deck carrier terminal block; through/through terminal block; without marker carrier; for Ex ec applications; gray

○ L/L ⑤	2022-2201/999-953	50
○ N/L ⑤	2022-2202/999-953	50
○ L/N ⑤	2022-2203/999-953	50

1-conductor/1-pin double-deck carrier terminal block; through/through terminal block; without marker carrier; for Ex ec applications; blue

● N/N ⑤	2022-2204/999-953	50
---------	-------------------	----

1-conductor/1-pin double-deck carrier terminal block; ground conductor/through terminal block; without marker carrier; for Ex ec applications; gray

○ PE/N ⑤	2022-2217/999-953	50
○ PE/L ⑤	2022-2227/999-953	50

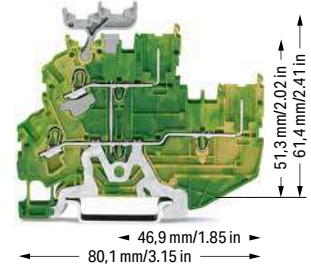
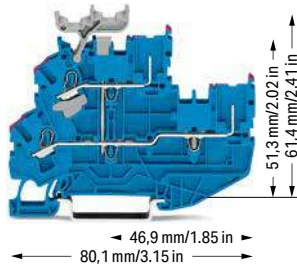
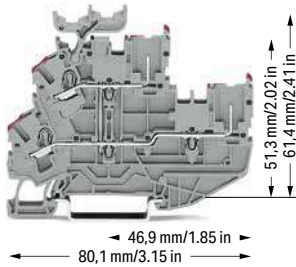

2-conductor/2-pin double-deck carrier terminal block; 2-conductor/2-pin through terminal block; with marker carrier, internally commoned; violet conductor entry; for Ex ec applications; gray

	Item No.	Pack. Unit
○ L ⑤	2022-2238/999-953	50

2-conductor/2-pin double-deck carrier terminal block; 2-conductor/2-pin through terminal block; with marker carrier, internally commoned; violet conductor entry; for Ex ec applications; blue

	Item No.	Pack. Unit
● N ⑤	2022-2239/999-953	50

2-conductor/2-pin double-deck carrier block; 2-conductor/2-pin ground conductor block; with marker carrier; internally commoned; for Ex ec applications; green-yellow

	Item No.	Pack. Unit
● PE ⑤	2022-2237/999-953	50

2-conductor/2-pin double-deck carrier terminal block; 2-conductor/2-pin through terminal block; without marker carrier, internally commoned; violet conductor entry; for Ex ec applications; gray

○ L ⑤	2022-2208/999-953	50
-------	-------------------	----

2-conductor/2-pin double-deck carrier terminal block; 2-conductor/2-pin through terminal block; without marker carrier, internally commoned; violet conductor entry; for Ex ec applications; blue

● N ⑤	2022-2209/999-953	50
-------	-------------------	----

2-conductor/2-pin double-deck carrier block; 2-conductor/2-pin ground conductor block; without marker carrier; internally commoned; for Ex ec applications; green-yellow

● PE ⑤	2022-2207/999-953	50
--------	-------------------	----

1 Conductor range: 0.25 ... 4 mm² "s+f-st";
Push-in termination: 1 ... 4 mm² "s" and 1 ... 2.5 mm² "insulated ferrules, 12 mm"
Depending on the conductor characteristic, a conductor with a smaller cross section can also be inserted via push-in termination.

2 630 V = rated voltage for use in Zone 2 hazardous areas, "nA" type of protection (see Section 15) with double-deck vertical jumper,

Note:
When used as intended, female plugs must not be connected/disconnected when live or under load.

Please observe the application notes:
Jumpers, from page 182
Marking, from page 684

Approvals and corresponding ratings, visit www.wago.com

Accessories; 2022 Series
Appropriate marking systems:
WMB/WMB Inline/Marking strips

End and intermediate plate; 1 mm thick

	orange	2022-2292	100 (25)
	gray	2022-2291	100 (25)

Insulation stop; 5 pcs/strip; 0.25 ... 0.5 mm²

	light gray	2002-171	200 (25)
--	------------	----------	----------

Insulation stop; 5 pcs/strip; 0.75 ... 1 mm²

	dark gray	2002-172	200 (25)
---	-----------	----------	----------

Protective warning marker; with black high-voltage symbol; for 5 terminal blocks

	yellow	2002-115	100 (25)
---	--------	----------	----------

Push-in type jumper bar; insulated; I_N 25 A; light gray

	2-way	2002-402	25
	3-way	2002-403	25
	4-way	2002-404	25
	5-way	2002-405	25
	6-way	2002-406	25
	7-way	2002-407	25
	8-way	2002-408	25
	9-way	2002-409	25
	10-way	2002-410	25

Push-in type jumper bar; insulated; I_N 25 A; light gray

	1 to 3	2002-433	25
	1 to 4	2002-434	25
	1 to 5	2002-435	25
	1 to 6	2002-436	25
	1 to 7	2002-437	25
	1 to 8	2002-438	25
	1 to 9	2002-439	25
	1 to 10	2002-440	25

Continuous jumper; insulated; I_N 25 A, light gray

	2-way	2002-400	25
---	-------	----------	----

Continuous jumper; insulated; I_N 25 A; light gray

	1 to 3	2002-423	25
	1 to 4	2002-424	25

Continuous jumper; insulated; I_N 25 A, light gray

	3-way	2002-413	25
	5-way	2002-415	25

Accessories; 2022 Series
Appropriate marking systems:
WMB/WMB Inline/Marking strips

Double-deck vertical jumper; insulated; I_N 24 A

	light gray	2002-492	100 (25)
	orange	2002-492/000-012	100 (25)

Carrier with 6 coding pins; for coding female plugs

	orange	2022-100	100 (25)
---	--------	----------	----------

Test pin; 1 mm Ø

		859-500	1
---	--	---------	---

Test plug adapter; for 4 mm Ø test plug

	gray	2009-174	100 (25)
---	------	----------	----------

Testing tap; for max. 2.5 mm²

	gray	2009-182	100 (25)
---	------	----------	----------

1-conductor female plug; with shorter locking lever; suitable for Ex ec applications; fits into carrier terminal blocks; codable

	gray	2022-103/999-953	100
--	------	------------------	-----

Marking strip; plain; 11 mm wide; 50 m reel

	white	2009-110	1
---	-------	----------	---

WMB Inline, plain; 1,500 WMB markers (5 mm)/reel; 5 ... 5.2 mm stretchable

	white	2009-115	1
---	-------	----------	---

WMB marking card; white; 10 strips with 10 markers/card; 5 ... 5.2 mm stretchable

	plain	793-5501	5
---	-------	----------	---

Double-deck marker carrier; pivoting

	gray	2002-121	50 (25)
---	------	----------	---------

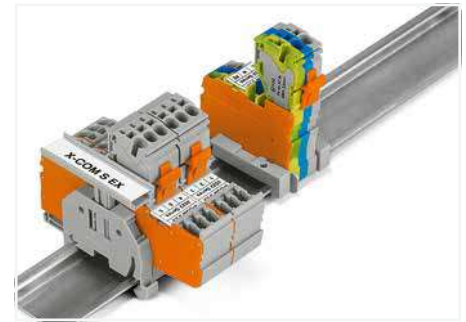

Group marking with height-adjustable group marker carrier (2009-163)

1-Conductor Female Plug X-COM®S-SYSTEM; for Ex ec Applications 2.5 (4) mm²; 2022 Series

Technical Data

0.25 ... 2.5 (4) mm² ① | 22 ... 12 AWG

630 V ② | 600 V, 20 A ③

I_N 20 A | 600 V, 20 A ④

Module width: 5.2 mm / 0.205 inch

10 ... 12 mm / 0.39 ... 0.47 inch



Dimensions (in mm):

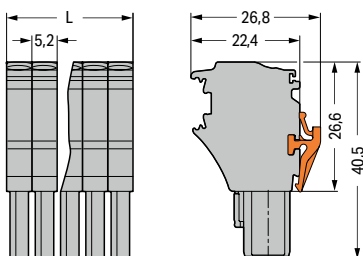

L = pole no. x module width

1-conductor female plug; with shorter locking lever; suitable for Ex ec applications; fits into carrier terminal blocks; codable; gray

According to EN 61984, pluggable connectors without a current interrupting capacity must not be mated or unmated when live or under load.

Pole No.	Item No.	Pack. Unit
2	2022-102/999-953	200
3	2022-103/999-953	100
4	2022-104/999-953	100
5	2022-105/999-953	50
6	2022-106/999-953	50
7	2022-107/999-953	50
8	2022-108/999-953	50

Accessories; for female plugs

Appropriate marking systems:
WMB/WMB Inline/Marking strips

Insulation stop; 5 pcs/strip; 0.25 ... 0.5 mm²

light gray | 2002-171 | 200 (25)



Insulation stop; 5 pcs/strip; 0.75 ... 1 mm²

dark gray | 2002-172 | 200 (25)



Protective warning marker; with black high-voltage symbol; for 5 terminal blocks

yellow | 2002-115 | 100 (25)



Carrier with 6 coding pins; for coding female plugs

orange | 2022-100 | 100 (25)



① Conductor range: 0.25 ... 4 mm² "s+f-st";
Push-in termination: 1 ... 4 mm² "s" and 1 ... 2.5 mm² "insulated ferrules, 12 mm"
Depending on the conductor characteristic, a conductor with a smaller cross section can also be inserted via push-in termination.

② 630 V = rated voltage for use in Zone 2 hazardous areas, "nA" type of protection (see Section 15)

Approvals and corresponding ratings, visit www.wago.com

Accessories; for female plugs

Appropriate marking systems:
WMB/WMB Inline/Marking strips

Strain relief plate; gray

35 mm wide | 734-326 | 100 (25)

6 mm wide | 734-327 | 100 (25)

12.5 mm wide | 734-328 | 100 (25)

25 mm wide | 734-329 | 100 (25)

55 mm wide | 734-430 | 50 (25)

75 mm wide | 734-431 | 50 (25)

Marking strip; plain; 11 mm wide; 50 m reel

white | 2009-110 | 1

WMB Inline, plain; 1,500 WMB markers (5 mm)/reel; 5 ... 5.2 mm stretchable

white | 2009-115 | 1

WMB marking card; white; 10 strips with 10 markers/card; 5 ... 5.2 mm stretchable

plain | 793-5501 | 5



Each female plug is supplied with a locking lever.



Coding a female plug: remove coding finger using a suitable tool.

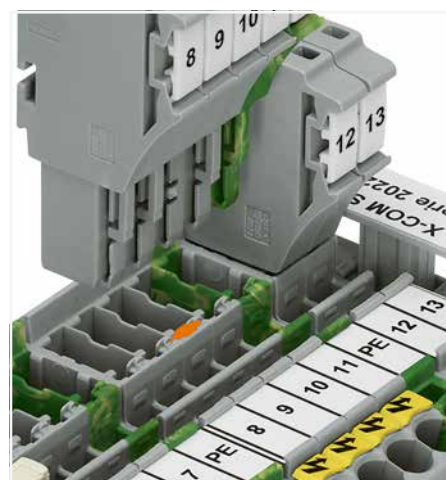

Insert a coding pin (2022-100) into the corresponding location of the carrier terminal block.

Pre-Assembled 1-Conductor Female Plug X-COM®S-SYSTEM; for Ex ec Applications 2.5 (4) mm²; 2022 Series

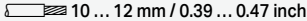
Technical Data	
0.25 ... 2.5 (4) mm ² ①	22 ... 12 AWG
630 V ②	600 V, 20 A I_N
I_N 20 A	600 V, 20 A I_N
Module width: 5.2 mm / 0.205 inch	
 10 ... 12 mm / 0.39 ... 0.47 inch	

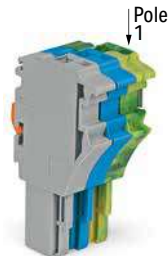

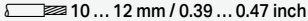
Technical Data	
0.25 ... 2.5 (4) mm ² ①	22 ... 12 AWG
630 V ②	600 V, 20 A I_N
I_N 20 A	600 V, 20 A I_N
Module width: 5.2 mm / 0.205 inch	
 10 ... 12 mm / 0.39 ... 0.47 inch	



1-conductor female plug; with shorter locking lever; with ground base module (green-yellow); fits into carrier terminal blocks; codable

Pole No.	Item No.	Pack. Unit
3 \oplus	2022-103/000-038/999-953	100
4 \oplus	2022-104/000-038/999-953	100
5 \oplus	2022-105/000-038/999-953	50
6 \oplus	2022-106/000-038/999-953	50

1-conductor female plug; with shorter locking lever; with ground end module (green-yellow); fits into carrier terminal blocks; codable

Pole No.	Item No.	Pack. Unit
3 \oplus	2022-103/000-039/999-953	100
4 \oplus	2022-104/000-039/999-953	100
5 \oplus	2022-105/000-039/999-953	50
6 \oplus	2022-106/000-039/999-953	50

Accessories; for female plugs

Appropriate marking systems: WMB/WMB Inline/Marking strips

Insulation stop; 5 pcs/strip; 0.25 ... 0.5 mm²

	light gray	2002-171	200 (25)
---	------------	----------	----------

Insulation stop; 5 pcs/strip; 0.75 ... 1 mm²

	dark gray	2002-172	200 (25)
---	-----------	----------	----------

Protective warning marker; with black high-voltage symbol; for 5 terminal blocks

	yellow	2002-115	100 (25)
---	--------	----------	----------

Carrier with 6 coding pins; for coding female plugs

	orange	2022-100	100 (25)
---	--------	----------	----------

Strain relief plate; gray

	35 mm wide	734-326	100 (25)
	6 mm wide	734-327	100 (25)
	12.5 mm wide	734-328	100 (25)
	25 mm wide	734-329	100 (25)
	55 mm wide	734-430	50 (25)
	75 mm wide	734-431	50 (25)

Marking strip; plain; 11 mm wide; 50 m reel

	white	2009-110	1
---	-------	----------	---

WMB Inline, plain; 1,500 WMB markers (5 mm)/reel; 5 ... 5.2 mm stretchable

	white	2009-115	1
---	-------	----------	---

WMB marking card; white; 10 strips with 10 markers/card; 5 ... 5.2 mm stretchable

	plain	793-5501	5
---	-------	----------	---

① Conductor range: 0.25 ... 4 mm² "s+f-st"; Push-in termination: 1 ... 4 mm² "s" and 1 ... 2.5 mm² "insulated ferrules, 12 mm"
Depending on the conductor characteristic, a conductor with a smaller cross section can also be inserted via push-in termination.

② 630 V = rated voltage for use in Zone 2 hazardous areas, "nA" type of protection (see Section 15)

Note:

According to EN 61984, pluggable connectors without a current interrupting capacity must not be mated or unmated when live or under load.

Approvals and corresponding ratings, visit www.wago.com

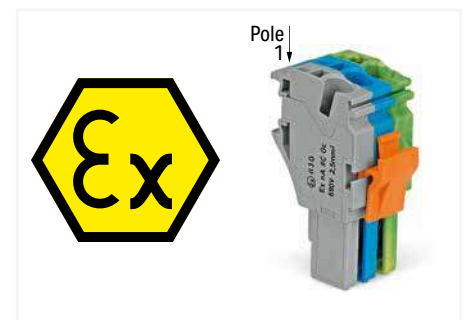





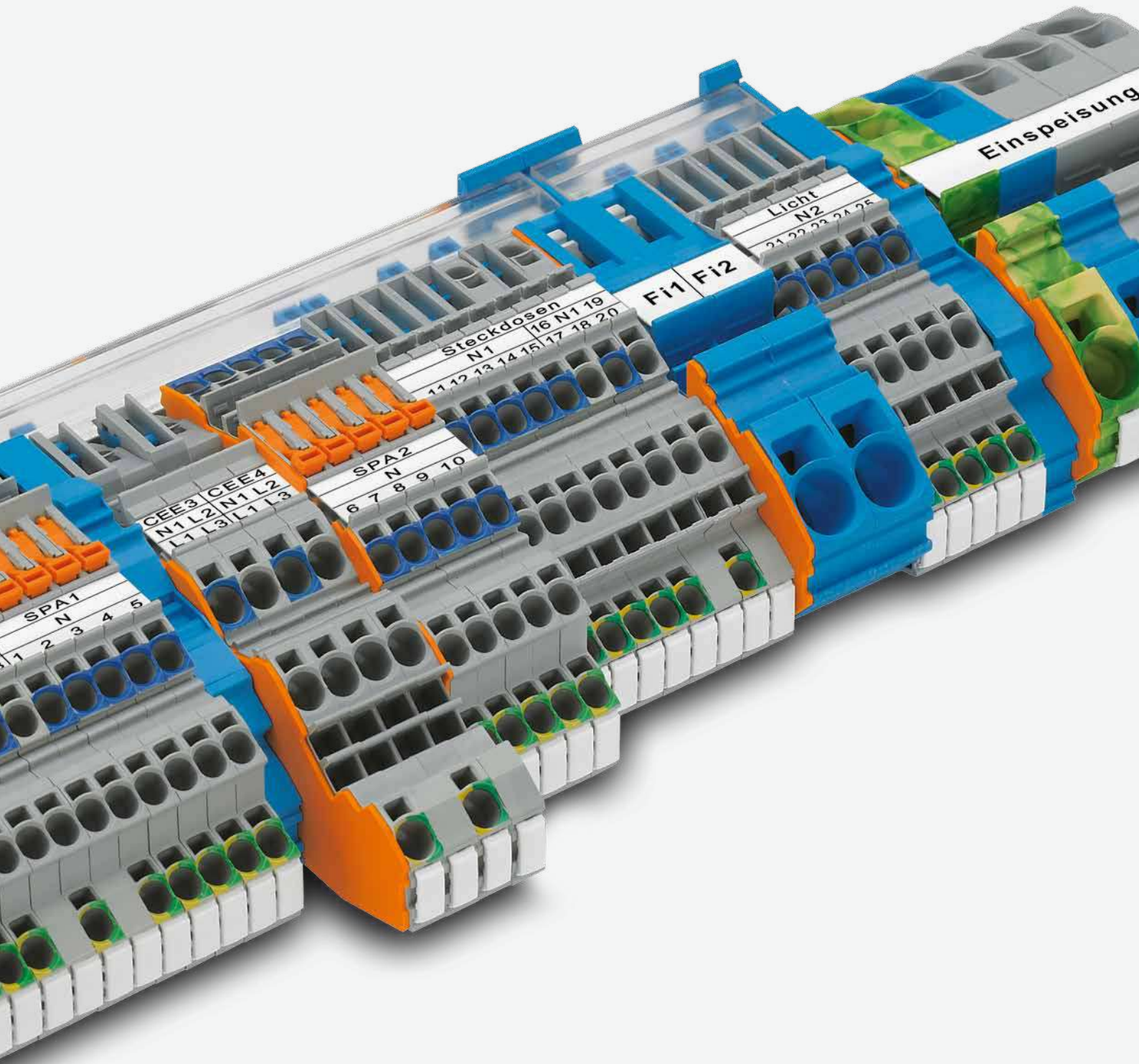



Ex marking:

"Ex" sign and extended item number ".../999-953" are printed on the side of both carrier terminal blocks and female plugs with Ex approval. Shorter locking lever (factory-mounted) makes accidental disconnection more difficult.



WAGO Installation Rail-Mount Terminal Blocks TOPJOB® S

WAGO Installation Rail-Mount Terminal Blocks TOPJOB® S

			Page
	Multilevel Installation Terminal Blocks; with Operating Slot and Push-Button; with N-Disconnect Slide Link	2203 Series	240
	0.25 ... 2.5 (4) mm ² (22 ... 12 AWG)	2203 Series	248
	Multilevel Installation Terminal Blocks; with Operating Slot and Push-Button; with Internal N-Disconnect	2003 Series	256
	0.25 ... 2.5 (4) mm ² (22 ... 12 AWG)		
	Multilevel Installation Terminal Blocks; with Internal N-Disconnection	2203 Series	242
	0.25 ... 2.5 (4) mm ² (22 ... 12 AWG)	2203 Series	250
	Multilevel Installation Terminal Blocks; with Internal N-Disconnection	2003 Series	258
	0.25 ... 2.5 (4) mm ² (22 ... 12 AWG)		
	Double-Fuse Plugs on Carrier Terminal Blocks	2003 Series	262
	Multilevel Installation Terminal Blocks; with Operating Slot and Push-Button; with N-Disconnect Slide Link	2205 Series	246
	0.5 ... 4 (6) mm ² (20 ... 10 AWG)	2205 Series	254
	Multilevel Installation Terminal Blocks; with N-Disconnect Slide Links	2005 Series	264
	0.5 ... 4 (6) mm ² (20 ... 10 AWG)		
	N-Disconnect Terminal Blocks and Power Distribution Disconnect Terminal Blocks	2206/2216 Series	266
	0.5 ... 16 (25 "f-st") mm ² (20 ... 4 AWG)		
	N-Disconnect Terminal Blocks and Power Distribution Disconnect Terminal Blocks	2002/2006/2010/2016 Series	268
	0.5 ... 16 (25 "f-st") mm ² (20 ... 4 AWG)		
	Supply Terminal Blocks for Distribution Boxes	2016 Series	270
	0.5 ... 16 (25 "f-st") mm ² (20 ... 4 AWG)		
	Board Set	821 Series	272

Installation Rail-Mount Terminal Blocks TOPJOB® S

Installation

3



Inserting a conductor via push-in termination. Solid conductors with cross-sections from either one size above, or up to two sizes below, the rated cross-section can be simply pushed in – no tools needed.

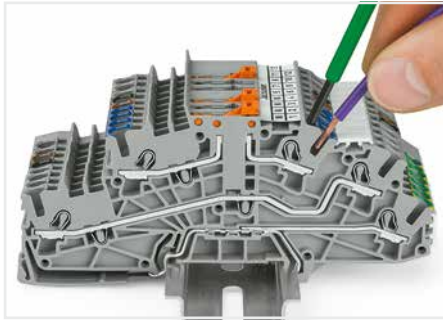

Inserting a conductor via operating tool. Connecting fine-stranded conductors without ferrules, or small cross-sectional conductors that cannot be pushed in, is performed similarly to the original CAGE CLAMP® – just use an operating tool.



All conductor types at a glance

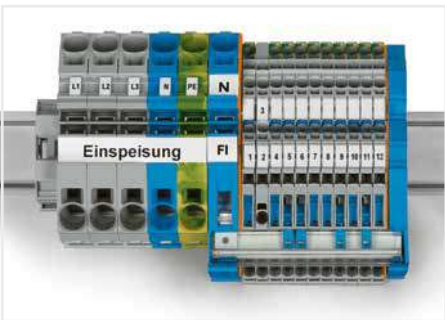

Mounting busbars on busbar carriers: Insert busbar ends onto large busbar carriers (2009-305) or onto supply terminal blocks with an integrated busbar carrier.



Removing the separator plate from the busbar carrier or from the N-disconnect terminal block.

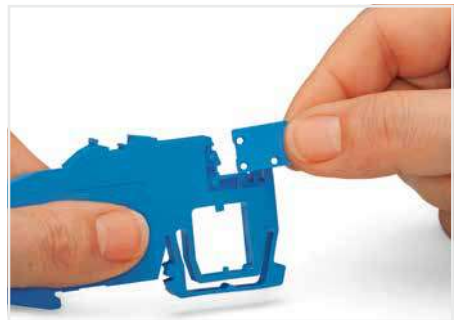

Inserting the separator plate into the busbar carrier to protect the N-busbar against accidental contact.



Inserting separator plate removed from N-disconnect terminal block.

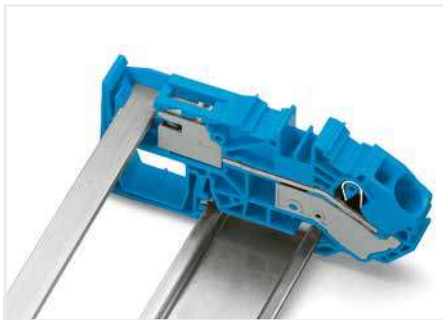

Touch-proof N-busbar via inserted separator plate

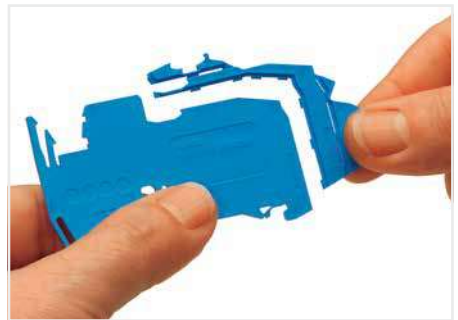

Perforations make it possible to fit the carrier to all Installation Rail-Mount Terminal Blocks TOPJOB® S using a single part.

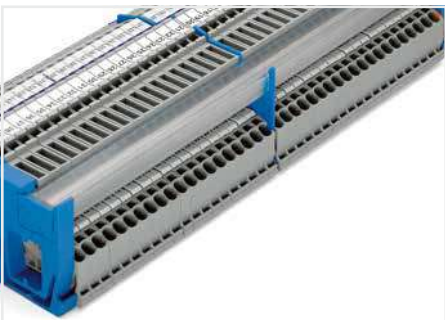

The compact busbar carrier (1.5 mm thick), which is placed every 200 mm, provides additional busbar support for longer assemblies.

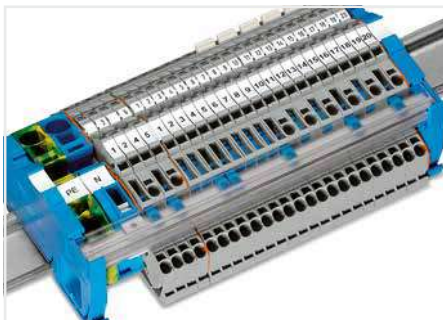

The busbar transparent cover (Item No. 777-303) protects the busbar against accidental contact and makes it easy to see which terminal blocks are connected to the busbar.

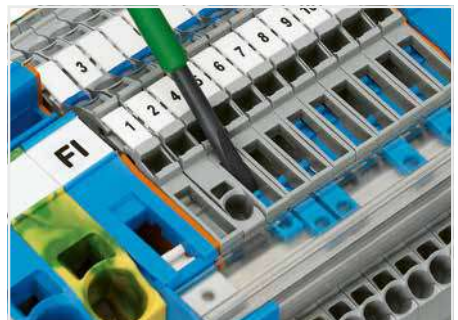

Operating a disconnect slide link with an operating tool (3.5 mm blade width)
Item number (operating tool): 2009-309, 2009-310, 210-658 or 210-720



Push-in CAGE CLAMP® terminates the following copper conductors:
solid "s"



stranded "st"



fine-stranded "f-st", also with tinned single strands



N-potential disconnection via N-knife disconnect within a terminal block assembly without a busbar.



For multilevel installation terminal blocks with internal N-disconnection, test plug adapters can be inserted into the free vertical test slot when the N-potential is disconnected.

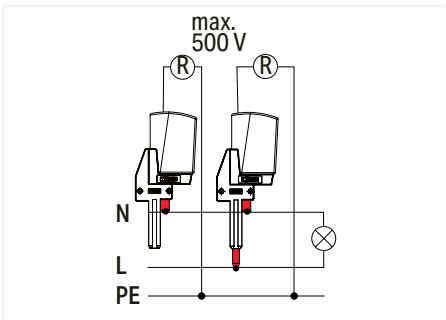

Test plug adapters for both individual N-potential measurement and insulation resistance measurement of the connected N- and L-potentials are available.

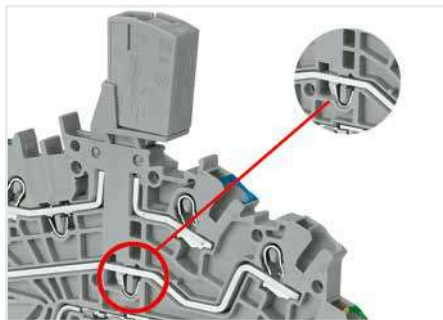

Multilevel installation terminal block fitted with an N/L-test plug adapter for quick and safe insulation resistance measurement of the connected N- and L-potentials

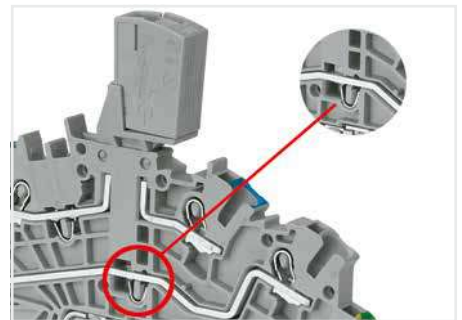

Multilevel installation terminal block fitted with an N-test plug adapter for insulation resistance measurement of the N-potential

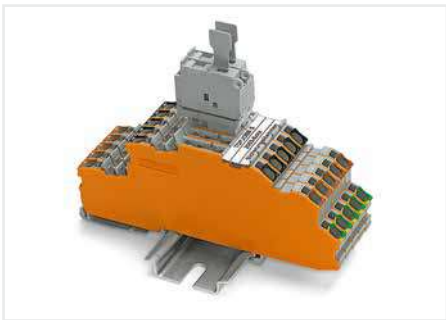

Single-fuse plugs can be used in combination with 1 mm thick end and intermediate plates on carrier terminal blocks without an N-knife disconnect.



Double-fuse plugs with 5 x 25 mm glass cartridge fuses can be used on carrier terminal blocks without an N-knife disconnect in standard terminal block width.

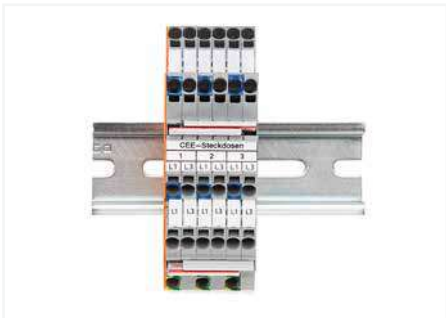

Commoning two potentials in one single jumper slot via extremely slim staggered jumpers.

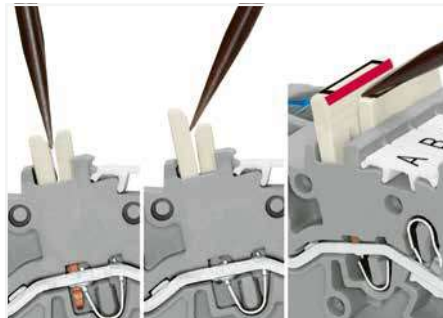

Insert the operating tool between the staggered jumpers, then lift up the jumper.



fine-stranded, tip-bonded



fine-stranded, with ferrule (gastight crimped)



fine-stranded, with pin terminal (gastight crimped)

Multilevel Installation Terminal Block TOPJOB® S; with Operating Slot and Push-Button; with N-Disconnect Slide Link 2.5 (4) mm²; 2203 Series

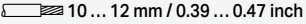
Technical Data	
0.25 ... 2.5 (4) mm ² ①	22 ... 12 AWG
250 V/4 kV/3; 24 A (29 A) ②	
400 V/6 kV/3; 24 A (29 A) ②	
Terminal block width: 5.2 mm / 0.205 inch	
 10 ... 12 mm / 0.39 ... 0.47 inch	

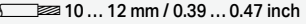
Technical Data	
0.25 ... 2.5 (4) mm ² ①	22 ... 12 AWG
400 V/6 kV/3 ②	
I _N 24 A (31 A)	
Terminal block width: 5.2 mm / 0.205 inch	
 10 ... 12 mm / 0.39 ... 0.47 inch	

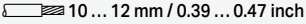
Technical Data	
0.25 ... 2.5 (4) mm ² ①	22 ... 12 AWG
250 V/4 kV/3; 24 A (31 A) ②	
400 V/6 kV/3; 24 A (31 A) ②	
Terminal block width: 5.2 mm / 0.205 inch	
 10 ... 12 mm / 0.39 ... 0.47 inch	

3

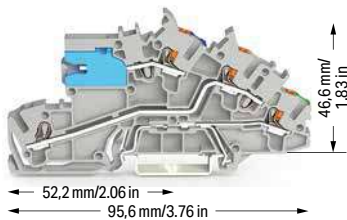

Multilevel installation terminal block; with operating slot and push-button; with N-disconnect slide link; gray

	Item No.	Pack. Unit
<input type="radio"/> NT/L/PE	2203-7541	50



Multilevel installation terminal block; with operating slot and push-button; gray

	Item No.	Pack. Unit
<input type="radio"/> L/L	2203-7542	50
<input type="radio"/> N/L	2203-7549	50

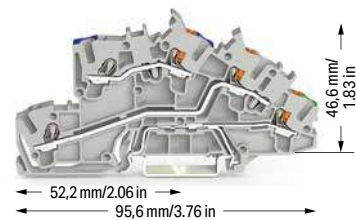

Multilevel installation terminal block; with operating slot and push-button; gray

	Item No.	Pack. Unit
<input type="radio"/> N/L/PE	2203-7546	50
<input type="radio"/> L/L/PE	2203-7545	50

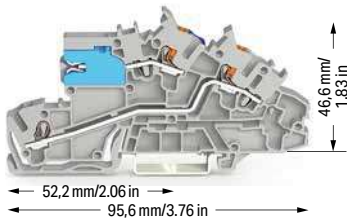

Multilevel installation terminal block; with operating slot and push-button; with N-disconnect slide link; gray

	Item No.	Pack. Unit
<input type="radio"/> NT/L	2203-7540	50
<input type="radio"/> LT/L	2203-7559	50



Multilevel installation terminal block; with operating slot and push-button; gray

	Item No.	Pack. Unit
<input type="radio"/> L	2203-7550	50
<input type="radio"/> N	2203-7551	50

Accessories; 2203 Series

Appropriate marking systems: WMB/WMB Inline/Marking strips

End and intermediate plate; 0.8 mm thick

	orange	2203-7692	100 (25)
--	--------	-----------	----------

Busbar carrier; not suitable as an end stop; snaps onto DIN-35 rail; 1.5 mm thick

	blue	2009-304	100 (25)
--	------	----------	----------

Busbar carrier; with end stop function and detachable separator plate; snaps onto DIN-35 rail; 7.5 mm thick

	blue	2009-305	25
--	------	----------	----

Busbar; tin-plated; 1000 mm long; copper (10 x 3) mm

	I _N 140 A	210-133	1
--	----------------------	---------	---

Busbar cover; 1000 mm long

	transparent	777-303	1
--	-------------	---------	---



1-conductor N-disconnect terminal block; I_N 76 A; 16 mm²; 12 mm wide

	blue	2016-7714	20
---	------	-----------	----



1-conductor N-disconnect terminal block; I_N 125 A; 35 mm²; 16 mm wide

	blue	785-613	15
---	------	---------	----

2-conductor supply terminal block for distribution boxes; I_N 76 A; 16 mm²; 12 mm wide

	gray	2016-7601	20
	blue	2016-7604	20

2-conductor through terminal block; I_N 125 A; 35 mm²; 16 mm wide

	gray	785-601	15
	blue	785-604	15

2-conductor ground terminal block; 16 mm²; 12 mm wide

	green-yellow	2016-7607	20
---	--------------	-----------	----

2-conductor ground terminal block; 35 mm²; 16 mm wide

	green-yellow	785-607	15
---	--------------	---------	----

Connector; for busbar; 2.5 ... 16 mm²

	blue	210-281	100 (50)
---	------	---------	----------

Connector; for busbar; 2.5 ... 35 mm²

	silver-colored	209-105	50
---	----------------	---------	----

Lock-out; prevents reclosing of slide link; snap-on type

	orange	2003-7300	100 (25)
---	--------	-----------	----------

Insulation stop; 5 pcs/strip; 0.25 ... 0.5 mm²

	light gray	2002-171	200 (25)
---	------------	----------	----------

Insulation stop; 5 pcs/strip; 0.75 ... 1 mm²

	dark gray	2002-172	200 (25)
---	-----------	----------	----------

❶ Conductor range: 0.25 ... 4 mm² "s+f-st"
 Push-in termination: 1 ... 4 mm² "s" and 1 ... 2.5 mm² "insulated ferrules, 12 mm"
 Depending on the conductor characteristic, a conductor with a smaller cross-section can also be inserted via push-in termination.

❷ 250 V / 400 V = rated voltage
 4 kV / 6 kV = rated impulse voltage
 3 = pollution degree (see Section 15)
 250 V/4 kV potential – ground
 400 V/6 kV potential – potential

Please observe the application notes:
 Jumpers, from page 182
 Testing accessories, page 181
 Marking, from page 684

Approvals and corresponding ratings, visit www.wago.com

Accessories; 2203 Series

Appropriate marking systems:
 WMB/WMB Inline/Marking strips

Push-in type jumper bar; insulated; I_N 25 A; light gray

	2-way	2002-402	25
	3-way	2002-403	25
	4-way	2002-404	25
	5-way	2002-405	25
	6-way	2002-406	25
	7-way	2002-407	25
	8-way	2002-408	25
	9-way	2002-409	25
	10-way	2002-410	25

Push-in type jumper bar; insulated; I_N 25 A; light gray

	1 to 3	2002-433	25
	1 to 4	2002-434	25
	1 to 5	2002-435	25
	1 to 6	2002-436	25
	1 to 7	2002-437	25
	1 to 8	2002-438	25
	1 to 9	2002-439	25
	1 to 10	2002-440	25

Staggered jumper; insulated; I_N 25 A; light gray

	2-way	2002-472	25
	3-way	2002-473	25
	4-way	2002-474	25
	5-way	2002-475	25
	6-way	2002-476	25
	7-way	2002-477	25
	8-way	2002-478	25
	9-way	2002-479	25
	10-way	2002-480	25
	11-way	2002-481	25
	12-way	2002-482	25

Customized staggered jumper; insulated; with contact lugs broken off at the factory and circuit printing; I_N 25 A; light gray

	1-3	2002-473/011-000	25
	1-3-5	2002-475/011-000	25
	1-3-5-7	2002-477/011-000	25
	1-3-5-7-9	2002-479/011-000	25
	1-3-5-7-9-11	2002-481/011-000	25

Continuous jumper; insulated; I_N 25 A; light gray

	2-way	2002-400	25
---	-------	----------	----

Continuous jumper; insulated; I_N 25 A; light gray

	1 to 3	2002-423	25
	1 to 4	2002-424	25

Accessories; 2203 Series

Appropriate marking systems:
 WMB/WMB Inline/Marking strips

Continuous jumper; insulated; I_N 25 A; light gray

	3-way	2002-413	25
	5-way	2002-415	25

Push-in type wire jumper; insulated; 1.5 mm² conductor cross-section; I_N 18 A

	L = 60 mm	2009-412	100 (10)
	L = 110 mm	2009-414	100 (10)
	L = 250 mm	2009-416	100 (10)

Test plug adapter; for 4 mm Ø test plug

	gray	2009-174	100 (25)
---	------	----------	----------

Testing tap; for max. 2.5 mm²

	gray	2009-182	100 (25)
---	------	----------	----------

Marking strip; plain; 11 mm wide; 50 m reel

	white	2009-110	1
---	-------	----------	---

WMB Inline; plain; 1,500 WMB markers (5 mm)/reel; stretchable 5 ... 5.2 mm

	white	2009-115	1
--	-------	----------	---

WMB marker card; white; 10 strips with 10 markers/card; stretchable 5 ... 5.2 mm

	plain	793-5501	5
---	-------	----------	---

Operating tool; 3.5 mm and 2.5 mm blade; for TOPJOB® S Installation Terminal Blocks

		2009-309	50 (1)
---	--	----------	--------

Operating tool; 3.5 mm and 5.5 mm blade; for TOPJOB® S Installation Terminal Blocks

		2009-310	50 (1)
---	--	----------	--------

Operating tool; (3.5 x 0.5) mm blade; with a partially insulated shaft

		210-720	1
---	--	---------	---

TOPJOB® S – Terminal Blocks for Every Application

- Push-in termination of solid conductors in small distribution boards saves time and money.
- Operating errors can be prevented as all TOPJOB® S Terminal Blocks for building installations are equipped with push-in connection technology.
- Using standard accessories reduces order processing and inventory costs.
- The busbar position is the same, making TOPJOB® S Installation Terminal Blocks compatible with standard TOPJOB® Installation Terminal Blocks.

For constructing and operating power installations in fire-prone, hazardous locations or public buildings – such as conference centers, stores, hospitals, schools, theaters or hotels – the DIN VDE 0100-710 or DIN VDE 0100-718 standards shall be observed. DIN VDE 0100-482 shall also be observed for fire-prone, hazardous locations. These VDE regulations mandate that every neutral conductor must be provided with a disconnection device so, e.g., insulation resistance measurement is possible for every circuit without disconnecting the N-conductor. WAGO's N-disconnect terminal blocks meet this requirement.

Application note:

N-disconnect slide links, used in installation terminal blocks, consist of switch contacts that are opened and then closed again as part of regular circuit testing. To guarantee a reliable connection, a corrosion-resistant contact area is required on the N-busbar.

Historically, uninsulated copper busbars that have been cleaned/stripped of any possible corrosion before install can be used in dry, pollution-free locations.

According to DIN VDE 0100-520 (VDE 0100, Part 520), installation equipment exposed to contamination or corrosive substances (e.g., water) that promote corrosion or deterioration must be protected or made of a corrosion- or wear-resistant material. In these cases, tinned copper busbars guarantee a reliable connection.

WAGO only offers tinned copper busbars.

Multilevel Installation Terminal Block TOPJOB® S; with Operating Slot and Push-Button; with Internal N-Disconnect

2.5 (4) mm²; 2203 Series

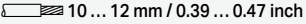
Technical Data	
0.25 ... 2.5 (4) mm ² ①	22 ... 12 AWG
250 V/4 kV/3; 22 A (27 A) ②	
400 V/6 kV/3; 22 A (27 A) ②	
Terminal block width: 5.2 mm / 0.205 inch	
 10 ... 12 mm / 0.39 ... 0.47 inch	

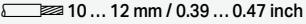
Technical Data	
0.25 ... 2.5 (4) mm ² ①	22 ... 12 AWG
400 V/6 kV/3 ②	
I _N 24 A (31 A)	
Terminal block width: 5.2 mm / 0.205 inch	
 10 ... 12 mm / 0.39 ... 0.47 inch	

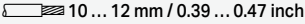
Technical Data	
0.25 ... 2.5 (4) mm ² ①	22 ... 12 AWG
250 V/4 kV/3; 24 A (31 A) ②	
400 V/6 kV/3; 24 A (31 A) ②	
Terminal block width: 5.2 mm / 0.205 inch	
 10 ... 12 mm / 0.39 ... 0.47 inch	

3

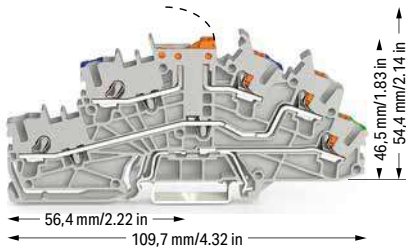

Multilevel installation terminal block; with operating slot and push-button; with pivoting knife disconnect; gray

	Item No.	Pack. Unit
<input type="radio"/> NT/L/PE	2203-6541	50
<input type="radio"/> LT/L/PE	2203-6544	50

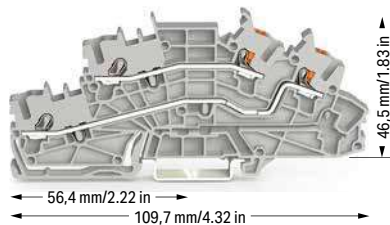

Multilevel installation terminal block; with operating slot and push-button; gray

	Item No.	Pack. Unit
<input type="radio"/> L/L	2203-6542	50
<input type="radio"/> N/L	2203-6549	50

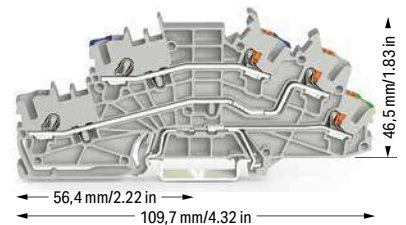

Multilevel installation terminal block; with operating slot and push-button; gray

	Item No.	Pack. Unit
<input type="radio"/> N/L/PE	2203-6546	50
<input type="radio"/> L/L/PE	2203-6545	50

Item-Specific Accessories

N/L-test plug adapter; for vertical test slot; gray

	2-pole	2003-499	100 (25)
--	--------	----------	----------

N-test plug adapter; for vertical test slot; gray

	1-pole	2003-500	100 (25)
---	--------	----------	----------

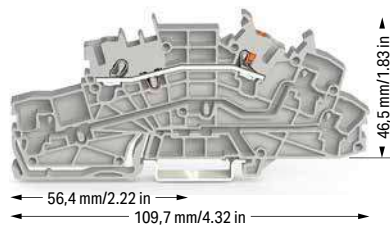

Multilevel installation terminal block; with operating slot and push-button; gray

	Item No.	Pack. Unit
<input type="radio"/> L	2203-6550	50
<input type="radio"/> N	2203-6551	50

Accessories; 2203 Series

Appropriate marking systems: WMB/WMB Inline/Marking strips

End and intermediate plate; 0.8 mm thick

	orange	2203-6692	100 (25)
--	--------	-----------	----------

Insulation stop; 5 pcs/strip; 0.25 ... 0.5 mm²

	light gray	2002-171	200 (25)
---	------------	----------	----------

Insulation stop; 5 pcs/strip; 0.75 ... 1 mm²

	dark gray	2002-172	200 (25)
---	-----------	----------	----------

Push-in type jumper bar; insulated; I_N 25 A; light gray

	2-way	2002-402	25
	3-way	2002-403	25
	4-way	2002-404	25
	5-way	2002-405	25
	6-way	2002-406	25
	7-way	2002-407	25
	8-way	2002-408	25
	9-way	2002-409	25
	10-way	2002-410	25

Push-in type jumper bar; insulated; I_N 25 A; light gray

	1 to 3	2002-433	25
	1 to 4	2002-434	25
	1 to 5	2002-435	25
	1 to 6	2002-436	25
	1 to 7	2002-437	25
	1 to 8	2002-438	25
	1 to 9	2002-439	25
	1 to 10	2002-440	25

Push-in type wire jumper; insulated; 1.5 mm² conductor cross-section; I_N 18 A

	L = 60 mm	2009-412	100 (10)
	L = 110 mm	2009-414	100 (10)
	L = 250 mm	2009-416	100 (10)

① Conductor range: 0.25 ... 4 mm² "s+f-st"
 Push-in termination: 1 ... 4 mm² "s" and 1 ... 2.5 mm² "insulated ferrules, 12 mm"
 Depending on the conductor characteristic, a conductor with a smaller cross-section can also be inserted via push-in termination.

② 250 V / 400 V = rated voltage
 4 kV / 6 kV = rated impulse voltage
 3 = pollution degree
 (see Section 15)
 250 V/4 kV potential – ground
 400 V/6 kV potential – potential

Please observe the application notes:
 Jumpers, from page 182
 Testing accessories, page 181
 Marking, from page 684

Approvals and corresponding ratings, visit www.wago.com

Accessories; 2203 Series

Appropriate marking systems:
 WMB/WMB Inline/Marking strips

Staggered jumper; insulated; I_N 25 A; light gray



2-way	2002-472	25
3-way	2002-473	25
4-way	2002-474	25
5-way	2002-475	25
6-way	2002-476	25
7-way	2002-477	25
8-way	2002-478	25
9-way	2002-479	25
10-way	2002-480	25
11-way	2002-481	25
12-way	2002-482	25

Customized staggered jumper; insulated; with contact lugs broken off at the factory and circuit printing; I_N 25 A; light gray



1-3	2002-473/011-000	25
1-3-5	2002-475/011-000	25
1-3-5-7	2002-477/011-000	25
1-3-5-7-9	2002-479/011-000	25
1-3-5-7-9-11	2002-481/011-000	25

Continuous jumper; insulated; I_N 25 A; light gray



1-2	2002-400	25
-----	----------	----

Continuous jumper; insulated; I_N 25 A; light gray



1 to 3	2002-423	25
1 to 4	2002-424	25

Continuous jumper; insulated; I_N 25 A; light gray



3-way	2002-413	25
5-way	2002-415	25

Test plug adapter; for 4 mm Ø test plug



gray	2009-174	100 (25)
------	----------	----------

Testing tap; for max. 2.5 mm²



gray	2009-182	100 (25)
------	----------	----------

Marking strip; plain; 11 mm wide; 50 m reel



white	2009-110	1
-------	----------	---

Accessories; 2203 Series

Appropriate marking systems:
 WMB/WMB Inline/Marking strips

WMB Inline; plain; 1,500 WMB markers (5 mm)/reel; stretchable 5 ... 5.2 mm



white	2009-115	1
-------	----------	---

WMB marker card; white; 10 strips with 10 markers/card; stretchable 5 ... 5.2 mm



plain	793-5501	5
-------	----------	---

Operating tool; 3.5 mm and 2.5 mm blade; for TOPJOB® S Installation Terminal Blocks



2009-309	50 (1)
----------	--------

Operating tool; 3.5 mm and 5.5 mm blade; for TOPJOB® S Installation Terminal Blocks



2009-310	50 (1)
----------	--------

Operating tool; (3.5 x 0.5) mm blade; with a partially insulated shaft



210-720	1
---------	---

Multilevel Installation Terminal Block TOPJOB® S; with Operating Slot and Push-Button 2.5 (4) mm²; 2203 Series

Technical Data

0.25 ... 2.5 (4) mm² ① | 22 ... 12 AWG
 250 V/4 kV/3; 22 A (27 A) ②
 400 V/6 kV/3; 22 A (27 A) ②
 Terminal block width: 5.2 mm / 0.205 inch
 10 ... 12 mm / 0.39 ... 0.47 inch

Technical Data

0.25 ... 2.5 (4) mm² ① | 22 ... 12 AWG
 250 V/4 kV/3; 22 A (27 A) ②
 400 V/6 kV/3; 22 A (27 A) ②
 Terminal block width: 5.2 mm / 0.205 inch
 10 ... 12 mm / 0.39 ... 0.47 inch

3

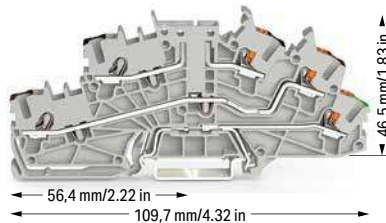
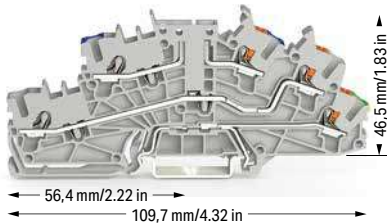

Multilevel installation terminal block; with operating slot and push-button; carrier terminal block without knife disconnect; gray

	Item No.	Pack. Unit
○ N/L/PE	2203-6540	50

Multilevel installation terminal block; with operating slot and push-button; carrier terminal block without knife disconnect; black upper-deck, brown middle-deck, green-yellow lower-deck printing

	Item No.	Pack. Unit
○ P2/P1/PE	2203-6543	50

Multilevel installation terminal block; carrier terminal block; with operating slot and push-button without knife disconnect; blue middle-deck; green-yellow lower-deck printing; gray

○ L/N/PE	2203-6561	50
----------	-----------	----

Multilevel installation terminal block; with operating slot and push-button; carrier terminal block without knife disconnect; brown upper-deck, black middle-deck, green-yellow lower-deck printing

○ P1/P2/PE	2203-6560	50
------------	-----------	----

Accessories; 2203 Series

Appropriate marking systems: WMB/WMB Inline/Marking strips

N/L-test plug adapter; for vertical test slot; gray

	2-pole	2003-499	100 (25)
---	--------	----------	----------

N-test plug adapter; for vertical test slot; gray

	1-pole	2003-500	100 (25)
---	--------	----------	----------

End and intermediate plate; 0.8 mm thick

	orange	2203-6692	100 (25)
--	--------	-----------	----------

Fuse plug with pull-tab; for (5 x 20) mm glass cartridge fuse Electrical ratings are given by the fuse.

	gray	2004-911	50
---	------	----------	----

End and intermediate plate; only for use with fuse plugs; 1 mm thick

	orange	2203-6693	100 (25)
--	--------	-----------	----------

Double-fuse plug; for (5 x 20) mm glass cartridge fuse Electrical ratings are given by the fuse.

	gray	2003-911	25
	gray	2003-911/1000-923	25

End and intermediate plate; 1 mm thick; only for use with double-fuse plugs

	orange	2203-6694	100 (25)
--	--------	-----------	----------

Push-in type jumper bar; insulated; I_N 25 A; light gray

	2-way	2002-402	25
	3-way	2002-403	25
	4-way	2002-404	25
	5-way	2002-405	25
	6-way	2002-406	25
	7-way	2002-407	25
	8-way	2002-408	25
	9-way	2002-409	25
	10-way	2002-410	25

Push-in type jumper bar; insulated; I_N 25 A; light gray

	1 to 3	2002-433	25
	1 to 4	2002-434	25
	1 to 5	2002-435	25
	1 to 6	2002-436	25
	1 to 7	2002-437	25
	1 to 8	2002-438	25
	1 to 9	2002-439	25
	1 to 10	2002-440	25

Continuous jumper; insulated; I_N 25 A; light gray

	1-2	2002-400	25
---	-----	----------	----

Continuous jumper; insulated; I_N 25 A; light gray

	1 to 3	2002-423	25
	1 to 4	2002-424	25

Continuous jumper; insulated; I_N 25 A; light gray

	3-way	2002-413	25
	5-way	2002-415	25

① Conductor range: 0.25 ... 4 mm² "s+f-st"
 Push-in termination: 1 ... 4 mm² "s" and 1 ... 2.5 mm² "insulated ferrules, 12 mm"
 Depending on the conductor characteristic, a conductor with a smaller cross-section can also be inserted via push-in termination.

② 250 V / 400 V = rated voltage
 4 kV / 6 kV = rated impulse voltage
 3 = pollution degree (see Section 15)
 250 V/4 kV potential – ground
 400 V/6 kV potential – potential
 Maximum current depends on accessories used.

Please observe the application notes:
 Jumpers, from page 182
 Testing accessories, page 181
 Marking, from page 684

Approvals and corresponding ratings, visit www.wago.com

Accessories; 2203 Series

Appropriate marking systems:
 WMB/WMB Inline/Marking strips

Staggered jumper; insulated; I_N 25 A; light gray

	2-way	2002-472	25
	3-way	2002-473	25
	4-way	2002-474	25
	5-way	2002-475	25
	6-way	2002-476	25
	7-way	2002-477	25
	8-way	2002-478	25
	9-way	2002-479	25
	10-way	2002-480	25
	11-way	2002-481	25
	12-way	2002-482	25

Customized staggered jumper; insulated; with contact lugs broken off at the factory and circuit printing; I_N 25 A; light gray

	1-3	2002-473/011-000	25
	1-3-5	2002-475/011-000	25
	1-3-5-7	2002-477/011-000	25
	1-3-5-7-9	2002-479/011-000	25
	1-3-5-7-9-11	2002-481/011-000	25

Push-in type wire jumper; insulated; 1.5 mm² conductor cross-section; I_N 18 A

	L = 60 mm	2009-412	100 (10)
	L = 110 mm	2009-414	100 (10)
	L = 250 mm	2009-416	100 (10)

Test plug adapter; for 4 mm Ø test plug

	gray	2009-174	100 (25)
---	------	----------	----------

Testing tap; for max. 2.5 mm²

	gray	2009-182	100 (25)
---	------	----------	----------

Marking strip; plain; 11 mm wide; 50 m reel

	white	2009-110	1
---	-------	----------	---

WMB Inline; plain; 1,500 WMB markers (5 mm)/reel; stretchable 5 ... 5.2 mm

	white	2009-115	1
---	-------	----------	---

WMB marker card; white; 10 strips with 10 markers/card; stretchable 5 ... 5.2 mm

	plain	793-5501	5
---	-------	----------	---

Accessories; 2203 Series

Appropriate marking systems:
WMB/WMB Inline/Marking strips

Operating tool; 3.5 mm and 2.5 mm blade; for TOPJOB® S
Installation Terminal Blocks



2009-309 50 (1)

Operating tool; 3.5 mm and 5.5 mm blade; for TOPJOB® S
Installation Terminal Blocks



2009-310 50 (1)

Operating tool; (3.5 x 0.5) mm blade; with a partially
insulated shaft





210-720 1

Multilevel Installation Terminal Block TOPJOB® S; with Operating Slot and Push-Button; with N-Disconnect Slide Link

4 (6) mm²; 2205 Series

Technical Data	
0.5 ... 4 (6) mm ² ①	20 ... 10 AWG
250 V/4 kV/3; 31 A (35 A) ②	
400 V/6 kV/3; 31 A (35 A) ②	
Terminal block width: 6.2 mm / 0.244 inch	
 11 ... 13 mm / 0.43 ... 0.51 inch	

Technical Data	
0.5 ... 4 (6) mm ² ①	20 ... 10 AWG
400 V/6 kV/3 ②	
I _N 32 A (40 A)	
Terminal block width: 6.2 mm / 0.244 inch	
 11 ... 13 mm / 0.43 ... 0.51 inch	

Technical Data	
0.5 ... 4 (6) mm ² ①	20 ... 10 AWG
250 V/4 kV/3; 32 A (40 A) ②	
400 V/6 kV/3; 32 A (40 A) ②	
Terminal block width: 6.2 mm / 0.244 inch	
 11 ... 13 mm / 0.43 ... 0.51 inch	

3

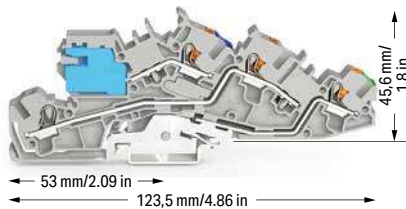

Multilevel installation terminal block; with operating slot and push-button; with N-disconnect slide link; gray

	Item No.	Pack. Unit
○ NT/L/PE	2205-7541	50

Multilevel installation terminal block; with operating slot and push-button; gray

	Item No.	Pack. Unit
○ L/L	2205-7542	50
○ N/L	2205-7549	50

Multilevel installation terminal block; with operating slot and push-button; gray

	Item No.	Pack. Unit
○ N/L/PE	2205-7546	50
○ L/L/PE	2205-7545	50

Accessories; 2205 Series

Appropriate marking systems: WMB/Marking strips

End and intermediate plate; 1 mm thick

 orange	2205-7692	100 (25)
--	-----------	----------

Busbar carrier; not suitable as an end stop; snaps onto DIN-35 rail; 1.5 mm thick

 blue	2009-304	100 (25)
---	----------	----------

Busbar carrier; with end stop function and detachable separator plate; snaps onto DIN-35 rail; 7.5 mm thick

 blue	2009-305	25
---	----------	----

Busbar; tin-plated; 1000 mm long; copper (10 x 3) mm

 I _N 140 A	210-133	1
---	---------	---

Busbar cover; 1000 mm long

 transparent	777-303	1
--	---------	---

1-conductor N-disconnect terminal block; I_N 76 A; 16 mm²; 12 mm wide

 blue	2016-7714	20
---	-----------	----

1-conductor N-disconnect terminal block; I_N 125 A; 35 mm²; 16 mm wide

 blue	785-613	15
---	---------	----

2-conductor supply terminal block for distribution boxes; I_N 76 A; 16 mm²; 12 mm wide

 gray	2016-7601	20
 blue	2016-7604	20

2-conductor through terminal block; I_N 125 A; 35 mm²; 16 mm wide

 gray	785-601	15
 blue	785-604	15

2-conductor ground terminal block; 16 mm²; 12 mm wide

 green-yellow	2016-7607	20
---	-----------	----

2-conductor ground terminal block; 35 mm²; 16 mm wide

 green-yellow	785-607	15
--	---------	----

Connector; for busbar; 2.5 ... 16 mm²

 blue	210-281	100 (50)
--	---------	----------

Connector; for busbar; 2.5 ... 35 mm²

 silver-colored	209-105	50
--	---------	----

Lock-out; prevents reclosing of slide link; snap-on type

 orange	2005-7300	100 (25)
--	-----------	----------



Insulation stop; 5 pcs/strip; 0.25 ... 0.5 mm²

 light gray	2004-171	200 (25)
--	----------	----------







Insulation stop; 5 pcs/strip; 0.75 ... 1 mm²

 dark gray	2004-172	200 (25)
---	----------	----------

Push-in type jumper bar; insulated; I_N 32 A; light gray

 2-way	2004-402	25
 3-way	2004-403	25
 4-way	2004-404	25
 5-way	2004-405	25
 6-way	2004-406	25
 7-way	2004-407	25
 8-way	2004-408	25
 9-way	2004-409	25
 10-way	2004-410	25

Push-in type jumper bar; insulated; I_N 32 A; light gray

 1 to 3	2004-433	25
 1 to 4	2004-434	25
 1 to 5	2004-435	25
 1 to 6	2004-436	25
 1 to 7	2004-437	25
 1 to 8	2004-438	25
 1 to 9	2004-439	25
 1 to 10	2004-440	25

Test plug adapter; for 4 mm Ø test plug

 gray	2009-174	100 (25)
--	----------	----------

Testing tap; for max. 2.5 mm²

 gray	2009-182	100 (25)
--	----------	----------

Marking strip; plain; 11 mm wide; 50 m reel

 white	2009-110	1
---	----------	---

WMB marker card; white; 10 strips with 10 markers/card; stretchable 5 ... 5.2 mm

 plain	793-5501	5
---	----------	---

Operating tool; 3.5 mm and 2.5 mm blade; for TOPJOB® S Installation Terminal Blocks

 2009-309	50 (1)
--	--------

Operating tool; 3.5 mm and 5.5 mm blade; for TOPJOB® S Installation Terminal Blocks

 2009-310	50 (1)
--	--------

Operating tool; (3.5 x 0.5) mm blade; with a partially insulated shaft

 210-720	1
---	---

① Conductor range: 0.5 ... 6 mm² "s+f-st"
 Push-in termination: 1.5 ... 6 mm² "s" and 1.5 ... 4 mm² "insulated ferrules, 12 mm"
 Depending on the conductor characteristic, a conductor with a smaller cross-section can also be inserted via push-in termination.

② 250 V / 400 V = rated voltage
 4 kV / 6 kV = rated impulse voltage
 3 = pollution degree
 (see Section 15)
 250 V/4 kV potential – ground
 400 V/6 kV potential – potential

Please observe the application notes:
 Testing accessories, page 181
 Marking, from page 684

Approvals and corresponding ratings,
 visit www.wago.com

Application note:

N-disconnect slide links, used in installation terminal blocks, consist of switch contacts that are opened and then closed again as part of regular circuit testing. To guarantee a reliable connection, a corrosion-resistant contact area is required on the N-busbar.

Historically, uninsulated copper busbars that have been cleaned/stripped of any possible corrosion before install can be used in dry, pollution-free locations.

According to DIN VDE 0100-520 (VDE 0100, Part 520), installation equipment exposed to contamination or corrosive substances (e.g., water) that promote corrosion or deterioration must be protected or made of a corrosion- or wear-resistant material. In these cases, tinned copper busbars guarantee a reliable connection.

WAGO only offers tinned copper busbars.

Multilevel Installation Terminal Block TOPJOB® S; with Push-Button; with N-Disconnect Slide Link

2.5 (4) mm²; 2203 Series

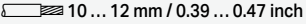
Technical Data	
0.25 ... 2.5 (4) mm ² ①	22 ... 12 AWG
250 V/4 kV/3; 24 A (29 A) ②	
400 V/6 kV/3; 24 A (29 A) ②	
Terminal block width: 5.2 mm / 0.205 inch	
 10 ... 12 mm / 0.39 ... 0.47 inch	

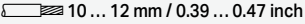
Technical Data	
0.25 ... 2.5 (4) mm ² ①	22 ... 12 AWG
400 V/6 kV/3 ②	
I _N 24 A (31 A)	
Terminal block width: 5.2 mm / 0.205 inch	
 10 ... 12 mm / 0.39 ... 0.47 inch	

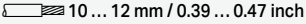
Technical Data	
0.25 ... 2.5 (4) mm ² ①	22 ... 12 AWG
250 V/4 kV/3; 24 A (31 A) ②	
400 V/6 kV/3; 24 A (31 A) ②	
Terminal block width: 5.2 mm / 0.205 inch	
 10 ... 12 mm / 0.39 ... 0.47 inch	

3

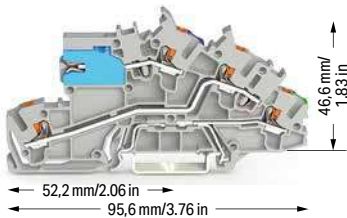

Multilevel installation terminal block; with push-button; with N-disconnect slide link; gray

	Item No.	Pack. Unit
<input type="radio"/> NT/L/PE	2203-7641	50



Multilevel installation terminal block; with push-button; gray

	Item No.	Pack. Unit
<input type="radio"/> L/L	2203-7642	50
<input type="radio"/> N/L	2203-7649	50



Multilevel installation terminal block; with push-button; gray

	Item No.	Pack. Unit
<input type="radio"/> N/L/PE	2203-7646	50
<input type="radio"/> L/L/PE	2203-7645	50

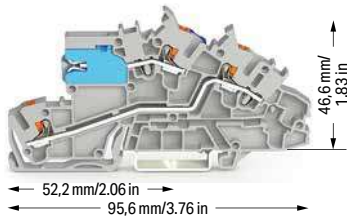

Multilevel installation terminal block; with push-button; with N-disconnect slide link; gray

	Item No.	Pack. Unit
<input type="radio"/> NT/L	2203-7640	50
<input type="radio"/> LT/L	2203-7659	50



Multilevel installation terminal block; with push-button; gray

	Item No.	Pack. Unit
<input type="radio"/> L	2203-7650	50
<input type="radio"/> N	2203-7651	50

Accessories; 2203 Series

Appropriate marking systems: WMB/WMB Inline/Marking strips

End and intermediate plate; 0.8 mm thick

	orange	2203-7692	100 (25)
--	--------	-----------	----------

Busbar carrier; not suitable as an end stop; snaps onto DIN-35 rail; 1.5 mm thick

	blue	2009-304	100 (25)
--	------	----------	----------

Busbar carrier; with end stop function and detachable separator plate; snaps onto DIN-35 rail; 7.5 mm thick

	blue	2009-305	25
--	------	----------	----

Busbar; tin-plated; 1000 mm long; copper (10 x 3) mm

	I _N 140 A	210-133	1
--	----------------------	---------	---

Busbar cover; 1000 mm long

	transparent	777-303	1
--	-------------	---------	---



1-conductor N-disconnect terminal block; I_N 76 A; 16 mm²; 12 mm wide

	blue	2016-7714	20
---	------	-----------	----



1-conductor N-disconnect terminal block; I_N 125 A; 35 mm²; 16 mm wide

	blue	785-613	15
---	------	---------	----

2-conductor supply terminal block for distribution boxes; I_N 76 A; 16 mm²; 12 mm wide

	gray	2016-7601	20
	blue	2016-7604	20

2-conductor through terminal block; I_N 125 A; 35 mm²; 16 mm wide

	gray	785-601	15
	blue	785-604	15

2-conductor ground terminal block; 16 mm²; 12 mm wide

	green-yellow	2016-7607	20
---	--------------	-----------	----

2-conductor ground terminal block; 35 mm²; 16 mm wide

	green-yellow	785-607	15
---	--------------	---------	----

Connector; for busbar; 2.5 ... 16 mm²

	blue	210-281	100 (50)
---	------	---------	----------

Connector; for busbar; 2.5 ... 35 mm²

	silver-colored	209-105	50
---	----------------	---------	----

Lock-out; prevents reclosing of slide link; snap-on type

	orange	2003-7300	100 (25)
---	--------	-----------	----------

Insulation stop; 5 pcs/strip; 0.25 ... 0.5 mm²

	light gray	2002-171	200 (25)
---	------------	----------	----------

Insulation stop; 5 pcs/strip; 0.75 ... 1 mm²

	dark gray	2002-172	200 (25)
---	-----------	----------	----------

① Conductor range: 0.25 ... 4 mm² "s+f-st"
Push-in termination: 1 ... 4 mm² "s" and 1 ... 2.5 mm² "insulated ferrules, 12 mm"
Depending on the conductor characteristic, a conductor with a smaller cross-section can also be inserted via push-in termination.

② 250 V / 400 V = rated voltage
4 kV / 6 kV = rated impulse voltage
3 = pollution degree (see Section 15)
250 V/4 kV potential – ground
400 V/6 kV potential – potential

Please observe the application notes:
Jumpers, from page 182
Testing accessories, page 181
Marking, from page 684

Approvals and corresponding ratings, visit www.wago.com

Accessories; 2203 Series

Appropriate marking systems:
WMB/WMB Inline/Marking strips

Push-in type jumper bar; insulated; I_N 25 A; light gray

	2-way	2002-402	25
	3-way	2002-403	25
	4-way	2002-404	25
	5-way	2002-405	25
	6-way	2002-406	25
	7-way	2002-407	25
	8-way	2002-408	25
	9-way	2002-409	25
	10-way	2002-410	25

Push-in type jumper bar; insulated; I_N 25 A; light gray

	1 to 3	2002-433	25
	1 to 4	2002-434	25
	1 to 5	2002-435	25
	1 to 6	2002-436	25
	1 to 7	2002-437	25
	1 to 8	2002-438	25
	1 to 9	2002-439	25
	1 to 10	2002-440	25

Staggered jumper; insulated; I_N 25 A; light gray

	2-way	2002-472	25
	3-way	2002-473	25
	4-way	2002-474	25
	5-way	2002-475	25
	6-way	2002-476	25
	7-way	2002-477	25
	8-way	2002-478	25
	9-way	2002-479	25
	10-way	2002-480	25
	11-way	2002-481	25
	12-way	2002-482	25

Customized staggered jumper; insulated; with contact lugs broken off at the factory and circuit printing; I_N 25 A; light gray

	1-3	2002-473/011-000	25
	1-3-5	2002-475/011-000	25
	1-3-5-7	2002-477/011-000	25
	1-3-5-7-9	2002-479/011-000	25
	1-3-5-7-9-11	2002-481/011-000	25

Continuous jumper; insulated; I_N 25 A; light gray

	1-2	2002-400	25
---	-----	----------	----

Continuous jumper; insulated; I_N 25 A; light gray

	1 to 3	2002-423	25
	1 to 4	2002-424	25

Accessories; 2203 Series

Appropriate marking systems:
WMB/WMB Inline/Marking strips

Continuous jumper; insulated; I_N 25 A; light gray

	3-way	2002-413	25
	5-way	2002-415	25

Push-in type wire jumper; insulated; 1.5 mm² conductor cross-section; I_N 18 A

	L = 60 mm	2009-412	100 (10)
	L = 110 mm	2009-414	100 (10)
	L = 250 mm	2009-416	100 (10)

Test plug adapter; for 4 mm Ø test plug

	gray	2009-174	100 (25)
---	------	----------	----------

Testing tap; for max. 2.5 mm²

	gray	2009-182	100 (25)
---	------	----------	----------

Marking strip; plain; 11 mm wide; 50 m reel

	white	2009-110	1
---	-------	----------	---

WMB Inline; plain; 1,500 WMB markers (5 mm)/reel; stretchable 5 ... 5.2 mm

	white	2009-115	1
--	-------	----------	---

WMB marker card; white; 10 strips with 10 markers/card; stretchable 5 ... 5.2 mm

	plain	793-5501	5
---	-------	----------	---

Operating tool; 3.5 mm and 2.5 mm blade; for TOPJOB® S Installation Terminal Blocks

		2009-309	50 (1)
---	--	----------	--------

Operating tool; 3.5 mm and 5.5 mm blade; for TOPJOB® S Installation Terminal Blocks

		2009-310	50 (1)
---	--	----------	--------

Operating tool; (3.5 x 0.5) mm blade; with a partially insulated shaft

		210-720	1
---	--	---------	---

TOPJOB® S – Terminal Blocks for Every Application

- Push-in termination of solid conductors in small distribution boards saves time and money.
- Operating errors can be prevented as all TOPJOB® S Terminal Blocks for building installations are equipped with push-in connection technology.
- Using standard accessories reduces order processing and inventory costs.
- The busbar position is the same, making TOPJOB® S Installation Terminal Blocks compatible with standard TOPJOB® Installation Terminal Blocks.

For constructing and operating power installations in fire-prone, hazardous locations or public buildings – such as conference centers, stores, hospitals, schools, theaters or hotels – the DIN VDE 0100-710 or DIN VDE 0100-718 standards shall be observed. DIN VDE 0100-482 shall also be observed for fire-prone, hazardous locations. These VDE regulations mandate that every neutral conductor must be provided with a disconnection device so, e.g., insulation resistance measurement is possible for every circuit without disconnecting the N-conductor. WAGO's N-disconnect terminal blocks meet this requirement.

Application note:

N-disconnect slide links, used in installation terminal blocks, consist of switch contacts that are opened and then closed again as part of regular circuit testing. To guarantee a reliable connection, a corrosion-resistant contact area is required on the N-busbar.

Historically, uninsulated copper busbars that have been cleaned/stripped of any possible corrosion before install can be used in dry, pollution-free locations.

According to DIN VDE 0100-520 (VDE 0100, Part 520), installation equipment exposed to contamination or corrosive substances (e.g., water) that promote corrosion or deterioration must be protected or made of a corrosion- or wear-resistant material. In these cases, tinned copper busbars guarantee a reliable connection.

WAGO only offers tinned copper busbars.

Multilevel Installation Terminal Block TOPJOB® S; with Push-Button; with Internal N-Disconnect 2.5 (4) mm²; 2203 Series

Technical Data	
0.25 ... 2.5 (4) mm ² ①	22 ... 12 AWG
250 V/4 kV/3; 22 A (27 A) ②	
400 V/6 kV/3; 22 A (27 A) ②	
Terminal block width: 5.2 mm / 0.205 inch	
 10 ... 12 mm / 0.39 ... 0.47 inch	

Technical Data	
0.25 ... 2.5 (4) mm ² ①	22 ... 12 AWG
400 V/6 kV/3 ②	
I _N 24 A (31 A)	
Terminal block width: 5.2 mm / 0.205 inch	
 10 ... 12 mm / 0.39 ... 0.47 inch	

Technical Data	
0.25 ... 2.5 (4) mm ² ①	22 ... 12 AWG
250 V/4 kV/3; 24 A (31 A) ②	
400 V/6 kV/3; 24 A (31 A) ②	
Terminal block width: 5.2 mm / 0.205 inch	
 10 ... 12 mm / 0.39 ... 0.47 inch	

3

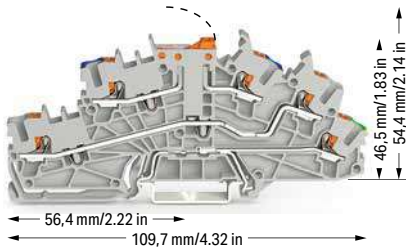

Multilevel installation terminal block; with push-button; with pivoting knife disconnect; gray

	Item No.	Pack. Unit
<input type="radio"/> NT/L/PE	2203-6641	50
<input type="radio"/> LT/L/PE	2203-6644	50

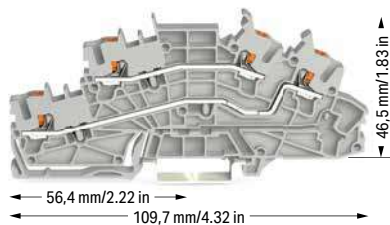

Multilevel installation terminal block; with push-button; gray

	Item No.	Pack. Unit
<input type="radio"/> L/L	2203-6642	50
<input type="radio"/> N/L	2203-6649	50

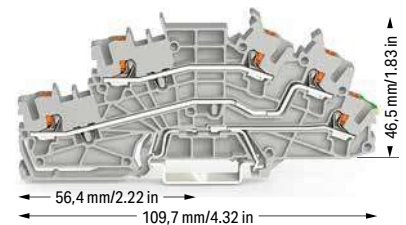

Multilevel installation terminal block; with push-button; gray

	Item No.	Pack. Unit
<input type="radio"/> N/L/PE	2203-6646	50
<input type="radio"/> L/L/PE	2203-6645	50

Item-Specific Accessories

N/L-test plug adapter; for vertical test slot; gray

	2-pole	2003-499	100 (25)
--	--------	----------	----------

N-test plug adapter; for vertical test slot; gray

	1-pole	2003-500	100 (25)
---	--------	----------	----------

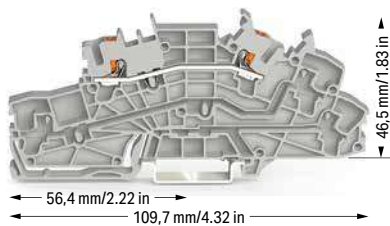

Multilevel installation terminal block; with push-button; gray

	Item No.	Pack. Unit
<input type="radio"/> L	2203-6650	50
<input type="radio"/> N	2203-6651	50

Accessories; 2203 Series

Appropriate marking systems: WMB/WMB Inline/Marking strips

End and intermediate plate; 0.8 mm thick

	orange	2203-6692	100 (25)
--	--------	-----------	----------

Insulation stop; 5 pcs/strip; 0.25 ... 0.5 mm²

	light gray	2002-171	200 (25)
--	------------	----------	----------

Insulation stop; 5 pcs/strip; 0.75 ... 1 mm²

	dark gray	2002-172	200 (25)
--	-----------	----------	----------

Push-in type jumper bar; insulated; I_N 25 A; light gray

	2-way	2002-402	25
	3-way	2002-403	25
	4-way	2002-404	25
	5-way	2002-405	25
	6-way	2002-406	25
	7-way	2002-407	25
	8-way	2002-408	25
	9-way	2002-409	25
	10-way	2002-410	25

Push-in type jumper bar; insulated; I_N 25 A; light gray

	1 to 3	2002-433	25
	1 to 4	2002-434	25
	1 to 5	2002-435	25
	1 to 6	2002-436	25
	1 to 7	2002-437	25
	1 to 8	2002-438	25
	1 to 9	2002-439	25
	1 to 10	2002-440	25

Push-in type wire jumper; insulated; 1.5 mm² conductor cross-section; I_N 18 A

	L = 60 mm	2009-412	100 (10)
	L = 110 mm	2009-414	100 (10)
	L = 250 mm	2009-416	100 (10)

① Conductor range: 0.25 ... 4 mm² "s+f-st"
Push-in termination: 1 ... 4 mm² "s" and 1 ... 2.5 mm² "insulated ferrules, 12 mm"
Depending on the conductor characteristic, a conductor with a smaller cross-section can also be inserted via push-in termination.

② 250 V / 400 V = rated voltage
4 kV / 6 kV = rated impulse voltage
3 = pollution degree
(see Section 15)
250 V/4 kV potential – ground
400 V/6 kV potential – potential

Please observe the application notes:
Jumpers, from page 182
Testing accessories, page 181
Marking, from page 684

Approvals and corresponding ratings,
visit www.wago.com

Accessories; 2203 Series

Appropriate marking systems:
WMB/WMB Inline/Marking strips

Staggered jumper; insulated; I_N 25 A; light gray



2-way	2002-472	25
3-way	2002-473	25
4-way	2002-474	25
5-way	2002-475	25
6-way	2002-476	25
7-way	2002-477	25
8-way	2002-478	25
9-way	2002-479	25
10-way	2002-480	25
11-way	2002-481	25
12-way	2002-482	25

Customized staggered jumper; insulated; with contact lugs broken off at the factory and circuit printing; I_N 25 A; light gray



1-3	2002-473/011-000	25
1-3-5	2002-475/011-000	25
1-3-5-7	2002-477/011-000	25
1-3-5-7-9	2002-479/011-000	25
1-3-5-7-9-11	2002-481/011-000	25

Continuous jumper; insulated; I_N 25 A; light gray



1-2	2002-400	25
-----	----------	----

Continuous jumper; insulated; I_N 25 A; light gray



1 to 3	2002-423	25
1 to 4	2002-424	25

Continuous jumper; insulated; I_N 25 A; light gray



3-way	2002-413	25
5-way	2002-415	25

Test plug adapter; for 4 mm Ø test plug



gray	2009-174	100 (25)
------	----------	----------

Testing tap; for max. 2.5 mm²



gray	2009-182	100 (25)
------	----------	----------

Marking strip; plain; 11 mm wide; 50 m reel



white	2009-110	1
-------	----------	---

Accessories; 2203 Series

Appropriate marking systems:
WMB/WMB Inline/Marking strips

WMB Inline; plain; 1,500 WMB markers (5 mm)/reel;
stretchable 5 ... 5.2 mm



white	2009-115	1
-------	----------	---

WMB marker card; white; 10 strips with 10 markers/card;
stretchable 5 ... 5.2 mm



plain	793-5501	5
-------	----------	---

Operating tool; 3.5 mm and 2.5 mm blade; for TOPJOB® S
Installation Terminal Blocks



2009-309	50 (1)
----------	--------

Operating tool; 3.5 mm and 5.5 mm blade; for TOPJOB® S
Installation Terminal Blocks



2009-310	50 (1)
----------	--------

Operating tool; (3.5 x 0.5) mm blade; with a partially
insulated shaft



210-720	1
---------	---

Multilevel Installation Terminal Block TOPJOB® S; with Push-Button 2.5 (4) mm²; 2203 Series

Technical Data

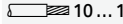
0.25 ... 2.5 (4) mm² ① | 22 ... 12 AWG
 250 V/4 kV/3; 22 A (27 A) ②
 400 V/6 kV/3; 22 A (27 A) ②
 Terminal block width: 5.2 mm / 0.205 inch
 10 ... 12 mm / 0.39 ... 0.47 inch

Technical Data

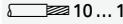
0.25 ... 2.5 (4) mm² ① | 22 ... 12 AWG
 250 V/4 kV/3; 22 A (27 A) ②
 400 V/6 kV/3; 22 A (27 A) ②
 Terminal block width: 5.2 mm / 0.205 inch
 10 ... 12 mm / 0.39 ... 0.47 inch

3

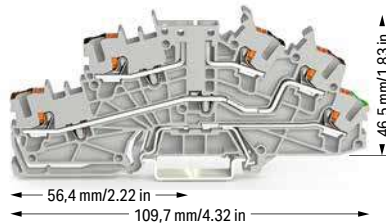
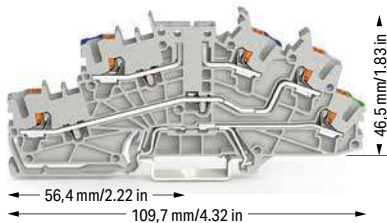

Multilevel installation terminal block; with push-button; carrier terminal block without knife disconnect; gray

	Item No.	Pack. Unit
○ N/L/PE	2203-6640	50

Multilevel installation terminal block; carrier terminal block; with push-button without knife disconnect; blue middle-deck; green-yellow lower-deck printing; gray

○ L/N/PE	2203-6661	50
----------	-----------	----

Multilevel installation terminal block; with push-button; carrier terminal block without knife disconnect; black upper-deck, brown middle-deck, green-yellow lower-deck printing

	Item No.	Pack. Unit
○ P2/P1/PE	2203-6643	50

Multilevel installation terminal block; with push-button; carrier terminal block without knife disconnect; brown upper-deck, black middle-deck, green-yellow lower-deck printing

○ P1/P2/PE	2203-6660	50
------------	-----------	----

Accessories; 2203 Series

Appropriate marking systems: WMB/WMB Inline/Marking strips

N/L-test plug adapter; for vertical test slot; gray

	2-pole	2003-499	100 (25)
---	--------	----------	----------

N-test plug adapter; for vertical test slot; gray

	1-pole	2003-500	100 (25)
---	--------	----------	----------

End and intermediate plate; 0.8 mm thick

	orange	2203-6692	100 (25)
--	--------	-----------	----------

Fuse plug with pull-tab; for (5 x 20) mm glass cartridge fuse Electrical ratings are given by the fuse.

	gray	2004-911	50
---	------	----------	----

End and intermediate plate; only for use with fuse plugs; 1 mm thick

	orange	2203-6693	100 (25)
--	--------	-----------	----------

Double-fuse plug; for (5 x 20) mm glass cartridge fuse Electrical ratings are given by the fuse.

	gray	2003-911	25
---	------	----------	----

End and intermediate plate; 1 mm thick; only for use with double-fuse plugs

	orange	2203-6694	100 (25)
--	--------	-----------	----------

Push-in type jumper bar; insulated; I_N 25 A; light gray

	2-way	2002-402	25
	3-way	2002-403	25
	4-way	2002-404	25
	5-way	2002-405	25
	6-way	2002-406	25
	7-way	2002-407	25
	8-way	2002-408	25
	9-way	2002-409	25
	10-way	2002-410	25

Push-in type jumper bar; insulated; I_N 25 A; light gray

	1 to 3	2002-433	25
	1 to 4	2002-434	25
	1 to 5	2002-435	25
	1 to 6	2002-436	25
	1 to 7	2002-437	25
	1 to 8	2002-438	25
	1 to 9	2002-439	25
	1 to 10	2002-440	25

Continuous jumper; insulated; I_N 25 A; light gray

	1-2	2002-400	25
---	-----	----------	----

Continuous jumper; insulated; I_N 25 A; light gray

	1 to 3	2002-423	25
	1 to 4	2002-424	25

Continuous jumper; insulated; I_N 25 A; light gray

	3-way	2002-413	25
	5-way	2002-415	25

① Conductor range: 0.25 ... 4 mm² "s+f-st"
 Push-in termination: 1 ... 4 mm² "s" and 1 ... 2.5 mm² "insulated ferrules, 12 mm"
 Depending on the conductor characteristic, a conductor with a smaller cross-section can also be inserted via push-in termination.

② 250 V / 400 V = rated voltage
 4 kV / 6 kV = rated impulse voltage
 3 = pollution degree (see Section 15)
 250 V/4 kV potential – ground
 400 V/6 kV potential – potential
 Maximum current depends on accessories used.

Please observe the application notes:
 Jumpers, from page 182
 Testing accessories, page 181
 Marking, from page 684

Approvals and corresponding ratings, visit www.wago.com

Accessories; 2203 Series

Appropriate marking systems:
 WMB/WMB Inline/Marking strips

Staggered jumper; insulated; I_N 25 A; light gray

	2-way	2002-472	25
	3-way	2002-473	25
	4-way	2002-474	25
	5-way	2002-475	25
	6-way	2002-476	25
	7-way	2002-477	25
	8-way	2002-478	25
	9-way	2002-479	25
	10-way	2002-480	25
	11-way	2002-481	25
	12-way	2002-482	25

Customized staggered jumper; insulated; with contact lugs broken off at the factory and circuit printing; I_N 25 A; light gray

	1-3	2002-473/011-000	25
	1-3-5	2002-475/011-000	25
	1-3-5-7	2002-477/011-000	25
	1-3-5-7-9	2002-479/011-000	25
	1-3-5-7-9-11	2002-481/011-000	25

Push-in type wire jumper; insulated; 1.5 mm² conductor cross-section; I_N 18 A

	L = 60 mm	2009-412	100 (10)
	L = 110 mm	2009-414	100 (10)
	L = 250 mm	2009-416	100 (10)

Test plug adapter; for 4 mm Ø test plug

	gray	2009-174	100 (25)
---	------	----------	----------

Testing tap; for max. 2.5 mm²

	gray	2009-182	100 (25)
---	------	----------	----------

Marking strip; plain; 11 mm wide; 50 m reel

	white	2009-110	1
---	-------	----------	---

WMB Inline; plain; 1,500 WMB markers (5 mm)/reel; stretchable 5 ... 5.2 mm

	white	2009-115	1
---	-------	----------	---

WMB marker card; white; 10 strips with 10 markers/card; stretchable 5 ... 5.2 mm

	plain	793-5501	5
---	-------	----------	---

Accessories; 2203 Series

Appropriate marking systems:
WMB/WMB Inline/Marking strips

Operating tool; 3.5 mm and 2.5 mm blade; for TOPJOB® S
Installation Terminal Blocks



2009-309 50 (1)

Operating tool; 3.5 mm and 5.5 mm blade; for TOPJOB® S
Installation Terminal Blocks



2009-310 50 (1)

Operating tool; (3.5 x 0.5) mm blade; with a partially
insulated shaft



210-720 1

Multilevel Installation Terminal Block TOPJOB® S; with Push-Button; with N-Disconnect Slide Link

4 (6) mm²; 2205 Series

Technical Data	
0.5 ... 4 (6) mm ² ①	20 ... 10 AWG
250 V/4 kV/3; 31 A (35 A) ②	
400 V/6 kV/3; 31 A (35 A) ②	
Terminal block width: 6.2 mm / 0.244 inch	
11 ... 13 mm / 0.43 ... 0.51 inch	

Technical Data	
0.5 ... 4 (6) mm ² ①	20 ... 10 AWG
400 V/6 kV/3 ②	
I _N 32 A (40 A)	
Terminal block width: 6.2 mm / 0.244 inch	
11 ... 13 mm / 0.43 ... 0.51 inch	

Technical Data	
0.5 ... 4 (6) mm ² ①	20 ... 10 AWG
250 V/4 kV/3; 32 A (40 A) ②	
400 V/6 kV/3; 32 A (40 A) ②	
Terminal block width: 6.2 mm / 0.244 inch	
11 ... 13 mm / 0.43 ... 0.51 inch	

3

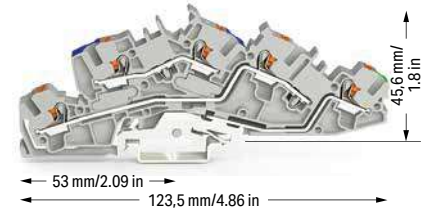
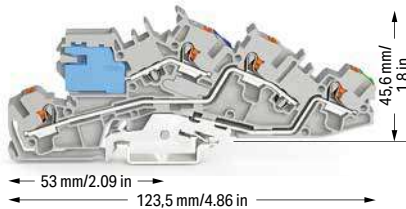

Multilevel installation terminal block; with push-button; with N-disconnect slide link; gray

	Item No.	Pack. Unit
○ NT/L/PE	2205-7641	50

Multilevel installation terminal block; with push-button; gray

	Item No.	Pack. Unit
○ L/L	2205-7642	50
○ N/L	2205-7649	50

Multilevel installation terminal block; with push-button; gray

	Item No.	Pack. Unit
○ N/L/PE	2205-7646	50
○ L/L/PE	2205-7645	50

Accessories; 2205 Series

Appropriate marking systems: WMB/Marking strips

End and intermediate plate; 1 mm thick

orange	2205-7692	100 (25)
--------	-----------	----------

Busbar carrier; not suitable as an end stop; snaps onto DIN-35 rail; 1.5 mm thick

blue	2009-304	100 (25)
------	----------	----------

Busbar carrier; with end stop function and detachable separator plate; snaps onto DIN-35 rail; 7.5 mm thick

blue	2009-305	25
------	----------	----

Busbar; tin-plated; 1000 mm long; copper (10 x 3) mm

I _N 140 A	210-133	1
----------------------	---------	---

Busbar cover; 1000 mm long

transparent	777-303	1
-------------	---------	---

1-conductor N-disconnect terminal block; I_N 76 A; 16 mm²; 12 mm wide

blue	2016-7714	20
------	-----------	----

1-conductor N-disconnect terminal block; I_N 125 A; 35 mm²; 16 mm wide

blue	785-613	15
------	---------	----

2-conductor supply terminal block for distribution boxes; I_N 76 A; 16 mm²; 12 mm wide

gray	2016-7601	20
blue	2016-7604	20

2-conductor through terminal block; I_N 125 A; 35 mm²; 16 mm wide

gray	785-601	15
blue	785-604	15

2-conductor ground terminal block; 16 mm²; 12 mm wide

green-yellow	2016-7607	20
--------------	-----------	----

2-conductor ground terminal block; 35 mm²; 16 mm wide

green-yellow	785-607	15
--------------	---------	----

Connector; for busbar; 2.5 ... 16 mm²

blue	210-281	100 (50)
------	---------	----------

Connector; for busbar; 2.5 ... 35 mm²

silver-colored	209-105	50
----------------	---------	----

Lock-out; prevents reclosing of slide link; snap-on type

orange	2005-7300	100 (25)
--------	-----------	----------

Insulation stop; 5 pcs/strip; 0.25 ... 0.5 mm²

light gray	2004-171	200 (25)
------------	----------	----------

Insulation stop; 5 pcs/strip; 0.75 ... 1 mm²

dark gray	2004-172	200 (25)
-----------	----------	----------

Push-in type jumper bar; insulated; I_N 32 A; light gray

2-way	2004-402	25
3-way	2004-403	25
4-way	2004-404	25
5-way	2004-405	25
6-way	2004-406	25
7-way	2004-407	25
8-way	2004-408	25
9-way	2004-409	25
10-way	2004-410	25

Push-in type jumper bar; insulated; I_N 32 A; light gray

1 to 3	2004-433	25
1 to 4	2004-434	25
1 to 5	2004-435	25
1 to 6	2004-436	25
1 to 7	2004-437	25
1 to 8	2004-438	25
1 to 9	2004-439	25
1 to 10	2004-440	25

Testing tap; for max. 2.5 mm²

gray	2009-182	100 (25)
------	----------	----------

Marking strip; plain; 11 mm wide; 50 m reel

white	2009-110	1
-------	----------	---

WMB marker card; white; 10 strips with 10 markers/card; stretchable 5 ... 5.2 mm

plain	793-5501	5
-------	----------	---

Operating tool; 3.5 mm and 2.5 mm blade; for TOPJOB® S Installation Terminal Blocks

	2009-309	50 (1)
--	----------	--------

Operating tool; 3.5 mm and 5.5 mm blade; for TOPJOB® S Installation Terminal Blocks

	2009-310	50 (1)
--	----------	--------

Operating tool; (3.5 x 0.5) mm blade; with a partially insulated shaft

	210-720	1
--	---------	---

① Conductor range: 0.5 ... 6 mm² "s+f-st"
 Push-in termination: 1.5 ... 6 mm² "s" and 1.5 ... 4 mm² "insulated ferrules, 12 mm"
 Depending on the conductor characteristic, a conductor with a smaller cross-section can also be inserted via push-in termination.

② 250 V / 400 V = rated voltage
 4 kV / 6 kV = rated impulse voltage
 3 = pollution degree
 (see Section 15)
 250 V/4 kV potential – ground
 400 V/6 kV potential – potential

Please observe the application notes:
 Testing accessories, page 181
 Marking, from page 684

Approvals and corresponding ratings,
 visit www.wago.com

Application note:

N-disconnect slide links, used in installation terminal blocks, consist of switch contacts that are opened and then closed again as part of regular circuit testing. To guarantee a reliable connection, a corrosion-resistant contact area is required on the N-busbar.

Historically, uninsulated copper busbars that have been cleaned/stripped of any possible corrosion before install can be used in dry, pollution-free locations.

According to DIN VDE 0100-520 (VDE 0100, Part 520), installation equipment exposed to contamination or corrosive substances (e.g., water) that promote corrosion or deterioration must be protected or made of a corrosion- or wear-resistant material. In these cases, tinned copper busbars guarantee a reliable connection.

WAGO only offers tinned copper busbars.

Multilevel Installation Terminal Block TOPJOB® S; with N-Disconnect Slide Link

2.5 (4) mm²; 2003 Series

Technical Data

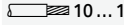
0.25 ... 2.5 (4) mm² ① | 22 ... 12 AWG
 250 V / 4 kV / 3; 24 A (32 A) ②
 400 V / 6 kV / 3; 24 A (32 A) ②
 Terminal block width: 5.2 mm / 0.205 inch
 10 ... 12 mm / 0.39 ... 0.47 inch

Technical Data

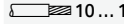
0.25 ... 2.5 (4) mm² ① | 22 ... 12 AWG
 400 V / 6 kV / 3 ②
 I_N 24 A (32 A)
 Terminal block width: 5.2 mm / 0.205 inch
 10 ... 12 mm / 0.39 ... 0.47 inch

① Conductor range: 0.25 ... 4 mm² "s+f-st";
 Push-in termination: 1 ... 4 mm² "s" and 1 ... 2.5 mm²
 "insulated ferrules, 12 mm"
 Depending on the conductor characteristic, a conductor with a smaller cross section can also be inserted via push-in termination.

② 250 V / 400 V = rated voltage
 4 kV / 6 kV = rated impulse voltage
 3 = pollution degree
 (see Section 15)
 250 V / 4 kV potential – ground
 400 V / 6 kV potential – potential

Please observe the application notes:
 Jumpers, from page 182
 Testing accessories, page 181
 Marking, from page 684

Approvals and corresponding ratings, visit www.wago.com

Accessories; 2003 Series

Appropriate marking systems:
 WMB/WMB Inline/Marking strips

2-conductor ground terminal block; 35 mm²; 16 mm wide

	green-yellow	785-607	15
---	--------------	---------	----

Connector; for busbar; 2.5 ... 16 mm²

	blue	210-281	100 (50)
--	------	---------	----------

Connector; for busbar; 2.5 ... 35 mm²

	unplated	209-105	50
---	----------	---------	----

Lock-out; prevents reclosing of slide link; snap-on type

	orange	2003-7300	100 (25)
---	--------	-----------	----------

Insulation stop; 5 pcs/strip; 0.25 ... 0.5 mm²

	light gray	2002-171	200 (25)
---	------------	----------	----------

Insulation stop; 5 pcs/strip; 0.75 ... 1 mm²

	dark gray	2002-172	200 (25)
---	-----------	----------	----------

Push-in type jumper bar; insulated; I_N 25 A; light gray

	2-way	2002-402	25
	3-way	2002-403	25
	4-way	2002-404	25
	5-way	2002-405	25
	6-way	2002-406	25
	7-way	2002-407	25
	8-way	2002-408	25
	9-way	2002-409	25
	10-way	2002-410	25

Push-in type jumper bar; insulated; I_N 25 A; light gray

	1 to 3	2002-433	25
	1 to 4	2002-434	25
	1 to 5	2002-435	25
	1 to 6	2002-436	25
	1 to 7	2002-437	25
	1 to 8	2002-438	25
	1 to 9	2002-439	25
	1 to 10	2002-440	25

3

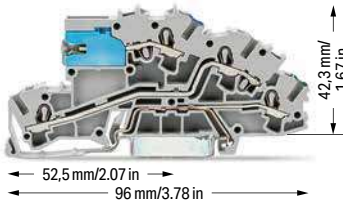

Multilevel installation terminal block; with N-disconnect slide link; gray

	Item No.	Pack. Unit
<input type="radio"/> NT/L/PE	2003-7641	50

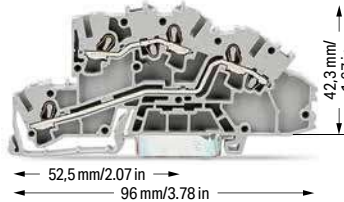

Multilevel installation terminal block; gray

	Item No.	Pack. Unit
<input type="radio"/> L/L	2003-7642	50
<input type="radio"/> N/L	2003-7649	50

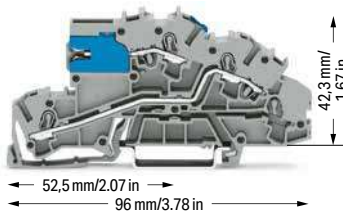

Multilevel installation terminal block; with N-disconnect slide link; gray

	Item No.	Pack. Unit
<input type="radio"/> NT/L	2003-7640	50
<input type="radio"/> LT/L	2003-7659	50

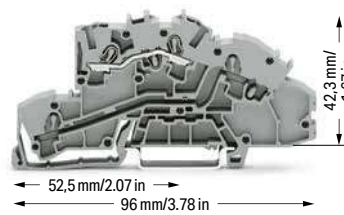

Multilevel installation terminal block; gray

	Item No.	Pack. Unit
<input type="radio"/> L	2003-7650	50
<input type="radio"/> N	2003-7651	50

Multilevel installation terminal block; gray

<input type="radio"/> N/L/PE	2003-7646	50
<input type="radio"/> L/L/PE	2003-7645	50

Accessories; 2003 Series

Appropriate marking systems: WMB/WMB Inline/Marking strips

End and intermediate plate; 0.8 mm thick

	orange	2003-7692	100 (25)
--	--------	-----------	----------

Busbar cover; 1000 mm long

	transparent	777-303	1
---	-------------	---------	---

Busbar carrier; not suitable as an end stop; snaps onto DIN-35 rail; 1.5 mm thick

	blue	2009-304	100 (25)
--	------	----------	----------

1-conductor N-disconnect terminal block; I_N 76 A; 16 mm²; 12 mm wide

	blue	2016-7714	20
---	------	-----------	----

Busbar carrier; with end stop function and detachable separator plate; snaps onto DIN-35 rail; 7.5 mm thick

	blue	2009-305	25
--	------	----------	----

1-conductor N-disconnect terminal block; I_N 125 A; 35 mm²; 16 mm wide

	blue	785-613	15
---	------	---------	----

Busbar; tin-plated; 1000 mm long; copper (10 x 3) mm

	I _N 140 A	210-133	1
--	----------------------	---------	---

2-conductor ground terminal block; 16 mm²; 12 mm wide

	green-yellow	2016-7607	20
---	--------------	-----------	----

Accessories; 2003 Series

Appropriate marking systems:
WMB/WMB Inline/Marking strips

Continuous jumper; insulated; I_N 25 A, light gray

2-way	2002-400	25
-------	----------	----

Continuous jumper; insulated; I_N 25 A; light gray

1 to 3	2002-423	25
1 to 4	2002-424	25

Continuous jumper; insulated; I_N 25 A, light gray

3-way	2002-413	25
5-way	2002-415	25

Staggered jumper; insulated; I_N 25 A; light gray

2-way	2002-472	25
3-way	2002-473	25
4-way	2002-474	25
5-way	2002-475	25
6-way	2002-476	25
7-way	2002-477	25
8-way	2002-478	25
9-way	2002-479	25
10-way	2002-480	25
11-way	2002-481	25
12-way	2002-482	25

Customized staggered jumper; insulated; with contact lugs broken off at the factory and circuit printing; I_N 25 A; light gray

1-3	2002-473/011-000	25
1-3-5	2002-475/011-000	25
1-3-5-7	2002-477/011-000	25
1-3-5-7-9	2002-479/011-000	25
1-3-5-7-9-11	2002-481/011-000	25

Push-in type wire jumper; insulated; 1.5 mm² conductor cross-section; I_N 18 A

L = 60 mm	2009-412	100 (10)
L = 110 mm	2009-414	100 (10)
L = 250 mm	2009-416	100 (10)



Test plug adapter; for 4 mm Ø test plug

gray	2009-174	100 (25)
------	----------	----------

Testing tap; for max. 2.5 mm²

gray	2009-182	100 (25)
------	----------	----------



Marking strip; plain; 11 mm wide; 50 m reel

white	2009-110	1
-------	----------	---



WMB Inline, plain; 1,500 WMB markers (5 mm)/reel; 5 ... 5.2 mm stretchable

white	2009-115	1
-------	----------	---



WMB marking card; white; 10 strips with 10 markers/card; 5 ... 5.2 mm stretchable

plain	793-5501	5
-------	----------	---



Operating tool; 3.5 mm and 2.5 mm blade width; for Installation Terminal Blocks TOPJOB® S

2009-309	50 (1)
----------	--------



Accessories; 2003 Series

Appropriate marking systems:
WMB/WMB Inline/Marking strips

Operating tool; 3.5 mm and 5.5 mm blade width; for Installation Terminal Blocks TOPJOB® S

2009-310	50 (1)
----------	--------



Operating tool; blade 3.5 x 0.5 mm; with a partially insulated shaft

210-720	1
---------	---

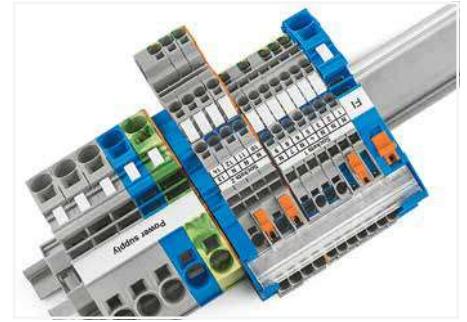

TOPJOB® S – Terminal Blocks for Every Application

- Push-in termination of solid conductors on distribution boards saves time and money.
- Operating errors can be prevented as all Terminal Blocks for building installations are equipped with push-in connection technology.
- Using standard accessories reduces order-processing and warehousing costs.
- The busbar position is the same, making Installation Terminal Blocks TOPJOB® S compatible with standard Installation Terminal Blocks TOPJOB®.

For the construction and operation of power installations in fire-prone, hazardous locations or public buildings – such as conference centers, stores, hospitals, schools, theaters or hotels – the DIN VDE 0100-710 or DIN VDE 0100-718 standards shall be observed. DIN VDE 0100-482 shall also be observed for fire-prone, hazardous locations. These VDE regulations mandate that every neutral conductor must be provided with a disconnection device so, e.g., insulation resistance measurement is possible for every circuit without disconnecting the N-conductor. WAGO's N-disconnect terminal blocks meet this requirement.

Application note:

N-disconnect slide links, used in installation terminal blocks, consist of switch contacts that are opened and then closed again as part of regular circuit testing. To guarantee a reliable connection, a corrosion-resistant contact area is required on the N-busbar.

Historically, uninsulated copper busbars that have been cleaned/stripped of any possible corrosion before install can be used in dry, pollution-free locations.

According to DIN VDE 0100-520 (VDE 0100, Part 520), installation equipment exposed to contamination or corrosive substances (e.g., water) that promote corrosion or deterioration must be protected or made of a corrosion- or wear-resistant material. In these cases, tinned copper busbars guarantee a reliable connection.

WAGO only offers tinned copper busbars.

Multilevel Installation Terminal Block TOPJOB® S; with Internal N-Disconnection

2.5 (4) mm²; 2003 Series

Technical Data	
0.25 ... 2.5 (4) mm ² ①	22 ... 12 AWG
250 V / 4 kV / 3; 20 A (25 A) ②	300 V, 20 A ③
400 V / 6 kV / 3; 20 A (25 A) ②	300 V, 20 A ④
Terminal block width: 5.2 mm / 0.205 inch	
 10 ... 12 mm / 0.39 ... 0.47 inch	

Technical Data	
0.25 ... 2.5 (4) mm ² ①	22 ... 12 AWG
400 V / 6 kV / 3 ②	300 V, 20 A ③
I _N 24 A (28 A)	300 V, 20 A ④
Terminal block width: 5.2 mm / 0.205 inch	
 10 ... 12 mm / 0.39 ... 0.47 inch	

Technical Data	
0.25 ... 2.5 (4) mm ² ①	22 ... 12 AWG
250 V / 4 kV / 3; 24 A (28 A) ②	300 V, 20 A ③
400 V / 6 kV / 3; 24 A (28 A) ②	300 V, 20 A ④
Terminal block width: 5.2 mm / 0.205 inch	
 10 ... 12 mm / 0.39 ... 0.47 inch	

3

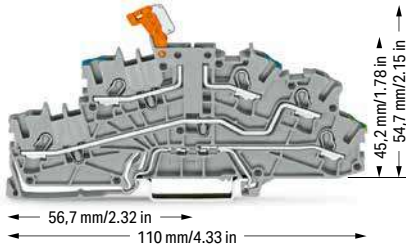

Multilevel installation terminal block; with pivoting knife disconnect; gray

	Item No.	Pack. Unit
<input type="radio"/> NT/L/PE	2003-6641	50
<input type="radio"/> LT/L/PE	2003-6644	50

Accessories; item-specific

N/L-test plug adapter; for vertical test slot; gray

	2-pole	2003-499	100 (25)
--	--------	----------	----------

N-test plug adapter; for vertical test slot; gray

	1-pole	2003-500	100 (25)
---	--------	----------	----------

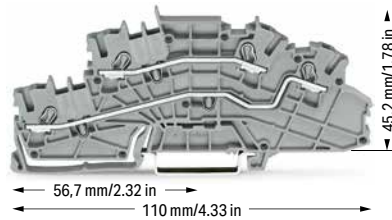

Multilevel installation terminal block; gray

	Item No.	Pack. Unit
<input type="radio"/> L/L	2003-6642	50
<input type="radio"/> N/L	2003-6649	50

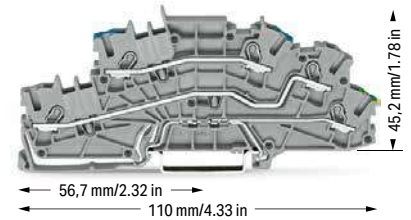

Multilevel installation terminal block; gray

	Item No.	Pack. Unit
<input type="radio"/> N/L/PE	2003-6646	50
<input type="radio"/> L/L/PE	2003-6645	50

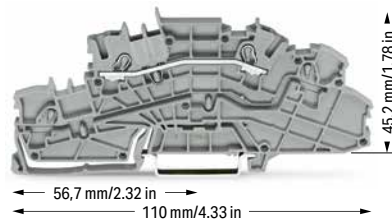

Multilevel installation terminal block; gray

	Item No.	Pack. Unit
<input type="radio"/> L	2003-6650	50
<input type="radio"/> N	2003-6651	50

Accessories; 2003 Series

Appropriate marking systems: WMB/WMB Inline/Marking strips

End and intermediate plate; 0.8 mm thick

	orange	2003-6692	100 (25)
--	--------	-----------	----------

Insulation stop; 5 pcs/strip; 0.25 ... 0.5 mm²

	light gray	2002-171	200 (25)
--	------------	----------	----------

Insulation stop; 5 pcs/strip; 0.75 ... 1 mm²

	dark gray	2002-172	200 (25)
--	-----------	----------	----------

Push-in type jumper bar; insulated; I_N 25 A; light gray

	2-way	2002-402	25
	3-way	2002-403	25
	4-way	2002-404	25
	5-way	2002-405	25
	6-way	2002-406	25
	7-way	2002-407	25
	8-way	2002-408	25
	9-way	2002-409	25
	10-way	2002-410	25

Push-in type jumper bar; insulated; I_N 25 A; light gray

	1 to 3	2002-433	25
	1 to 4	2002-434	25
	1 to 5	2002-435	25
	1 to 6	2002-436	25
	1 to 7	2002-437	25
	1 to 8	2002-438	25
	1 to 9	2002-439	25
	1 to 10	2002-440	25

Push-in type wire jumper; insulated; 1.5 mm² conductor cross-section; I_N 18 A

	L = 60 mm	2009-412	100 (10)
	L = 110 mm	2009-414	100 (10)
	L = 250 mm	2009-416	100 (10)

① Conductor range: 0.25 ... 4 mm² "s+f-st";
Push-in termination: 1 ... 4 mm² "s" and 1 ... 2.5 mm² "insulated ferrules, 12 mm"
Depending on the conductor characteristic, a conductor with a smaller cross section can also be inserted via push-in termination.

② 250 V / 400 V = rated voltage
4 kV / 6 kV = rated impulse voltage
3 = pollution degree
(see Section 15)
250 V / 4 kV potential – ground
400 V / 6 kV potential – potential

Please observe the application notes:
Jumpers, from page 182
Testing accessories, page 181
Marking, from page 684

Approvals and corresponding ratings, visit www.wago.com

Accessories; 2003 Series

Appropriate marking systems:
WMB/WMB Inline/Marking strips

Staggered jumper; insulated; I _N 25 A; light gray			
	2-way	2002-472	25
	3-way	2002-473	25
	4-way	2002-474	25
	5-way	2002-475	25
	6-way	2002-476	25
	7-way	2002-477	25
	8-way	2002-478	25
	9-way	2002-479	25
	10-way	2002-480	25
	11-way	2002-481	25
	12-way	2002-482	25

Customized staggered jumper; insulated; with contact lugs broken off at the factory and circuit printing; I_N 25 A; light gray

	1-3	2002-473/011-000	25
	1-3-5	2002-475/011-000	25
	1-3-5-7	2002-477/011-000	25
	1-3-5-7-9	2002-479/011-000	25
	1-3-5-7-9-11	2002-481/011-000	25

Continuous jumper; insulated; I_N 25 A, light gray

	2-way	2002-400	25
---	-------	----------	----

Continuous jumper; insulated; I_N 25 A; light gray

	1 to 3	2002-423	25
	1 to 4	2002-424	25

Continuous jumper; insulated; I_N 25 A, light gray

	3-way	2002-413	25
	5-way	2002-415	25

Test plug adapter; for 4 mm Ø test plug

	gray	2009-174	100 (25)
---	------	----------	----------

Testing tap; for max. 2.5 mm²

	gray	2009-182	100 (25)
---	------	----------	----------

Accessories; 2003 Series

Appropriate marking systems:
WMB/WMB Inline/Marking strips

Marking strip; plain; 11 mm wide; 50 m reel

	white	2009-110	1
---	-------	----------	---

WMB Inline, plain; 1,500 WMB markers (5 mm)/reel; 5 ... 5.2 mm stretchable

	white	2009-115	1
---	-------	----------	---

WMB marking card; white; 10 strips with 10 markers/card; 5 ... 5.2 mm stretchable

	plain	793-5501	5
---	-------	----------	---

Operating tool; 3.5 mm and 2.5 mm blade width; for Installation Terminal Blocks TOPJOB® S

		2009-309	50 (1)
---	--	----------	--------

Operating tool; 3.5 mm and 5.5 mm blade width; for Installation Terminal Blocks TOPJOB® S

		2009-310	50 (1)
---	--	----------	--------

Operating tool; blade 3.5 x 0.5 mm; with a partially insulated shaft

		210-720	1
---	--	---------	---

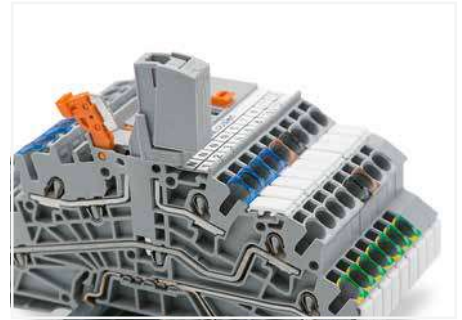

For multilevel installation terminal blocks with internal N-disconnection, test plug adapters can be inserted into the free vertical test slot when the N-potential is disconnected.

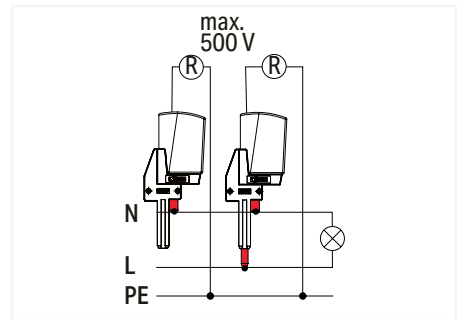

Test plug adapters for both individual N-potential measurement and insulation resistance measurement of the connected N- and L-potentials are available.

Multilevel Installation Terminal Block TOPJOB® S

2.5 (4) mm²; 2003 Series

Technical Data

0.25 ... 2.5 (4) mm² ① | 22 ... 12 AWG
 250 V / 4 kV / 3; 20 A (25 A) ② | 250 V, 6,3 A ③
 400 V / 6 kV / 3; 20 A (25 A) ② | 300 V, 20 A ④
 Terminal block width: 5.2 mm / 0.205 inch
 10 ... 12 mm / 0.39 ... 0.47 inch

Technical Data

0.25 ... 2.5 (4) mm² ① | 22 ... 12 AWG
 250 V / 4 kV / 3; 20 A (25 A) ② | 250 V, 6,3 A ③
 400 V / 6 kV / 3; 20 A (25 A) ② | 300 V, 20 A ④
 Terminal block width: 5.2 mm / 0.205 inch
 10 ... 12 mm / 0.39 ... 0.47 inch

3

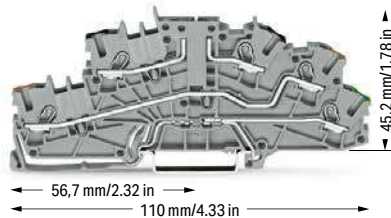
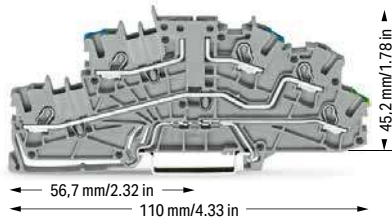

Multilevel installation terminal block; carrier terminal block without knife disconnect; gray

	Item No.	Pack. Unit
○ N/L/PE	2003-6640	50
○ L/L/PE	2003-6662	50

Multilevel installation terminal block; carrier terminal block without knife disconnect; blue middle-deck; green-yellow lower-deck printing; gray

○ L/N/PE	2003-6661	50
----------	-----------	----

Multilevel installation terminal block; carrier terminal block without knife disconnect; black upper-deck, brown middle-deck, green-yellow lower-deck printing

	Item No.	Pack. Unit
○ P2/P1/PE	2003-6643	50

Multilevel installation terminal block; carrier terminal block without knife disconnect; brown upper-deck, black middle-deck, green-yellow lower-deck printing

○ P1/P2/PE	2003-6660	50
------------	-----------	----

Accessories; 2003 Series

Appropriate marking systems: WMB/WMB Inline/Marking strips

N/L-test plug adapter; for vertical test slot; gray

	2-pole	2003-499	100 (25)
---	--------	----------	----------

N-test plug adapter; for vertical test slot; gray

	1-pole	2003-500	100 (25)
---	--------	----------	----------

End and intermediate plate; 0.8 mm thick

	orange	2003-6692	100 (25)
--	--------	-----------	----------

Fuse plug with pull-tab; for 5 x 20 mm glass cartridge fuse
 Electrical ratings are given by the fuse.

	gray	2004-911	50
---	------	----------	----

End and intermediate plate; only for use with fuse plugs; 1 mm thick

	orange	2003-6693	100 (25)
--	--------	-----------	----------

Double-fuse plug; for 5 x 20 mm glass cartridge fuse
 Electrical ratings are given by the fuse.

	gray	2003-911	25
--	------	----------	----

End and intermediate plate; 1 mm thick; only for use with double-fuse plugs

	orange	2003-6694	100 (25)
--	--------	-----------	----------

Push-in type jumper bar; insulated; I_n 25 A; light gray

	2-way	2002-402	25
	3-way	2002-403	25
	4-way	2002-404	25
	5-way	2002-405	25
	6-way	2002-406	25
	7-way	2002-407	25
	8-way	2002-408	25
	9-way	2002-409	25
	10-way	2002-410	25

Push-in type jumper bar; insulated; I_n 25 A; light gray

	1 to 3	2002-433	25
	1 to 4	2002-434	25
	1 to 5	2002-435	25
	1 to 6	2002-436	25
	1 to 7	2002-437	25
	1 to 8	2002-438	25
	1 to 9	2002-439	25
	1 to 10	2002-440	25

Push-in type wire jumper; insulated; 1.5 mm² conductor cross-section; I_n 18 A

	L = 60 mm	2009-412	100 (10)
	L = 110 mm	2009-414	100 (10)
	L = 250 mm	2009-416	100 (10)

① Conductor range: 0.25 ... 4 mm² "s+f-st";
 Push-in termination: 1 ... 4 mm² "s" and 1 ... 2.5 mm² "insulated ferrules, 12 mm"
 Depending on the conductor characteristic, a conductor with a smaller cross section can also be inserted via push-in termination.

② 250 V / 400 V = rated voltage
 4 kV / 6 kV = rated impulse voltage
 3 = pollution degree (see Section 15)
 250 V / 4 kV potential – ground
 400 V / 6 kV potential – potential
 Maximum current depends on accessories used.

Please observe the application notes:
 Jumpers, from page 182
 Testing accessories, page 181
 Marking, from page 684

Approvals and corresponding ratings, visit www.wago.com

Accessories; 2003 Series

Appropriate marking systems:
 WMB/WMB Inline/Marking strips

Staggered jumper; insulated; I_n 25 A; light gray

	2-way	2002-472	25
	3-way	2002-473	25
	4-way	2002-474	25
	5-way	2002-475	25
	6-way	2002-476	25
	7-way	2002-477	25
	8-way	2002-478	25
	9-way	2002-479	25
	10-way	2002-480	25
	11-way	2002-481	25
	12-way	2002-482	25

Customized staggered jumper; insulated; with contact lugs broken off at the factory and circuit printing; I_n 25 A; light gray

	1-3	2002-473/011-000	25
	1-3-5	2002-475/011-000	25
	1-3-5-7	2002-477/011-000	25
	1-3-5-7-9	2002-479/011-000	25
	1-3-5-7-9-11	2002-481/011-000	25

Continuous jumper; insulated; I_n 25 A, light gray

	2-way	2002-400	25
---	-------	----------	----

Continuous jumper; insulated; I_n 25 A; light gray

	1 to 3	2002-423	25
	1 to 4	2002-424	25

Continuous jumper; insulated; I_n 25 A, light gray

	3-way	2002-413	25
	5-way	2002-415	25

Test plug adapter; for 4 mm Ø test plug

	gray	2009-174	100 (25)
---	------	----------	----------

Testing tap; for max. 2.5 mm²

	gray	2009-182	100 (25)
---	------	----------	----------

Accessories; 2003 Series

Appropriate marking systems:
WMB/WMB Inline/Marking strips

Marking strip; plain; 11 mm wide; 50 m reel

white 2009-110 1

WMB Inline, plain; 1,500 WMB markers (5 mm)/reel; 5 ... 5.2 mm stretchable

white 2009-115 1

WMB marking card; white; 10 strips with 10 markers/card; 5 ... 5.2 mm stretchable

plain 793-5501 5

Operating tool; 3.5 mm and 2.5 mm blade width; for Installation Terminal Blocks TOPJOB® S

2009-309 50 (1)

Operating tool; 3.5 mm and 5.5 mm blade width; for Installation Terminal Blocks TOPJOB® S

2009-310 50 (1)

Operating tool; blade 3.5 x 0.5 mm; with a partially insulated shaft

210-720 1

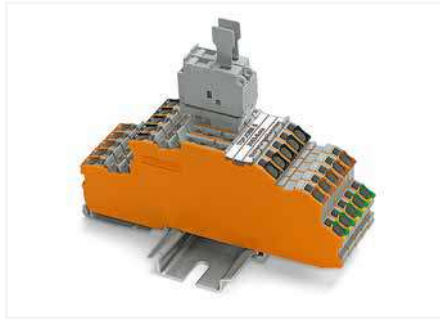

Single-fuse plugs can be used in combination with 1 mm thick end and intermediate plates on carrier terminal blocks without an N-knife disconnect.

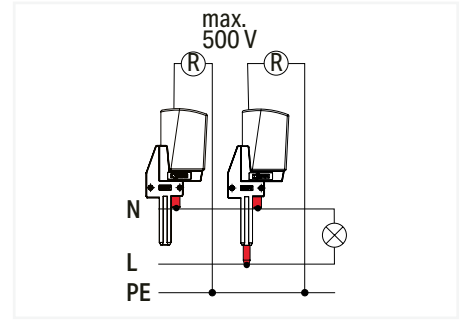

Test plug adapters for both individual N-potential measurement and insulation resistance measurement of the connected N- and L-potentials are available.

3

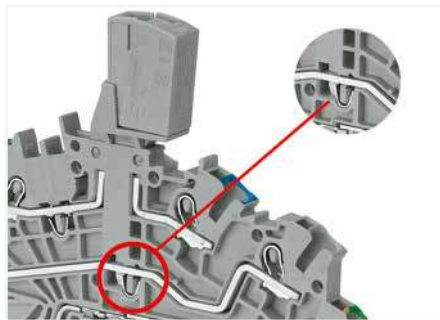

Multilevel installation terminal block fitted with an N/L-test plug adapter for quick and safe insulation resistance measurement of the connected N- and L-potentials

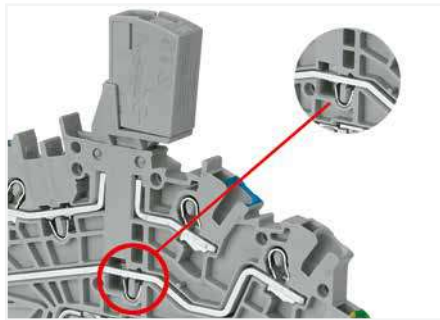

Multilevel installation terminal block fitted with an N-test plug adapter for insulation resistance measurement of the N-potential

Double-Fuse Plug TOPJOB® S on Carrier Terminal Block 2.5 (4) mm² 2003 Series

Technical Data

250 V / I_N 6.3 A
Plug width: 10.4 mm / 0.409 inch



Technical Data

250 V / I_N 6.3 A
Plug width: 10.4 mm / 0.409 inch

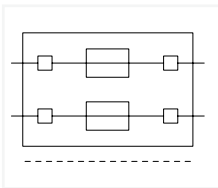

Double-fuse plug; for 5 x 20 mm glass cartridge fuse
Electrical ratings are given by the fuse.

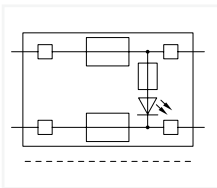

Double-fuse plug; for 5 x 20 mm glass cartridge fuse; with LED; gray
Electrical ratings are given by the fuse and blown fuse indication. Leakage current in case of a blown fuse: LED 0.25 mA

Color	Item No.	Pack. Unit
○ gray	2003-911	50

Color	Item No.	Pack. Unit
○ 230 V	2003-911/1000-923	50

Accessories; for fuse plugs

Appropriate marking systems: WMB/Marking strips

2-conductor carrier terminal block;
0.25 ... 2.5 (4) mm² / 22 ... 12 AWG
Terminal block width: 5.2 mm / 0.205 inch



gray	2002-1661	50
------	-----------	----

2-conductor carrier terminal block;
0.25 ... 2.5 (4) mm² / 22 ... 12 AWG
Terminal block width: 5.2 mm / 0.205 inch



gray	2002-1961	50
------	-----------	----

End and intermediate plate; 1 mm thick



orange	2002-1692	100 (25)
gray	2002-1691	100 (25)

End and intermediate plate; 1 mm thick



orange	2002-1992	100 (25)
gray	2002-1991	100 (25)

3-conductor carrier terminal block;
0.25 ... 2.5 (4) mm² / 22 ... 12 AWG
Terminal block width: 5.2 mm / 0.205 inch



gray	2002-1761	50
------	-----------	----

Double-deck carrier terminal block;
0.25 ... 2.5 (4) mm² / 22 ... 12 AWG
Terminal block width: 5.2 mm / 0.205 inch



L/L	2002-2961	50
-----	-----------	----

End and intermediate plate; 1 mm thick



orange	2002-1792	100 (25)
gray	2002-1791	100 (25)

Double-deck carrier terminal block;
0.25 ... 2.5 (4) mm² / 22 ... 12 AWG
Terminal block width: 5.2 mm / 0.205 inch



L/N	2002-2963	50
-----	-----------	----

4-conductor carrier terminal block;
0.25 ... 2.5 (4) mm² / 22 ... 12 AWG
Terminal block width: 5.2 mm / 0.205 inch



gray	2002-1861	50
------	-----------	----

Double-deck carrier terminal block;
0.25 ... 2.5 (4) mm² / 22 ... 12 AWG
Terminal block width: 5.2 mm / 0.205 inch



L/L	2002-2941	50
-----	-----------	----

End and intermediate plate; 1 mm thick



orange	2002-1892	100 (25)
gray	2002-1891	100 (25)

End and intermediate plate; 1 mm thick



orange	2002-2992	100 (25)
gray	2002-2991	100 (25)

End plate for fuse terminal blocks; 2 mm thick



orange	2002-992	100 (25)
gray	2002-991	100 (25)

Shorting link; 5 x 20 mm; allows the fuse plug to be used as a disconnect plug



I _N 6.3 A	281-503	250 (25)
----------------------	---------	----------

Length for 2002-1661 – 66.5 mm / 2.62 inch
2-conductor carrier terminal block

Length for 2002-1761 – 76.8 mm / 3.02 inch
3-conductor carrier terminal block

Length for 2002-1861 – 87.5 mm / 3.45 inch
4-conductor carrier terminal block

Length for 2002-1961 – 72.9 mm / 2.87 inch
2-conductor carrier terminal block with additional jumper slot

Length for 2002-2961 – 108 mm / 4.25 inch
Double-deck carrier terminal block

Length for 2003-6640 – 110 mm / 4.33 inch
Multilevel Installation Terminal Block

Approvals and corresponding ratings, visit www.wago.com

Accessories; for fuse plugs

Appropriate marking systems:
WMB/Marking strips

Multilevel installation terminal block;
0.25 ... 2.5 (4) mm² / 22 ... 12 AWG
Terminal block width: 5.2 mm / 0.205 inch



N/L/PE	2003-6640	50
--------	-----------	----

Multilevel installation terminal block;
0.25 ... 2.5 (4) mm² / 22 ... 12 AWG
Terminal block width: 5.2 mm / 0.205 inch



L/N/PE	2003-6661	50
--------	-----------	----

Multilevel installation terminal block;
0.25 ... 2.5 (4) mm² / 22 ... 12 AWG
Terminal block width: 5.2 mm / 0.205 inch



P2/P1/PE	2003-6643	50
----------	-----------	----

Multilevel installation terminal block;
0.25 ... 2.5 (4) mm² / 22 ... 12 AWG
Terminal block width: 5.2 mm / 0.205 inch



P1/P2/PE	2003-6660	50
----------	-----------	----

End and intermediate plate; 0.8 mm thick



orange	2003-6692	100 (25)
--------	-----------	----------

End and intermediate plate; 1 mm thick; only for use with double-fuse plugs



orange	2003-6694	100 (25)
--------	-----------	----------

WMB marking card; white; 10 strips with 10 markers/card; 5 ... 5.2 mm stretchable



plain	793-5501	5
-------	----------	---

WMB marking card; white; 10 strips with 10 markers/card; 5 ... 5.2 mm stretchable



F1, ..., F10 (10x)	794-5615	5
--------------------	----------	---

F11, ..., F20 (10x)	794-5616	5
---------------------	----------	---

F21, ..., F30 (10x)	794-5617	5
---------------------	----------	---

F31, ..., F40 (10x)	794-5618	5
---------------------	----------	---

F41, ..., F50 (10x)	794-5619	5
---------------------	----------	---



Double-fuse plugs with 5 x 25 mm glass cartridge fuses can be used on carrier terminal blocks without an N-knife disconnect in standard terminal block width.

Glass cartridge fuses 5 x 20

Series Item No.	Overload and short circuit protection		Short circuit protection only	
	Individual argmt.	Group argmt.	Individual argmt.	Group argmt.
Fuse terminal blocks				
2003-911	1.6 W	1.6 W	2.5 W	2.5 W
2003-911/.....				

When selecting glass cartridge fuses, make sure that the maximum power loss listed below is not exceeded. The power loss is determined according to IEC or EN 60947-7-3/VDE 0611-6 at 23°C. The temperature rise of the terminal blocks must be checked according to their application and mounting. Higher ambient temperatures represent an additional impact on fuse cartridges. Therefore, in such applications, the rated current must be reduced if necessary. More details are available from the manufacturers.

Multilevel Installation Terminal Block TOPJOB® S; with N-Disconnect Slide Link 4 (6) mm²; 2005 Series

Technical Data	
0.5 ... 4 (6) mm ² ①	20 ... 10 AWG
250 V / 4 kV / 3; 32 A (36 A) ②	
400 V / 6 kV / 3; 32 A (36 A) ②	
Terminal block width: 6.2 mm / 0.244 inch	
 11 ... 13 mm / 0.43 ... 0.51 inch	

Technical Data	
0.5 ... 4 (6) mm ² ①	20 ... 10 AWG
400 V / 6 kV / 3 ②	
I _N 32 A (36 A)	
Terminal block width: 6.2 mm / 0.244 inch	
 11 ... 13 mm / 0.43 ... 0.51 inch	

Technical Data	
0.5 ... 4 (6) mm ² ①	20 ... 10 AWG
250 V / 4 kV / 3; 32 A (36 A) ②	
400 V / 6 kV / 3; 32 A (36 A) ②	
Terminal block width: 6.2 mm / 0.244 inch	
 11 ... 13 mm / 0.43 ... 0.51 inch	

3

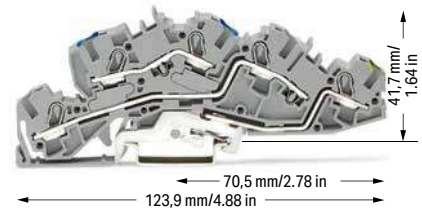
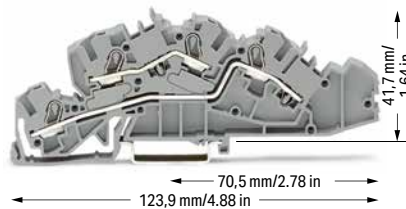

Multilevel installation terminal block; with N-disconnect slide link; gray

	Bestellnr.	VPE
○ NT/L/PE	2005-7641	50

Multilevel installation terminal block; gray

	Bestellnr.	VPE
○ L/L	2005-7642	50
○ N/L	2005-7649	50

Multilevel installation terminal block; gray

	Bestellnr.	VPE
○ N/L/PE	2005-7646	50
○ L/L/PE	2005-7645	50

Accessories; 2005 Series

Appropriate marking systems: WMB/Marking strips

End and intermediate plate; 1 mm thick

 orange	2005-7692	100 (25)
--	-----------	----------

Busbar carrier; not suitable as an end stop; snaps onto DIN-35 rail; 1.5 mm thick

 blue	2009-304	100 (25)
---	----------	----------

Busbar carrier; with end stop function and detachable separator plate; snaps onto DIN-35 rail; 7.5 mm thick

 blue	2009-305	25
---	----------	----

Busbar; tin-plated; 1000 mm long; copper (10 x 3) mm

 I _N 140 A	210-133	1
---	---------	---

Busbar cover; 1000 mm long

 transparent	777-303	1
--	---------	---

Lock-out; prevents reclosing of slide link; snap-on type

 orange	2005-7300	100 (25)
---	-----------	----------

1-conductor N-disconnect terminal block; I_N 76 A; 16 mm²; 12 mm wide

 blue	2016-7714	20
---	-----------	----

1-conductor N-disconnect terminal block; I_N 125 A; 35 mm²; 16 mm wide

 blue	785-613	15
---	---------	----

2-conductor ground terminal block; 16 mm²; 12 mm wide

 green-yellow	2016-7607	20
---	-----------	----

2-conductor ground terminal block; 35 mm²; 16 mm wide

 green-yellow	785-607	15
---	---------	----

Connector; for busbar; 2.5 ... 16 mm²

 blue	210-281	100 (50)
---	---------	----------

Connector; for busbar; 2.5 ... 35 mm²

 unplated	209-105	50
--	---------	----



Insulation stop; 5 pcs/strip; 0.25 ... 0.5 mm²

 light gray	2004-171	200 (25)
--	----------	----------



Insulation stop; 5 pcs/strip; 0.75 ... 1 mm²

 dark gray	2004-172	200 (25)
---	----------	----------

Push-in type jumper bar; insulated; I_N 32 A; light gray

 2-way	2004-402	25
 3-way	2004-403	25
 4-way	2004-404	25
 5-way	2004-405	25
 6-way	2004-406	25
 7-way	2004-407	25
 8-way	2004-408	25
 9-way	2004-409	25
 10-way	2004-410	25

Push-in type jumper bar; insulated; I_N 32 A; light gray

 1 to 3	2004-433	25
 1 to 4	2004-434	25
 1 to 5	2004-435	25
 1 to 6	2004-436	25
 1 to 7	2004-437	25
 1 to 8	2004-438	25
 1 to 9	2004-439	25
 1 to 10	2004-440	25

Test plug adapter; for 4 mm Ø test plug

 gray	2009-174	100 (25)
--	----------	----------

Testing tap; for max. 2.5 mm²

 gray	2009-182	100 (25)
--	----------	----------

Marking strip; plain; 11 mm wide; 50 m reel

 white	2009-110	1
--	----------	---

WMB marking card; white; 10 strips with 10 markers/card; 5 ... 5.2 mm stretchable

 plain	793-5501	5
---	----------	---

Operating tool; 3.5 mm and 2.5 mm blade width; for Installation Terminal Blocks TOPJOB® S

 2009-309	50 (1)
--	--------

Operating tool; 3.5 mm and 5.5 mm blade width; for Installation Terminal Blocks TOPJOB® S

 2009-310	50 (1)
--	--------

Operating tool; blade 3.5 x 0.5 mm; with a partially insulated shaft

 210-720	1
---	---

① Conductor range: 0.5 ... 6 mm² "s+f-st";
 Push-in termination: 1.5 ... 6 mm² "s" and 1.5 ... 4 mm²
 "insulated ferrules; 12 mm"
 Depending on the conductor characteristic, a conductor with a smaller cross section can also be inserted via push-in termination.

② 250 V / 400 V = rated voltage
 4 kV / 6 kV = rated impulse voltage
 3 = pollution degree
 (see Section 15)
 250 V / 4 kV potential – ground
 400 V / 6 kV potential – potential

Please observe the application notes:
 Testing accessories, page 181
 Marking, from page 684

Approvals and corresponding ratings,
 visit www.wago.com

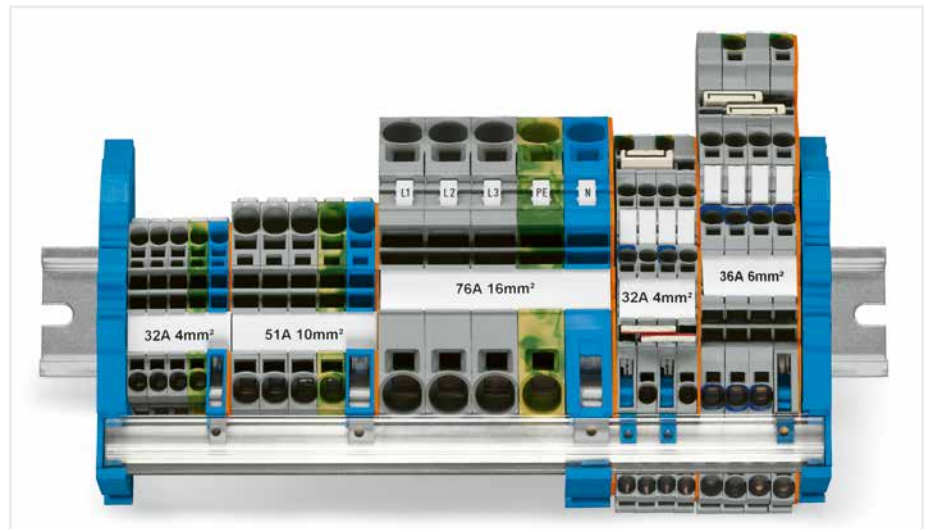

Application note:

N-disconnect slide links, used in installation terminal blocks, consist of switch contacts that are opened and then closed again as part of regular circuit testing. To guarantee a reliable connection, a corrosion-resistant contact area is required on the N-busbar.

Historically, uninsulated copper busbars that have been cleaned/stripped of any possible corrosion before install can be used in dry, pollution-free locations.

According to DIN VDE 0100-520 (VDE 0100, Part 520), installation equipment exposed to contamination or corrosive substances (e.g., water) that promote corrosion or deterioration must be protected or made of a corrosion- or wear-resistant material. In these cases, tinned copper busbars guarantee a reliable connection.

WAGO only offers tinned copper busbars.

PUSH-IN CAGE CLAMP®

N-Disconnect Terminal Block, Power Distribution Disconnect Terminal Block TOPJOB® S; with Push-Button

2206 Series; 2216 Series

Technical Data

0.5 ... 6 (10) mm ² ①	20 ... 8 AWG
250 V/4 kV/3 ③	
I _N 41 A (57 A)	
Terminal block width: 7.5 mm / 0.295 inch	
 13 ... 15 mm / 0.51 ... 0.59 inch	

Technical Data

0.5 ... 16 (25 "f-st") mm ² ②	20 ... 4 AWG
250 V/4 kV/3 ③	
I _N 69 A	
Terminal block width: 12 mm / 0.472 inch	
 18 ... 20 mm / 0.71 ... 0.79 inch	

① Conductor range: 0.5 ... 10 mm² "s+f-st"; Push-in termination: 2.5 ... 10 mm² "s" and 2.5 ... 6 mm² "insulated ferrules; 12 mm" Depending on the conductor characteristic, a conductor with a smaller cross section can also be inserted via push-in termination.

② Conductor range: 0.5 ... 16 mm² "s+f-st", 25 mm² "f-st"; Push-in termination: 6 ... 16 mm² "s" and 6 ... 16 mm² "insulated ferrules; 18 mm" Depending on the conductor characteristic, a conductor with a smaller cross section can also be inserted via push-in termination.

③ 250 V = rated voltage
4 kV = rated impulse voltage
3 = pollution degree (see Section 15)

Approvals and corresponding ratings, visit www.wago.com

3

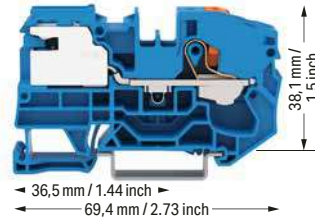
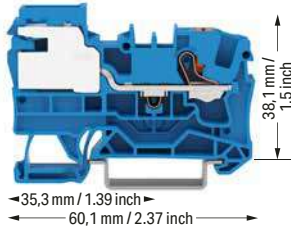

1-conductor N-disconnect terminal block; with push-button

Color	Item No.	Pack. Unit
 blue	2206-7114	50

1-conductor N-disconnect terminal block; with push-button

Color	Item No.	Pack. Unit
 blue	2216-7114	25

1-conductor power distribution disconnect terminal block; with push-button

 gray	2206-7111	50
---	-----------	----

1-conductor power distribution disconnect terminal block; with push-button

 gray	2216-7111	25
--	-----------	----

Appropriate through and ground conductor terminal blocks, see page 46

Appropriate through and ground conductor terminal blocks, see page 48

Accessories; item-specific

End and intermediate plate; 1 mm thick

 orange	2006-7192	100 (25)
---	-----------	----------

Accessories; item-specific

End and intermediate plate; 1 mm thick

 orange	2016-7192	100 (25)
--	-----------	----------

Lock-out; prevents reclosing of slide link; snap-on type

 orange	2006-7300	100 (25)
---	-----------	----------

Lock-out; prevents reclosing of slide link; snap-on type

 orange	2006-7300	100 (25)
--	-----------	----------

Accessories; for N-conductor and power distribution disconnect terminal blocks

Appropriate marking systems: WMB/Marking strips

Busbar carrier; not suitable as an end stop; snaps onto DIN-35 rail; 1.5 mm thick

 blue	2009-304	100 (25)
---	----------	----------

Marking strip; plain; 11 mm wide; 50 m reel

 white	2009-110	1
---	----------	---

Busbar carrier; with end stop function and detachable separator plate; snaps onto DIN-35 rail; 7.5 mm thick

 blue	2009-305	25
---	----------	----

WMB marker card; white; 10 strips with 10 markers/card; stretchable 5 ... 5.2 mm

 plain	793-5501	5
---	----------	---

Busbar; tin-plated; 1000 mm long; copper (10 x 3) mm

 I _N 140 A	210-133	1
---	---------	---

Busbar cover; 1000 mm long

 transparent	777-303	1
--	---------	---

Connector; for busbar; 2.5 ... 16 mm²

 blue	210-281	100 (50)
---	---------	----------

Connector; for busbar; 2.5 ... 35 mm²

 silver-colored	209-105	1
---	---------	---

N-Conductor Disconnect Terminal Blocks

For constructing and operating power installations in fire-prone, hazardous locations or public buildings – such as conference centers, stores, hospitals, schools, theaters or hotels – the DIN VDE 0100-710 or DIN VDE 0100-718 standards shall be observed. DIN VDE 0100-482 shall also be observed for fire-prone, hazardous locations. These VDE regulations mandate that every neutral conductor must be provided with a disconnection device so, e.g., insulation testing is possible for every circuit without disconnecting the N-conductor. WAGO's N-disconnect terminal blocks meet this requirement.

Power Distribution Disconnect Terminal Blocks

According to DIN VDE 0100-710, "Requirements for operating facilities, rooms and special installations – medical facilities," equipotential bonding conductors shall be run on a potential equalization busbar. The potential equalization busbar and the protective ground conductor busbar must be mounted in a common housing and be connected to each other using a disconnectable copper conductor of minimum 16 mm² (6 AWG). Furthermore, all equipotential bonding conductors must be connected to the potential equalization busbar and clearly arranged so they can be disconnected individually and accessed at any time. Depending on their function, they must be provided with captive marking. WAGO's power distribution disconnect terminal blocks meet these requirements.

N-Disconnect Terminal Block, Power Distribution Disconnect Terminal Block TOPJOB® S 2002 Series; 2006 Series; 2010 Series; 2016 Series

Technical Data	
0.25 ... 2.5 (4) mm ² ①	22 ... 12 AWG
250 V / 4 kV / 3 ⑤	
I _N 32 A	
Terminal block width: 5.2 mm / 0.205 inch	
10 ... 12 mm / 0.39 ... 0.47 inch	

Technical Data	
0.5 ... 6 (10) mm ² ②	20 ... 8 AWG
250 V / 4 kV / 3 ⑤	
I _N 51 A	
Terminal block width: 7.5 mm / 0.295 inch	
13 ... 15 mm / 0.51 ... 0.59 inch	

Technical Data	
0.5 ... 10 (16) mm ² ③	20 ... 6 AWG
250 V / 4 kV / 3 ⑤	
I _N 57 A	
Terminal block width: 10 mm / 0.394 inch	
17 ... 19 mm / 0.67 ... 0.75 inch	

3

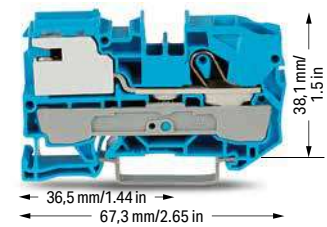
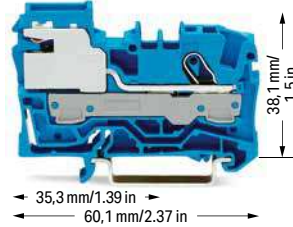
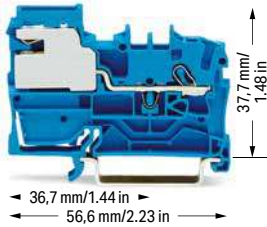

1-conductor N-disconnect terminal block		
Color	Item No.	Pack. Unit
● blue	2002-7114	50

1-conductor N-disconnect terminal block		
Color	Item No.	Pack. Unit
● blue	2006-7114	50

1-conductor N-disconnect terminal block		
Color	Item No.	Pack. Unit
● blue	2010-7114	25

1-conductor power distribution disconnect terminal block		
Color	Item No.	Pack. Unit
○ gray	2002-7111	50

1-conductor power distribution disconnect terminal block		
Color	Item No.	Pack. Unit
○ gray	2006-7111	50

1-conductor power distribution disconnect terminal block		
Color	Item No.	Pack. Unit
○ gray	2010-7111	25

Appropriate through and ground conductor terminal blocks, see page 56

Appropriate through and ground conductor terminal blocks, see page 62

Appropriate through and ground conductor terminal blocks, see page 63

Accessories; item-specific
End and intermediate plate; 0.8 mm thick

	orange	2002-7192	100 (25)
--	--------	-----------	----------

Accessories; item-specific
End and intermediate plate; 1 mm thick

	orange	2006-7192	100 (25)
--	--------	-----------	----------

Accessories; item-specific
End and intermediate plate; 1 mm thick

	orange	2010-7192	100 (25)
--	--------	-----------	----------

Lock-out; prevents reclosing of slide link; snap-on type

	orange	2005-7300	100 (25)
--	--------	-----------	----------

Lock-out; prevents reclosing of slide link; snap-on type

	orange	2006-7300	100 (25)
--	--------	-----------	----------

Lock-out; prevents reclosing of slide link; snap-on type

	orange	2006-7300	100 (25)
--	--------	-----------	----------

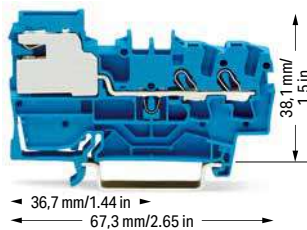

2-conductor N-disconnect terminal block		
Color	Item No.	Pack. Unit
● blue	2002-7214	50

2-conductor power distribution disconnect terminal block		
Color	Item No.	Pack. Unit
○ gray	2002-7211	50

Accessories; item-specific
End and intermediate plate; 0.8 mm thick

	orange	2002-7292	100 (25)
--	--------	-----------	----------

Lock-out; prevents reclosing of slide link; snap-on type

	orange	2005-7300	100 (25)
--	--------	-----------	----------

Accessories; for N-conductor and power distribution disconnect terminal blocks
Appropriate marking systems: WMB/Marking strips

Busbar carrier; not suitable as an end stop; snaps onto DIN-35 rail; 1.5 mm thick

	blue	2009-304	100 (25)
--	------	----------	----------

Marking strip; plain; 11 mm wide; 50 m reel

	white	2009-110	1
--	-------	----------	---

Busbar carrier; with end stop function and detachable separator plate; snaps onto DIN-35 rail; 7.5 mm thick

	blue	2009-305	25
--	------	----------	----

WMB marking card; white; 10 strips with 10 markers/card; 5 ... 5.2 mm stretchable

	plain	793-5501	5
--	-------	----------	---

Busbar; tin-plated; 1000 mm long; copper (10 x 3) mm

	I _N 140 A	210-133	1
--	----------------------	---------	---

Busbar cover; 1000 mm long

	transparent	777-303	1
--	-------------	---------	---

Connector; for busbar; 2.5 ... 16 mm²

	blue	210-281	100 (50)
--	------	---------	----------

Connector; for busbar; 2.5 ... 35 mm²

	unplated	209-105	1
--	----------	---------	---

Technical Data0.5 ... 16 (25 "f-st") mm² ③ | 20 ... 4 AWG

250 V / 4 kV / 3 ⑤

I_N 65 A

Terminal block width: 12 mm / 0.472 inch

18 ... 20 mm / 0.71 ... 0.79 inch

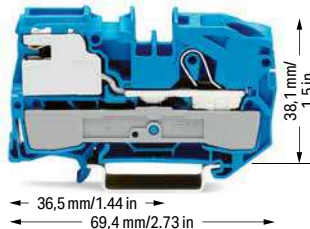
**1-conductor N-disconnect terminal block**

Color	Item No.	Pack. Unit
● blue	2016-7114	25

1-conductor power distribution disconnect terminal block

○ gray	2016-7111	25
--------	-----------	----

Appropriate through and ground conductor terminal blocks, see page 64

Accessories; item-specific**End and intermediate plate; 1 mm thick**

	orange	2016-7192	100 (25)
---	--------	-----------	----------

Lock-out; prevents reclosing of slide link; snap-on type

	orange	2006-7300	100 (25)
---	--------	-----------	----------

- Conductor range: 0.25 ... 4 mm² "s+f-st";
Push-in termination: 1 ... 4 mm² "s" and 1 ... 2.5 mm² "insulated ferrules; 12 mm"
Depending on the conductor characteristic, a conductor with a smaller cross section can also be inserted via push-in termination.
 - Conductor range: 0.5 ... 10 mm² "s+f-st";
Push-in termination: 2.5 ... 10 mm² "s" and 2.5 ... 6 mm² "insulated ferrules; 12 mm"
Depending on the conductor characteristic, a conductor with a smaller cross section can also be inserted via push-in termination.
 - Conductor range: 0.5 ... 16 mm² "s+f-st";
Push-in termination: 4 ... 16 mm² "s" and 4 ... 10 mm² "insulated ferrules; 18 mm"
Depending on the conductor characteristic, a conductor with a smaller cross section can also be inserted via push-in termination.
 - Conductor range: 0.5 ... 16 mm² "s+f-st", 25 mm² "f-st";
Push-in termination: 6 ... 16 mm² "s" and 6 ... 16 mm² "insulated ferrules; 18 mm"
Depending on the conductor characteristic, a conductor with a smaller cross section can also be inserted via push-in termination.
 - 250 V = rated voltage
4 kV = rated impulse voltage
3 = pollution degree
(see Section 15)
- Approvals and corresponding ratings, visit www.wago.com

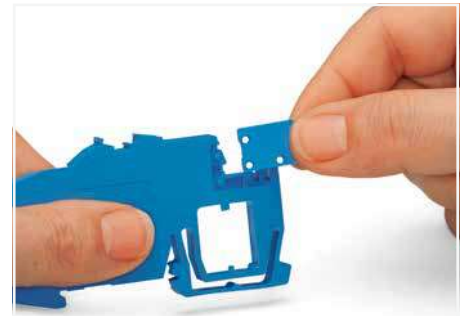

Inserting the separator plate into the busbar carrier to protect the N-busbar against accidental contact.

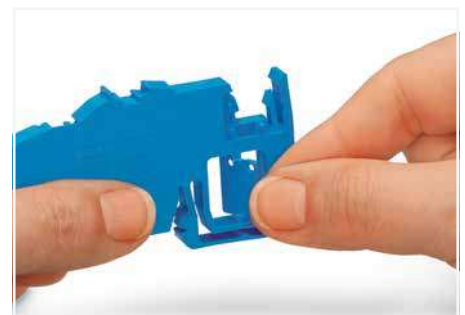

Removing the separator plate from the busbar carrier or from the N-disconnect terminal block.



Inserting separator plate removed from N-disconnect terminal block.



Touch-proof N-busbar via inserted separator plate

N-conductor disconnect terminal blocks:

For the construction and operation of power installations in fire-prone, hazardous locations or public buildings – such as conference centers, stores, hospitals, schools, theaters or hotels – the DIN VDE 0100-710 or DIN VDE 0100-718 standards shall be observed. DIN VDE 0100-482 shall also be observed for fire-prone, hazardous locations. These VDE regulations mandate that every neutral conductor must be provided with a disconnection device so, e.g., insulation testing is possible for every circuit without disconnecting the N-conductor. WAGO's N-disconnect terminal blocks meet this requirement.

Power distribution disconnect terminal blocks:

According to DIN VDE 0100-710, "Requirements for operating facilities, rooms and special installations – medical facilities," equipotential bonding conductors shall be run on a potential equalization busbar. The potential equalization busbar and the protective ground conductor busbar must be mounted in a common housing and be connected to each other using a disconnectable copper conductor of minimum 16 mm² (6 AWG). Furthermore, all equipotential bonding conductors must be connected to the potential equalization busbar and clearly arranged so they can be disconnected individually and accessed at any time. Depending on their function, they must be provided with captive marking. WAGO's power distribution disconnect terminal blocks meet these requirements.

PUSH-IN CAGE CLAMP®

Supply Terminal Block for Distribution Boxes, Ground Conductor Terminal Block, N-Disconnect Terminal Block, Power Distribution Disconnect Terminal Block TOPJOB® S

16 (25 "f-st") mm²; 2016 Series

Technical Data

0.5 ... 16 (25 "f-st") mm² ① | 20 ... 4 AWG
 800 V / 8 kV / 3 ②
 I_N 76 A
 Terminal block width: 12 mm / 0.472 inch
 18 ... 20 mm / 0.71 ... 0.79 inch

Technical Data



0.5 ... 16 (25 "f-st") mm² ① | 20 ... 4 AWG
 250 V / 4 kV / 3 ③
 I_N 76 A
 Terminal block width: 12 mm / 0.472 inch
 18 ... 20 mm / 0.71 ... 0.79 inch

- ① Conductor range: 0.5 ... 16 mm² "s+f-st", 25 mm² "f-st"; Push-in termination: 6 ... 16 mm² "s" and 6 ... 16 mm² "insulated ferrules; 18 mm"
 Depending on the conductor characteristic, a conductor with a smaller cross section can also be inserted via push-in termination.
 - ② 800 V = rated voltage
 8 kV = rated impulse voltage
 3 = pollution degree
 (see Section 15)
 - ③ 250 V = rated voltage
 4 kV = rated impulse voltage
 3 = pollution degree
 (see Section 15)
- Approvals and corresponding ratings, visit www.wago.com

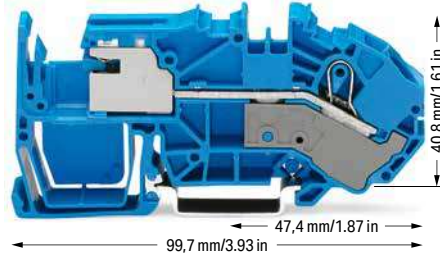
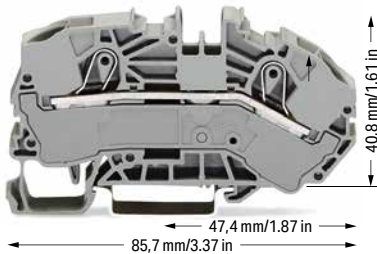
3



2-conductor supply terminal block for distribution boxes

Color	Item No.	Pack. Unit
 gray	2016-7601	20
 blue	2016-7604	20

1-conductor N-disconnect terminal block

Color	Item No.	Pack. Unit
 blue	2016-7714	20

2-conductor ground terminal block
 15 mm high DIN-35 rails shall be used for a current load higher than 76 A!



 green-yellow	2016-7607	20
---	-----------	----

1-conductor power distribution disconnect terminal block

 gray	2016-7711	20
--	-----------	----

Accessories; item-specific

End and intermediate plate; 1 mm thick

 orange	2016-7692	100 (25)
 gray	2016-7691	100 (25)

Accessories; item-specific

End and intermediate plate; 1 mm thick

 orange	2016-7792	100 (25)
--	-----------	----------

Protective warning marker; with black high-voltage symbol; for 5 terminal blocks

 yellow	2016-115	100 (25)
---	----------	----------

Lock-out; prevents reclosing of slide link; snap-on type

 orange	2006-7300	100 (25)
--	-----------	----------

Finger guard; touch-proof cover protects unused conductor entries

 yellow	2016-100	100 (25)
---	----------	----------

Busbar; tin-plated; 1000 mm long; copper (10 x 3) mm

	I _N 140 A	210-133	1
---	----------------------	---------	---

Busbar cover; 1000 mm long

	transparent	777-303	1
---	-------------	---------	---

Accessories; 2016 Series

Appropriate marking systems: WMB/Marking strips

Push-in type jumper bar; insulated; I_N 76 A; light gray

 2-way	2016-402	25
 3-way	2016-403	25
 4-way	2016-404	25
 5-way	2016-405	25

Marking strip; plain; 11 mm wide; 50 m reel

 white	2009-110	1
---	----------	---

Push-in type jumper bar; insulated; I_N 76 A; light gray

 1 to 3	2016-433	25
 1 to 4	2016-434	25
 1 to 5	2016-435	25

WMB marking card; white; 10 strips with 10 markers/card; 5 ... 5.2 mm stretchable

 plain	793-5501	5
---	----------	---

Test plug adapter; for 4 mm Ø test plug

 gray	2009-174	100 (25)
---	----------	----------

Testing tap; for max. 2.5 mm²

 gray	2009-182	100 (25)
---	----------	----------

N-conductor disconnect terminal blocks:

For the construction and operation of power installations in fire-prone, hazardous locations or public buildings – such as conference centers, stores, hospitals, schools, theaters or hotels – the DIN VDE 0100-710 or DIN VDE 0100-718 standards shall be observed. DIN VDE 0100-482 shall also be observed for fire-prone, hazardous locations. These VDE regulations mandate that every neutral conductor must be provided with a disconnection device so, e.g., insulation testing is possible for every circuit without disconnecting the N-conductor. WAGO's N-disconnect terminal blocks meet this requirement.

Power distribution disconnect terminal blocks:

According to DIN VDE 0100-710, "Requirements for operating facilities, rooms and special installations – medical facilities," equipotential bonding conductors shall be run on a potential equalization busbar. The potential equalization busbar and the protective ground conductor busbar must be mounted in a common housing and be connected to each other using a disconnectable copper conductor of minimum 16 mm² (6 AWG). Furthermore, all equipotential bonding conductors must be connected to the potential equalization busbar and clearly arranged so they can be disconnected individually and accessed at any time. Depending on their function, they must be provided with captive marking. WAGO's power distribution disconnect terminal blocks meet these requirements.

Supply Terminal Blocks Assembly TOPJOB® S

3

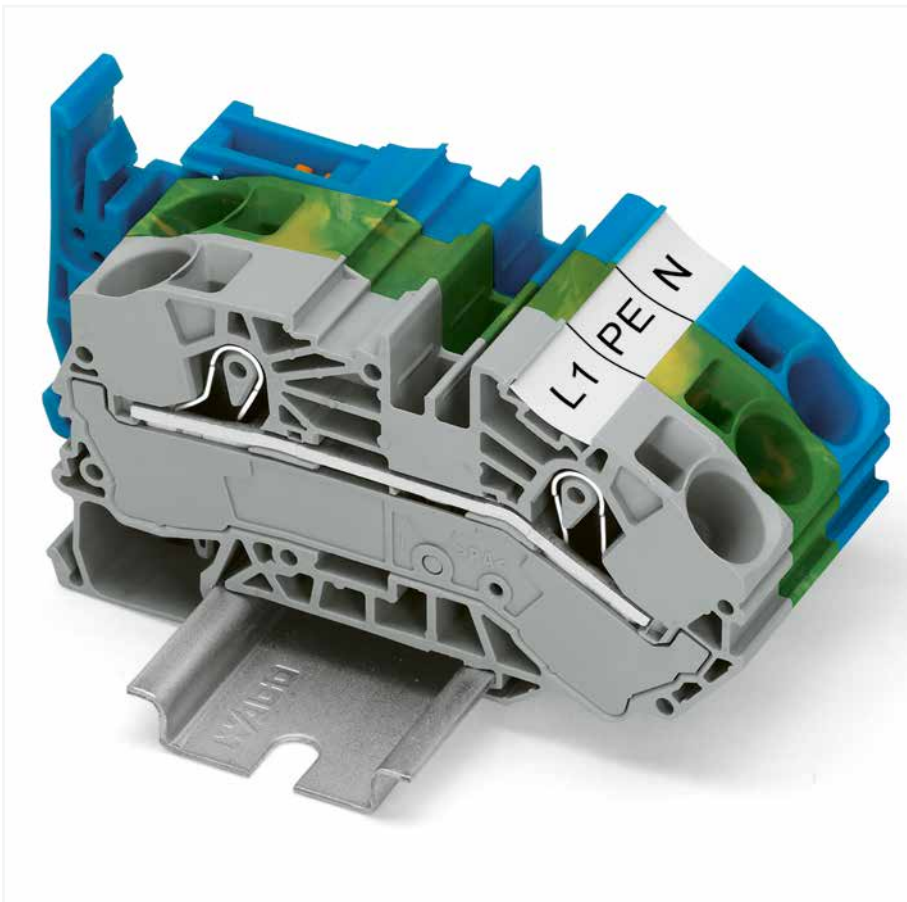

With an angled conductor entry, the 2016 Series Supply Terminal Blocks simplify the wiring of solid conductors in distribution boxes. Solid conductors of the largest cross-section can be connected easily, enabling the distribution box cover to fit without interfering with the conductors.

Board Set 821 Series

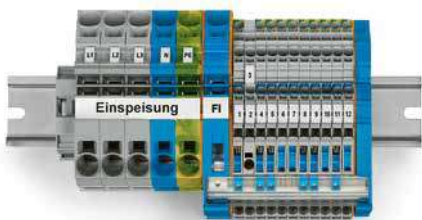

Subdistribution board set TOPJOB® S; with operating slots

	Item No.	Pack. Unit
	821-104	1

Contains:

- 10 x Multilevel installation terminal block; NT/L/PE; 4 mm² (2003-7641)
- 1 x Multilevel installation terminal block; L/L; 4 mm² (2003-7642)
- 1 x End and intermediate plate (2003-7692)
- 3 x 2-conductor supply terminal block for distribution boxes; gray; 16 mm² (2016-7601)
- 1 x 2-conductor supply terminal block for distribution boxes; blue; 16 mm² (2016-7604)
- 1 x 2-conductor ground terminal block; green-yellow; 16 mm² (2016-7607)
- 1 x End and intermediate plate (2016-7692)
- 1 x 1-conductor N-disconnect terminal block; blue; 16 mm² (2016-7714)
- 1 x End and intermediate plate (2016-7792)
- 1 x Screwless end stop; 10 mm wide (249-117)
- 1 x Busbar carrier; with end stop function (2009-305)
- 1 x Busbar; tin-plated; 0.2 m (210-133)
- 1 x N-busbar cover; transparent; 0.2 m (777-303)
- 1 x Marking strips; white; 0.5 m (2009-110)
- 1 x WMB marking card; 1 ... 50 (793-5566)
- 1 x WMB marking card; L1, L2, L3, N, PE (793-5472)
- 1 x Fiber-tip pen (210-110)

Subdistribution board set TOPJOB® S; with operating slots and push-button

	Item No.	Pack. Unit
	821-106	1

Contains:

- 10 x Multilevel installation terminal block; NT/L/PE; 4 mm² (2203-7541)
- 1 x Multilevel installation terminal block; L/L; 4 mm² (2203-7542)
- 1 x End and intermediate plate (2203-7692)
- 3 x 2-conductor supply terminal block for distribution boxes; gray; 16 mm² (2016-7601)
- 1 x 2-conductor supply terminal block for distribution boxes; blue; 16 mm² (2016-7604)
- 1 x 2-conductor ground terminal block; green-yellow; 16 mm² (2016-7607)
- 1 x End and intermediate plate (2016-7692)
- 1 x 1-conductor N-disconnect terminal block; blue; 16 mm² (2016-7714)
- 1 x End and intermediate plate (2016-7792)
- 1 x Screwless end stop; 10 mm wide (249-117)
- 1 x Busbar carrier; with end stop function (2009-305)
- 1 x Busbar; tin-plated; 0.2 m (210-133)
- 1 x N-busbar cover; transparent; 0.2 m (777-303)
- 1 x Marking strips; white; 0.5 m (2009-110)
- 1 x WMB marking card; 1 ... 50 (793-5566)
- 1 x WMB marking card; L1, L2, L3, N, PE (793-5472)
- 1 x Fiber-tip pen (210-110)

Subdistribution board set TOPJOB® S; with push-button

	Item No.	Pack. Unit
	821-107	1

Contains:

- 10 x Multilevel installation terminal block; NT/L/PE; 4 mm² (2203-7641)
- 1 x Multilevel installation terminal block; L/L; 4 mm² (2203-7642)
- 1 x End and intermediate plate (2203-7692)
- 3 x 2-conductor supply terminal block for distribution boxes; gray; 16 mm² (2016-7601)
- 1 x 2-conductor supply terminal block for distribution boxes; blue; 16 mm² (2016-7604)
- 1 x 2-conductor ground terminal block; green-yellow; 16 mm² (2016-7607)
- 1 x End and intermediate plate (2016-7692)
- 1 x 1-conductor N-disconnect terminal block; blue; 16 mm² (2016-7714)
- 1 x End and intermediate plate (2016-7792)
- 1 x Screwless end stop; 10 mm wide (249-117)
- 1 x Busbar carrier; with end stop function (2009-305)
- 1 x Busbar; tin-plated; 0.2 m (210-133)
- 1 x N-busbar cover; transparent; 0.2 m (777-303)
- 1 x Marking strips; white; 0.5 m (2009-110)
- 1 x WMB marking card; 1 ... 50 (793-5566)
- 1 x WMB marking card; L1, L2, L3, N, PE (793-5472)
- 1 x Fiber-tip pen (210-110)

Board Set 821 Series

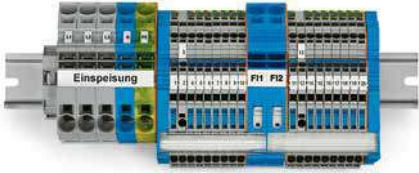

FI main distribution board set TOPJOB® S; with operating slots

	Item No.	Pack. Unit
	821-122	1

Contains:

- 16 x Multilevel installation terminal block; NT/L/PE; 4 mm² (2003-7641)
- 2 x Multilevel installation terminal block; L/L; 4 mm² (2003-7642)
- 2 x End and intermediate plate (2003-7692)
- 3 x 2-conductor supply terminal block for distribution boxes; gray; 16 mm² (2016-7601)
- 1 x 2-conductor supply terminal block for distribution boxes; blue; 16 mm² (2016-7604)
- 1 x 2-conductor ground terminal block; green-yellow; 16 mm² (2016-7607)
- 1 x End and intermediate plate (2016-7692)
- 2 x 1-conductor N-disconnect terminal block; blue; 16 mm² (2016-7714)
- 1 x End and intermediate plate (2016-7792)
- 1 x Screwless end stop; 10 mm wide (249-117)
- 2 x Busbar carrier; with end stop function (2009-305)
- 1 x Busbar; tin-plated; 0.2 m (210-133)
- 1 x N-busbar cover; transparent; 0.2 m (777-303)
- 1 x Marking strips; white; 0.5 m (2009-110)
- 1 x WMB marking card; 1 ... 50 (793-5566)
- 1 x WMB marking card; L1, L2, L3, N, PE (793-5472)
- 1 x Fiber-tip pen (210-110)

FI main distribution board set TOPJOB® S; with operating slots and push-button

	Item No.	Pack. Unit
	821-108	1

Contains:

- 16 x Multilevel installation terminal block; NT/L/PE; 4 mm² (2203-7541)
- 2 x Multilevel installation terminal block; L/L; 4 mm² (2203-7542)
- 2 x End and intermediate plate (2203-7692)
- 3 x 2-conductor supply terminal block for distribution boxes; gray; 16 mm² (2016-7601)
- 1 x 2-conductor supply terminal block for distribution boxes; blue; 16 mm² (2016-7604)
- 1 x 2-conductor ground terminal block; green-yellow; 16 mm² (2016-7607)
- 1 x End and intermediate plate (2016-7692)
- 2 x 1-conductor N-disconnect terminal block; blue; 16 mm² (2016-7714)
- 1 x End and intermediate plate (2016-7792)
- 1 x Screwless end stop; 10 mm wide (249-117)
- 2 x Busbar carrier; with end stop function (2009-305)
- 1 x Busbar; tin-plated; 0.2 m (210-133)
- 1 x N-busbar cover; transparent; 0.2 m (777-303)
- 1 x Marking strips; white; 0.5 m (2009-110)
- 1 x WMB marking card; 1 ... 50 (793-5566)
- 1 x WMB marking card; L1, L2, L3, N, PE (793-5472)
- 1 x Fiber-tip pen (210-110)

FI main distribution board set TOPJOB® S; with push-button

	Item No.	Pack. Unit
	821-109	1

Contains:

- 16 x Multilevel installation terminal block; NT/L/PE; 4 mm² (2203-7641)
- 2 x Multilevel installation terminal block; L/L; 4 mm² (2203-7642)
- 2 x End and intermediate plate (2203-7692)
- 3 x 2-conductor supply terminal block for distribution boxes; gray; 16 mm² (2016-7601)
- 1 x 2-conductor supply terminal block for distribution boxes; blue; 16 mm² (2016-7604)
- 1 x 2-conductor ground terminal block; green-yellow; 16 mm² (2016-7607)
- 1 x End and intermediate plate (2016-7692)
- 2 x 1-conductor N-disconnect terminal block; blue; 16 mm² (2016-7714)
- 1 x End and intermediate plate (2016-7792)
- 1 x Screwless end stop; 10 mm wide (249-117)
- 2 x Busbar carrier; with end stop function (2009-305)
- 1 x Busbar; tin-plated; 0.2 m (210-133)
- 1 x N-busbar cover; transparent; 0.2 m (777-303)
- 1 x Marking strips; white; 0.5 m (2009-110)
- 1 x WMB marking card; 1 ... 50 (793-5566)
- 1 x WMB marking card; L1, L2, L3, N, PE (793-5472)
- 1 x Fiber-tip pen (210-110)

Board Set 821 Series

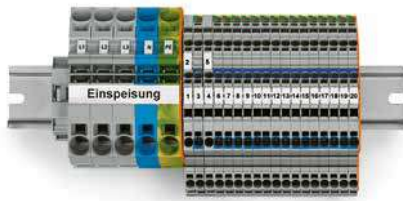

3

FI/LS main distribution board set TOPJOB® S; with operating slots

	Item No.	Pack. Unit
	821-123	1

Contains:

- 16 x Multilevel installation terminal block; NT/L/PE; 4 mm² (2003-7641)
- 2 x Multilevel installation terminal block; L/L; 4 mm² (2003-7642)
- 1 x End and intermediate plate (2003-7692)
- 3 x 2-conductor supply terminal block for distribution boxes; gray; 16 mm² (2016-7601)
- 1 x 2-conductor supply terminal block for distribution boxes; blue; 16 mm² (2016-7604)
- 1 x 2-conductor ground terminal block; green-yellow; 16 mm² (2016-7607)
- 1 x End and intermediate plate (2016-7692)
- 2 x Screwless end stop; 10 mm wide (249-117)
- 1 x Marking strips; white; 0.5 m (2009-110)
- 1 x WMB marking card; 1 ... 50 (793-5566)
- 1 x WMB marking card; L1, L2, L3, N, PE (793-5472)
- 1 x Fiber-tip pen (210-110)

FI/LS main distribution board set TOPJOB® S; with operating slots and push-button

	Item No.	Pack. Unit
	821-110	1

Contains:

- 16 x Multilevel installation terminal block; NT/L/PE; 4 mm² (2203-7541)
- 2 x Multilevel installation terminal block; L/L; 4 mm² (2203-7542)
- 1 x End and intermediate plate (2203-7692)
- 3 x 2-conductor supply terminal block for distribution boxes; gray; 16 mm² (2016-7601)
- 1 x 2-conductor supply terminal block for distribution boxes; blue; 16 mm² (2016-7604)
- 1 x 2-conductor ground terminal block; green-yellow; 16 mm² (2016-7607)
- 1 x End and intermediate plate (2016-7692)
- 2 x Screwless end stop; 10 mm wide (249-117)
- 1 x Marking strips; white; 0.5 m (2009-110)
- 1 x WMB marking card; 1 ... 50 (793-5566)
- 1 x WMB marking card; L1, L2, L3, N, PE (793-5472)
- 1 x Fiber-tip pen (210-110)

FI/LS main distribution board set TOPJOB® S; with push-button

	Item No.	Pack. Unit
	821-111	1

Contains:

- 16 x Multilevel installation terminal block; NT/L/PE; 4 mm² (2203-7641)
- 2 x Multilevel installation terminal block; L/L; 4 mm² (2203-7642)
- 1 x End and intermediate plate (2203-7692)
- 3 x 2-conductor supply terminal block for distribution boxes; gray; 16 mm² (2016-7601)
- 1 x 2-conductor supply terminal block for distribution boxes; blue; 16 mm² (2016-7604)
- 1 x 2-conductor ground terminal block; green-yellow; 16 mm² (2016-7607)
- 1 x End and intermediate plate (2016-7692)
- 2 x Screwless end stop; 10 mm wide (249-117)
- 1 x Marking strips; white; 0.5 m (2009-110)
- 1 x WMB marking card; 1 ... 50 (793-5566)
- 1 x WMB marking card; L1, L2, L3, N, PE (793-5472)
- 1 x Fiber-tip pen (210-110)

Board Set 821 Series

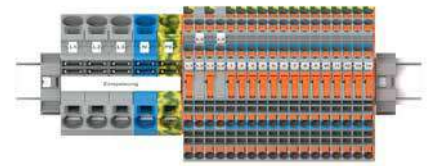
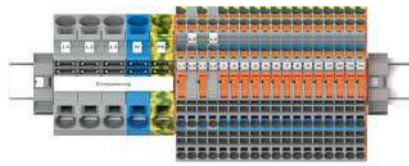
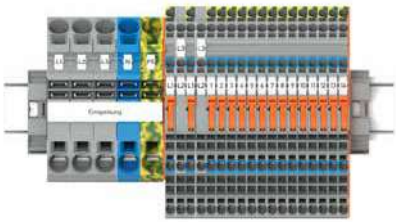

Set; with operating slots

Item No.	Pack. Unit
821-129	1

Contains:

- 16 x Multilevel installation terminal block; NT/L/PE; 4 mm² (2003-6641)
- 2 x Multilevel installation terminal block; L/L; 4 mm² (2003-6642)
- 1 x End and intermediate plate (2003-6692)
- 3 x 2-conductor supply terminal block for distribution boxes; gray; 16 mm² (2016-7601)
- 1 x 2-conductor supply terminal block for distribution boxes; blue; 16 mm² (2016-7604)
- 1 x 2-conductor ground terminal block; green-yellow; 16 mm² (2016-7607)
- 1 x End and intermediate plate (2016-7692)
- 2 x Screwless end stop; 10 mm wide (249-117)
- 15 x Push-in type jumper bar; 2-way (2002-402)
- 2 x Test plug adapter N/L; gray (2003-499)
- 2 x Test plug adapter N; gray (2003-500)
- 2 x Test plug adapter; for 4 mm Ø test plugs (2009-174)
- 1 x Marking strips; white; 0.5 m (2009-110)
- 1 x WMB marking card; 1 ... 50 (793-5566)
- 1 x WMB marking card; L1, L2, L3, N, PE (793-5472)
- 1 x Fiber-tip pen (210-110)

Set; with operating slots and push-button

Item No.	Pack. Unit
821-112	1

Contains:

- 16 x Multilevel installation terminal block; NT/L/PE; 4 mm² (2203-6541)
- 2 x Multilevel installation terminal block; L/L; 4 mm² (2203-6542)
- 1 x End and intermediate plate (2203-6692)
- 3 x 2-conductor supply terminal block for distribution boxes; gray; 16 mm² (2016-7601)
- 1 x 2-conductor supply terminal block for distribution boxes; blue; 16 mm² (2016-7604)
- 1 x 2-conductor ground terminal block; green-yellow; 16 mm² (2016-7607)
- 1 x End and intermediate plate (2016-7692)
- 2 x Screwless end stop; 10 mm wide (249-117)
- 15 x Push-in type jumper bar; 2-way (2002-402)
- 2 x Test plug adapter N/L; gray (2003-499)
- 2 x Test plug adapter N; gray (2003-500)
- 2 x Test plug adapter; for 4 mm Ø test plugs (2009-174)
- 1 x Marking strips; white; 0.5 m (2009-110)
- 1 x WMB marking card; 1 ... 50 (793-5566)
- 1 x WMB marking card; L1, L2, L3, N, PE (793-5472)
- 1 x Fiber-tip pen (210-110)

Set; with push-button

Item No.	Pack. Unit
821-113	1

Contains:

- 16 x Multilevel installation terminal block; NT/L/PE; 4 mm² (2203-6641)
- 2 x Multilevel installation terminal block; L/L; 4 mm² (2203-6642)
- 1 x End and intermediate plate (2203-6692)
- 3 x 2-conductor supply terminal block for distribution boxes; gray; 16 mm² (2016-7601)
- 1 x 2-conductor supply terminal block for distribution boxes; blue; 16 mm² (2016-7604)
- 1 x 2-conductor ground terminal block; green-yellow; 16 mm² (2016-7607)
- 1 x End and intermediate plate (2016-7692)
- 2 x Screwless end stop; 10 mm wide (249-117)
- 15 x Push-in type jumper bar; 2-way (2002-402)
- 2 x Test plug adapter N/L; gray (2003-499)
- 2 x Test plug adapter N; gray (2003-500)
- 2 x Test plug adapter; for 4 mm Ø test plugs (2009-174)
- 1 x Marking strips; white; 0.5 m (2009-110)
- 1 x WMB marking card; 1 ... 50 (793-5566)
- 1 x WMB marking card; L1, L2, L3, N, PE (793-5472)
- 1 x Fiber-tip pen (210-110)

Board Set 821 Series



INSTA-BOX TOPJOB® S; L-BOXX® 102; with operating slots; for Distribution Boards in Buildings

	Bestellnr.	VPE
	821-160	1

Contains:

- 50 x Multilevel installation terminal block; NT/L/PE; 2.5 mm² (2003-7641)
- 10 x Multilevel installation terminal block; L/L; 2.5 mm² (2003-7642)
- 10 x End and intermediate plate (2003-7692)
- 5 x Multilevel installation terminal block; NT/L/PE; 4 mm² (2005-7641)
- 5 x Multilevel installation terminal block; L/L; 4 mm² (2005-7642)
- 5 x End and intermediate plate (2003-7692)
- 9 x 2-conductor supply terminal block for distribution boxes; gray; 16 mm² (2016-7601)
- 3 x 2-conductor supply terminal block for distribution boxes; blue; 16 mm² (2016-7604)
- 3 x 2-conductor ground terminal block; green-yellow; 16 mm² (2016-7607)
- 10 x End and intermediate plate (2016-7692)
- 6 x 1-conductor N-disconnect terminal block; blue; 16 mm² (2016-7714)
- 5 x End and intermediate plate (2016-7792)
- 5 x Screwless end stop; 10 mm wide (249-117)
- 6 x Busbar carrier; with end stop function (2009-305)
- 5 x Busbar carrier; not suitable for use as end stop (2009-304)
- 4 x Busbar; tin-plated; 0.25 m (210-133)
- 4 x N-busbar cover; transparent; 0.25 m (777-303)
- 10 x Staggered jumper; 3-way (2002-473)
- 10 x Staggered jumper; 5-way (2002-475)
- 10 x Staggered jumper; 7-way (2002-477)
- 10 x Push-in type jumper bar; 2-way (2002-402)
- 5 x Push-in type jumper bar; 2-way (2016-402)
- 2 x Test plug; 2 mm Ø (210-136)
- 2 x Testing tap; for max. 2.5 mm² (2009-182)
- 5 x Lock-out; prevents reclosing of slide link; for 2003 Series (2003-7300)
- 5 x Lock-out; prevents reclosing of slide link; for 2002 and 2005 Series (2005-7300)
- 5 x Lock-out; prevents reclosing of slide link; for 2006 and 2016 Series (2006-7300)
- 4 x Marking strips; white; 0.25 m (2009-110)
- 2 x WMB marking card; plain (793-5501)
- 2 x WMB marking card; 1 ... 50 (793-5566)
- 1 x WMB marking card; L1, L2, L3, N, PE (793-5472)
- 1 x Operating tool (2009-310)
- 1 x Fiber-tip pen (210-110)



INSTA-BOX TOPJOB® S; L-BOXX® 102; with operating slots and push-button; for Distribution Boards in Buildings

	Bestellnr.	VPE
	821-161	1

Contains:

- 50 x Multilevel installation terminal block; NT/L/PE; 2.5 mm² (2203-7541)
- 10 x Multilevel installation terminal block; L/L; 2.5 mm² (2203-7542)
- 10 x End and intermediate plate (2203-7692)
- 5 x Multilevel installation terminal block; NT/L/PE; 4 mm² (2205-7541)
- 5 x Multilevel installation terminal block; L/L; 4 mm² (2205-7542)
- 5 x End and intermediate plate (2205-7692)
- 9 x 2-conductor supply terminal block for distribution boxes; gray; 16 mm² (2016-7601)
- 3 x 2-conductor supply terminal block for distribution boxes; blue; 16 mm² (2016-7604)
- 3 x 2-conductor ground terminal block; green-yellow; 16 mm² (2016-7607)
- 10 x End and intermediate plate (2016-7692)
- 6 x 1-conductor N-disconnect terminal block; blue; 16 mm² (2016-7714)
- 5 x End and intermediate plate (2016-7792)
- 5 x Screwless end stop; 10 mm wide (249-117)
- 6 x Busbar carrier; with end stop function (2009-305)
- 5 x Busbar carrier; not suitable for use as end stop (2009-304)
- 4 x Busbar; tin-plated; 0.25 m (210-133)
- 4 x N-busbar cover; transparent; 0.25 m (777-303)
- 10 x Staggered jumper; 3-way (2002-473)
- 10 x Staggered jumper; 5-way (2002-475)
- 10 x Staggered jumper; 7-way (2002-477)
- 10 x Push-in type jumper bar; 2-way (2002-402)
- 5 x Push-in type jumper bar; 2-way (2016-402)
- 2 x Test plug; 2 mm Ø (210-136)
- 2 x Testing tap; for max. 2.5 mm² (2009-182)
- 5 x Lock-out; prevents reclosing of slide link; for 2003 Series (2003-7300)
- 5 x Lock-out; prevents reclosing of slide link; for 2002 and 2005 Series (2005-7300)
- 5 x Lock-out; prevents reclosing of slide link; for 2006 and 2016 Series (2006-7300)
- 4 x Marking strips; white; 0.25 m (2009-110)
- 2 x WMB marking card; plain (793-5566)
- 2 x WMB marking card; 1 ... 50 (793-5501)
- 1 x WMB marking card; L1, L2, L3, N, PE (793-5472)
- 1 x Operating tool (2009-310)
- 1 x Fiber-tip pen (210-110)



INSTA-BOX TOPJOB® S; L-BOXX® 102; with push-button; for Distribution Boards in Buildings

	Bestellnr.	VPE
	821-162	1





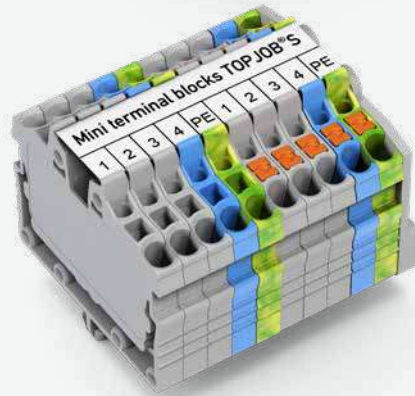
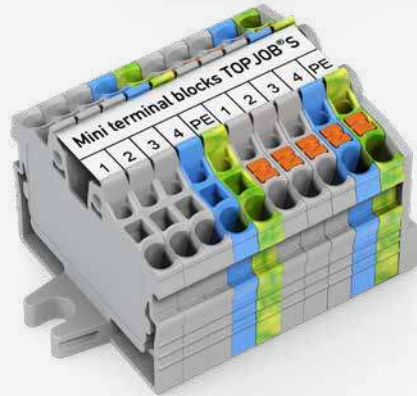
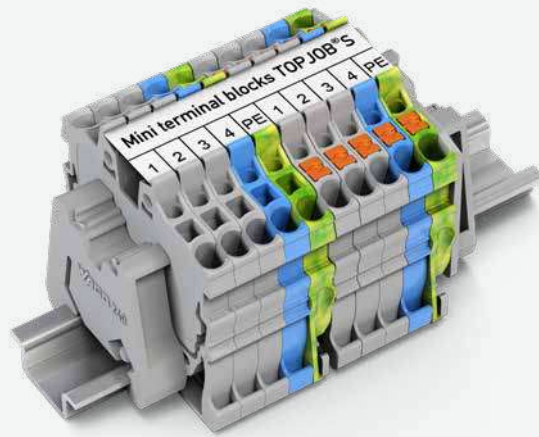



Contains:

- 50 x Multilevel installation terminal block; NT/L/PE; 2.5 mm² (2203-7641)
- 10 x Multilevel installation terminal block; L/L; 2.5 mm² (2203-7642)
- 10 x End and intermediate plate (2203-7692)
- 5 x Multilevel installation terminal block; NT/L/PE; 4 mm² (2205-7641)
- 5 x Multilevel installation terminal block; L/L; 4 mm² (2205-7642)
- 5 x End and intermediate plate (2205-7692)
- 9 x 2-conductor supply terminal block for distribution boxes; gray; 16 mm² (2016-7601)
- 3 x 2-conductor supply terminal block for distribution boxes; blue; 16 mm² (2016-7604)
- 3 x 2-conductor ground terminal block; green-yellow; 16 mm² (2016-7607)
- 10 x End and intermediate plate (2016-7692)
- 6 x 1-conductor N-disconnect terminal block; blue; 16 mm² (2016-7714)
- 5 x End and intermediate plate (2016-7792)
- 5 x Screwless end stop; 10 mm wide (249-117)
- 6 x Busbar carrier; with end stop function (2009-305)
- 5 x Busbar carrier; not suitable for use as end stop (2009-304)
- 4 x Busbar; tin-plated; 0.25 m (210-133)
- 4 x N-busbar cover; transparent; 0.25 m (777-303)
- 10 x Staggered jumper; 3-way (2002-473)
- 10 x Staggered jumper; 5-way (2002-475)
- 10 x Staggered jumper; 7-way (2002-477)
- 10 x Push-in type jumper bar; 2-way (2002-402)
- 5 x Push-in type jumper bar; 2-way (2016-402)
- 2 x Test plug; 2 mm Ø (210-136)
- 2 x Testing tap; for max. 2.5 mm² (2009-182)
- 5 x Lock-out; prevents reclosing of slide link; for 2003 Series (2003-7300)
- 5 x Lock-out; prevents reclosing of slide link; for 2002 and 2005 Series (2005-7300)
- 5 x Lock-out; prevents reclosing of slide link; for 2006 and 2016 Series (2006-7300)
- 4 x Marking strips; white; 0.25 m (2009-110)
- 2 x WMB marking card; plain (793-5566)
- 2 x WMB marking card; 1 ... 50 (793-5501)
- 1 x WMB marking card; L1, L2, L3, N, PE (793-5472)
- 1 x Operating tool (2009-310)
- 1 x Fiber-tip pen (210-110)



WAGO Mini Rail-Mount Terminal Blocks TOPJOB® S

WAGO Mini Rail-Mount Terminal Blocks TOPJOB® S

			Page
	Miniature Through and Ground Conductor Terminal Blocks; with Push-Buttons; for DIN-15 Rail 1 (1.5) mm ² (16 AWG)	2250 Series	282
	Miniature Through and Ground Conductor Terminal Blocks; with Push-Buttons; for DIN-15 Rail 2.5 (4) mm ² (12 AWG)	2252 Series	283
	Miniature Through and Ground Conductor Terminal Blocks; for DIN-15 Rail 1 (1.5) mm ² (16 AWG)	2050 Series	284
	Miniature Through and Ground Conductor Terminal Blocks; for DIN-15 Rail 2.5 (4) mm ² (12 AWG)	2052 Series	285
	Miniature Through Terminal Blocks; with Push-Buttons; with Mounting Flanges and Snap-In Mounting Feet 1 (1.5) mm ² (16 AWG)	2250 Series	286
	Miniature Through Terminal Blocks; with Push-Buttons; with Mounting Flanges and Snap-In Mounting Feet 2.5 (4) mm ² (12 AWG)	2252 Series	288
	Miniature Through Terminal Blocks; with Mounting Flanges and Snap-In Mounting Feet 1 (1.5) mm ² (16 AWG)	2050 Series	290
	Miniature Through Terminal Blocks; with Mounting Flanges and Snap-In Mounting Feet 2.5 (4) mm ² (12 AWG)	2052 Series	292

Miniature Rail-Mount Terminal Blocks TOPJOB® S; with/without push-buttons and with Push-in CAGE CLAMP® 2250 and 2050 Series Description and Installation



Insert ferruled conductors via push-in termination.



Insert fine-stranded conductors via operating tool.



Remove all conductors via operating tool.

4



Insert a jumper (star point jumper) and push down until it hits the backstop.



Insert a jumper (delta jumper) and push down until it hits the backstop.



Marking strip (2009-110) inserted in the marking slot with jumper symbols of the inserted jumper



Snapping a marking strip (2009-110) into a marker slot.



Snapping a WMB marking strip into a marker slot.



Push-in CAGE CLAMP® terminates the following copper conductors:
solid "s"



stranded "st"



fine-stranded "f-st", also with tinned single strands

PUSH-IN CAGE CLAMP®

4



Insert ferruled conductors via push-in termination.



Insert fine-stranded conductors via operating tool.



Remove all conductors via operating tool.



Mounting a terminal strip with snap-in feet into holes.



Terminal strip; with snap-in mounting feet
Snapping a mounting foot (209-120)
(Distance between mounting feet: approx. 20 ... 25 mm)



Terminal strip; with snap-in mounting feet; for DIN-35 rail
(209-120 Mounting Foot)



Mounting and securing a terminal strip directly to the plate via screw-type flanges



Terminal strip; with mounting flanges; screw mounting



Testing with a 2 mm Ø 210-136 Test Plug (max. 42 V).



fine-stranded,
tip-bonded



fine-stranded,
with ferrule
(gastight crimped)



fine-stranded,
with pin terminal
(gastight crimped)

PUSH-IN CAGE CLAMP®

Miniature Through Terminal Block and Ground Conductor Terminal Block TOPJOB® S; with Push-Button; for DIN-15 Rail 1 (1.5) mm²; 2250 Series

Technical Data

0.14 ... 1 (1.5) mm ² ①	24 ... 16 AWG
500 V / 6 kV / 3 ②	300 V, 10 A ③
I _N 13.5 A (17.5 A)	300 V, 10 A ④
Terminal block width: 3.5 mm / 0.138 inch	
9 ... 11 mm / 0.35 ... 0.43 inch	

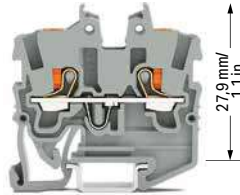

2-conductor miniature through terminal block; with push-button; for DIN-15 rail

Color	Item No.	Pack. Unit
gray ⑤	2250-1201 ④	100
blue ⑤	2250-1204 ③ ④	100
orange ⑤	2250-1202 ④	100
red ⑤	2250-1203 ④	100
black ⑤	2250-1205 ④	100
yellow ⑤	2250-1206 ④	100
brown ⑤	2250-1201/000-014 ④	100

2-conductor miniature ground terminal block; with push-button; for DIN-15 rail

green-yellow ⑤	2250-1207 ④	100
----------------	-------------	-----

Accessories; 2250 Series

Appropriate marking systems:
WMB/WMB Inline/Marking strips

End and intermediate plate; 1.1 mm thick

gray	2050-1291	100 (25)
------	-----------	----------

Push-in type jumper bar; insulated; I_N 14 A; light gray

2-way	2000-402	25
3-way	2000-403	25
4-way	2000-404	25
5-way	2000-405	25
6-way	2000-406	25
7-way	2000-407	25
8-way	2000-408	25
9-way	2000-409	25
10-way	2000-410	25

Push-in type jumper bar; insulated; I_N 14 A; light gray

1 to 3	2000-433	25
1 to 4	2000-434	25
1 to 5	2000-435	25
1 to 6	2000-436	25
1 to 7	2000-437	25
1 to 8	2000-438	25
1 to 9	2000-439	25
1 to 10	2000-440	25

Delta jumper; insulated; I_N = I_N terminal block; light gray

1-2 3-4 5-6	2000-406/020-000	25
-------------	------------------	----

Star point jumper; insulated; I_N = I_N terminal block; light gray

1-3-5	2000-405/011-000	25
-------	------------------	----

- Conductor range: 0.14 ... 1.5 mm² "s+f-st"; Push-in termination: 0.5 ... 1.5 mm² "s" and 0.5 ... 0.75 mm² "insulated ferrules; 10 mm" Depending on the conductor characteristic, a conductor with a smaller cross section can also be inserted via push-in termination.
- 500 V = rated voltage
6 kV = rated impulse voltage
3 = pollution degree (see Section 15)
- Terminal blocks with a blue insulated housing are suitable for Ex i applications.
- Terminal blocks with an Ex mark are suitable for Ex e II applications.
352 V; 13.5 A
12 A jumper (see Section 15)

Please observe the application notes:
Jumpers, from page 182
Testing accessories, from page 176
Marking, from page 684

Approvals and corresponding ratings, visit www.wago.com

Accessories; 2250 Series

Appropriate marking systems:
WMB/WMB Inline/Marking strips

Push-in type wire jumper; insulated; 0.75 mm² conductor cross-section; I_N 9 A

L = 60 mm	2009-402	100 (10)
L = 110 mm	2009-404	100 (10)
L = 250 mm	2009-406	100 (10)

**Modular connector; snaps together; for jumper contact slot
Terminal block width: 5 mm / 0.197 inch
Only for test purposes**

gray	2000-511	100 (25)
------	----------	----------

**Modular connector; snaps together; for jumper contact slot
Only for test purposes**

gray	2000-510	100 (25)
------	----------	----------

Spacer module; snaps together; bridges commoned terminal blocks

gray	2000-549	100 (25)
------	----------	----------

Test plug; with 500 mm cable; 2 mm Ø; max. 42 V

red	210-136	50
-----	---------	----

Marking strip; plain; 11 mm wide; 50 m reel

white	2009-110	1
-------	----------	---

WMB Inline; plain; 2,300 WMB markers (3.5 mm)/reel

white	2009-113	1
-------	----------	---

WMB Marker Card; white; 10 strips with 10 markers/card; for 3.5 mm terminal block width

plain	793-3501	5
-------	----------	---

Accessories; 2250 Series

Appropriate marking systems:
WMB/WMB Inline/Marking strips

Screwless end stop; for DIN-15 rail; 6 mm wide

gray	249-101	25
------	---------	----

Steel DIN-rail; per EN 60715; 15 x 5.5 mm; 1 mm thick; 2 m long

slotted	210-111	10 (1)
unslotted	210-295	10 (1)

Aluminum DIN-rail; similar to EN 60715; 15 x 5.5 mm; 1 mm thick; 2 m long

unslotted	210-296	1
-----------	---------	---

4

Miniature Through Terminal Block and Ground Conductor Terminal Block TOPJOB® S; with Push-Button; for DIN-15 Rail 2.5 (4) mm²; 2252 Series

Technical Data

0.25 ... 2.5 (4) mm² ① | 22 ... 12 AWG

800 V/8 kV/3 ②

I_N 24 A (32 A)

Terminal block width: 5.2 mm / 0.205 inch

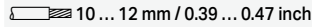
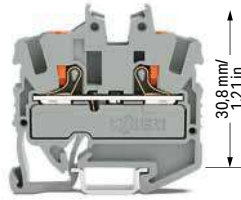
 10 ... 12 mm / 0.39 ... 0.47 inch

 36,5 mm/1.44 in

2-conductor miniature through terminal block; with push-button; for DIN-15 rail

Color	Item No.	Pack. Unit
gray ③	2252-1201 ④	100
blue ③	2252-1204 ③ ④	100
orange ③	2252-1202 ④	100
red ③	2252-1203 ④	100
black ③	2252-1205 ④	100
yellow ③	2252-1206 ④	100
brown ③	2252-1201/000-014 ④	100

2-conductor miniature ground terminal block; with push-button; for DIN-15 rail

green-yellow ③	2252-1207 ④	100
----------------	-------------	-----

Accessories; 2252 Series

Appropriate marking systems:
WMB/WMB Inline/Marking strips

End and intermediate plate; 1.1 mm thick

gray	2052-1291	100 (25)
------	-----------	----------

Insulation stop; 5 pcs/strip; 0.25 ... 0.5 mm²

light gray	2002-171	200 (25)
------------	----------	----------

Insulation stop; 5 pcs/strip; 0.75 ... 1 mm²

dark gray	2002-172	200 (25)
-----------	----------	----------

Push-in type jumper bar; insulated; I_N 25 A; light gray

2-way	2002-402	25
3-way	2002-403	25
4-way	2002-404	25
5-way	2002-405	25
6-way	2002-406	25
7-way	2002-407	25
8-way	2002-408	25
9-way	2002-409	25
10-way	2002-410	25

Delta jumper; insulated; I_N = I_N terminal block; light gray

1-2 3-4 5-6	2002-406/020-000	25
-------------	------------------	----

Star point jumper; insulated; I_N = I_N terminal block; light gray

1-3-5	2002-405/011-000	25
-------	------------------	----

① Conductor range: 0.25 ... 4 mm² "s+f-st"
Push-in termination: 1 ... 4 mm² "s" and 1 ... 2.5 mm² "insulated ferrules, 12 mm"
Depending on the conductor characteristic, a conductor with a smaller cross-section can also be inserted via push-in termination.

② 800 V = rated voltage
8 kV = rated impulse voltage
3 = pollution degree
(see Section 15)

③ Terminal blocks with a blue insulated housing are suitable for Ex i applications.

④ Terminal blocks with an Ex mark are suitable for Ex e II applications.
550 V; 22 A
20 A jumper
(see Section 15)

Please observe the application notes:
Jumpers, from page 182
Testing accessories, from page 177
Marking, from page 684

Approvals and corresponding ratings,
visit www.wago.com

Accessories; 2252 Series

Appropriate marking systems:
WMB/WMB Inline/Marking strips

Push-in type jumper bar; insulated; I_N 25 A; light gray

1 to 3	2002-433	25
1 to 4	2002-434	25
1 to 5	2002-435	25
1 to 6	2002-436	25
1 to 7	2002-437	25
1 to 8	2002-438	25
1 to 9	2002-439	25
1 to 10	2002-440	25

Staggered jumper; insulated; I_N 25 A; light gray

2-way	2002-472	25
3-way	2002-473	25
4-way	2002-474	25
5-way	2002-475	25
6-way	2002-476	25
7-way	2002-477	25
8-way	2002-478	25
9-way	2002-479	25
10-way	2002-480	25
11-way	2002-481	25
12-way	2002-482	25

Customized staggered jumper; insulated; with contact lugs broken off at the factory and circuit printing; I_N 25 A; light gray

1-3	2002-473/011-000	25
1-3-5	2002-475/011-000	25
1-3-5-7	2002-477/011-000	25
1-3-5-7-9	2002-479/011-000	25
1-3-5-7-9-11	2002-481/011-000	25

Continuous jumper; insulated; I_N 25 A; light gray

1-2	2002-400	25
-----	----------	----

Continuous jumper; insulated; I_N 25 A; light gray

1 to 3	2002-423	25
1 to 4	2002-424	25

Continuous jumper; insulated; I_N 25 A; light gray

3-way	2002-413	25
5-way	2002-415	25

Accessories; 2252 Series

Appropriate marking systems:
WMB/WMB Inline/Marking strips

Push-in type wire jumper; insulated; 1.5 mm² conductor cross-section; I_N 18 A

L = 60 mm	2009-412	100 (10)
L = 110 mm	2009-414	100 (10)
L = 250 mm	2009-416	100 (10)

L-type test plug module; snaps together

gray	2002-611	100 (25)
------	----------	----------

L-type spacer module; snaps together; bridges commoned terminal blocks,

gray	2002-649	100 (25)
------	----------	----------

Test plug; with 500 mm cable; 2 mm Ø; max. 42 V

red	210-136	50
-----	---------	----

Test plug adapter; for 4 mm Ø test plug

gray	2009-174	100 (25)
------	----------	----------

Testing tap; for max. 2.5 mm²

gray	2009-182	100 (25)
------	----------	----------

Marking strip; plain; 11 mm wide; 50 m reel

white	2009-110	1
-------	----------	---

WMB Inline; plain; 1,500 WMB markers (5 mm)/reel; stretchable 5 ... 5.2 mm

white	2009-115	1
-------	----------	---

WMB marker card; white; 10 strips with 10 markers/card; stretchable 5 ... 5.2 mm

plain	793-5501	5
-------	----------	---

Screwless end stop; for DIN-15 rail; 6 mm wide

gray	249-101	25
------	---------	----

Steel DIN-rail; per EN 60715; 15 x 5.5 mm; 1 mm thick; 2 m long

slotted	210-111	10 (1)
unslotted	210-295	10 (1)

Aluminum DIN-rail; similar to EN 60715; 15 x 5.5 mm; 1 mm thick; 2 m long

unslotted	210-296	1
-----------	---------	---

Miniature Through Terminal Block and Ground Conductor Terminal Block TOPJOB® S; for DIN-15 Rail

1 (1.5) mm²; 2050 Series

Technical Data	
0.14 ... 1 (1.5) mm ² ①	24 ... 16 AWG
500 V / 6 kV / 3 ②	300 V, 10 A ③
I _N 13.5 A (17.5 A)	300 V, 10 A ④
Terminal block width: 3.5 mm / 0.138 inch	
9 ... 11 mm / 0.35 ... 0.43 inch	



2-conductor miniature through terminal block; for DIN-15 rail

Color	Item No.	Pack. Unit
gray ⑤	2050-1201 ④	100
blue ⑤	2050-1204 ③ ④	100
orange ⑤	2050-1202 ④	100
red ⑤	2050-1203 ④	100
black ⑤	2050-1205 ④	100
yellow ⑤	2050-1206 ④	100
brown ⑤	2050-1201/000-014 ④	100

2-conductor miniature ground terminal block; for DIN-15 rail

green-yellow ⑤	2050-1207 ④	100
----------------	-------------	-----

Accessories; 2050 Series

Appropriate marking systems:
WMB/WMB Inline/Marking strips

End and intermediate plate; 1.1 mm thick

gray	2050-1291	100 (25)
------	-----------	----------

Push-in type jumper bar; insulated; I_N 14 A; light gray

2-way	2000-402	25
3-way	2000-403	25
4-way	2000-404	25
5-way	2000-405	25
6-way	2000-406	25
7-way	2000-407	25
8-way	2000-408	25
9-way	2000-409	25
10-way	2000-410	25

Push-in type jumper bar; insulated; I_N 14 A; light gray

1 to 3	2000-433	25
1 to 4	2000-434	25
1 to 5	2000-435	25
1 to 6	2000-436	25
1 to 7	2000-437	25
1 to 8	2000-438	25
1 to 9	2000-439	25
1 to 10	2000-440	25

Delta jumper; insulated; I_N = I_N terminal block; light gray

1-2 3-4 5-6	2000-406/020-000	25
-------------	------------------	----

Star point jumper; insulated; I_N = I_N terminal block; light gray

1-3-5	2000-405/011-000	25
-------	------------------	----

- Conductor range: 0.14 ... 1.5 mm² "s+f-st"; Push-in termination: 0.5 ... 1.5 mm² "s" and 0.5 ... 0.75 mm² "insulated ferrules; 10 mm" Depending on the conductor characteristic, a conductor with a smaller cross section can also be inserted via push-in termination.
- 500 V = rated voltage
6 kV = rated impulse voltage
3 = pollution degree (see Section 15)
- Terminal blocks with a blue insulated housing are suitable for Ex i applications.
- Terminal blocks with an Ex mark are suitable for Ex e II applications.
352 V; 13.5 A
12 A jumper (see Section 15)

Please observe the application notes:
Jumpers, from page 182
Testing accessories, from page 176
Marking, from page 684

Approvals and corresponding ratings, visit www.wago.com

Accessories; 2050 Series

Appropriate marking systems:
WMB/WMB Inline/Marking strips

Push-in type wire jumper; insulated; 0.75 mm² conductor cross-section; I_N 9 A

L = 60 mm	2009-402	100 (10)
L = 110 mm	2009-404	100 (10)
L = 250 mm	2009-406	100 (10)

Protective warning marker; with black high-voltage symbol; for 5 terminal blocks

yellow	2000-115	100 (25)
--------	----------	----------

Modular connector; snaps together; for jumper contact slot

Terminal block width: 5 mm / 0.197 inch
Only for test purposes

gray	2000-511	100 (25)
------	----------	----------

Modular connector; snaps together; for jumper contact slot

Only for test purposes

gray	2000-510	100 (25)
------	----------	----------

Spacer module; snaps together; bridges commoned terminal blocks

gray	2000-549	100 (25)
------	----------	----------

Test plug; with 500 mm cable; 2 mm Ø; max. 42 V

red	210-136	50
-----	---------	----

Marking strip; plain; 11 mm wide; 50 m reel

white	2009-110	1
-------	----------	---

WMB Inline; plain; 2,300 WMB markers (3.5 mm)/reel

white	2009-113	1
-------	----------	---

WMB Marker Card; white; 10 strips with 10 markers/card; for 3.5 mm terminal block width

plain	793-3501	5
-------	----------	---

Accessories; 2050 Series

Appropriate marking systems:
WMB/WMB Inline/Marking strips

Screwless end stop; for DIN-15 rail; 6 mm wide

gray	249-101	25
------	---------	----

Steel DIN-rail; per EN 60715; 15 x 5.5 mm; 1 mm thick; 2 m long

slotted	210-111	10 (1)
unslotted	210-295	10 (1)

Aluminum DIN-rail; similar to EN 60715; 15 x 5.5 mm; 1 mm thick; 2 m long

unslotted	210-296	1
-----------	---------	---

Miniature Through Terminal Block and Ground Conductor Terminal Block TOPJOB® S; for DIN-15 Rail

2.5 (4) mm²; 2052 Series

Technical Data

0.25 ... 2.5 (4) mm² ① | 22 ... 12 AWG

800 V/8 kV/3 ②

I_N 24 A (32 A)

Terminal block width: 5.2 mm / 0.205 inch

10 ... 12 mm / 0.39 ... 0.47 inch

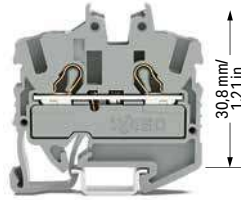

2-conductor miniature through terminal block; for DIN-15 rail

Color	Item No.	Pack. Unit
gray ③	2052-1201 ④	100
blue ③	2052-1204 ③ ④	100
orange ③	2052-1202 ④	100
red ③	2052-1203 ④	100
black ③	2052-1205 ④	100
yellow ③	2052-1206 ④	100
brown ③	2052-1201/000-014 ④	100

2-conductor miniature ground terminal block; for DIN-15 rail

green-yellow ③	2052-1207 ④	100
----------------	-------------	-----

Accessories; 2052 Series

Appropriate marking systems:
WMB/WMB Inline/Marking strips

End and intermediate plate; 1.1 mm thick

gray	2052-1291	100 (25)
------	-----------	----------

Insulation stop; 5 pcs/strip; 0.25 ... 0.5 mm²

light gray	2002-171	200 (25)
------------	----------	----------

Insulation stop; 5 pcs/strip; 0.75 ... 1 mm²

dark gray	2002-172	200 (25)
-----------	----------	----------

Protective warning marker; with black high-voltage symbol; for 5 terminal blocks

yellow	2002-115	100 (25)
--------	----------	----------

Push-in type jumper bar; insulated; I_N 25 A; light gray

2-way	2002-402	25
3-way	2002-403	25
4-way	2002-404	25
5-way	2002-405	25
6-way	2002-406	25
7-way	2002-407	25
8-way	2002-408	25
9-way	2002-409	25
10-way	2002-410	25

① Conductor range: 0.25 ... 4 mm² "s+f-st"
Push-in termination: 1 ... 4 mm² "s" and 1 ... 2.5 mm² "insulated ferrules, 12 mm"
Depending on the conductor characteristic, a conductor with a smaller cross-section can also be inserted via push-in termination.

② 800 V = rated voltage
8 kV = rated impulse voltage
3 = pollution degree
(see Section 15)

③ Terminal blocks with a blue insulated housing are suitable for Ex i applications.

④ Terminal blocks with an Ex mark are suitable for Ex e II applications.
550 V; 22 A
20 A jumper
(see Section 15)

Please observe the application notes:
Jumpers, from page 182
Testing accessories, from page 177
Marking, from page 684Approvals and corresponding ratings,
visit www.wago.com

Accessories; 2052 Series

Appropriate marking systems:
WMB/WMB Inline/Marking stripsPush-in type jumper bar; insulated; I_N 25 A; light gray

1 to 3	2002-433	25
1 to 4	2002-434	25
1 to 5	2002-435	25
1 to 6	2002-436	25
1 to 7	2002-437	25
1 to 8	2002-438	25
1 to 9	2002-439	25
1 to 10	2002-440	25

Staggered jumper; insulated; I_N 25 A; light gray

2-way	2002-472	25
3-way	2002-473	25
4-way	2002-474	25
5-way	2002-475	25
6-way	2002-476	25
7-way	2002-477	25
8-way	2002-478	25
9-way	2002-479	25
10-way	2002-480	25
11-way	2002-481	25
12-way	2002-482	25

Customized staggered jumper; insulated; with contact lugs broken off at the factory and circuit printing; I_N 25 A; light gray

1-3	2002-473/011-000	25
1-3-5	2002-475/011-000	25
1-3-5-7	2002-477/011-000	25
1-3-5-7-9	2002-479/011-000	25
1-3-5-7-9-11	2002-481/011-000	25

Delta jumper; insulated; I_N = I_N terminal block; light gray

1-2 3-4 5-6	2002-406/020-000	25
-------------	------------------	----

Star point jumper; insulated; I_N = I_N terminal block; light gray

1-3-5	2002-405/011-000	25
-------	------------------	----

Continuous jumper; insulated; I_N 25 A; light gray

1-2	2002-400	25
-----	----------	----

Accessories; 2052 Series

Appropriate marking systems:
WMB/WMB Inline/Marking stripsContinuous jumper; insulated; I_N 25 A; light gray

1 to 3	2002-423	25
1 to 4	2002-424	25

Continuous jumper; insulated; I_N 25 A, light gray

3-way	2002-413	25
5-way	2002-415	25

Push-in type wire jumper; insulated; 1.5 mm² conductor cross-section; I_N 18 A

L = 60 mm	2009-412	100 (10)
L = 110 mm	2009-414	100 (10)
L = 250 mm	2009-416	100 (10)

L-type test plug module; snaps together

gray	2002-611	100 (25)
------	----------	----------

L-type spacer module; snaps together; bridges commoned terminal blocks,

gray	2002-649	100 (25)
------	----------	----------

Test plug; with 500 mm cable; 2 mm Ø; max. 42 V

red	210-136	50
-----	---------	----

Test plug adapter; for 4 mm Ø test plug

gray	2009-174	100 (25)
------	----------	----------

Testing tap; for max. 2.5 mm²

gray	2009-182	100 (25)
------	----------	----------

Marking strip; plain; 11 mm wide; 50 m reel

white	2009-110	1
-------	----------	---

WMB Inline; plain; 1,500 WMB markers (5 mm)/reel; stretchable 5 ... 5.2 mm

white	2009-115	1
-------	----------	---

WMB marker card; white; 10 strips with 10 markers/card; stretchable 5 ... 5.2 mm

plain	793-5501	5
-------	----------	---

Screwless end stop; for DIN-15 rail; 6 mm wide

gray	249-101	25
------	---------	----

Steel DIN-rail; per EN 60715; 15 x 5.5 mm; 1 mm thick; 2 m long

slotted	210-111	10 (1)
unslotted	210-295	10 (1)

Aluminum DIN-rail; similar to EN 60715; 15 x 5.5 mm; 1 mm thick; 2 m long

unslotted	210-296	1
-----------	---------	---

Miniature Through Terminal Block TOPJOB® S; with Push-Button; with Mounting Flange 1 (1.5) mm²; 2250 Series

Technical Data

0.14 ... 1 (1.5) mm² ①	24 ... 16 AWG
500 V / 6 kV / 3 ②	300 V, 10 A ③
I _N 13.5 A (17.5 A)	300 V, 10 A ④
Terminal block width: 3.5 mm / 0.138 inch	
9 ... 11 mm / 0.35 ... 0.43 inch	



Dimensions (in mm):

Modular terminal blocks and terminal strips with mounting flanges
L = (pole no. x 3.5 mm) + 4.3 mm + 6.1 mm

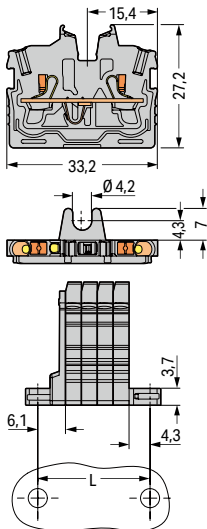

2-conductor miniature through terminal block; with push-button; end terminal block with mounting flange; for screw or similar mounting types; 4.2 mm mounting hole diameter; with mounting foot (209-123) also for DIN-35 rail

Color	Item No.	Pack. Unit
gray ⑤	2250-301 ④	100
blue ⑤	2250-304 ③ ④	100
orange ⑤	2250-302 ④	100
red ⑤	2250-303 ④	100
black ⑤	2250-305 ④	100
yellow ⑤	2250-306 ④	100
brown ⑤	2250-301/000-014 ④	100
green-yellow ⑤	2250-307 ④	100

2-conductor miniature through terminal block; with push-button; center terminal block; without snap-in mounting foot; without mounting flange; for 0.6 ... 1.2 mm plate thickness; required between end plate and end terminal block for terminal strips with mounting flanges

Color	Item No.	Pack. Unit
gray ⑤	2250-321 ④	100
blue ⑤	2250-324 ③ ④	100
orange ⑤	2250-322 ④	100
red ⑤	2250-323 ④	100
black ⑤	2250-325 ④	100
yellow ⑤	2250-326 ④	100
brown ⑤	2250-321/000-014 ④	100
green-yellow ⑤	2250-327 ④	100

- Conductor range: 0.14 ... 1.5 mm² "s+f-st"; Push-in termination: 0.5 ... 1.5 mm² "s" and 0.5 ... 0.75 mm² "insulated ferrules; 10 mm" Depending on the conductor characteristic, a conductor with a smaller cross section can also be inserted via push-in termination.
- 500 V = rated voltage
6 kV = rated impulse voltage
3 = pollution degree (see Section 15)
- Terminal blocks with a blue insulated housing are suitable for Ex i applications.
- Terminal blocks with an Ex mark are suitable for Ex e II applications.
352 V; 13.5 A
12 A jumper (see Section 15)

Please observe the application notes:
Jumpers, from page 182
Testing accessories, from page 176
Marking, from page 684

Approvals and corresponding ratings, visit www.wago.com

Accessories; 2250 Series

Appropriate marking systems:
WMB/WMB Inline/Marking strips

End plate; with mounting flange; 1.3 mm thick

gray	2050-381	100 (25)
------	----------	----------

Push-in type jumper bar; insulated; I_N 14 A; light gray

2-way	2000-402	25
3-way	2000-403	25
4-way	2000-404	25
5-way	2000-405	25
6-way	2000-406	25
7-way	2000-407	25
8-way	2000-408	25
9-way	2000-409	25
10-way	2000-410	25

Push-in type jumper bar; insulated; I_N 14 A; light gray

1 to 3	2000-433	25
1 to 4	2000-434	25
1 to 5	2000-435	25
1 to 6	2000-436	25
1 to 7	2000-437	25
1 to 8	2000-438	25
1 to 9	2000-439	25
1 to 10	2000-440	25

Delta jumper; insulated; I_N = I_N terminal block; light gray

1-2 3-4 5-6	2000-406/020-000	25
-------------	------------------	----

Star point jumper; insulated; I_N = I_N terminal block; light gray

1-3-5	2000-405/011-000	25
-------	------------------	----

Push-in type wire jumper; insulated; 0.75 mm² conductor cross-section; I_N 9 A

L = 60 mm	2009-402	100 (10)
L = 110 mm	2009-404	100 (10)
L = 250 mm	2009-406	100 (10)

Accessories; 2250 Series

Appropriate marking systems:
WMB/WMB Inline/Marking strips

Modular connector; snaps together; for jumper contact slot
Terminal block width: 5 mm / 0.197 inch
Only for test purposes

gray	2000-511	100 (25)
------	----------	----------

Modular connector; snaps together; for jumper contact slot
Only for test purposes

gray	2000-510	100 (25)
------	----------	----------

Spacer module; snaps together; bridges commoned terminal blocks

gray	2000-549	100 (25)
------	----------	----------

Test plug; with 500 mm cable; 2 mm Ø; max. 42 V

red	210-136	50
-----	---------	----

Marking strip; plain; 11 mm wide; 50 m reel

white	2009-110	1
-------	----------	---

WMB Inline; plain; 2,300 WMB markers (3.5 mm)/reel

white	2009-113	1
-------	----------	---

WMB Marker Card; white; 10 strips with 10 markers/card; for 3.5 mm terminal block width

plain	793-3501	5
-------	----------	---

Mounting foot with screw; for DIN-35 rail; can be screwed on terminal blocks with mounting flange; 6.4 mm wide

gray	209-123	25
------	---------	----

Mounting adapter; for DIN-35 rail; can be used as end plate; 6.5 mm wide

gray	209-137	25
------	---------	----

Miniature Through Terminal Block TOPJOB® S; with Push-Button; with Snap-In Mounting Foot 1 (1.5) mm²; 2250 Series

Technical Data

0.14 ... 1 (1.5) mm ² ①	24 ... 16 AWG
500 V / 6 kV / 3 ②	300 V, 10 A ④
I _N 13.5 A (17.5 A)	300 V, 10 A ④
Terminal block width: 3.5 mm / 0.138 inch	
9 ... 11 mm / 0.35 ... 0.43 inch	



Dimensions (in mm):

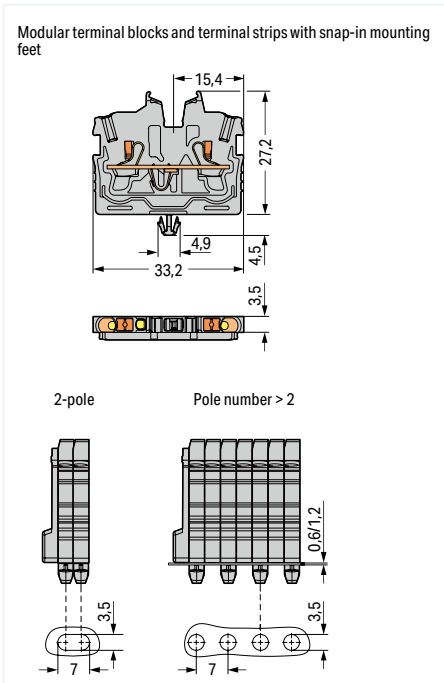

2-conductor miniature through terminal block; with push-button; with snap-in mounting foot; for 0.6 ... 1.2 mm plate thickness; 3.5 mm mounting hole diameter; also for aluminum DIN-rail (210-154) or with mounting foot (209-120) for DIN-35 rail

Color	Item No.	Pack. Unit
gray ④	2250-311 ④	100
blue ④	2250-314 ③ ④	100
orange ④	2250-312 ④	100
red ④	2250-313 ④	100
black ④	2250-315 ④	100
yellow ④	2250-316 ④	100
brown ④	2250-311/000-014 ④	100
green-yellow ④	2250-317 ④	100

2-conductor miniature through terminal block; with push-button; center terminal block; without snap-in mounting foot; without mounting flange; for 0.6 ... 1.2 mm plate thickness; required between end plate and end terminal block for terminal strips with mounting flanges

gray ④	2250-321 ④	100
blue ④	2250-324 ③ ④	100
orange ④	2250-322 ④	100
red ④	2250-323 ④	100
green-yellow ④	2250-327 ④	100

- Conductor range: 0.14 ... 1.5 mm² "s+f-st"; Push-in termination: 0.5 ... 1.5 mm² "s" and 0.5 ... 0.75 mm² "insulated ferrules; 10 mm" Depending on the conductor characteristic, a conductor with a smaller cross section can also be inserted via push-in termination.
- 500 V = rated voltage
6 kV = rated impulse voltage
3 = pollution degree (see Section 15)
- Terminal blocks with a blue insulated housing are suitable for Ex i applications.
- Terminal blocks with an Ex mark are suitable for Ex e II applications.
352 V; 13.5 A
12 A jumper (see Section 15)

Please observe the application notes:
Jumpers, from page 182
Testing accessories, from page 176
Marking, from page 684

Approvals and corresponding ratings, visit www.wago.com

Accessories; 2250 Series

Appropriate marking systems:
WMB/WMB Inline/Marking strips

End plate; for terminal blocks with snap-in mounting foot; 3.4 mm thick

gray	2050-391	100 (25)
------	----------	----------

Push-in type jumper bar; insulated; I_N 14 A; light gray

2-way	2000-402	25
3-way	2000-403	25
4-way	2000-404	25
5-way	2000-405	25
6-way	2000-406	25
7-way	2000-407	25
8-way	2000-408	25
9-way	2000-409	25
10-way	2000-410	25

Push-in type jumper bar; insulated; I_N 14 A; light gray

1 to 3	2000-433	25
1 to 4	2000-434	25
1 to 5	2000-435	25
1 to 6	2000-436	25
1 to 7	2000-437	25
1 to 8	2000-438	25
1 to 9	2000-439	25
1 to 10	2000-440	25

Delta jumper; insulated; I_N = I_N terminal block; light gray

1-2 3-4 5-6	2000-406/020-000	25
-------------	------------------	----

Star point jumper; insulated; I_N = I_N terminal block; light gray

1-3-5	2000-405/011-000	25
-------	------------------	----

Push-in type wire jumper; insulated; 0.75 mm² conductor cross-section; I_N 9 A

L = 60 mm	2009-402	100 (10)
L = 110 mm	2009-404	100 (10)
L = 250 mm	2009-406	100 (10)

Accessories; 2250 Series

Appropriate marking systems:
WMB/WMB Inline/Marking strips

Modular connector; snaps together; for jumper contact slot
Terminal block width: 5 mm / 0.197 inch
Only for test purposes

gray	2000-511	100 (25)
------	----------	----------

Modular connector; snaps together; for jumper contact slot
Only for test purposes

gray	2000-510	100 (25)
------	----------	----------

Spacer module; snaps together; bridges commoned terminal blocks

gray	2000-549	100 (25)
------	----------	----------

Test plug; with 500 mm cable; 2 mm Ø; max. 42 V

red	210-136	50
-----	---------	----

Marking strip; plain; 11 mm wide; 50 m reel

white	2009-110	1
-------	----------	---

WMB Inline; plain; 2,300 WMB markers (3.5 mm)/reel

white	2009-113	1
-------	----------	---

WMB Marker Card; white; 10 strips with 10 markers/card; for 3.5 mm terminal block width

plain	793-3501	5
-------	----------	---

Aluminum DIN-rail; 1000 mm long; 18 mm wide; 7 mm high

	210-154	1
--	---------	---

Plastic end stop; with WSB marker slot; for aluminum DIN-rail (210-154); 6 mm wide

	209-122	25
--	---------	----

Mounting foot; for DIN-35 rail; snaps onto terminal blocks with snap-in mounting foot; 6.4 mm wide

gray	209-120	25
------	---------	----

Mounting screw; for mounting foot (209-120)

	209-119	500 (50)
--	---------	----------

Mounting adapter; for DIN-35 rail; can be used as end plate; 6.5 mm wide

gray	209-137	25
------	---------	----

Miniature Through Terminal Block TOPJOB® S; with Push-Button; with Mounting Flange

2.5 (4) mm²; 2252 Series

Technical Data

0.25 ... 2.5 (4) mm² ① | 22 ... 12 AWG

800 V/8 kV/3 ②

I_N 24 A (32 A)

Terminal block width: 5.2 mm / 0.205 inch

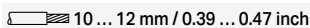
 10 ... 12 mm / 0.39 ... 0.47 inch

4

Dimensions in mm

Modular terminal blocks and terminal strips with mounting flanges
L = (pole no. x 5.2 mm) + 4.3 mm + 6.7 mm

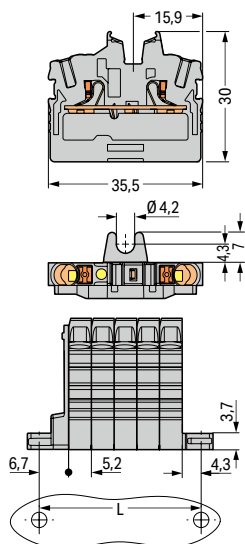

2-conductor miniature through terminal block; with push-button; end terminal block with mounting flange; for screw or similar mounting types; 4.2 mm mounting hole diameter; with mounting foot (209-123) also for DIN-35 rail

Color	Item No.	Pack. Unit
gray ⑤	2252-301 ④	100
blue ⑤	2252-304 ③ ④	100
orange ⑤	2252-302 ④	100
red ⑤	2252-303 ④	100
black ⑤	2252-305 ④	100
yellow ⑤	2252-306 ④	100
brown ⑤	2252-301/000-014 ④	100
green-yellow ⑤	2252-307 ④	100

2-conductor miniature through terminal block; with push-button; Center terminal block; without snap-in mounting foot; without mounting flange; for 0.6 ... 1.2 mm plate thickness; required between end plate and end terminal block for terminal strips with mounting flanges

gray ⑤	2252-321 ④	100
blue ⑤	2252-324 ③ ④	100
orange ⑤	2252-322 ④	100
red ⑤	2252-323 ④	100
black ⑤	2252-325 ④	100
yellow ⑤	2252-326 ④	100
brown ⑤	2252-321/000-014 ④	100
green-yellow ⑤	2252-327 ④	100

① Conductor range: 0.25 ... 4 mm² "s+f-st"
Push-in termination: 1 ... 4 mm² "s" and 1 ... 2.5 mm² "insulated ferrules, 12 mm"
Depending on the conductor characteristic, a conductor with a smaller cross-section can also be inserted via push-in termination.

② 800 V = rated voltage
8 kV = rated impulse voltage
3 = pollution degree (see Section 15)

③ Terminal blocks with a blue insulated housing are suitable for Ex i applications.

④ Terminal blocks with an Ex mark are suitable for Ex e II applications.
550 V; 22 A
20 A jumper (see Section 15)

Please observe the application notes:
Jumpers, from page 182
Testing accessories, from page 177
Marking, from page 684

Approvals and corresponding ratings, visit www.wago.com

Accessories; 2252 Series

Appropriate marking systems:
WMB/WMB Inline/Marking strips

End plate; with mounting flange; 1.3 mm thick

gray 2052-381 100 (25)



Insulation stop; 5 pcs/strip; 0.25 ... 0.5 mm²

light gray 2002-171 200 (25)



Insulation stop; 5 pcs/strip; 0.75 ... 1 mm²

dark gray 2002-172 200 (25)



Push-in type jumper bar; insulated; I_N 25 A; light gray

2-way	2002-402	25
3-way	2002-403	25
4-way	2002-404	25
5-way	2002-405	25
6-way	2002-406	25
7-way	2002-407	25
8-way	2002-408	25
9-way	2002-409	25
10-way	2002-410	25



Push-in type jumper bar; insulated; I_N 25 A; light gray

1 to 3	2002-433	25
1 to 4	2002-434	25
1 to 5	2002-435	25
1 to 6	2002-436	25
1 to 7	2002-437	25
1 to 8	2002-438	25
1 to 9	2002-439	25
1 to 10	2002-440	25



Delta jumper; insulated; I_N = I_N terminal block; light gray

1-2 3-4 5-6 2002-406/020-000 25



Star point jumper; insulated; I_N = I_N terminal block; light gray

1-3-5 2002-405/011-000 25



Accessories; 2252 Series

Appropriate marking systems:
WMB/WMB Inline/Marking strips

Continuous jumper; insulated; I_N 25 A; light gray

1-2 2002-400 25



Continuous jumper; insulated; I_N 25 A; light gray

1 to 3 2002-423 25



1 to 4 2002-424 25

Continuous jumper; insulated; I_N 25 A; light gray

3-way 2002-413 25



5-way 2002-415 25

Staggered jumper; insulated; I_N 25 A; light gray

2-way 2002-472 25



3-way 2002-473 25

4-way 2002-474 25

5-way 2002-475 25

6-way 2002-476 25

7-way 2002-477 25

8-way 2002-478 25

9-way 2002-479 25

10-way 2002-480 25

11-way 2002-481 25

12-way 2002-482 25

Push-in type wire jumper; insulated; 1.5 mm² conductor cross-section; I_N 18 A

L = 60 mm 2009-412 100 (10)

L = 110 mm 2009-414 100 (10)

L = 250 mm 2009-416 100 (10)

L-type test plug module; snaps together

gray 2002-611 100 (25)



Marking strip; plain; 11 mm wide; 50 m reel

white 2009-110 1



WMB Inline; plain; 1,500 WMB markers (5 mm)/reel; stretchable 5 ... 5.2 mm

white 2009-115 1



WMB marker card; white; 10 strips with 10 markers/card; stretchable 5 ... 5.2 mm

plain 793-5501 5



Mounting foot with screw; for DIN-35 rail; can be screwed on terminal blocks with mounting flange; 6.4 mm wide

gray 209-123 25



Mounting adapter; for DIN-35 rail; can be used as an end stop; 6.5 mm wide

gray 209-137 25



Miniature Through Terminal Block TOPJOB® S; with Push-Button; with Snap-In Mounting Foot 2.5 (4) mm²; 2252 Series

Technical Data

0.25 ... 2.5 (4) mm² ① | 22 ... 12 AWG
 800 V/8 kV/3 ②
 I_N 24 A (32 A)
 Terminal block width: 5.2 mm / 0.205 inch
 10 ... 12 mm / 0.39 ... 0.47 inch



Dimensions in mm

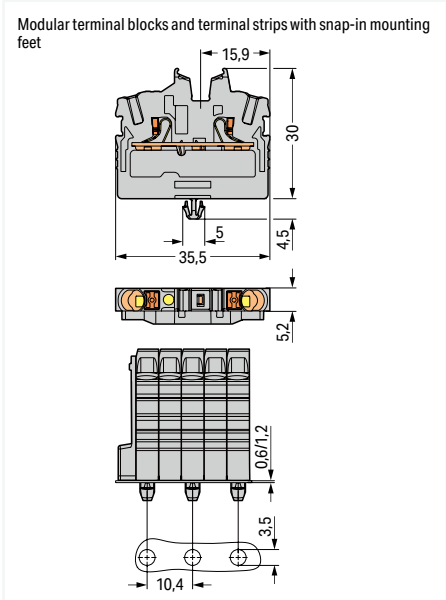

2-conductor miniature through terminal block; with push-button on one side; with snap-in mounting foot; for 0.6 ... 1.2 mm plate thickness; 3.5 mm mounting hole diameter; also for aluminum DIN-rail (210-154) or with mounting foot (209-120) for DIN-35 rail

Color	Item No.	Pack. Unit
gray ⊕	2252-311 ④	100
blue ⊕	2252-314 ③ ④	100
orange ⊕	2252-312 ④	100
red ⊕	2252-313 ④	100
black ⊕	2252-315 ④	100
yellow ⊕	2252-316 ④	100
brown ⊕	2252-311/000-014 ④	100
green-yellow ⊕	2252-317 ④	100

2-conductor miniature through terminal block; with push-button; Center terminal block; without snap-in mounting foot; without mounting flange; for 0.6 ... 1.2 mm plate thickness; required between end plate and end terminal block for terminal strips with mounting flanges

gray ⊕	2252-321 ④	100
blue ⊕	2252-324 ③ ④	100
orange ⊕	2252-322 ④	100
red ⊕	2252-323 ④	100
black ⊕	2252-325 ④	100
yellow ⊕	2252-326 ④	100
brown ⊕	2252-321/000-014 ④	100
green-yellow ⊕	2252-327 ④	100

- Conductor range: 0.25 ... 4 mm² "s+f-st"
 Push-in termination: 1 ... 4 mm² "s" and 1 ... 2.5 mm² "insulated ferrules, 12 mm"
 Depending on the conductor characteristic, a conductor with a smaller cross-section can also be inserted via push-in termination.
- 800 V = rated voltage
 8 kV = rated impulse voltage
 3 = pollution degree (see Section 15)
- Terminal blocks with a blue insulated housing are suitable for Ex i applications.
- Terminal blocks with an Ex mark are suitable for Ex e II applications.
 550 V; 22 A
 20 A jumper (see Section 15)

Please observe the application notes:
 Jumpers, from page 182
 Testing accessories, from page 177
 Marking, from page 684

Approvals and corresponding ratings, visit www.wago.com

Accessories; 2252 Series

Appropriate marking systems:
 WMB/WMB Inline/Marking strips

End plate; for terminal blocks with snap-in mounting foot; 3.4 mm thick

gray	2052-391	100 (25)
------	----------	----------

Insulation stop; 5 pcs/strip; 0.25 ... 0.5 mm²

light gray	2002-171	200 (25)
------------	----------	----------

Insulation stop; 5 pcs/strip; 0.75 ... 1 mm²

dark gray	2002-172	200 (25)
-----------	----------	----------

Push-in type jumper bar; insulated; I_N 25 A; light gray

2-way	2002-402	25
3-way	2002-403	25
4-way	2002-404	25
5-way	2002-405	25
6-way	2002-406	25
7-way	2002-407	25
8-way	2002-408	25
9-way	2002-409	25
10-way	2002-410	25

Push-in type jumper bar; insulated; I_N 25 A; light gray

1 to 3	2002-433	25
1 to 4	2002-434	25
1 to 5	2002-435	25
1 to 6	2002-436	25
1 to 7	2002-437	25
1 to 8	2002-438	25
1 to 9	2002-439	25
1 to 10	2002-440	25

Delta jumper; insulated; I_N = I_N terminal block; light gray

1-2 3-4 5-6	2002-406/020-000	25
-------------	------------------	----

Star point jumper; insulated; I_N = I_N terminal block; light gray

1-3-5	2002-405/011-000	25
-------	------------------	----

Accessories; 2252 Series

Appropriate marking systems:
 WMB/WMB Inline/Marking strips

Continuous jumper; insulated; I_N 25 A; light gray

1-2	2002-400	25
-----	----------	----

Continuous jumper; insulated; I_N 25 A; light gray

1 to 3	2002-423	25
1 to 4	2002-424	25

Continuous jumper; insulated; I_N 25 A; light gray

3-way	2002-413	25
5-way	2002-415	25

Staggered jumper; insulated; I_N 25 A; light gray

2-way	2002-472	25
3-way	2002-473	25
4-way	2002-474	25

5-way
 2002-475 | 25 |

6-way
 2002-476 | 25 |

7-way
 2002-477 | 25 |

8-way
 2002-478 | 25 |

9-way
 2002-479 | 25 |

10-way
 2002-480 | 25 |

11-way
 2002-481 | 25 |

12-way
 2002-482 | 25 |

Push-in type wire jumper; insulated; 1.5 mm² conductor cross-section; I_N 18 A

L = 60 mm	2009-412	100 (10)
L = 110 mm	2009-414	100 (10)
L = 250 mm	2009-416	100 (10)

L-type test plug module; snaps together

gray	2002-611	100 (25)
------	----------	----------

WMB marker card; white; 10 strips with 10 markers/card; stretchable 5 ... 5.2 mm

plain	793-5501	5
-------	----------	---

Aluminum DIN-rail; 1000 mm long; 18 mm wide; 7 mm high

	210-154	1
--	---------	---

Plastic end stop; with WSB marker slot; for aluminum DIN-rail (210-154); 6 mm wide

	209-122	25
--	---------	----

Mounting foot; for DIN-35 rail; snaps onto terminal blocks with snap-in mounting foot; 6.4 mm wide

gray	209-120	25
------	---------	----

Mounting screw; for mounting foot (209-120)

	209-119	500 (50)
--	---------	----------

Mounting adapter; for DIN-35 rail; can be used as an end stop; 6.5 mm wide

gray	209-137	25
------	---------	----

Miniature Through Terminal Block TOPJOB® S; with Mounting Flange 1 (1.5 mm²; 2050 Series

Technical Data

0.14 ... 1 (1.5) mm ² ①	24 ... 16 AWG
500 V / 6 kV / 3 ②	300 V, 10 A ③
I _N 13.5 A (17.5 A)	300 V, 10 A ④
Terminal block width: 3.5 mm / 0.138 inch	
9 ... 11 mm / 0.35 ... 0.43 inch	



Dimensions (in mm):

Modular terminal blocks and terminal strips with mounting flanges
L = (pole no. x 3.5 mm) + 4.3 mm + 6.1 mm

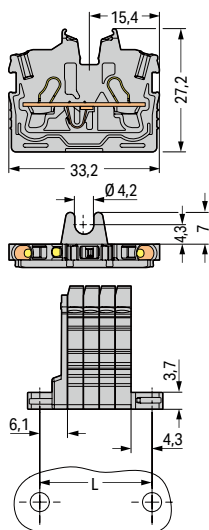

2-conductor miniature through terminal block; with mounting flange; for screw or similar mounting types; 4.2 mm mounting hole diameter; with mounting foot (209-123) also for DIN-35 rail

Color	Item No.	Pack. Unit
gray ⑤	2050-301 ④	100
blue ⑤	2050-304 ③ ④	100
orange ⑤	2050-302 ④	100
red ⑤	2050-303 ④	100
black ⑤	2050-305 ④	100
yellow ⑤	2050-306 ④	100
brown ⑤	2050-301/000-014 ④	100
green-yellow ⑤	2050-307 ④	100

2-conductor miniature through terminal block; center terminal block; without snap-in mounting foot; without mounting flange; for 0.6 ... 1.2 mm plate thickness; required between end plate and end terminal block for terminal strips with mounting flanges

Color	Item No.	Pack. Unit
gray ⑤	2050-321 ④	100
blue ⑤	2050-324 ③ ④	100
orange ⑤	2050-322 ④	100
red ⑤	2050-323 ④	100
black ⑤	2050-325 ④	100
yellow ⑤	2050-326 ④	100
brown ⑤	2050-321/000-014 ④	100
green-yellow ⑤	2050-327 ④	100

- Conductor range: 0.14 ... 1.5 mm² "s+f-st"; Push-in termination: 0.5 ... 1.5 mm² "s" and 0.5 ... 0.75 mm² "insulated ferrules; 10 mm" Depending on the conductor characteristic, a conductor with a smaller cross section can also be inserted via push-in termination.
- 500 V = rated voltage
6 kV = rated impulse voltage
3 = pollution degree (see Section 15)
- Terminal blocks with a blue insulated housing are suitable for Ex i applications.
- Terminal blocks with an Ex mark are suitable for Ex e II applications.
352 V; 13.5 A
12 A jumper (see Section 15)

Please observe the application notes:
Jumpers, from page 182
Testing accessories, from page 176
Marking, from page 684

Approvals and corresponding ratings, visit www.wago.com

Accessories; 2050 Series

Appropriate marking systems:
WMB/WMB Inline/Marking strips

End plate; with mounting flange; 1.3 mm thick

gray	2050-381	100 (25)
------	----------	----------

Push-in type jumper bar; insulated; I_N 14 A; light gray

2-way	2000-402	25
3-way	2000-403	25
4-way	2000-404	25
5-way	2000-405	25
6-way	2000-406	25
7-way	2000-407	25
8-way	2000-408	25
9-way	2000-409	25
10-way	2000-410	25

Push-in type jumper bar; insulated; I_N 14 A; light gray

1 to 3	2000-433	25
1 to 4	2000-434	25
1 to 5	2000-435	25
1 to 6	2000-436	25
1 to 7	2000-437	25
1 to 8	2000-438	25
1 to 9	2000-439	25
1 to 10	2000-440	25

Delta jumper; insulated; I_N = I_N terminal block; light gray

1-2 3-4 5-6	2000-406/020-000	25
-------------	------------------	----

Star point jumper; insulated; I_N = I_N terminal block; light gray

1-3-5	2000-405/011-000	25
-------	------------------	----

Push-in type wire jumper; insulated; 0.75 mm² conductor cross-section; I_N 9 A

L = 60 mm	2009-402	100 (10)
L = 110 mm	2009-404	100 (10)
L = 250 mm	2009-406	100 (10)

Protective warning marker; with black high-voltage symbol; for 5 terminal blocks

yellow	2000-115	100 (25)
--------	----------	----------

Accessories; 2050 Series

Appropriate marking systems:
WMB/WMB Inline/Marking strips

Modular connector; snaps together; for jumper contact slot
Terminal block width: 5 mm / 0.197 inch
Only for test purposes

gray	2000-511	100 (25)
------	----------	----------

Modular connector; snaps together; for jumper contact slot
Only for test purposes

gray	2000-510	100 (25)
------	----------	----------

Spacer module; snaps together; bridges commoned terminal blocks

gray	2000-549	100 (25)
------	----------	----------

Test plug; with 500 mm cable; 2 mm Ø; max. 42 V

red	210-136	50
-----	---------	----

Marking strip; plain; 11 mm wide; 50 m reel

white	2009-110	1
-------	----------	---

WMB Inline; plain; 2,300 WMB markers (3.5 mm)/reel

white	2009-113	1
-------	----------	---

WMB Marker Card; white; 10 strips with 10 markers/card; for 3.5 mm terminal block width

plain	793-3501	5
-------	----------	---

Mounting foot with screw; for DIN-35 rail; can be screwed on terminal blocks with mounting flange; 6.4 mm wide

gray	209-123	25
------	---------	----

Mounting adapter; for DIN-35 rail; can be used as end plate; 6.5 mm wide

gray	209-137	25
------	---------	----

Miniature Through Terminal Block TOPJOB® S; with Snap-In Mounting Foot

1 (1.5) mm²; 2050 Series

Technical Data

0.14 ... 1 (1.5) mm ² ①	24 ... 16 AWG
500 V / 6 kV / 3 ②	300 V, 10 A ④
I _N 13.5 A (17.5 A)	300 V, 10 A ④
Terminal block width: 3.5 mm / 0.138 inch	
9 ... 11 mm / 0.35 ... 0.43 inch	



Dimensions (in mm):

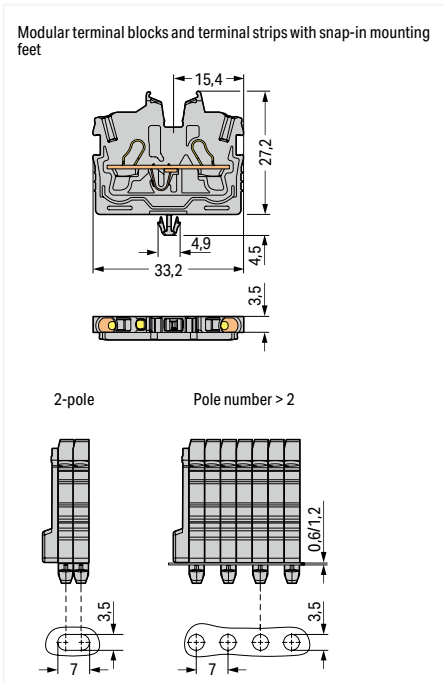

2-conductor miniature through terminal block; with snap-in mounting foot; for 0.6 ... 1.2 mm plate thickness; 3.5 mm mounting hole diameter; also for aluminum DIN-rail (210-154) or with mounting foot (209-120) for DIN-35 rail

Color	Item No.	Pack. Unit
gray ④	2050-311 ④	100
blue ④	2050-314 ③ ④	100
orange ④	2050-312 ④	100
red ④	2050-313 ④	100
black ④	2050-315 ④	100
yellow ④	2050-316 ④	100
brown ④	2050-311/000-014 ④	100
green-yellow ④	2050-317 ④	100

2-conductor miniature through terminal block; center terminal block; without snap-in mounting foot; without mounting flange; for 0.6 ... 1.2 mm plate thickness; required between end plate and end terminal block for terminal strips with mounting flanges

Color	Item No.	Pack. Unit
gray ④	2050-321 ④	100
blue ④	2050-324 ③ ④	100
orange ④	2050-322 ④	100
red ④	2050-323 ④	100
black ④	2050-325 ④	100
green-yellow ④	2050-327 ④	100

① Conductor range: 0.14 ... 1.5 mm² "s+f-st"; Push-in termination: 0.5 ... 1.5 mm² "s" and 0.5 ... 0.75 mm² "insulated ferrules; 10 mm" Depending on the conductor characteristic, a conductor with a smaller cross section can also be inserted via push-in termination.

② 500 V = rated voltage
6 kV = rated impulse voltage
3 = pollution degree (see Section 15)

③ Terminal blocks with a blue insulated housing are suitable for Ex i applications.

④ Terminal blocks with an Ex mark are suitable for Ex e II applications.
352 V; 13.5 A
12 A jumper (see Section 15)

Please observe the application notes:
Jumpers, from page 182
Testing accessories, from page 176
Marking, from page 684

Approvals and corresponding ratings, visit www.wago.com

Accessories; 2050 Series

Appropriate marking systems:
WMB/WMB Inline/Marking strips

End plate; for terminal blocks with snap-in mounting foot; 3.4 mm thick

gray	2050-391	100 (25)
------	----------	----------

Push-in type jumper bar; insulated; I_N 14 A; light gray

2-way	2000-402	25
3-way	2000-403	25
4-way	2000-404	25
5-way	2000-405	25
6-way	2000-406	25
7-way	2000-407	25
8-way	2000-408	25
9-way	2000-409	25
10-way	2000-410	25

Push-in type jumper bar; insulated; I_N 14 A; light gray

1 to 3	2000-433	25
1 to 4	2000-434	25
1 to 5	2000-435	25
1 to 6	2000-436	25
1 to 7	2000-437	25
1 to 8	2000-438	25
1 to 9	2000-439	25
1 to 10	2000-440	25

Delta jumper; insulated; I_N = I_N terminal block; light gray

1-2 3-4 5-6	2000-406/020-000	25
-------------	------------------	----

Star point jumper; insulated; I_N = I_N terminal block; light gray

1-3-5	2000-405/011-000	25
-------	------------------	----

Push-in type wire jumper; insulated; 0.75 mm² conductor cross-section; I_N 9 A

L = 60 mm	2009-402	100 (10)
L = 110 mm	2009-404	100 (10)
L = 250 mm	2009-406	100 (10)

Protective warning marker; with black high-voltage symbol; for 5 terminal blocks

yellow	2000-115	100 (25)
--------	----------	----------

Accessories; 2050 Series

Appropriate marking systems:
WMB/WMB Inline/Marking strips

Modular connector; snaps together; for jumper contact slot
Terminal block width: 5 mm / 0.197 inch
Only for test purposes

gray	2000-511	100 (25)
------	----------	----------

Modular connector; snaps together; for jumper contact slot
Only for test purposes

gray	2000-510	100 (25)
------	----------	----------

Spacer module; snaps together; bridges commoned terminal blocks

gray	2000-549	100 (25)
------	----------	----------

Test plug; with 500 mm cable; 2 mm Ø; max. 42 V

red	210-136	50
-----	---------	----

Marking strip; plain; 11 mm wide; 50 m reel

white	2009-110	1
-------	----------	---

WMB Inline; plain; 2,300 WMB markers (3.5 mm)/reel

white	2009-113	1
-------	----------	---

WMB Marker Card; white; 10 strips with 10 markers/card; for 3.5 mm terminal block width

plain	793-3501	5
-------	----------	---

Aluminum DIN-rail; 1000 mm long; 18 mm wide; 7 mm high

	210-154	1
--	---------	---

Plastic end stop; with WSB marker slot; for aluminum DIN-rail (210-154); 6 mm wide

	209-122	25
--	---------	----

Mounting foot; for DIN-35 rail; snaps onto terminal blocks with snap-in mounting foot; 6.4 mm wide

gray	209-120	25
------	---------	----

Mounting screw; for mounting foot (209-120)

	209-119	500 (50)
--	---------	----------

Mounting adapter; for DIN-35 rail; can be used as end plate; 6.5 mm wide

gray	209-137	25
------	---------	----

Miniature Through Terminal Block TOPJOB® S; with Mounting Flange

2.5 (4) mm²; 2052 Series

Technical Data

0.25 ... 2.5 (4) mm² ① | 22 ... 12 AWG

800 V/8 kV/3 ②

I_N 24 A (32 A)

Terminal block width: 5.2 mm / 0.205 inch

10 ... 12 mm / 0.39 ... 0.47 inch



4

Dimensions in mm

Modular terminal blocks and terminal strips with mounting flanges
L = (pole no. x 5.2 mm) + 4.3 mm + 6.7 mm

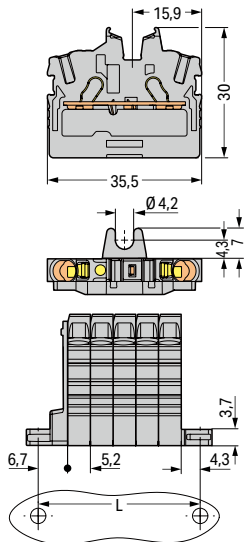

2-conductor miniature through terminal block; with mounting flange; for screw or similar mounting types; 4.2 mm mounting hole diameter; with mounting foot (209-123) also for DIN-35 rail

Color	Item No.	Pack. Unit
gray ☺	2052-301 ④	100
blue ☺	2052-304 ③ ④	100
orange ☺	2052-302 ④	100
red ☺	2052-303 ④	100
black ☺	2052-305 ④	100
yellow ☺	2052-306 ④	100
brown ☺	2052-301/000-014 ④	100
green-yellow ☺	2052-307 ④	100

2-conductor miniature through terminal block; Center terminal block; without snap-in mounting foot; without mounting flange; for 0.6 ... 1.2 mm plate thickness; required between end plate and end terminal block for terminal strips with mounting flanges

gray ☺	2052-321 ④	100
blue ☺	2052-324 ③ ④	100
orange ☺	2052-322 ④	100
red ☺	2052-323 ④	100
black ☺	2052-325 ④	100
yellow ☺	2052-326 ④	100
brown ☺	2052-321/000-014 ④	100
green-yellow ☺	2052-327 ④	100

- Conductor range: 0.25 ... 4 mm² "s+f-st"
Push-in termination: 1 ... 4 mm² "s" and 1 ... 2.5 mm² "insulated ferrules, 12 mm"
Depending on the conductor characteristic, a conductor with a smaller cross-section can also be inserted via push-in termination.
- 800 V = rated voltage
8 kV = rated impulse voltage
3 = pollution degree
(see Section 15)
- Terminal blocks with a blue insulated housing are suitable for Ex i applications.
- Terminal blocks with an Ex mark are suitable for Ex e II applications.
550 V; 22 A
20 A jumper
(see Section 15)

Please observe the application notes:
Jumpers, from page 182
Testing accessories, from page 177
Marking, from page 684

Approvals and corresponding ratings,
visit www.wago.com

Accessories; 2252 Series

Appropriate marking systems:
WMB/WMB Inline/Marking strips

End plate; with mounting flange; 1.3 mm thick

gray	2052-381	100 (25)
------	----------	----------



Insulation stop; 5 pcs/strip; 0.25 ... 0.5 mm²

light gray	2002-171	200 (25)
------------	----------	----------



Insulation stop; 5 pcs/strip; 0.75 ... 1 mm²

dark gray	2002-172	200 (25)
-----------	----------	----------



Push-in type jumper bar; insulated; I_N 25 A; light gray

2-way	2002-402	25
3-way	2002-403	25
4-way	2002-404	25
5-way	2002-405	25
6-way	2002-406	25
7-way	2002-407	25
8-way	2002-408	25
9-way	2002-409	25
10-way	2002-410	25



Push-in type jumper bar; insulated; I_N 25 A; light gray

1 to 3	2002-433	25
1 to 4	2002-434	25
1 to 5	2002-435	25
1 to 6	2002-436	25
1 to 7	2002-437	25
1 to 8	2002-438	25
1 to 9	2002-439	25
1 to 10	2002-440	25



Delta jumper; insulated; I_N = I_N terminal block; light gray

1-2 3-4 5-6	2002-406/020-000	25
-------------	------------------	----



Star point jumper; insulated; I_N = I_N terminal block; light gray

1-3-5	2002-405/011-000	25
-------	------------------	----



Accessories; 2252 Series

Appropriate marking systems:
WMB/WMB Inline/Marking strips

Continuous jumper; insulated; I_N 25 A; light gray

1-2	2002-400	25
-----	----------	----



Continuous jumper; insulated; I_N 25 A; light gray

1 to 3	2002-423	25
--------	----------	----



1 to 4	2002-424	25
--------	----------	----

Continuous jumper; insulated; I_N 25 A; light gray

3-way	2002-413	25
-------	----------	----



5-way	2002-415	25
-------	----------	----

Staggered jumper; insulated; I_N 25 A; light gray

2-way	2002-472	25
-------	----------	----



3-way	2002-473	25
-------	----------	----

4-way	2002-474	25
-------	----------	----

5-way	2002-475	25
-------	----------	----

6-way	2002-476	25
-------	----------	----

7-way	2002-477	25
-------	----------	----

8-way	2002-478	25
-------	----------	----

9-way	2002-479	25
-------	----------	----

10-way	2002-480	25
--------	----------	----

11-way	2002-481	25
--------	----------	----

12-way	2002-482	25
--------	----------	----

Push-in type wire jumper; insulated; 1.5 mm² conductor cross-section; I_N 18 A

L = 60 mm	2009-412	100 (10)
L = 110 mm	2009-414	100 (10)
L = 250 mm	2009-416	100 (10)



Protective warning marker; with black high-voltage symbol; for 5 terminal blocks

yellow	2002-115	100 (25)
--------	----------	----------



L-type test plug module; snaps together

gray	2002-611	100 (25)
------	----------	----------



Marking strip; plain; 11 mm wide; 50 m reel

white	2009-110	1
-------	----------	---



WMB Inline; plain; 1,500 WMB markers (5 mm)/reel; stretchable 5 ... 5.2 mm

white	2009-115	1
-------	----------	---



WMB marker card; white; 10 strips with 10 markers/card; stretchable 5 ... 5.2 mm

plain	793-5501	5
-------	----------	---



Mounting foot with screw; for DIN-35 rail; can be screwed on terminal blocks with mounting flange; 6.4 mm wide

gray	209-123	25
------	---------	----



Mounting adapter; for DIN-35 rail; can be used as an end stop; 6.5 mm wide

gray	209-137	25
------	---------	----



Miniature Through Terminal Block TOPJOB® S; with Snap-In Mounting Foot

2.5 (4) mm²; 2052 Series

Technical Data

0.25 ... 2.5 (4) mm² ① | 22 ... 12 AWG
 800 V/8 kV/3 ②
 I_N 24 A (32 A)
 Terminal block width: 5.2 mm / 0.205 inch
 10 ... 12 mm / 0.39 ... 0.47 inch



Dimensions in mm

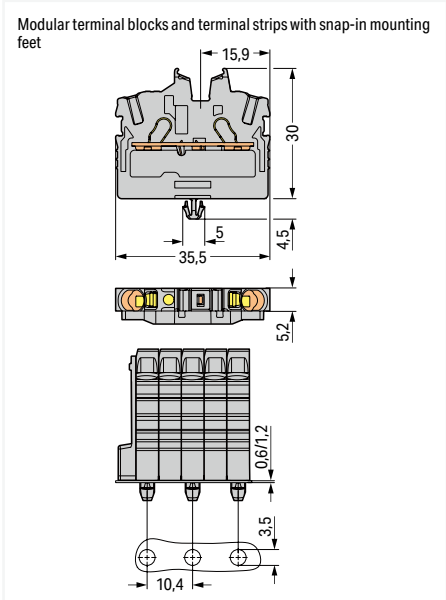

2-conductor miniature through terminal block; with snap-in mounting foot; for 0.6 ... 1.2 mm plate thickness; 3.5 mm mounting hole diameter; also for aluminum DIN-rail (210-154) or with mounting foot (209-120) for DIN-35 rail

Color	Item No.	Pack. Unit
gray ☺	2052-311 ④	100
blue ☺	2052-314 ③ ④	100
orange ☺	2052-312 ④	100
red ☺	2052-313 ④	100
black ☺	2052-315 ④	100
yellow ☺	2052-316 ④	100
brown ☺	2052-311/000-014 ④	100
green-yellow ☺	2052-317 ④	100

2-conductor miniature through terminal block; Center terminal block; without snap-in mounting foot; without mounting flange; for 0.6 ... 1.2 mm plate thickness; required between end plate and end terminal block for terminal strips with mounting flanges

gray ☺	2052-321 ④	100
blue ☺	2052-324 ③ ④	100
orange ☺	2052-322 ④	100
red ☺	2052-323 ④	100
black ☺	2052-325 ④	100
yellow ☺	2052-326 ④	100
brown ☺	2052-321/000-014 ④	100
green-yellow ☺	2052-327 ④	100

- Conductor range: 0.25 ... 4 mm² "s+f-st"
 Push-in termination: 1 ... 4 mm² "s" and 1 ... 2.5 mm² "insulated ferrules, 12 mm"
 Depending on the conductor characteristic, a conductor with a smaller cross-section can also be inserted via push-in termination.
- 800 V = rated voltage
 8 kV = rated impulse voltage
 3 = pollution degree (see Section 15)
- Terminal blocks with a blue insulated housing are suitable for Ex i applications.
- Terminal blocks with an Ex mark are suitable for Ex e II applications.
 550 V; 22 A
 20 A jumper (see Section 15)

Please observe the application notes:
 Jumpers, from page 182
 Testing accessories, from page 177
 Marking, from page 684

Approvals and corresponding ratings, visit www.wago.com

Accessories; 2252 Series

Appropriate marking systems:
 WMB/WMB Inline/Marking strips

End plate; for terminal blocks with snap-in mounting foot; 3.4 mm thick

gray	2052-391	100 (25)
------	----------	----------

Insulation stop; 5 pcs/strip; 0.25 ... 0.5 mm²

light gray	2002-171	200 (25)
------------	----------	----------

Insulation stop; 5 pcs/strip; 0.75 ... 1 mm²

dark gray	2002-172	200 (25)
-----------	----------	----------

Push-in type jumper bar; insulated; I_N 25 A; light gray

2-way	2002-402	25
3-way	2002-403	25
4-way	2002-404	25
5-way	2002-405	25
6-way	2002-406	25
7-way	2002-407	25
8-way	2002-408	25
9-way	2002-409	25
10-way	2002-410	25

Push-in type jumper bar; insulated; I_N 25 A; light gray

1 to 3	2002-433	25
1 to 4	2002-434	25
1 to 5	2002-435	25
1 to 6	2002-436	25
1 to 7	2002-437	25
1 to 8	2002-438	25
1 to 9	2002-439	25
1 to 10	2002-440	25

Delta jumper; insulated; I_N = I_N terminal block; light gray

1-2 3-4 5-6	2002-406/020-000	25
-------------	------------------	----

Star point jumper; insulated; I_N = I_N terminal block; light gray

1-3-5	2002-405/011-000	25
-------	------------------	----

Accessories; 2252 Series

Appropriate marking systems:
 WMB/WMB Inline/Marking strips

Continuous jumper; insulated; I _N 25 A; light gray	1-2	2002-400	25
---	-----	----------	----

Continuous jumper; insulated; I _N 25 A; light gray	1 to 3	2002-423	25
	1 to 4	2002-424	25

Continuous jumper; insulated; I _N 25 A; light gray	3-way	2002-413	25
	5-way	2002-415	25

Staggered jumper; insulated; I_N 25 A; light gray

2-way	2002-472	25
3-way	2002-473	25
4-way	2002-474	25
5-way	2002-475	25
6-way	2002-476	25
7-way	2002-477	25
8-way	2002-478	25
9-way	2002-479	25
10-way	2002-480	25
11-way	2002-481	25
12-way	2002-482	25

Push-in type wire jumper; insulated; 1.5 mm² conductor cross-section; I_N 18 A

L = 60 mm	2009-412	100 (10)
L = 110 mm	2009-414	100 (10)
L = 250 mm	2009-416	100 (10)

Protective warning marker; with black high-voltage symbol; for 5 terminal blocks

yellow	2002-115	100 (25)
--------	----------	----------

L-type test plug module; snaps together

gray	2002-611	100 (25)
------	----------	----------

WMB marker card; white; 10 strips with 10 markers/card; stretchable 5 ... 5.2 mm

plain	793-5501	5
-------	----------	---

Aluminum DIN-rail; 1000 mm long; 18 mm wide; 7 mm high

	210-154	1
--	---------	---

Plastic end stop; with WSB marker slot; for aluminum DIN-rail (210-154); 6 mm wide

	209-122	25
--	---------	----

Mounting foot; for DIN-35 rail; snaps onto terminal blocks with snap-in mounting foot; 6.4 mm wide

gray	209-120	25
------	---------	----





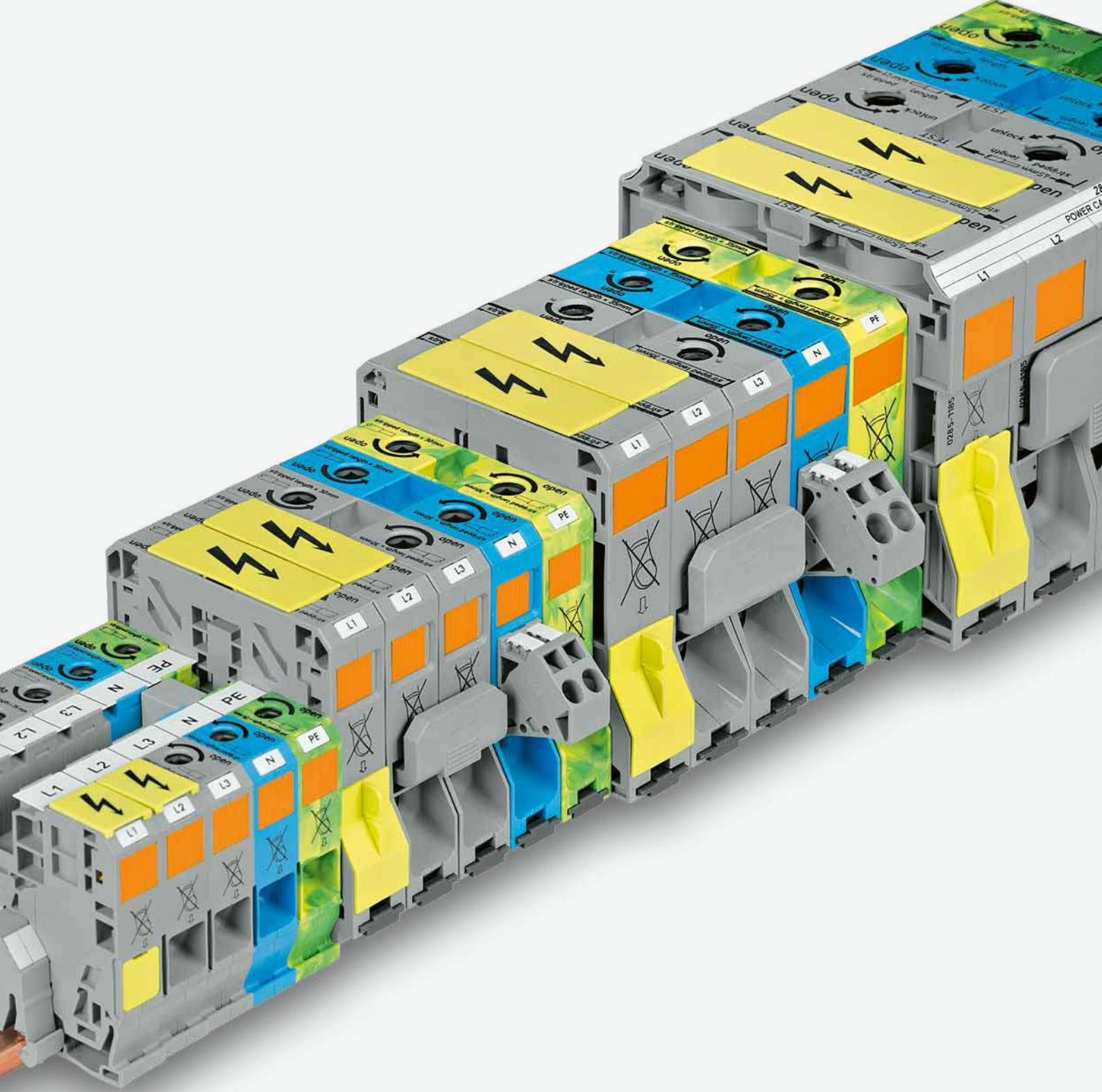

Mounting adapter; for DIN-35 rail; can be used as an end stop; 6.5 mm wide

gray	209-137	25
------	---------	----



WAGO High-Current Rail-Mount Terminal Blocks

WAGO High-Current Rail-Mount Terminal Blocks

			Page
	Through Terminal Blocks and Ground Conductor Terminal Blocks 6 ... 35 mm ² (10 ... 2 AWG)	285 Series	298
	Power Taps; for 35 mm² (2 AWG) Terminal Blocks 0.2 ... 6 mm ² (24 ... 10 AWG)	285 Series	298
	Through Terminal Blocks and Ground Conductor Terminal Blocks 10 ... 50 (70) mm ² (8 ... 1/0 AWG)	285 Series	302
	Power Taps; for 50 mm² (1/0 AWG) Terminal Blocks 0.2 ... 6 mm ² (24 ... 10 AWG)	285 Series	302
	Through Terminal Blocks; with Mounting Flanges 10 ... 50 (70) mm ² (8 ... 1/0 AWG)	285 Series	303
	Through Terminal Blocks and Ground Conductor Terminal Blocks 25 ... 95 mm ² (4 ... 4/0 AWG)	285 Series	304
	Power Taps; for 95 mm² (4/0 AWG) Terminal Blocks 0.2 ... 10 (16) mm ² (24 ... 8 AWG)	285 Series	304
	Through Terminal Blocks; with Mounting Flanges 25 ... 95 mm ² (4 ... 4/0 AWG)	285 Series	305
	Through Terminal Blocks and Ground Conductor Terminal Blocks 50 ... 185 mm ² (1/0 AWG ... 350 kcmil)	285 Series	306
	Power Taps; for 185 mm² (350 kcmil) Terminal Blocks 0.2 ... 10 (16) mm ² (24 ... 8 AWG)	285 Series	306
	Through Terminal Blocks; with Mounting Flanges 50 ... 185 mm ² (1/0 AWG ... 350 kcmil)	285 Series	307

High-Current Rail-Mount Terminal Blocks; 35 mm² 285 Series Description and Installation

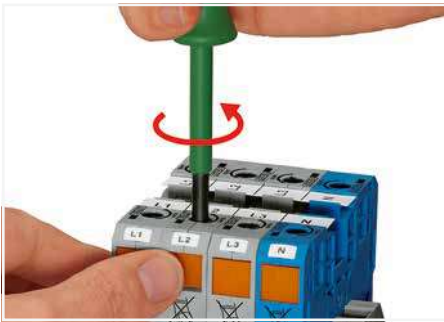

Conductor termination – step 1:
Rotate the operating tool (5.5 mm blade width) counter-clockwise. Next, push in the orange locking tab. The clamp is locked open for hands-free wiring.

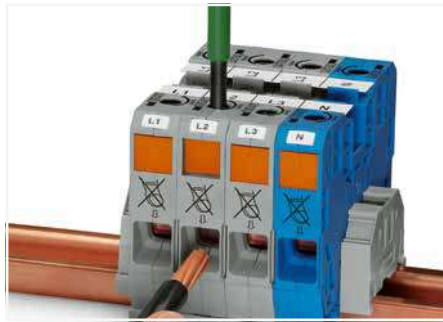

Conductor termination – step 2:
Insert a stripped conductor into the clamping unit until it hits backstop. Hold in this position.

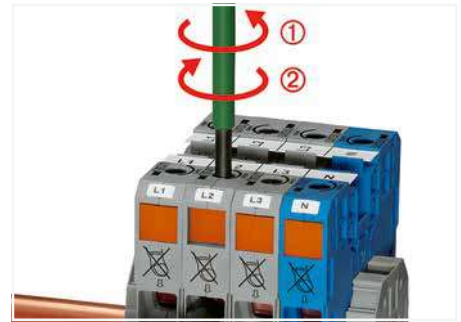

Conductor termination – step 3:
A short counter-clockwise rotation closes the clamp, securing the conductor ①. When unlocked, allow operating tool to rotate clockwise ② to securely terminate the conductor.

5



The power tap is inserted into the jumper contact slot. It can be fitted with a strain relief plate.



Testing
Voltage measurements can be performed (e.g., via 2-pole 206-707 Voltage Tester).



Testing with test plug adapter (283-404).



High-current rail-mount terminal blocks, 35 mm² (2 AWG) and 50 mm² (2/0 AWG)



POWER CAGE CLAMP
terminates the following
copper conductors:
solid "s"



stranded "st"



fine-stranded,
also with tinned
single strands

POWER CAGE CLAMP®



Commoning adjacent terminal blocks using a centrally positioned push-in jumper.



Slide the marking strip laterally to remove the jumper.



Commoning 35 mm² (2 AWG) POWER CAGE CLAMP Terminal Blocks with 10/16 mm² (8/6 AWG) 2010 and 2016 Series Terminal Blocks TOPJOB® S using step-down jumpers (not valid for 2016-76xx and 2016-77xx).



Step-down jumpers common terminal blocks of different sizes, without losing a conductor clamping point. This can be beneficial on long conductor runs where voltage drop can be a problem. A large conductor can be easily connected to smaller conductors at the distribution point.

Step-down jumpers are simply pushed down for full insertion, similar to adjacent jumpers. Commoning may be made in either direction using the special thin end plate to cover the open side. Additional through terminal blocks having a smaller cross-section may be commoned using adjacent jumpers.

In this case, pay attention that:
The total current of the outgoing circuits does not exceed the nominal current of the step-down jumper.

5



Side-entry wiring means that even larger conductors, which have limited flexibility, can be easily connected.



WMB markers or self-adhesive, printable marking strips can be accommodated on 35, 50 and 95 mm² high-current terminal blocks.



Marker carrier (285-442) for marking strip (2009-110) or 2 x WMB markers



fine-stranded, with ferrule (gastight crimped)



High-Current Through Terminal Block, High-Current Ground Conductor Terminal Block 35 mm²; 285 Series

Technical Data

6 ... 35 mm ²	8 ... 2 AWG
1000 V / 8 kV / 3 ①	600 V, 115 A ②
I _N 125 A	600 V, 115 A ③
Terminal block width: 16 mm / 0.63 inch	
25 mm / 0.98 inch	

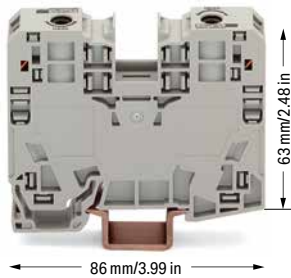

Technical Data

0.2 ... 6 mm ²	24 ... 10 AWG
800 V / 8 kV / 3 ②	600 V, 30 A ③
I _N 32 A	600 V, 32 A ③
Module width: 8 mm / 0.315 inch	
12 ... 13 mm / 0.47 ... 0.51 inch	



- ① 1000 V = rated voltage
8 kV = rated impulse voltage
3 = pollution degree
(see Section 15)
- ② 800 V = rated voltage
8 kV = rated impulse voltage
3 = pollution degree
(see Section 15)
- ③ Terminal blocks with an Ex mark are suitable for Ex e II applications.
880 V, 101 A
1 jumper, 85 A
4 ... 5 jumpers, 75 A
(see Section 15)

Please observe the application notes:
Step-down jumpers, see page 297
Marking, from page 684

Approvals and corresponding ratings,
visit www.wago.com

5

2-conductor through terminal block; only for DIN 35 x 15 rail

Color	Item No.	Pack. Unit
gray	285-135	15
blue	285-134	15
light gray ③	285-935 ③	15
dark gray/yellow	285-131	15

2-conductor ground terminal block; only suitable for DIN 35 x 15 rail; 2.3 mm thick; copper

green-yellow	285-137	15
green-yellow ③	285-137/999-950 ③	15

Accessories; item-specific

Adjacent jumper; insulated; I_N 85 A

gray	285-435	50 (25)
------	---------	---------

Step-down jumper; insulated; I_N 90 A

gray	285-430	50 (25)
------	---------	---------

Protective warning marker; with a black high-voltage symbol

yellow	285-420	100 (25)
--------	---------	----------

Finger guard; touch-proof cover protects unused conductor entries

yellow	285-421	100 (25)
--------	---------	----------

Test plug adapter; 11.6 mm wide; for 4 mm Ø test plug; for 1.5 ... 16 mm² terminal blocks

gray	283-404	25
------	---------	----

Three-phase set; with 35 mm² high-current terminal blocks

three-phase set	285-139	1
-----------------	---------	---

Power tap; I_N 24 A; with 500 mm cable; for 16 mm² (283/783 Series) and 35 mm² (285/785 Series) rail-mount terminal blocks

gray	283-407	25
------	---------	----

Operating tool with a partially insulated shaft; type 3; (5.5 x 0.8) mm blade

operating tool	210-721	25 (1)
----------------	---------	--------

Power tap; for 35 mm² high-current terminal blocks

Color	Item No.	Pack. Unit
gray	285-427	5

Accessories; item-specific

Strain relief plate; gray

1-pole	769-410	100 (25)
--------	---------	----------

Test plug; with 500 mm cable; 2 mm Ø; max. 42 V

red	210-136	50 (1)
-----	---------	--------

WMB marking card; white; 10 strips with 10 markers/card; for 5 ... 17.5 mm terminal block width

plain	793-501	5
-------	---------	---

WMB marking card; white; 10 strips with 10 markers/card; 5 ... 5.2 mm stretchable

plain	793-5501	5
-------	----------	---

Accessories; for high-current terminal blocks

Appropriate marking systems:
WMB/WMB Inline/Marking strips

Copper DIN-rail; per EN 60715; 35 x 15 mm; 2.3 mm thick; 2 m long

unslotted	210-198	10
-----------	---------	----

Marking strip; plain; 11 mm wide; 50 m reel

white	2009-110	1
-------	----------	---

WMB marking card; white; 10 strips with 10 markers/card; for 5 ... 17.5 mm terminal block width

plain	793-501	5
-------	---------	---

WMB marking card; white; 10 strips with 10 markers/card; 5 ... 5.2 mm stretchable

plain	793-5501	5
-------	----------	---

Marker carrier; for POWER CAGE CLAMP 35/50/95 mm²; 10.4 mm wide

gray	285-442	25
------	---------	----

Screwless end stop; for DIN-35 rail; 14 mm wide

gray	249-197	10
------	---------	----

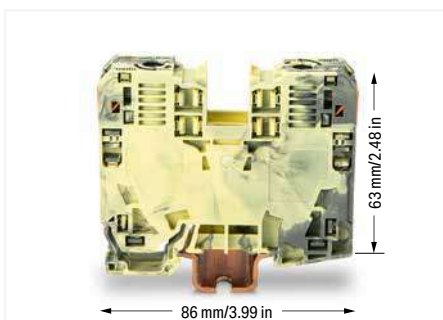

2-conductor through terminal block, dark gray/yellow (285-131), for ground connection without contact to the DIN-rail



Always push voltage tap (283-407) down into the terminal block until fully inserted!

5

High-Current Rail-Mount Terminal Blocks; 50 ... 185 mm² 285 Series Description and Installation



Conductor termination – step 1:
Rotate the T-wrench counter-clockwise to the stop ①. Next, push in the orange locking tab. The clamp is locked open for hands-free wiring.

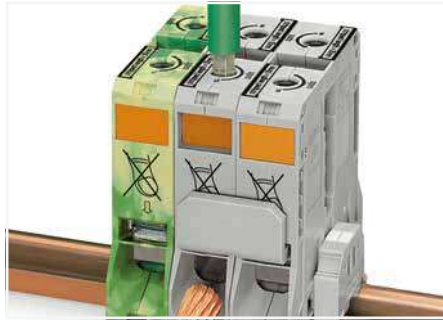

Conductor termination – step 2:
Insert a stripped conductor into the clamping unit until it hits backstop. Hold in this position.



Conductor termination – step 3:
A short counter-clockwise rotation ② releases the tab. When unlocked, the T-wrench rotates clockwise, securely clamping the conductor.

5



For the optimal clamping force:

- Bend conductor.
- Cut conductor to length (conductor end must be straight).
- Stripping a conductor.



Always observe the printed strip length!



Grounding foot:
Ground conductor terminal blocks (limited to max. 120 mm²/250 kcmil per EN 60947-7-2) must be snapped onto a 2.3 mm thick copper DIN-rail.



Protective warning marker may indicate:
Notice: Power is still on even after switching off the main switch!



Risk of injury!
Do not insert fingers in the conductor entry!



Yellow, detachable finger guards provide touch-proof safety by shielding jumper contact slots and/or unused conductor entries.



POWER CAGE CLAMP
terminates the following
copper conductors:
solid "s"



stranded "st"



fine-stranded "f-st",
also with tinned
single strands



Commoning with an adjacent jumper: insert the jumper above the conductor entry hole – prior to conductor termination. The nominal cross-section remains unchanged.

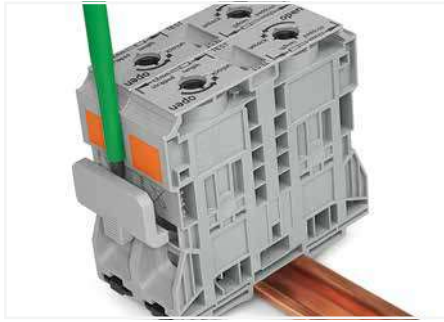

Removing jumper via operating tool.

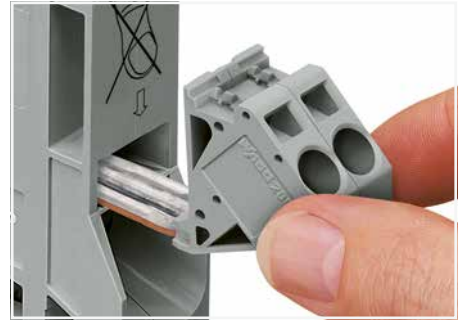

Reliably and easily tap directly into the power supply. Insert the unwired tap before opening the clamping unit.

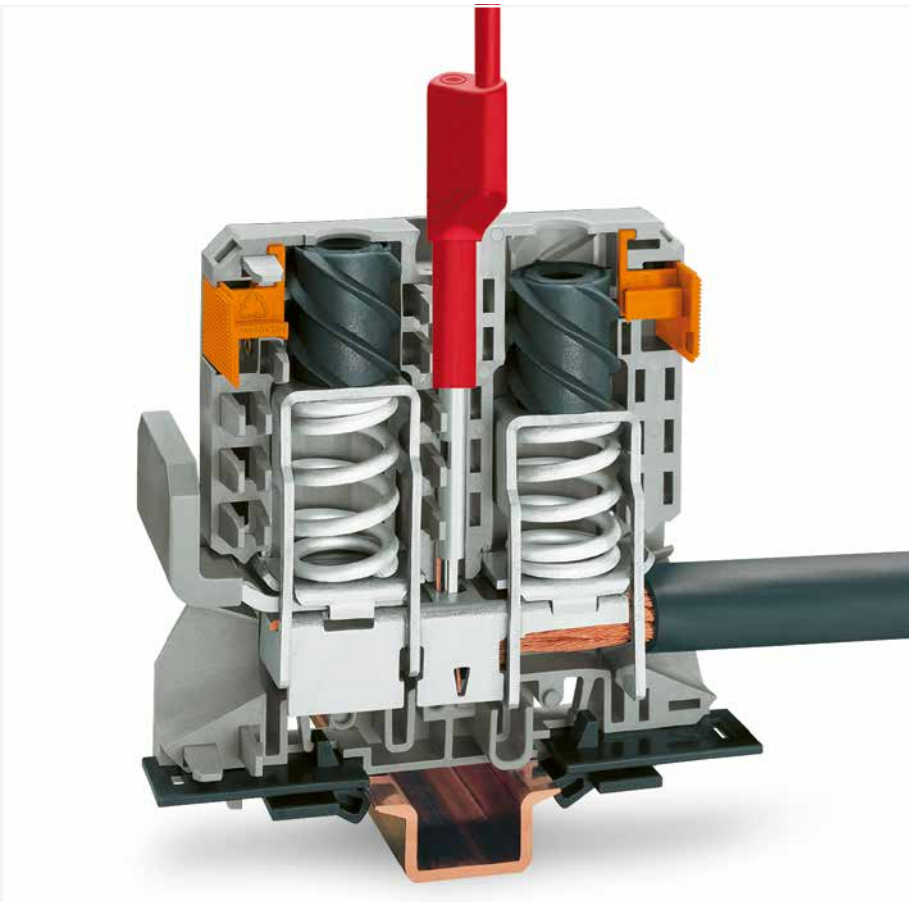

Testing via touch-proof 4 mm Ø test plugs (not available from WAGO, but offered by industry suppliers such as, Multi-Contact Deutschland GmbH).



Testing
Voltage measurements can be performed (e.g., via 2-pole 206-707 Voltage Tester).



WMB markers or self-adhesive, printable marking strips can be accommodated on 35, 50 and 95 mm² high-current terminal blocks.



In addition to WMB markers, marking strips can be directly applied to 185 mm² (350 kcmil) high-current terminal blocks.



fine-stranded, with ferrule (gastight crimped)



High-Current Through Terminal Block, High-Current Ground Conductor Terminal Block

50 (70 "f-st") mm²; 285 Series

Technical Data

10 ... 50 (70 "f-st") mm ²	8 ... 1/0 AWG
1000 V / 8 kV / 3 ①	600 V, 150 A [Ⓐ]
I _N 150 A	600 V, 150 A [Ⓒ]
Terminal block width: 20 mm / 0.787 inch	
30 mm / 1.18 inch	

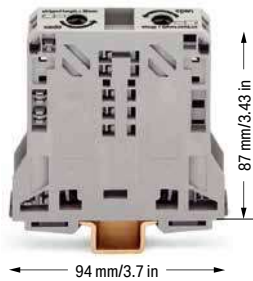

Technical Data

0.2 ... 6 mm ²	24 ... 10 AWG
1000 V / 8 kV / 3 ①	600 V, 30 A [Ⓐ]
I _N 41 A	600 V, 41 A [Ⓒ]
Module width: 16 mm / 0.63 inch	
12 ... 13 mm / 0.47 ... 0.51 inch	



- ① 1000 V = rated voltage
8 kV = rated impulse voltage
3 = pollution degree
(see Section 15)
- ② Terminal blocks with an Ex mark are suitable for Ex e II applications.
880 V, 134 A
(see Section 15)

Adjacent jumpers (285-450) can only be removed or inserted when the clamp is closed.

Please observe the application notes: Marking, from page 684

Approvals and corresponding ratings, visit www.wago.com

Accessories; for high-current terminal blocks

Appropriate marking systems:
WMB/WMB Inline/Marking strips

Marking strip; plain; 11 mm wide; 50 m reel

white	2009-110	1
-------	----------	---

WMB marking card; white; 10 strips with 10 markers/card; for 5 ... 17.5 mm terminal block width

plain	793-501	5
-------	---------	---

WMB marking card; white; 10 strips with 10 markers/card; 5 ... 5.2 mm stretchable

plain	793-5501	5
-------	----------	---

Marker carrier; for POWER CAGE CLAMP 35/50/95 mm²; 10.4 mm wide

gray	285-442	25
------	---------	----

5

2-conductor through terminal block; only for DIN 35 x 15 rail

Color	Item No.	Pack. Unit
gray	285-150	5
blue	285-154	5
light gray ②	285-950	5
dark gray/yellow	285-151	5

2-conductor ground terminal block; only suitable for DIN 35 x 15 rail; 2.3 mm thick; copper

green-yellow	285-157	5
green-yellow ②	285-157/999-950	5

Accessories; item-specific

Adjacent jumper; insulated; I_N 150 A, for 1 jumper; I_N 130 A, for 2 ... 4 jumpers

gray	285-450	100 (25)
------	---------	----------

Protective warning marker; with a black high-voltage symbol

yellow	285-440	50 (25)
--------	---------	---------

Protective warning marker; with a black high-voltage symbol

yellow	285-449	25
--------	---------	----

Finger guard; touch-proof cover protects unused conductor entries and jumper slots

yellow	285-441	100 (25)
--------	---------	----------

Three-phase set; with 50 mm² high-current terminal blocks

	285-159	1
--	---------	---

Copper DIN-rail; per EN 60715; 35 x 15 mm; 2.3 mm thick; 2 m long

unslotted	210-198	10
-----------	---------	----

Screwless end stop; for DIN-35 rail; 14 mm wide

gray	249-197	10
------	---------	----

T-wrench with a partially insulated shaft

	285-172	1
--	---------	---

Power tap; for 50 mm² high-current terminal blocks

Color	Item No.	Pack. Unit
gray	285-447	5

Accessories; item-specific

Protective warning marker; with black high-voltage symbol; for 5 terminal blocks

yellow	282-415	50 (25)
--------	---------	---------

WMB marking card; white; 10 strips with 10 markers/card; for 5 ... 17.5 mm terminal block width

plain	793-501	5
-------	---------	---

WMB marking card; white; 10 strips with 10 markers/card; 5 ... 5.2 mm stretchable

plain	793-5501	5
-------	----------	---

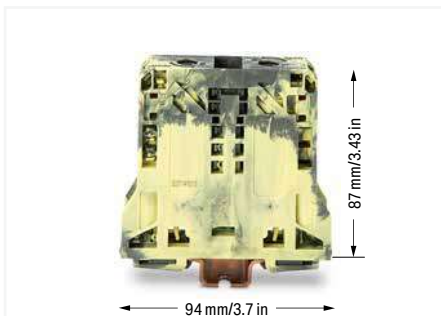

2-conductor through terminal block, dark gray/yellow (285-151), for ground connection without contact to the DIN-rail



Marker carrier (285-442) for marking strip (2009-110) or 2 x WMB markers

High-Current Through Terminal Block; with Mounting Flanges

50 (70 "f-st") mm²; 285 Series

Technical Data	
10 ... 50 (70 "f-st") mm ²	8 ... 1/0 AWG
1000 V / 8 kV / 3 ①	600 V, 150 A VA
I _N 150 A	600 V, 150 A Ⓔ
Terminal block width: 20 mm / 0.787 inch	
 30 mm / 1.18 inch	

Technical Data	
10 ... 50 (70 "f-st") mm ²	8 ... 1/0 AWG
1000 V / 8 kV / 3 ①	600 V, 150 A VA
I _N 150 A	600 V, 150 A Ⓔ
Terminal block width: 20 mm / 0.787 inch	
 30 mm / 1.18 inch	

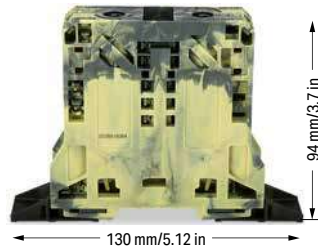

2-conductor through terminal block; with mounting flanges		
Color	Item No.	Pack. Unit
○ gray	285-141	5
● blue	285-144	5
○ light gray Ⓔ	285-143 ②	5

2-conductor through terminal block; with mounting flanges		
Color	Item No.	Pack. Unit
● dark gray/yellow	285-147	5
● dark gray/yellow Ⓔ	285-147/999-950 ②	5

Accessories; for high-current terminal blocks

Appropriate marking systems: WMB/WMB Inline/Marking strips

Adjacent jumper; insulated; I _N 150 A, for 1 jumper; I _N 130 A, for 2 ... 4 jumpers		
Color	Item No.	Pack. Unit
gray	285-450	100 (25)



Marking strip; plain; 11 mm wide; 50 m reel		
Color	Item No.	Pack. Unit
white	2009-110	1



Block-to-block connector; for 50 mm ² high-current terminal blocks		
Color	Item No.	Pack. Unit
orange	285-448	50 (25)



WMB marking card; white; 10 strips with 10 markers/card; for 5 ... 17.5 mm terminal block width		
Color	Item No.	Pack. Unit
plain	793-501	5



Protective warning marker; with a black high-voltage symbol		
Color	Item No.	Pack. Unit
yellow	285-440	50 (25)



WMB marking card; white; 10 strips with 10 markers/card; 5 ... 5.2 mm stretchable		
Color	Item No.	Pack. Unit
plain	793-5501	5



Protective warning marker; with a black high-voltage symbol		
Color	Item No.	Pack. Unit
yellow	285-449	25



Marker carrier; for POWER CAGE CLAMP 35/50/95 mm ² ; 10.4 mm wide		
Color	Item No.	Pack. Unit
gray	285-442	25



Finger guard; touch-proof cover protects unused conductor entries and jumper slots		
Color	Item No.	Pack. Unit
yellow	285-441	100 (25)



Three-phase set; with 50 mm ² high-current terminal blocks		
Item No.	Pack. Unit	
285-148	1	



Power tap; for 50 mm ² high-current terminal blocks		
Color	Item No.	Pack. Unit
gray	285-447	5



T-wrench with a partially insulated shaft		
Item No.	Pack. Unit	
285-172	1	



- 1000 V = rated voltage
8 kV = rated impulse voltage
3 = pollution degree
(see Section 15)
- Terminal blocks with an Ex mark are suitable for Ex e II applications.
880 V, 134 A
(see Section 15)

Adjacent jumpers (285-450) can only be removed or inserted when the clamp is closed.

Please observe the application notes: Marking, from page 684

Approvals and corresponding ratings, visit www.wago.com



Optionally, insert block-to-block connector (285-448) into housing slot.



Align and snap high-current, through terminal blocks together.

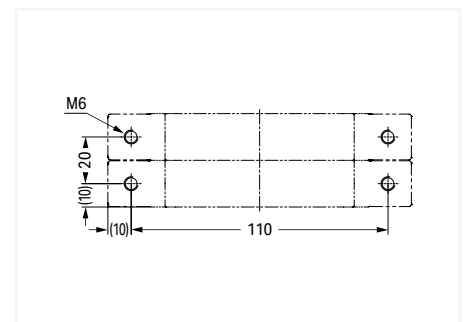

Dimensions (in mm):
Drill hole separation distance



High-Current Through Terminal Block, High-Current Ground Conductor Terminal Block 95 mm²; 285 Series

Technical Data

25 ... 95 mm ²	4 ... 4/0 AWG
1000 VAC/DC/1500 VDC/12 kV / 3	2 600 V, 200 A
I _N 232 A	1000 V, 210 A
Terminal block width: 25 mm / 0.984 inch	
35 mm / 1.38 inch	

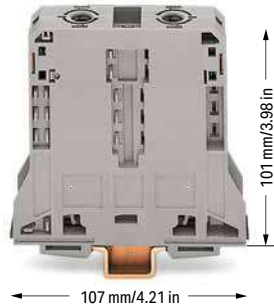

Technical Data

0.2 ... 10 (16) mm ² 1	24 ... 8 AWG
1000 V / 8 kV / 3 2	600 V, 50 A
I _N 57 A	600 V, 57 A
Module width: 20 mm / 0.787 inch	
12 ... 13 mm / 0.47 ... 0.51 inch	



- 1 Power tap; for 95 mm² high-current terminal blocks
Max. conductor size: 16 mm²
- 2 1000 VAC/DC
1500 VDC = rated voltage
12 kV = rated impulse voltage
3 = pollution degree
(see Section 15)
- 3 1000 V = rated voltage
8 kV = rated impulse voltage
3 = pollution degree
- 4 Terminal blocks with an Ex mark are suitable for Ex e II applications.
25 ... 95 mm² / 4 ... 4/0 AWG
880 V, 211 A
1 jumper, 211 A
2 ... 4 jumpers, 175 A
35 ... 70 mm² / 2 ... 2/0 AWG
for ground conductor terminal blocks
(see Section 15)

Please observe the application notes:
Marking, from page 684

Approvals and corresponding ratings,
visit www.wago.com

Accessories; for high-current terminal blocks

Appropriate marking systems:
WMB/WMB Inline/Marking strips

Marking strip; plain; 11 mm wide; 50 m reel

white	2009-110	1
-------	----------	---

WMB marking card; white; 10 strips with 10 markers/card; for 5 ... 17.5 mm terminal block width

plain	793-501	5
-------	---------	---

WMB marking card; white; 10 strips with 10 markers/card; 5 ... 5.2 mm stretchable

plain	793-5501	5
-------	----------	---

Marker carrier; for POWER CAGE CLAMP 35/50/95 mm²; 10.4 mm wide

gray	285-442	25
------	---------	----



Marker carrier (285-442) for marking strip (2009-110) or 2 x WMB markers

5

2-conductor through terminal block; only for DIN 35 x 15 rail

Color	Item No.	Pack. Unit
gray	285-195	5
blue	285-194	5
light gray	285-995 1	5
dark gray/yellow	285-191	5

2-conductor ground terminal block; only suitable for DIN 35 x 15 rail; 2.3 mm thick; copper

green-yellow	285-197	5
green-yellow	285-197/999-950 1	5

Accessories; item-specific

Adjacent jumper; insulated; I_N 232 A, for 1 jumper; I_N 192 A, for 2 ... 4 jumpers

gray	285-495	25
------	---------	----

Protective warning marker; with a black high-voltage symbol

yellow	285-170	50 (25)
--------	---------	---------

Protective warning marker; with a black high-voltage symbol

yellow	285-175	25
--------	---------	----

Finger guard; touch-proof cover protects unused conductor entries and jumper slots

yellow	285-169	25
--------	---------	----

Three-phase set; with 95 mm² high-current terminal blocks

	285-199	1
--	---------	---

Copper DIN-rail; per EN 60715; 35 x 15 mm; 2.3 mm thick; 2 m long

unslotted	210-198	10
-----------	---------	----

Screwless end stop; for DIN-35 rail; 14 mm wide

gray	249-197	10
------	---------	----

T-wrench with a partially insulated shaft

	285-172	1
--	---------	---

Power tap; for 95 mm² high-current terminal blocks

Color	Item No.	Pack. Unit
gray	285-407	5

Accessories; item-specific

Protective warning marker; with black high-voltage symbol; for 5 terminal blocks

yellow	284-415	50 (25)
--------	---------	---------

WMB marking card; white; 10 strips with 10 markers/card; for 5 ... 17.5 mm terminal block width

plain	793-501	5
-------	---------	---

WMB marking card; white; 10 strips with 10 markers/card; 5 ... 5.2 mm stretchable

plain	793-5501	5
-------	----------	---

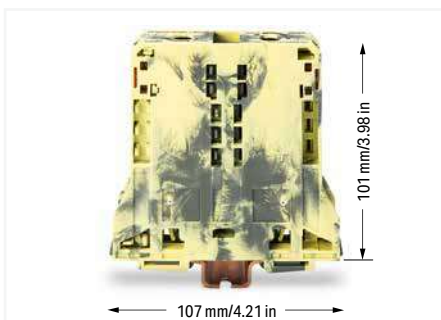

2-conductor through terminal block, dark gray/yellow (285-191), for ground connection without contact to the DIN-rail

High-Current Through Terminal Block; with Mounting Flanges

95 mm²; 285 Series

Technical Data	
25 ... 95 mm ²	4 ... 4/0 AWG
1000 V / 8 kV / 3 ①	600 V, 200 A VA
I _N 232 A	1000 V, 210 A CE
Terminal block width: 25 mm / 0.984 inch	
 35 mm / 1.38 inch	

Technical Data	
25 ... 95 mm ²	4 ... 4/0 AWG
1000 V / 8 kV / 3 ①	600 V, 200 A VA
I _N 232 A	1000 V, 210 A CE
Terminal block width: 25 mm / 0.984 inch	
 35 mm / 1.38 inch	

- ① 1000 V = rated voltage
8 kV = rated impulse voltage
3 = pollution degree
(see Section 15)
- Please observe the application notes:
Marking, from page 684
- Approvals and corresponding ratings,
visit www.wago.com

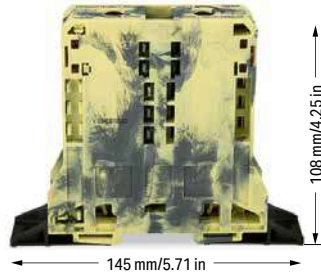

2-conductor through terminal block; with mounting flanges		
Color	Item No.	Pack. Unit
gray	285-181	5
blue	285-184	5

2-conductor through terminal block; with mounting flanges		
Color	Item No.	Pack. Unit
dark gray/yellow	285-187	5

Accessories; for high-current terminal blocks
Appropriate marking systems: WMB/WMB Inline/Marking strips

Adjacent jumper; insulated; I _N 232 A, for 1 jumper; I _N 192 A, for 2 ... 4 jumpers		
Color	Item No.	Pack. Unit
gray	285-495	25

Marking strip; plain; 11 mm wide; 50 m reel		
Color	Item No.	Pack. Unit
white	2009-110	1

Block-to-block connector; for 95 mm ² high-current terminal blocks		
Color	Item No.	Pack. Unit
orange	285-168	50 (25)

WMB marking card; white; 10 strips with 10 markers/card; for 5 ... 17.5 mm terminal block width		
Color	Item No.	Pack. Unit
plain	793-501	5

Protective warning marker; with a black high-voltage symbol		
Color	Item No.	Pack. Unit
yellow	285-170	25

WMB marking card; white; 10 strips with 10 markers/card; 5 ... 5.2 mm stretchable		
Color	Item No.	Pack. Unit
plain	793-5501	5

Protective warning marker; with a black high-voltage symbol		
Color	Item No.	Pack. Unit
yellow	285-175	25

Marker carrier; for POWER CAGE CLAMP 35/50/95 mm ² ; 10.4 mm wide		
Color	Item No.	Pack. Unit
gray	285-442	25

Finger guard; touch-proof cover protects unused conductor entries and jumper slots		
Color	Item No.	Pack. Unit
yellow	285-169	25

Three-phase set; with 95 mm ² high-current terminal blocks		
Item No.	Pack. Unit	
285-188	1	

Power tap; for 95 mm ² high-current terminal blocks		
Item No.	Pack. Unit	
285-407	5	

T-wrench with a partially insulated shaft		
Item No.	Pack. Unit	
285-172	1	



Optionally, insert block-to-block connector (285-168) into housing slot.



Align and snap high-current, through terminal blocks together.

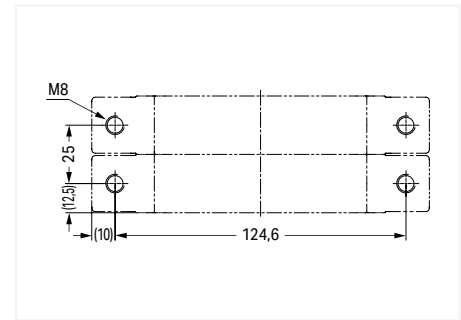

Dimensions (in mm):
Drill hole separation distance



High-Current Through Terminal Block, High-Current Ground Conductor Terminal Block 185 mm²; 285 Series

Technical Data

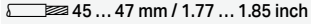
50 ... 185 mm² ① | 1/0 AWG ... 350 kcmil
 1000 VAC/DC/1500 VDC/12 kV / 3 ③ 600 V, 310 A[Ⓜ]
 I_N 353 A | 1000 V, 310 A[Ⓢ]
 Terminal block width: 32 mm / 1.26 inch

Technical Data

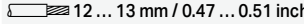
0.2 ... 10 (16) mm² ② | 24 ... 8 AWG
 1000 V / 8 kV / 3 ④ | 600 V, 50 A[Ⓜ]
 I_N 57 A | 600 V, 50 A[Ⓢ]
 Module width: 20 mm / 0.787 inch

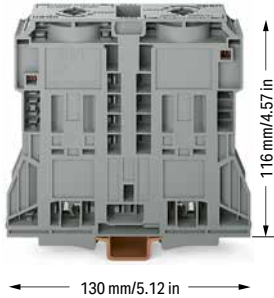

- ① 50 ... 120 mm² / 1/0 AWG ... 250 kcmil for ground conductor terminal blocks (285-1187)
- ② Power tap; for 185 mm² high-current terminal blocks. Max. conductor size: 16 mm²
- ③ 1000 VAC/DC
1500 VDC = rated voltage
12 kV = rated impulse voltage
3 = pollution degree (see Section 15)
- ④ 1000 V = rated voltage
8 kV = rated impulse voltage
3 = pollution degree (see Section 15)
- ⑤ Terminal blocks with an Ex mark are suitable for Ex e II applications.
50 ... 185 mm² / 1/0 AWG ... 350 kcmil
1000 V, 250 A
1 jumper, 250 A
4 ... 5 jumpers, 236 A
50 ... 120 mm² / 1/0 AWG ... 250 kcmil for ground conductor terminal blocks (see Section 15)

Please observe the application notes:
Marking, from page 684

Approvals and corresponding ratings, visit www.wago.com

Accessories; for high-current terminal blocks

Appropriate marking systems:
WMB/WMB Inline/Marking strips

Marking strip; plain; 11 mm wide; 50 m reel

white	2009-110	1
-------	----------	---

WMB marking card; white; 10 strips with 10 markers/card; for 5 ... 17.5 mm terminal block width

plain	793-501	5
-------	---------	---

WMB marking card; white; 10 strips with 10 markers/card; 5 ... 5.2 mm stretchable

plain	793-5501	5
-------	----------	---

Marker carrier; for POWER CAGE CLAMP 35/50/95 mm²; 10.4 mm wide

gray	285-442	25
------	---------	----

5

2-conductor through terminal block; only for DIN 35 x 15 rail

Color	Item No.	Pack. Unit
gray	285-1185	5
blue	285-1184	5
light gray ⑤	285-1189 ⑤	5
dark gray/yellow	285-1181	5

2-conductor ground terminal block; only suitable for DIN 35 x 15 rail; 2.3 mm thick; copper

green-yellow	285-1187	5
green-yellow ⑤	285-1187/999-950 ⑤	5

Accessories; item-specific

Adjacent jumper; insulated; I_N 309 A for 1 jumper

gray	285-1171	25
------	----------	----

Protective warning marker; with a black high-voltage symbol

yellow	285-1177	50 (25)
--------	----------	---------

Protective warning marker; with a black high-voltage symbol

yellow	285-1176	25
--------	----------	----

Finger guard; touch-proof cover protects unused conductor entries and jumper slots

yellow	285-1178	25
--------	----------	----

Three-phase set; with 185 mm² high-current terminal blocks

	285-1169	1
--	----------	---

Copper DIN-rail; per EN 60715; 35 x 15 mm; 2.3 mm thick; 2 m long

unslotted	210-198	10
-----------	---------	----

Screwless end stop; for DIN-35 rail; 14 mm wide

gray	249-197	10
------	---------	----

T-wrench with a partially insulated shaft

	285-172	1
--	---------	---

Power tap; for 185 mm² high-current terminal blocks

Color	Item No.	Pack. Unit
gray	285-1175	5

Accessories; item-specific

Protective warning marker; with black high-voltage symbol; for 5 terminal blocks

yellow	284-415	50 (25)
--------	---------	---------

WMB marking card; white; 10 strips with 10 markers/card; for 5 ... 17.5 mm terminal block width

plain	793-501	5
-------	---------	---

WMB marking card; white; 10 strips with 10 markers/card; 5 ... 5.2 mm stretchable

plain	793-5501	5
-------	----------	---



Tapping directly into the power supply.



In addition to WMB markers, marking strips can be directly applied to 185 mm² (350 kcmil) high-current terminal blocks.



High-Current Through Terminal Block; with Mounting Flanges 185 mm²; 285 Series

Technical Data	
50 ... 185 mm ²	1/0 AWG ... 350 kcmil
1000 VAC/DC/1500 VDC/12 kV / 3 Ⓢ 600 V, 310 A VA	
I _N 353 A	1000 V, 310 A Ⓢ
Terminal block width: 32 mm / 1.26 inch	
45 ... 47 mm / 1.77 ... 1.85 inch	

Technical Data	
50 ... 185 mm ²	1/0 AWG ... 350 kcmil
1000 VAC/DC/1500 VDC/12 kV / 3 Ⓢ 600 V, 310 A VA	
I _N 353 A	1000 V, 310 A Ⓢ
Terminal block width: 32 mm / 1.26 inch	
45 ... 47 mm / 1.77 ... 1.85 inch	

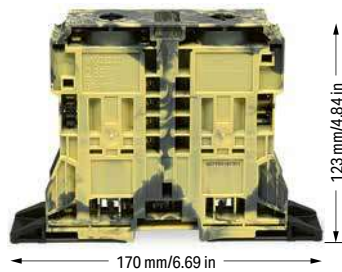

2-conductor through terminal block; with mounting flanges		
Color	Item No.	Pack. Unit
○ gray	285-1161	4
● blue	285-1164	4
○ light gray Ⓢ	285-1163 ②	4

2-conductor through terminal block; with mounting flanges		
Color	Item No.	Pack. Unit
● dark gray/yellow	285-1167	4
● dark gray/yellow Ⓢ	285-1167/999-950 ②	4

Accessories; for high-current terminal blocks
Appropriate marking systems: WMB/WMB Inline/Marking strips

Adjacent jumper; insulated; I _N 309 A for 1 jumper			
Color	Item No.	Pack. Unit	Image
gray	285-1171	25	

Marking strip; plain; 11 mm wide; 50 m reel			
Color	Item No.	Pack. Unit	Image
white	2009-110	1	

Block-to-block connector; for 185 mm ² high-current terminal blocks			
Color	Item No.	Pack. Unit	Image
orange	285-1179	50 (25)	

WMB marking card; white; 10 strips with 10 markers/card; for 5 ... 17.5 mm terminal block width			
Color	Item No.	Pack. Unit	Image
plain	793-501	5	

Protective warning marker; with a black high-voltage symbol			
Color	Item No.	Pack. Unit	Image
yellow	285-1177	50 (25)	

WMB marking card; white; 10 strips with 10 markers/card; 5 ... 5.2 mm stretchable			
Color	Item No.	Pack. Unit	Image
plain	793-5501	5	

Protective warning marker; with a black high-voltage symbol			
Color	Item No.	Pack. Unit	Image
yellow	285-1176	25	

Finger guard; touch-proof cover protects unused conductor entries and jumper slots			
Color	Item No.	Pack. Unit	Image
yellow	285-1178	25	

Three-phase set; with 185 mm ² high-current terminal blocks			
Item No.	Pack. Unit	Image	Image
285-1165	1		

Power tap; for 185 mm ² high-current terminal blocks			
Item No.	Pack. Unit	Image	Image
285-1175	5		

T-wrench with a partially insulated shaft			
Item No.	Pack. Unit	Image	Image
285-172	1		

- 1000 VAC/DC
1500 VDC = rated voltage
12 kV = rated impulse voltage
3 = pollution degree
(see Section 15)

- Terminal blocks with an Ex mark are suitable for Ex e II applications.
50 ... 185 mm² / 1/0 AWG ... 350 kcmil
1000 V, 250 A
1 jumper, 250 A
4 ... 5 jumpers, 236 A
(see Section 15)

Please observe the application notes:
Marking, from page 684

Approvals and corresponding ratings,
visit www.wago.com

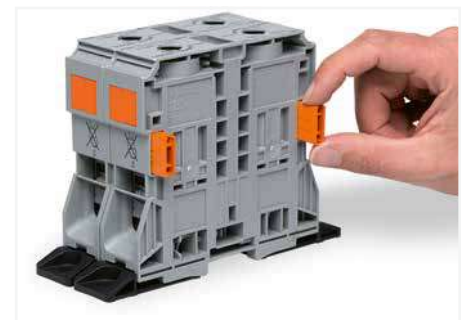

Optionally, insert block-to-block connector (285-1179) into housing slot.

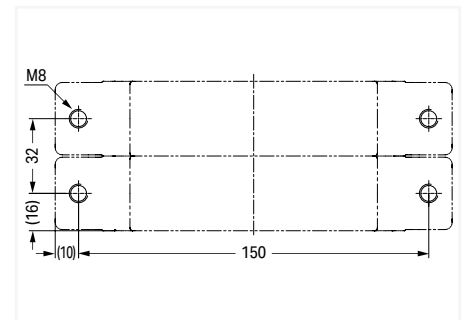

Dimensions (in mm):
Drill hole separation distance



Secure the terminal block to a mounting plate using two M8 cylinder-head screws and appropriate washers.

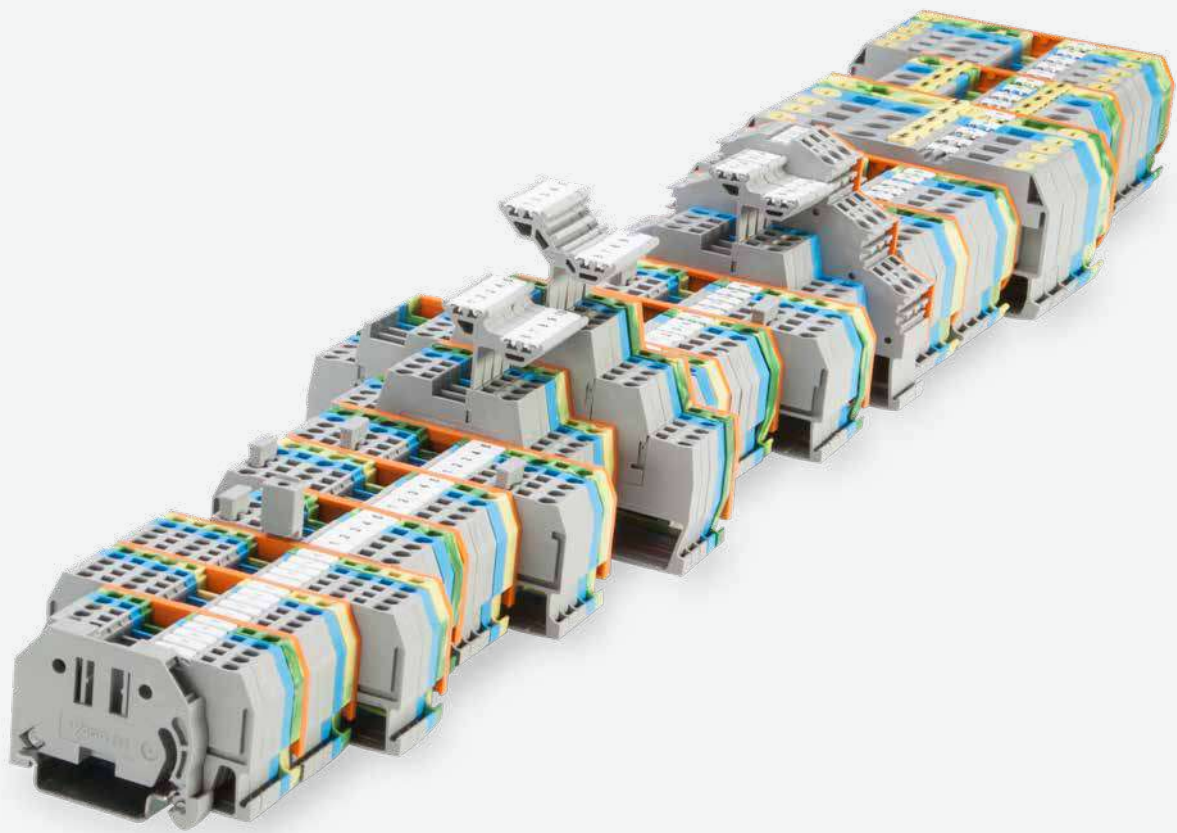

WAGO Rail-Mount Terminal Blocks Classic
WAGO Installation Rail-Mount Terminal
Blocks TOPJOB® Classic

WAGO Rail-Mount Terminal Blocks Classic

WAGO Installation Rail-Mount Terminal Blocks TOPJOB® Classic

			Page
	Through/Ground Conductor/Shield Conductor and Ex Terminal Blocks	279 ... 285 Series	312
	0.08 ... 35 mm ² (28 ... 2 AWG) Distribution Terminal Blocks	284 Series	325
	10 mm ² (8 AWG) / 35 mm ² (2 AWG)		
	Multilevel Rail-Mount Terminal Blocks	279/280/281 Series	328
	1.5/2.5/4 mm ² (16/12 AWG)		
	TOPJOB® Classic	780 ... 785 Series	334
	Through/Ground Conductor/Shield Conductor and Ex Terminal Blocks		
	0.08 ... 35 mm ² (28 ... 2 AWG)		
	Disconnect/Test Terminal Blocks	280/281/282 Series	352
	0.08 ... 4 mm ² (28 ... 12 AWG) and 0.2 ... 6 mm ² (24 ... 10 AWG)		
	Disconnect/Ground Conductor Disconnect and Fuse Terminal Blocks	282 Series	368
	0.2 ... 6 mm ² (24 ... 10 AWG)		
	Fused Disconnect Terminal Blocks with a Pivoting Fuse Holder	281 Series	374
	0.08 ... 4 mm ² (28 ... 12 AWG)		
	Fused Disconnect Terminal Blocks for Cylindrical Fuses	811 Series	382
	2.5 ... 16 mm ² (14 ... 6 AWG)		
	Fuse Plugs on Carrier Terminal Blocks	281/280 Series	378
	Sensor and Actuator Terminal Blocks	280 Series	390
	0.08 ... 2.5 mm ² (28 ... 12 AWG)		
	Diode and LED Terminal Blocks	279/280/281 Series	406
	0.08 ... 4 mm ² (28 ... 12 AWG)		
	Multilevel Diode and LED Terminal Blocks	280/281 Series	412
	0.08 ... 4 mm ² (28 ... 12 AWG)		
	Diode and LED Modules	280 Series	416
	Accessories for Rail-Mount Terminal Blocks		420

Rail-Mount Terminal Blocks Classic

279 ... 285 Series

Description and Installation



By snapping a ground conductor terminal block onto the DIN-rail, a direct electrical connection is automatically made to the rail.

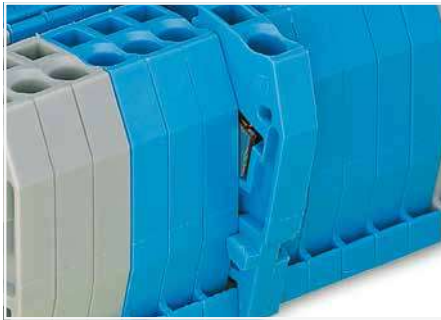

Quick assembly keys prevent reverse mounting.



Removing a terminal block from the assembly.

6

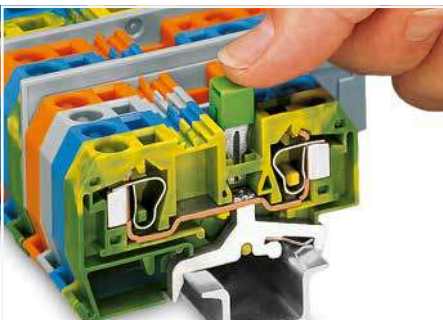

Commoning ground conductor terminal blocks with through terminal blocks is possible in one direction only (via rear side of terminal block) using adjacent jumpers. Recommends using yellow-green adjacent jumpers in addition to the required marking of these blocks.



Commoning terminal blocks of different sizes via step-down jumpers.

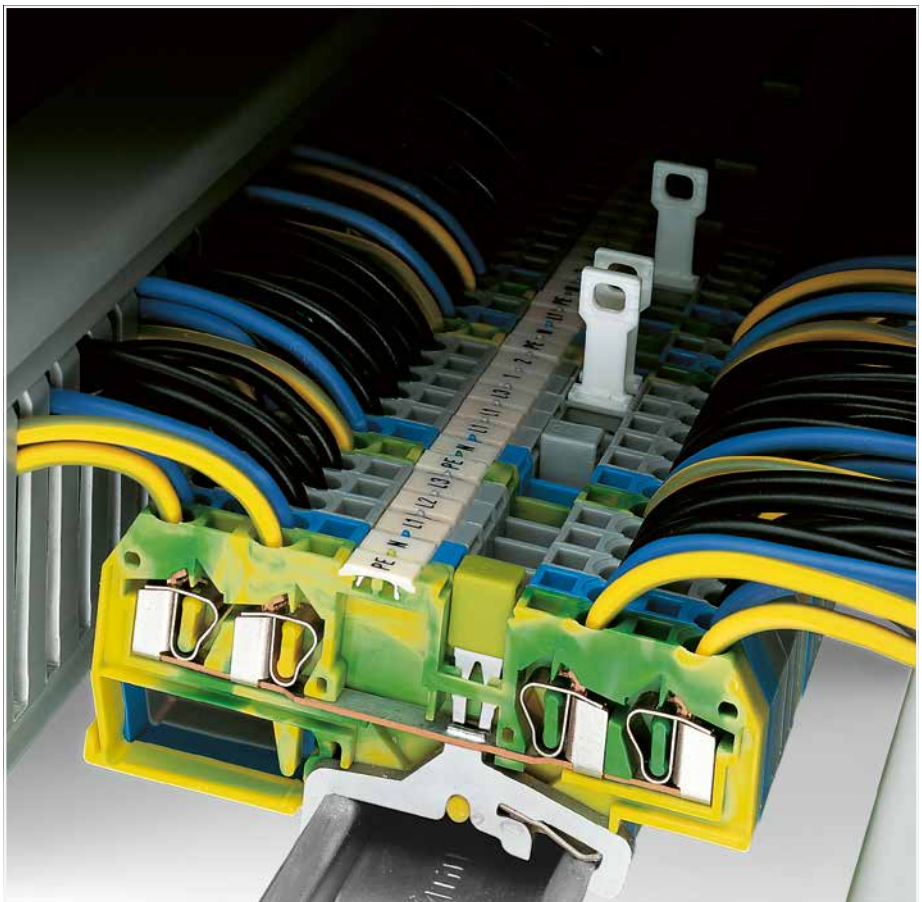

Steel DIN-rails are not suited for PEN (ground and N-conductor) applications per EN 60947-7-2 (VDE 0611, Part 3).

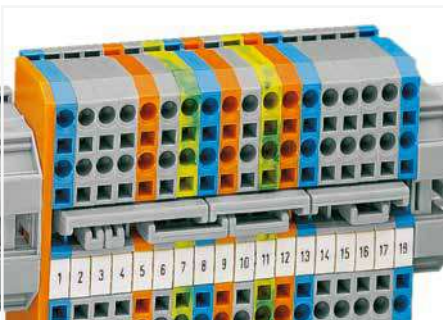

Staggered jumpers for sophisticated circuit requirements – push jumpers down until fully inserted.

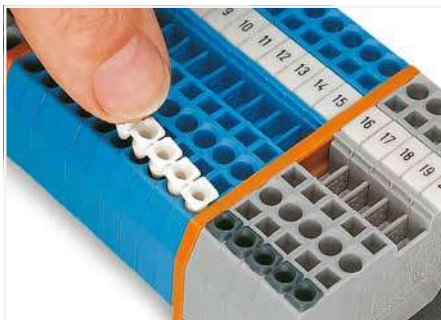

Inserting insulation stops.

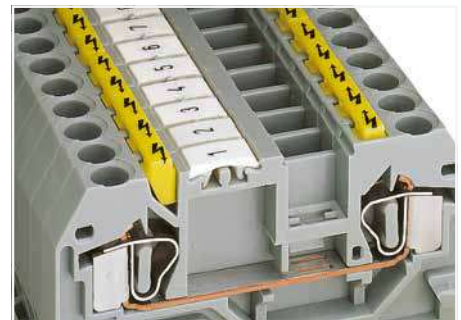

Protective warning markers inserted into the operating slots



CAGE CLAMP® terminates the following copper conductors: solid "s"



stranded "st"



fine-stranded "f-st", also with tinned single strands

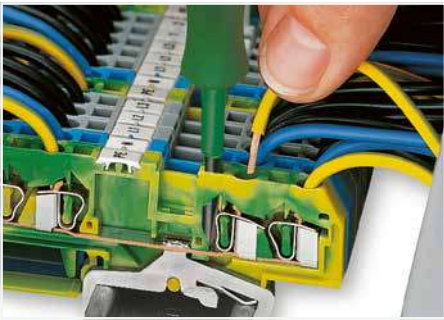

CAGE CLAMP® connection
Inserting a conductor.



CAGE CLAMP® connection
Inserting a conductor.
With ferruled conductors, it is necessary to use a terminal block one size larger than the conductor's nominal cross section.



Testing with a test plug.
(picture shows a test plug fitted with CAGE CLAMP®)

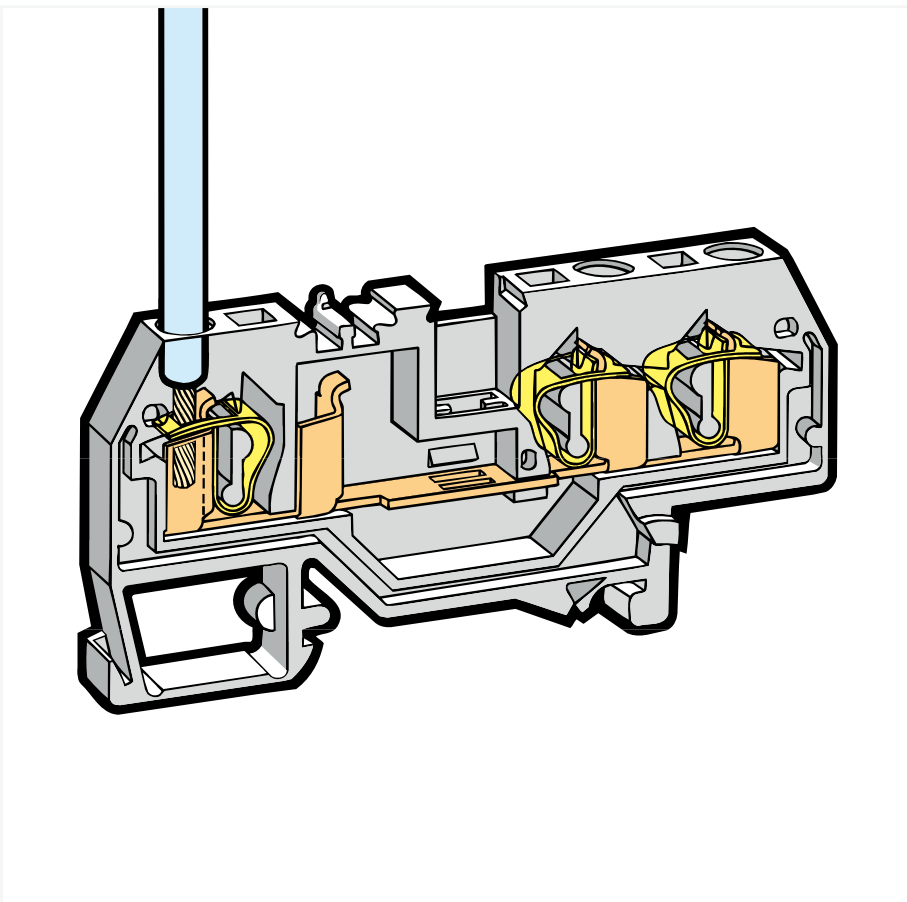

L-type test plug modules fitted with CAGE CLAMP®

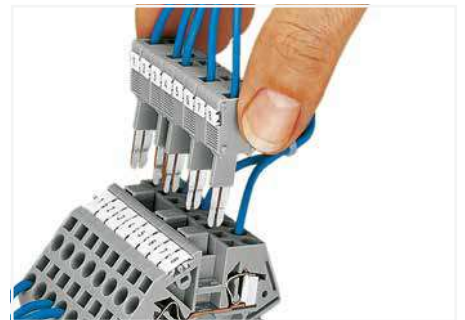

B-type test plug modules fitted with CAGE CLAMP®



Labeling via WMB Multi Marking System.



Testing with a test plug.
(picture shows 209-170 Test Plug Adapter)



fine-stranded,
tip-bonded



fine-stranded,
with ferrule
(gastight crimped)



fine-stranded,
with pin terminal
(gastight crimped)

Through/Ground Conductor/Shield Conductor/Ex and Double-Potential Terminal Block 1.5 mm²; 279 Series

Technical Data	
0.08 ... 1.5 mm ²	28 ... 16 AWG
800 V / 8 kV / 3 Ⓢ	600 V, 10 A
I _N 18 A	600 V, 10 A Ⓢ
Terminal block width: 4 mm / 0.157 inch	
8 ... 9 mm / 0.31 ... 0.35 inch	

Technical Data	
0.08 ... 1.5 mm ²	28 ... 16 AWG
800 V / 8 kV / 3 Ⓢ	600 V, 10 A
I _N 18 A	600 V, 10 A Ⓢ
Terminal block width: 4 mm / 0.157 inch	
8 ... 9 mm / 0.31 ... 0.35 inch	

Technical Data	
0.08 ... 1.5 mm ²	28 ... 16 AWG
800 V / 8 kV / 3 Ⓢ	600 V, 10 A
I _N 18 A	600 V, 10 A Ⓢ
Terminal block width: 4 mm / 0.157 inch	
8 ... 9 mm / 0.31 ... 0.35 inch	

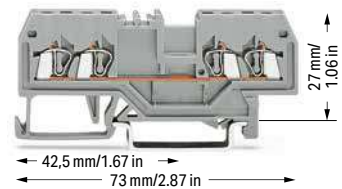
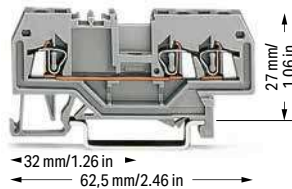
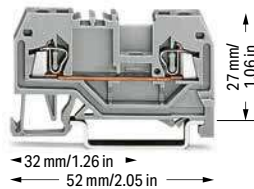

2-conductor through terminal block

Color	Item No.	Pack. Unit
gray	279-901	100
blue	279-904 ②	100
orange	279-902	100
red	279-903	100
black	279-905	100
yellow	279-906	100
light gray Ⓢ	279-992 ③	100

3-conductor through terminal block

Color	Item No.	Pack. Unit
gray	279-681	100
blue	279-684 ②	100
orange	279-682	100
red	279-683	100
black	279-685	100
yellow	279-686	100
light gray Ⓢ	279-993 ③	100

4-conductor through terminal block

Color	Item No.	Pack. Unit
gray	279-831	100
blue	279-834 ②	100
orange	279-832	100
red	279-833	100
black	279-835	100
yellow	279-836	100
light gray Ⓢ	279-994 ③	100

2-conductor ground terminal block

green-yellow	279-907	100
green-yellow Ⓢ	279-907/999-950 ④	100

3-conductor ground terminal block

green-yellow	279-687	100
green-yellow Ⓢ	279-687/999-950 ④	100

4-conductor ground terminal block

green-yellow	279-837	100
green-yellow Ⓢ	279-837/999-950 ④	100

4-conductor shield terminal block

white	279-838	100
-------	---------	-----

Other terminal blocks with the same profile:

Diode	279-915/281-410	Page 406
-------	-----------------	----------

Other terminal blocks with the same profile:

Diode	279-673/281-410	Page 406
LED	279-674/281-434	Page 406

Other terminal blocks with the same profile:

Diode	279-815/281-410	Page 406
LED	279-809/281-434	Page 406
Double-potential	279-826	Page 313

Accessories; item-specific

End and intermediate plate; 2 mm thick

orange	279-328	100 (25)
gray	279-325	100 (25)
light gray	279-330	100 (25)

Separator; oversized; 2 mm thick

orange	279-329	100 (25)
gray	279-326	100 (25)
light gray	279-331	100 (25)

Ex e/Ex i separator; orange; 3 mm thick

90 mm	209-190	50 (25)
120 mm	209-191	50 (25)

Accessories; item-specific

End and intermediate plate; 2 mm thick

orange	279-339	100 (25)
gray	279-308	100 (25)
light gray	279-341	100 (25)

Separator; oversized; 2 mm thick

orange	279-340	100 (25)
gray	279-309	100 (25)
light gray	279-342	100 (25)

Ex e/Ex i separator; orange; 3 mm thick

120 mm	209-191	50 (25)
--------	---------	---------

Accessories; item-specific

End and intermediate plate; 2 mm thick

orange	279-346	100 (25)
gray	279-344	100 (25)
light gray	279-348	100 (25)

Separator; oversized; 2 mm thick

orange	279-347	100 (25)
gray	279-345	100 (25)
light gray	279-349	100 (25)

Ex e/Ex i separator; orange; 3 mm thick

120 mm	209-191	50 (25)
--------	---------	---------

Step-down cover plate; 1 mm thick

gray	284-336	100 (25)
orange	284-346	100 (25)

Accessories; 279 Series

Appropriate marking systems: WMB/WMB Inline/WFB

Insulation stop; 0.08 ... 0.2 mm² "s" (0.14 mm² "f-st"); 5 pcs/strip

white	279-470	200 (25)
-------	---------	----------

Insulation stop; 0.25 mm²; 5 pcs/strip

dark gray	279-471	200 (25)
-----------	---------	----------

Adjacent jumper; insulated; I_N 15 A

gray	279-402	200 (25)
yellow-green	279-422	200 (25)

Alternate jumper; insulated; I_N 15 A

gray	279-409	100 (25)
------	---------	----------

Technical Data

0.08 ... 1.5 mm ²	28 ... 16 AWG
800 V / 8 kV / 3 ①	600 V, 10 A ②
I _N 18 A	600 V, 10 A ③
Terminal block width: 4 mm / 0.157 inch	
8 ... 9 mm / 0.31 ... 0.35 inch	

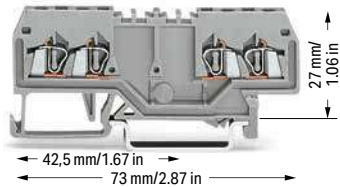

Double-potential terminal block; with double, center marking level

Color	Item No.	Pack. Unit
gray	279-826	100
light gray ④	279-995 ⑤	100

- ① 800 V = rated voltage
8 kV = rated impulse voltage
3 = pollution degree
(see Section 15)
- ② Terminal blocks with a blue insulated housing are suitable for Ex i applications.
- ③ Terminal blocks with an Ex mark are suitable for Ex e II applications.
0.2 ... 1.5 mm² / 24 ... 16 AWG
550 V; 15 A
(see Section 15)

Please observe the application notes:
Insulation stop, page 425
Push-in type wire jumper, page 427
Step-down jumper, page 327
Comb-style jumper bar, page 426
Marking, from page 684

Approvals and corresponding ratings, visit www.wago.com

Accessories; 279 Series

Appropriate marking systems:
WMB/WMB Inline/WFB

Push-in type wire jumper; insulated; 0.75 mm² conductor cross section; I_N 9 A

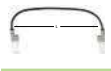

L = 60 mm	249-125	100 (10)
L = 110 mm	249-126	100 (10)
L = 250 mm	249-127	100 (10)

Step-down jumper; insulated; commons 10/6 mm² (8/10 AWG) down to 4/2.5/1.5 mm² (12/14/16 AWG); I_N 15 A



gray	284-414	50 (25)
------	---------	---------

Cover plate; 1 mm thick; for 2-, 3- and 4-conductor terminal blocks



gray	284-334	100 (25)
orange	284-344	100 (25)

Comb-style jumper bar; insulated; I_N = I_N of terminal block



2-way	279-482	200 (25)
3-way	279-483	200 (25)

Comb-style jumper bar; insulated; I_N = I_N of terminal block



10-way	279-490	50 (25)
--------	---------	---------

Alternate comb-style jumper bar; insulated; I_N = I_N of terminal block



2-way	279-492	200 (25)
-------	---------	----------

Operating tool; insulated



2-way	279-432	1
3-way	279-433	1

Operating tool; insulated



10-way	279-440	1
--------	---------	---

Test plug adapter; 8.3 mm wide; for 4 mm Ø test plug; for 1.5 ... 10 mm² terminal blocks



gray	209-170	50 (25)
------	---------	---------

Test plug adapter; 5 mm wide; for 4 mm Ø test plug; for 1.5 ... 4 mm² terminal blocks



gray	280-404	100 (25)
------	---------	----------

Accessories; item-specific

End and intermediate plate; 2 mm thick

orange	279-346	100 (25)
gray	279-344	100 (25)
light gray	279-348	100 (25)

Separator; oversized; 2 mm thick

orange	279-347	100 (25)
gray	279-345	100 (25)
light gray	279-349	100 (25)

Protective warning marker; with black high-voltage symbol; for 5 terminal blocks



yellow	279-415	100 (25)
--------	---------	----------

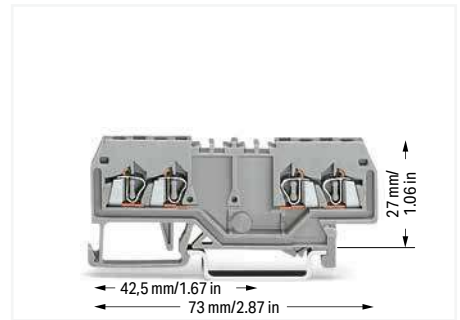

Notice: These double-potential terminal blocks cannot be commoned via adjacent jumpers!
Front-entry double-potential terminal blocks are space savers.
Two independent feedthrough circuits are placed in one insulated housing on one level in just 4 mm. This achieves a width of just 2 mm versus standard through terminal blocks.

Input and output of a circuit are placed on the same side of the terminal block. Both circuits can be individually marked according to input and output.

For technical data and accessories, see www.wago.com

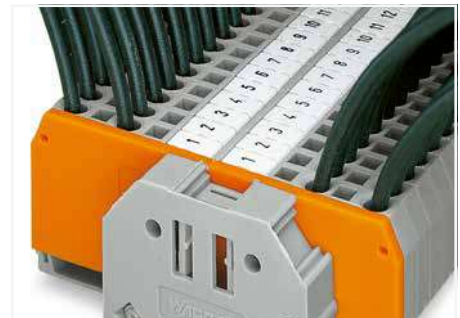

Marking directly on the terminal block via WMB markers.



Terminal block marking with double marker carriers (209-128)
Terminal blocks with side marking
(see online catalog at www.wago.com)

Through/Ground Conductor/Shield Conductor/Ex and Double-Potential Terminal Block 2.5 mm²; 280 Series

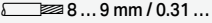
Technical Data	
0.08 ... 2.5 mm ²	28 ... 12 AWG*
800 V / 8 kV / 3 ①	600 V, 20 A ②
I _N 24 A	600 V, 25 A ③
Terminal block width: 5 mm / 0.197 inch	
 8 ... 9 mm / 0.31 ... 0.35 inch	

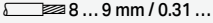
Technical Data	
0.08 ... 2.5 mm ²	28 ... 12 AWG*
800 V / 8 kV / 3 ①	600 V, 20 A ②
I _N 24 A	600 V, 15 A ③
Terminal block width: 5 mm / 0.197 inch	
 8 ... 9 mm / 0.31 ... 0.35 inch	

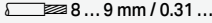
Technical Data	
0.08 ... 2.5 mm ²	28 ... 12 AWG*
800 V / 8 kV / 3 ①	600 V, 20 A ②
I _N 20 A	600 V, 25 A ③
Terminal block width: 5 mm / 0.197 inch	
 8 ... 9 mm / 0.31 ... 0.35 inch	

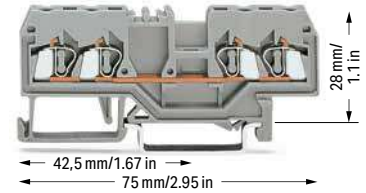
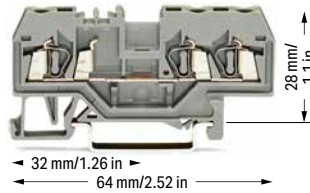
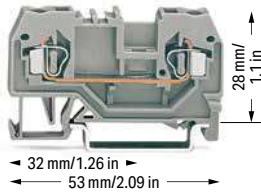

2-conductor through terminal block

Color	Item No.	Pack. Unit
gray	280-901	100
blue	280-904 ②	100
orange	280-902	100
red	280-903	100
black	280-905	100
yellow	280-906	100
light gray ⑤	280-992 ③	100

3-conductor through terminal block

Color	Item No.	Pack. Unit
gray	280-681	100
blue	280-684 ②	100
orange	280-650	100
red	280-653	100
black	280-671	100
yellow	280-672	100
light gray ⑤	280-993 ③	100

4-conductor through terminal block

Color	Item No.	Pack. Unit
gray	280-833	100
blue	280-834 ②	100
orange	280-835	100
red	280-830	100
black	280-831	100
yellow	280-832	100
light gray ⑤	280-994 ③	100

2-conductor ground terminal block

green-yellow	280-907	100
green-yellow ⑤	280-907/999-950 ④	100

3-conductor ground terminal block

green-yellow	280-687	100
green-yellow ⑤	280-687/999-950 ④	100

4-conductor ground terminal block

green-yellow	280-837	100
green-yellow ⑤	280-837/999-950 ④	100

4-conductor shield terminal block

white	280-838	100
-------	---------	-----

Other terminal blocks with the same profile:

Diode	280-915/281-410	Page 408
Disconnect	280-912	Page 354
Carrier	280-916	Page 380

Other terminal blocks with the same profile:

Diode	280-673/281-410	Page 408
Disconnect	280-683	Page 354
Carrier	280-610	Page 380

Other terminal blocks with the same profile:

Diode	280-815/281-410	Page 408
LED	280-809/281-434	Page 408
Disconnect	280-836	Page 354
Disc./test	280-829	Page 354
Carrier	280-816	Page 380
Double-potential	280-826	Page 315

Accessories; item-specific

End and intermediate plate; 2.5 mm thick

 orange	280-309	100 (25)
 gray	280-308	100 (25)
 light gray	280-356	100 (25)

Separator; oversized; 2 mm thick

 orange	280-311	100 (25)
 gray	280-310	100 (25)
 light gray	280-357	100 (25)

Ex e/Ex i separator; orange; 3 mm thick

 90 mm	209-190	50 (25)
 120 mm	209-191	50 (25)

Spacer with same profile; for 2-conductor terminal blocks of horizontal type; 5 mm thick

 orange	280-902/056-000	100 (25)
--	-----------------	----------

Accessories; item-specific

End and intermediate plate; 2.5 mm thick

 orange	280-326	100 (25)
 gray	280-324	100 (25)
 light gray	280-358	100 (25)

Separator; oversized; 2 mm thick

 orange	280-346	100 (25)
 gray	280-344	100 (25)
 light gray	280-359	100 (25)

Ex e/Ex i separator; orange; 3 mm thick

 120 mm	209-191	50 (25)
--	---------	---------

Spacer with same profile; for 3-conductor terminal blocks of horizontal type; 5 mm thick

 orange	280-650/056-000	100 (25)
--	-----------------	----------

Accessories; item-specific

End and intermediate plate; 2.5 mm thick

 orange	280-315	100 (25)
 gray	280-314	100 (25)
 light gray	280-352	100 (25)

Separator; oversized; 2 mm thick

 orange	280-335	100 (25)
 gray	280-334	100 (25)
 light gray	280-353	100 (25)

Ex e/Ex i separator; orange; 3 mm thick

 120 mm	209-191	50 (25)
--	---------	---------

Spacer with same profile; for 4-conductor terminal blocks of horizontal type; 5 mm thick

 orange	280-835/056-000	100 (25)
--	-----------------	----------

Step-down cover plate; 1 mm thick

 gray	284-336	100 (25)
 orange	284-346	100 (25)

Technical Data

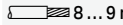
0.08 ... 2.5 mm ²	28 ... 12 AWG*
800 V / 8 kV / 3 ①	600 V, 20 A ②
I _N 24 A	600 V, 25 A ③
Terminal block width: 5 mm / 0.197 inch	
 8 ... 9 mm / 0.31 ... 0.35 inch	

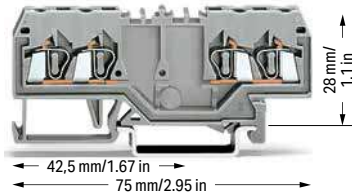

Double-potential terminal block; with double, center marking level

Color	Item No.	Pack. Unit
○ gray	280-826	100
○ light gray ③	280-995 ③	100

Notice: These double-potential terminal blocks cannot be commoned via adjacent jumpers!







Front-entry double-potential terminal blocks are space savers.

Two independent feedthrough circuits are placed in one insulated housing on one level in just 5 mm. This achieves a width of just 2.5 mm versus standard through terminal blocks.

Input and output of a circuit are placed on the same side of the terminal block. Both circuits can be individually marked according to input and output.

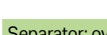
For technical data and accessories, see www.wago.com

Accessories; item-specific

End and intermediate plate; 2.5 mm thick		
	orange	280-315 100 (25)
	gray	280-314 100 (25)
	light gray	280-352 100 (25)
Separator; oversized; 2 mm thick		
	orange	280-335 100 (25)
	gray	280-334 100 (25)
	light gray	280-353 100 (25)

* 12 AWG: THHN, THWN

- 800 V = rated voltage
8 kV = rated impulse voltage
3 = pollution degree
(see Section 15)
- Terminal blocks with a blue insulated housing are suitable for Ex i applications.
- Terminal blocks with an Ex mark are suitable for Ex e II applications.
0.2 ... 2.5 mm²/24 ... 12 AWG*
550 V
23 A, for 2-conductor terminal blocks
22 A, for 3-conductor terminal blocks
20 A, for 4-conductor terminal blocks
(see Section 15)
Using staggered jumpers reduces the maximum rated voltage to 275 V.

Please observe the application notes:
Insulation stop, page 425
Jumpers, from page 426
Step-down jumper, page 327
Comb-style jumper bar, page 426
Testing accessories, from page 420
Marking, from page 684

Approvals and corresponding ratings, visit www.wago.com

Accessories; 280 Series

Appropriate marking systems:
WMB/WMB Inline/WFB

Insulation stop; 0.08 ... 0.2 mm² "s" (0.14 mm² "f-st"); 5 pcs/strip

	white	280-470	200 (25)
---	-------	---------	----------

Insulation stop; 0.25 ... 0.5 mm²; 5 pcs/strip

	light gray	280-471	200 (25)
---	------------	---------	----------

Insulation stop; 0.75 ... 1 mm²; 5 pcs/strip

	dark gray	280-472	200 (25)
---	-----------	---------	----------

Protective warning marker; with black high-voltage symbol; for 5 terminal blocks

	yellow	280-415	100 (25)
---	--------	---------	----------

Adjacent jumper; insulated; I_N = I_N terminal block

	gray	280-402	200 (25)
	yellow-green	280-422	200 (25)

Alternate jumper, insulated; I_N = I_N terminal block

	gray	280-409	100 (25)
---	------	---------	----------

Staggered jumper; insulated; 5 mm wide; I_N 24 A

	1 to 2	780-452	100 (25)
	1 to 3	780-453	100 (25)
	1 to 4	780-454	100 (25)
	1 to 5	780-455	50 (25)
	1 to 6	780-456	50 (25)
	1 to 7	780-457	50 (25)
	1 to 8	780-458	50 (25)

Push-in type wire jumper; insulated; 0.75 mm² conductor cross section; I_N 9 A

	L = 60 mm	249-125	100 (10)
	L = 110 mm	249-126	100 (10)
	L = 250 mm	249-127	100 (10)

Accessories; 280 Series

Appropriate marking systems:
WMB/WMB Inline/WFB

Step-down jumper; insulated; commons 10/6 mm² (8/10 AWG) down to 4/2.5/1.5 mm² (12/14/16 AWG); I_N 15 A

	gray	284-414	50 (25)
---	------	---------	---------

Cover plate; 1 mm thick; for 2-, 3- and 4-conductor terminal blocks

	gray	284-334	100 (25)
	orange	284-344	100 (25)

Comb-style jumper bar; insulated; I_N = I_N of terminal block

	2-way	280-482	200 (25)
	3-way	280-483	200 (25)

Comb-style jumper bar; insulated; I_N = I_N of terminal block

	10-way	280-490	50 (25)
---	--------	---------	---------

Alternate comb-style jumper bar; insulated; I_N = I_N of terminal block

	2-way	280-492	200 (25)
---	-------	---------	----------

Operating tool; insulated

	2-way	280-432	1
	3-way	280-433	1

Operating tool; insulated

	10-way	280-440	1
---	--------	---------	---

Test plug module; snaps together; 5 mm wide

	gray	280-418	100 (25)
---	------	---------	----------

Spacer module; snaps together; 5 mm wide

	gray	280-419	100 (25)
---	------	---------	----------

Test plug adapter; 8.3 mm wide; for 4 mm Ø test plug; for 1.5 ... 10 mm² terminal blocks

	gray	209-170	50 (25)
---	------	---------	---------

Test plug adapter; 5 mm wide; for 4 mm Ø test plug; for 1.5 ... 4 mm² terminal blocks

	gray	280-404	100 (25)
---	------	---------	----------

Test plug adapter; 6 mm wide; with CAGE CLAMP®; for 0.08 ... 2.5 mm²

	I _N 24 A	281-407	100 (25)
---	---------------------	---------	----------

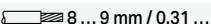

Through/Ground Conductor/Shield Conductor and Ex Terminal Block 2.5 mm²; 280 Series

Technical Data

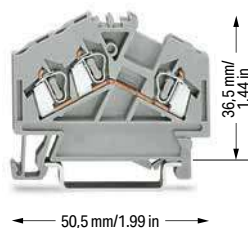

0.08 ... 2.5 mm ²	28 ... 12 AWG*
800 V / 8 kV / 3 ①	600 V, 20 A ②
I _N 24 A	
Terminal block width: 5 mm / 0.197 inch	
 8 ... 9 mm / 0.31 ... 0.35 inch	



3-conductor through terminal block

Color	Item No.	Pack. Unit
 gray	280-641	100
 blue	280-651 ②	100
 orange	280-654	100
 light gray ③	280-998 ③	100

3-conductor ground terminal block

 green-yellow	280-637	100
 green-yellow ③	280-637/999-950 ③	100

3-conductor shield terminal block

 white	280-640	100
--	---------	-----

Accessories; 280 Series

Appropriate marking systems:
WMB/WMB Inline/WFB

End and intermediate plate; 2.5 mm thick

 orange	280-313	100 (25)
 gray	280-312	100 (25)
 light gray	280-354	100 (25)

Separator; oversized; 2 mm thick

 orange	280-318	100 (25)
 gray	280-348	100 (25)
 light gray	280-355	100 (25)

Ex e/Ex i separator; orange; 3 mm thick

 120 mm	209-191	50 (25)
--	---------	---------

Spacer with same profile; for 3- and 4-conductor terminal blocks (angled type); 5 mm thick

 orange	280-654/056-000	100 (25)
--	-----------------	----------

Insulation stop; 0.08 ... 0.2 mm² "s" (0.14 mm² "f-st"); 5 pcs/strip

 white	280-470	200 (25)
---	---------	----------

Insulation stop; 0.25 ... 0.5 mm²; 5 pcs/strip

 light gray	280-471	200 (25)
--	---------	----------

Insulation stop; 0.75 ... 1 mm²; 5 pcs/strip

 dark gray	280-472	200 (25)
---	---------	----------

* 12 AWG: THHN, THWN

- 800 V = rated voltage
8 kV = rated impulse voltage
3 = pollution degree
(see Section 15)
- Terminal blocks with a blue insulated housing are suitable for Ex i applications.
- Terminal blocks with an Ex mark are suitable for Ex e II applications.
0.2 ... 2.5 mm² / 24 ... 12 AWG*
550 V; 23 A
(see Section 15)
Using staggered jumpers reduces the maximum rated voltage to 275 V.

- Please observe the application notes:
Insulation stop, page 425
Jumpers, from page 426
Comb-style jumper bar, page 426
Testing accessories, from page 420
Marking, from page 684

Approvals and corresponding ratings,
visit www.wago.com

Accessories; 280 Series

Appropriate marking systems:
WMB/WMB Inline/WFB

Adjacent jumper; insulated; I_N = I_N terminal block

 gray	280-402	200 (25)
 yellow-green	280-422	200 (25)

Alternate jumper; insulated; I_N = I_N terminal block

 gray	280-409	100 (25)
--	---------	----------

Staggered jumper; insulated; 5 mm wide; I_N 24 A

 1 to 2	780-452	100 (25)
1 to 3	780-453	100 (25)
1 to 4	780-454	100 (25)
1 to 5	780-455	50 (25)
1 to 6	780-456	50 (25)
1 to 7	780-457	50 (25)
1 to 8	780-458	50 (25)

Push-in type wire jumper; insulated; 0.75 mm² conductor cross section; I_N 9 A

 L = 60 mm	249-125	100 (10)
L = 110 mm	249-126	100 (10)
L = 250 mm	249-127	100 (10)

Comb-style jumper bar; insulated; I_N = I_N of terminal block

 2-way	280-482	200 (25)
3-way	280-483	200 (25)

Comb-style jumper bar; insulated; I_N = I_N of terminal block

 10-way	280-490	50 (25)
--	---------	---------

Alternate comb-style jumper bar; insulated; I_N = I_N of terminal block

 2-way	280-492	200 (25)
---	---------	----------

Operating tool; insulated

 2-way	280-432	1
3-way	280-433	1
10-way	280-440	1

Protective warning marker; with black high-voltage symbol; for 5 terminal blocks

 yellow	280-415	100 (25)
--	---------	----------

Accessories; 280 Series

Appropriate marking systems:
WMB/WMB Inline/WFB

Test plug module; snaps together; 5 mm wide

 gray	280-418	100 (25)
--	---------	----------

Spacer module; snaps together; 5 mm wide

 gray	280-419	100 (25)
--	---------	----------

Test plug adapter; 8.3 mm wide; for 4 mm Ø test plug; for 1.5 ... 10 mm² terminal blocks

 gray	209-170	50 (25)
--	---------	---------

Test plug adapter; 5 mm wide; for 4 mm Ø test plug; for 1.5 ... 4 mm² terminal blocks

 gray	280-404	100 (25)
--	---------	----------

Test plug adapter; 6 mm wide; with CAGE CLAMP®; for 0.08 ... 2.5 mm²

 I _N 24 A	281-407	100 (25)
---	---------	----------

WMB Inline, plain; 1,500 WMB markers (5 mm)/reel; 5 ... 5.2 mm stretchable

 white	2009-115	1
---	----------	---

WMB marking card; white; 10 strips with 10 markers/card; stretchable 5 ... 5.2 mm

 plain	793-5501	5
---	----------	---

Through and Ex Terminal Block 2.5 mm²; 280 Series

Technical Data

0.08 ... 2.5 mm ²	28 ... 12 AWG*
800 V / 8 kV / 3 ①	600 V, 20 A ②
I _N 24 A	600 V, 25 A ③
Terminal block width: 5 mm / 0.197 inch	
8 ... 9 mm / 0.31 ... 0.35 inch	

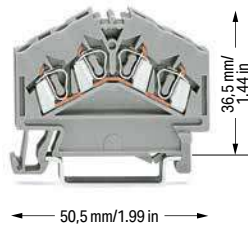

4-conductor through terminal block
Notice: These terminal blocks cannot be commoned using adjacent jumpers.

Color	Item No.	Pack. Unit
gray	280-646	100
blue	280-656 ②	100
orange	280-946	100
light gray ③	280-996 ③	100

Accessories; 280 Series

Appropriate marking systems:
WMB/WMB Inline/WFB

End and intermediate plate; 2.5 mm thick

	orange	280-313	100 (25)
	gray	280-312	100 (25)
	light gray	280-354	100 (25)

Separator; oversized; 2 mm thick

	orange	280-318	100 (25)
	gray	280-348	100 (25)
	light gray	280-355	100 (25)

Ex e/Ex i separator; orange; 3 mm thick

	120 mm	209-191	50 (25)
--	--------	---------	---------

Spacer with same profile; for 3- and 4-conductor terminal blocks (angled type); 5 mm thick

	orange	280-654/056-000	100 (25)
--	--------	-----------------	----------

Insulation stop; 0.08 ... 0.2 mm² "s" (0.14 mm² "f-st"); 5 pcs/strip

	white	280-470	200 (25)
--	-------	---------	----------

Insulation stop; 0.25 ... 0.5 mm²; 5 pcs/strip

	light gray	280-471	200 (25)
--	------------	---------	----------

Insulation stop; 0.75 ... 1 mm²; 5 pcs/strip

	dark gray	280-472	200 (25)
--	-----------	---------	----------

Protective warning marker; with black high-voltage symbol; for 5 terminal blocks

	yellow	280-415	100 (25)
--	--------	---------	----------

* 12 AWG: THHN, THWN

- 800 V = rated voltage
8 kV = rated impulse voltage
3 = pollution degree (see Section 15)
- Terminal blocks with a blue insulated housing are suitable for Ex i applications.
- Terminal blocks with an Ex mark are suitable for Ex e II applications.
0.2 ... 2.5 mm² / 24 ... 12 AWG*
550 V; 23 A (see Section 15)

Please observe the application notes:
Insulation stop, page 425
Comb-style jumper bar, page 426
Testing accessories, from page 420
Marking, from page 684

Approvals and corresponding ratings, visit www.wago.com

Accessories; 280 Series

Appropriate marking systems:
WMB/WMB Inline/WFB

Comb-style jumper bar; insulated; I_N = I_N of terminal block

	2-way	280-482	200 (25)
	3-way	280-483	200 (25)

Comb-style jumper bar; insulated; I_N = I_N of terminal block

	10-way	280-490	50 (25)
--	--------	---------	---------

Alternate comb-style jumper bar; insulated; I_N = I_N of terminal block

	2-way	280-492	200 (25)
--	-------	---------	----------

Operating tool; insulated

	2-way	280-432	1
	3-way	280-433	1

Operating tool; insulated

	10-way	280-440	1
--	--------	---------	---

Test plug module; snaps together; 5 mm wide

	gray	249-141	100 (25)
--	------	---------	----------

WMB Inline, plain; 1,500 WMB markers (5 mm)/reel; 5 ... 5.2 mm stretchable

	white	2009-115	1
--	-------	----------	---

WMB marking card; white; 10 strips with 10 markers/card; stretchable 5 ... 5.2 mm

	plain	793-5501	5
--	-------	----------	---

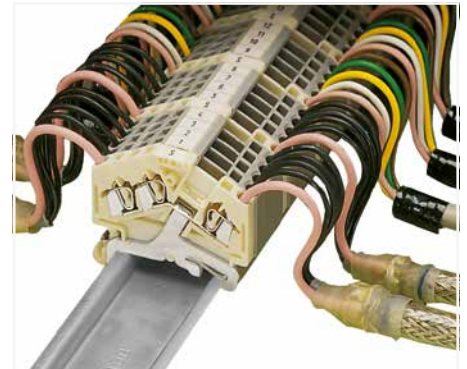

Application example for shield conductor terminal blocks

Shielded control cables are becoming an increasingly common solution to external signal interference. Front-entry shield conductor terminal blocks are ideal for connecting braided cables. Like front-entry ground conductor terminal blocks, they are equipped with a grounding foot for direct electrical connection to the rail, however they differ significantly by their white insulated housing. Shield conductor terminal blocks for front-entry wiring can be directly mounted beside signal-conductor terminal blocks, providing excellent deflection of interfering signals.

Through/Ground Conductor/Shield Conductor and Ex Terminal Block 4 mm²; 281 Series

Technical Data	
0.08 ... 4 mm ²	28 ... 12 AWG
800 V / 8 kV / 3 ①	600 V, 20 A ②
I _N 32 A	600 V, 25 A ③
Terminal block width: 6 mm / 0.236 inch	
9 ... 10 mm / 0.35 ... 0.39 inch	

Technical Data	
0.08 ... 4 mm ²	28 ... 12 AWG
800 V / 8 kV / 3 ①	600 V, 20 A ②
I _N 32 A	600 V, 25 A ③
Terminal block width: 6 mm / 0.236 inch	
9 ... 10 mm / 0.35 ... 0.39 inch	

Technical Data	
0.08 ... 4 mm ²	28 ... 12 AWG
800 V / 8 kV / 3 ①	600 V, 20 A ②
I _N 26 A	600 V, 25 A ③
Terminal block width: 6 mm / 0.236 inch	
9 ... 10 mm / 0.35 ... 0.39 inch	

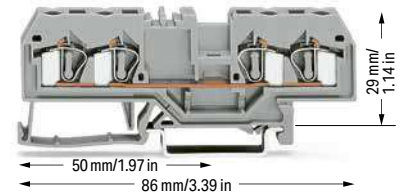
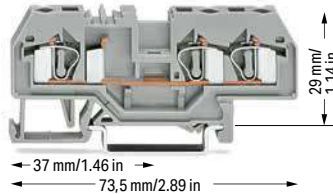
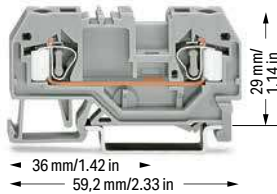

2-conductor through terminal block		
Color	Item No.	Pack. Unit
gray	281-901	50
blue	281-904 ②	50
orange	281-902	50
red	281-903	50
black	281-905	50
yellow	281-906	50
light gray ③	281-992 ③	50

3-conductor through terminal block		
Color	Item No.	Pack. Unit
gray	281-681	50
blue	281-684 ②	50
orange	281-678	50
red	281-679	50
black	281-685	50
yellow	281-686	50
light gray ③	281-993 ③	50

4-conductor through terminal block		
Color	Item No.	Pack. Unit
gray	281-652	50
blue	281-654 ②	50
orange	281-653	50
red	281-663	50
black	281-664	50
yellow	281-668	50
light gray ③	281-994 ③	50

2-conductor ground terminal block		
green-yellow	281-907	50
green-yellow ③	281-907/999-950 ③	50

3-conductor ground terminal block		
green-yellow	281-687	50
green-yellow ③	281-687/999-950 ③	50

4-conductor ground terminal block		
green-yellow	281-657	50
green-yellow ③	281-657/999-950 ③	50

4-conductor shield terminal block		
white	281-658	50

Other terminal blocks with the same profile:		
Diode	281-915/281-410	Page 410
Disconnect	281-912	Page 356
Carrier	281-916	Page 378

Other terminal blocks with the same profile:		
Diode	281-673/281-410	Page 410
Disconnect	281-683	Page 356
Carrier	281-610	Page 378

Other terminal blocks with the same profile:		
Diode	281-665/281-410	Page 410
Disconnect	281-659	Page 356
Disc./test	281-666	Page 356
Carrier	281-656	Page 378

Accessories; item-specific			
End and intermediate plate; 2.5 mm thick			
	orange	281-329	100 (25)
	gray	281-328	100 (25)
	light gray	281-349	100 (25)
Separator; oversized; 2 mm thick			
	orange	281-331	100 (25)
	gray	281-330	100 (25)
	light gray	281-350	100 (25)
Ex e/Ex i separator; orange; 3 mm thick			
	90 mm	209-190	50 (25)
	120 mm	209-191	50 (25)

Accessories; item-specific			
End and intermediate plate; 2.5 mm thick			
	orange	281-326	100 (25)
	gray	281-324	100 (25)
	light gray	281-355	100 (25)
Separator; oversized; 2 mm thick			
	orange	281-346	100 (25)
	gray	281-344	100 (25)
	light gray	281-356	100 (25)
Ex e/Ex i separator; orange; 3 mm thick			
	120 mm	209-191	50 (25)

Accessories; item-specific			
End and intermediate plate; 2.5 mm thick			
	orange	281-335	100 (25)
	gray	281-334	100 (25)
	light gray	281-345	100 (25)
Separator; oversized; 2 mm thick			
	orange	281-339	100 (25)
	gray	281-338	100 (25)
	light gray	281-347	100 (25)
Ex e/Ex i separator; orange; 3 mm thick			
	120 mm	209-191	50 (25)
Step-down cover plate; 1 mm thick			
	gray	284-336	100 (25)
	orange	284-346	100 (25)

Accessories; 281 Series

Appropriate marking systems: WMB/WMB Inline/WFB

Insulation stop; 0.08 ... 0.2 mm ² "s" (0.14 mm ² "f-st"); 5 pcs/strip		
	white	281-470 200 (25)

Insulation stop; 0.25 ... 0.5 mm ² ; 5 pcs/strip		
	light gray	281-471 200 (25)

Insulation stop; 0.75 ... 1.5 mm ² ; 5 pcs/strip		
	dark gray	281-472 200 (25)

Technical Data

0.08 ... 4 mm ²	28 ... 12 AWG
800 V / 8 kV / 3 ①	600 V, 20 A ②
I _N 32 A	600 V, 25 A ③
Terminal block width: 6 mm / 0.236 inch	
9 ... 10 mm / 0.35 ... 0.39 inch	

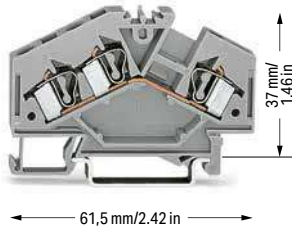

3-conductor through terminal block

Color	Item No.	Pack. Unit
gray	281-631	100
blue	281-651 ②	100
light gray ③	281-998 ③	100

3-conductor ground terminal block

green-yellow	281-637	100
green-yellow ③	281-637/999-950 ③	100

Accessories; item-specific

End and intermediate plate; 2.5 mm thick

	orange	281-313	100 (25)
	gray	281-312	100 (25)
	light gray	281-357	100 (25)

Separator; oversized; 2 mm thick

	orange	281-318	100 (25)
	gray	281-348	100 (25)
	light gray	281-358	100 (25)

Protective warning marker; with black high-voltage symbol; for 5 terminal blocks

	yellow	281-415	100 (25)
--	--------	---------	----------

① 800 V = rated voltage
8 kV = rated impulse voltage
3 = pollution degree (see Section 15)

② Terminal blocks with a blue insulated housing are suitable for Ex i applications.

③ Terminal blocks with an Ex mark are suitable for Ex e II applications.
0.2 ... 4 mm² / 24 ... 12 AWG
550 V; 30 A (see Section 15)
Using staggered jumpers reduces the maximum rated voltage to 275 V.

Please observe the application notes:
Insulation stop, page 425
Jumpers, from page 426
Comb-style jumper bar, page 426
Testing accessories, from page 420
Marking, from page 684

Approvals and corresponding ratings, visit www.wago.com

Accessories; 281 Series

Appropriate marking systems:
WMB/WMB Inline/WFB

Adjacent jumper; insulated; I_N = I_N terminal block

	gray	281-402	200 (25)
	yellow-green	281-422	200 (25)

Alternate jumper, insulated; I_N = I_N terminal block

	gray	281-409	100 (25)
--	------	---------	----------

Staggered jumper; insulated; 6 mm wide; I_N 32 A

	1 to 2	781-452	100 (25)
	1 to 3	781-453	100 (25)
	1 to 4	781-454	100 (25)
	1 to 5	781-455	50 (25)
	1 to 6	781-456	50 (25)

Push-in type wire jumper; insulated; 0.75 mm² conductor cross section; I_N 9 A

	L = 60 mm	249-125	100 (10)
	L = 110 mm	249-126	100 (10)
	L = 250 mm	249-127	100 (10)

Step-down jumper; insulated; commons 10/6 mm² (8/10 AWG) down to 6/4 mm² (10/12 AWG); I_N 30 A

	gray	284-413	50 (25)
--	------	---------	---------

Cover plate; 1 mm thick; for 2-, 3- and 4-conductor terminal blocks

	gray	284-334	100 (25)
	orange	284-344	100 (25)

Comb-style jumper bar; insulated; I_N = I_N of terminal block

	2-way	281-482	100 (25)
	3-way	281-483	100 (25)
	5-way	281-485	100 (25)
	10-way	281-490	50 (25)

Alternate comb-style jumper bar; insulated; I_N = I_N of terminal block

	2-way	281-492	100 (25)
--	-------	---------	----------

Operating tool; insulated

	2-way	280-432	1
	3-way	280-433	1
	5-way	281-440	1

Accessories; 281 Series

Appropriate marking systems:
WMB/WMB Inline/WFB

Test plug module; snaps together; 6 mm wide

	gray	281-418	100 (25)
--	------	---------	----------

Spacer module; snaps together; 6 mm wide

	gray	281-419	100 (25)
--	------	---------	----------

Test plug adapter; 8.3 mm wide; for 4 mm Ø test plug; for 1.5 ... 10 mm² terminal blocks

	gray	209-170	50 (25)
--	------	---------	---------

Test plug adapter; 5 mm wide; for 4 mm Ø test plug; for 1.5 ... 4 mm² terminal blocks

	gray	280-404	100 (25)
--	------	---------	----------

Test plug adapter; 6 mm wide; with CAGE CLAMP®; for 0.08 ... 2.5 mm²

	I _N 24 A	281-407	100 (25)
--	---------------------	---------	----------

WMB Inline, plain; 1,500 WMB markers (5 mm)/reel; 5 ... 5.2 mm stretchable

	white	2009-115	1
--	-------	----------	---

WMB marking card; white; 10 strips with 10 markers/card; stretchable 5 ... 5.2 mm

	plain	793-5501	5
--	-------	----------	---

Through/Ground Conductor and Ex Terminal Block 6 mm²; 282 Series

Technical Data

0.2 ... 6 mm ²	24 ... 10 AWG
800 V / 8 kV / 3 ①	600 V, 30 A W
I _N 41 A	600 V, 40 A Ⓞ
Terminal block width: 8 mm / 0.315 inch	
12 ... 13 mm / 0.47 ... 0.51 inch	

Technical Data

0.2 ... 6 mm ²	24 ... 10 AWG
800 V / 8 kV / 3 ①	600 V, 30 A W
I _N 41 A	600 V, 40 A Ⓞ
Terminal block width: 8 mm / 0.315 inch	
12 ... 13 mm / 0.47 ... 0.51 inch	

- ① 800 V = rated voltage
8 kV = rated impulse voltage
3 = pollution degree
(see Section 15)
- ② Terminal blocks with a blue insulated housing are suitable for Ex i applications.
- ③ Terminal blocks with an Ex mark are suitable for Ex e II applications.
0.5 ... 6 mm² / 20 ... 10 AWG
550 V; 39 A
35 A jumper
(see Section 15)

Please observe the application notes:
Step-down jumper, page 327
Test plug module, page 423
Marking, from page 684

Approvals and corresponding ratings,
visit www.wago.com

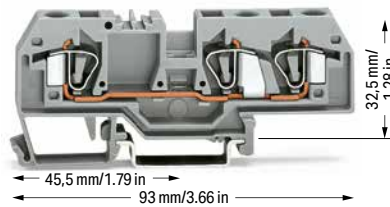
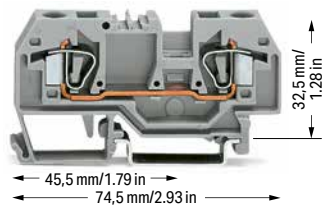

2-conductor through terminal block

Color	Item No.	Pack. Unit
gray	282-901	50
blue	282-904 ②	50
orange	282-902	50
red	282-903	50
black	282-905	50
yellow	282-906	50
light gray Ⓞ	282-992 ③	50

3-conductor through terminal block

Color	Item No.	Pack. Unit
gray	282-681	25
blue	282-684 ②	25
orange	282-682	25
light gray Ⓞ	282-993 ③	50

2-conductor ground terminal block

green-yellow	282-907	50
green-yellow Ⓞ	282-907/999-950 ③	50

3-conductor ground terminal block

green-yellow	282-687	25
green-yellow Ⓞ	282-687/999-950 ③	25

Accessories; item-specific

End and intermediate plate; 2.5 mm thick

orange	282-328	100 (25)
gray	282-325	100 (25)
light gray	282-330	100 (25)

Accessories; item-specific

End and intermediate plate; 2.5 mm thick

orange	282-339	100 (25)
gray	282-308	100 (25)
light gray	282-341	100 (25)

Separator; oversized; 2 mm thick

orange	282-329	100 (25)
gray	282-326	100 (25)
light gray	282-331	100 (25)

Separator; oversized; 2 mm thick

orange	282-340	100 (25)
gray	282-309	100 (25)
light gray	282-342	100 (25)

Step-down cover plate; 1 mm thick

gray	282-357	100 (25)
orange	282-367	100 (25)

Step-down cover plate; 1 mm thick

gray	282-358	100 (25)
orange	282-368	100 (25)

Accessories; 282 Series

Appropriate marking systems: WMB/WMB Inline/WFB

Ex e/Ex i separator; orange; 3 mm thick

120 mm	209-191	50 (25)
--------	---------	---------

Step-down jumper; insulated; commons 10/6 mm² (8/10 AWG) down to 4/2.5/1.5 mm² (12/14/16 AWG); I_N 15 A

gray	284-414	50 (25)
------	---------	---------

Protective warning marker; with black high-voltage symbol; for 5 terminal blocks

yellow	282-415	100 (25)
--------	---------	----------

Step-down jumper; insulated; commons 10/6 mm² (8/10 AWG) down to 6/4 mm² (10/12 AWG); I_N 30 A

gray	284-413	50 (25)
------	---------	---------

Adjacent jumper; insulated; I_N 41 A

gray	282-402	100 (25)
yellow-green	282-422	100 (25)

Test plug adapter; 8.3 mm wide; for 4 mm Ø test plug; for 1.5 ... 10 mm² terminal blocks

gray	209-170	50 (25)
------	---------	---------

Alternate jumper; insulated; I_N 41 A

gray	282-409	100 (25)
------	---------	----------

B-type test plug module; snaps together; 8 mm wide

gray	709-310	100 (25)
------	---------	----------

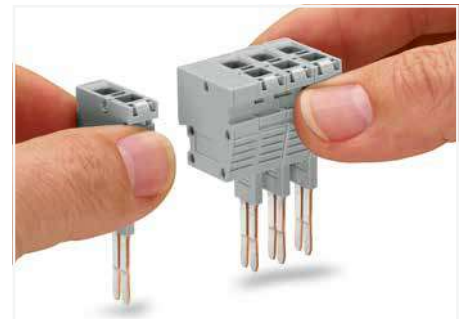

Snapping test plug and spacer modules together to assemble a multi-pole test plug module (max. 10 poles) for 8 mm terminal block width.

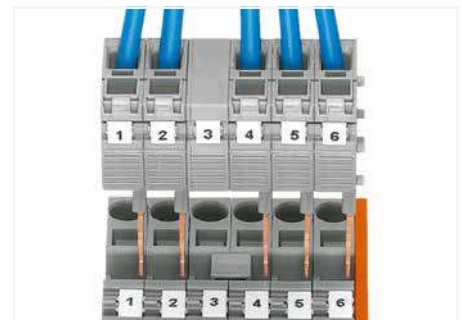

The test plug modules are directly plugged into the jumper contact slot of the current bar (picture shows 282 Series).

6

Through/Ground Conductor and Ex Terminal Block 10 mm²; 284 Series

Technical Data	
0.2 ... 10 mm ²	24 ... 8 AWG
800 V / 8 kV / 3 ①	600 V, 50 A VA
I _N 57 A	600 V, 54 A Ⓜ
Terminal block width: 10 mm / 0.394 inch	
12 ... 13 mm / 0.47 ... 0.51 inch	

Technical Data	
0.2 ... 10 mm ²	24 ... 8 AWG
800 V / 8 kV / 3 ①	600 V, 50 A VA
I _N 57 A	600 V, 54 A Ⓜ
Terminal block width: 10 mm / 0.394 inch	
12 ... 13 mm / 0.47 ... 0.51 inch	

- ① 800 V = rated voltage
8 kV = rated impulse voltage
3 = pollution degree
(see Section 15)
- ② Terminal blocks with an Ex mark are suitable for Ex e II applications.
0.5 ... 10 mm² / 20 ... 8 AWG
550 V; 53 A
(see Section 15)

Please observe the application notes:
Step-down jumper, page 327
Test plug module, page 423
Marking, from page 684

Approvals and corresponding ratings, visit www.wago.com

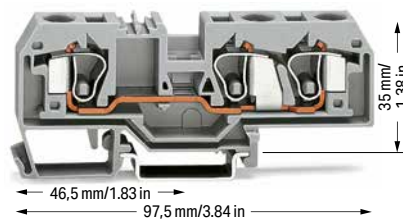
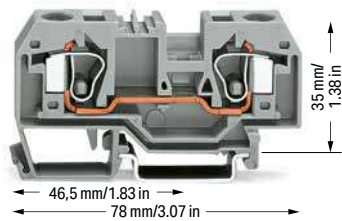

2-conductor through terminal block		
Color	Item No.	Pack. Unit
gray	284-901	25
blue	284-904	25
orange	284-902	25
red	284-903	25
black	284-905	25
yellow	284-906	25
light gray Ⓜ	284-992 ②	25

3-conductor through terminal block		
Color	Item No.	Pack. Unit
gray	284-681	25
blue	284-684	25
orange	284-682	25
light gray Ⓜ	284-993 ②	25

2-conductor ground terminal block		
green-yellow	284-907	25
green-yellow Ⓜ	284-907/999-950 ②	25

3-conductor ground terminal block		
green-yellow	284-687	25
green-yellow Ⓜ	284-687/999-950 ②	25

Accessories; item-specific

End and intermediate plate; 2.5 mm thick			
orange	284-328	100 (25)	
gray	284-325	100 (25)	
light gray	284-330	100 (25)	

Accessories; item-specific

End and intermediate plate; 2.5 mm thick			
orange	284-339	100 (25)	
gray	284-308	100 (25)	
light gray	284-341	100 (25)	

Separator; oversized; 2 mm thick			
orange	284-329	100 (25)	
gray	284-326	100 (25)	
light gray	284-331	100 (25)	

Separator; oversized; 2 mm thick			
orange	284-340	100 (25)	
gray	284-309	100 (25)	
light gray	284-342	100 (25)	

Step-down cover plate; 1 mm thick			
gray	284-357	100 (25)	
orange	284-367	100 (25)	

Step-down cover plate; 1 mm thick			
gray	284-358	100 (25)	
orange	284-368	100 (25)	

Accessories; 282 Series

Appropriate marking systems: WMB/WMB Inline/WFB

Protective warning marker; with black high-voltage symbol; for 5 terminal blocks			
yellow	284-415	50 (25)	

Step-down jumper; insulated; commons 10/6 mm ² (8/10 AWG) down to 4/2.5/1.5 mm ² (12/14/16 AWG); I _N 15 A			
gray	284-414	50 (25)	

Finger guard; touch-proof cover protects unused conductor entries			
yellow	284-400	100 (25)	

Step-down jumper; insulated; commons 10/6 mm ² (8/10 AWG) down to 6/4 mm ² (10/12 AWG); I _N 30 A			
gray	284-413	50 (25)	

Adjacent jumper; insulated; I _N 57 A			
gray	284-402	100 (25)	
yellow-green	284-422	100 (25)	

Test plug adapter; 8.3 mm wide; for 4 mm Ø test plug; for 1.5 ... 10 mm ² terminal blocks			
gray	209-170	50 (25)	

Alternate jumper; insulated; I _N 57 A			
gray	284-409	50 (25)	

B-type test plug module; snaps together; 8 mm wide			
gray	709-310	100 (25)	

B-type spacer plate; snaps together; 2 mm wide			
gray	709-312	100 (25)	

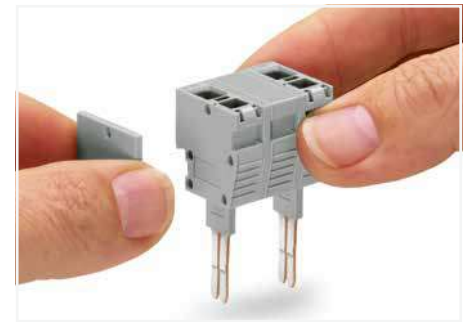

Snapping test plug and spacer modules (each with a spacer plate) together to assemble a multi-pole test plug module (max. 10 poles) for 10 mm terminal block width.



The test plug modules are directly plugged into the jumper contact slot of the current bar (picture shows 284 Series).



Finger guard seals an unused conductor entry.

Through/Ground Conductor and Ex Terminal Block 16 mm²; 283 Series

Technical Data

0.2 ... 16 mm ²	24 ... 6 AWG
800 V / 8 kV / 3 ①	600 V, 65 A ②
I _N 76 A	600 V, 70 A ②
Terminal block width: 12 mm / 0.472 inch	
16 ... 17 mm / 0.63 ... 0.67 inch	

- ① 800 V = rated voltage
8 kV = rated impulse voltage
3 = pollution degree
(see Section 15)
- ② Terminal blocks with an Ex mark are suitable for Ex e II applications.
0.5 ... 16 mm² / 20 ... 6 AWG
550 V; 68 A
63 A jumper
(see Section 15)

Please observe the application notes:
Step-down jumper, page 327
Marking, from page 684

Approvals and corresponding ratings,
visit www.wago.com

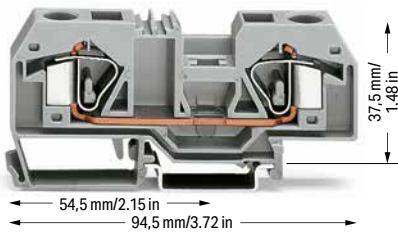

2-conductor through terminal block

Color	Item No.	Pack. Unit
gray	283-901	20
blue	283-904	20
orange	283-902	20
red	283-903	20
black	283-905	20
yellow	283-906	20
light gray ②	283-992 ②	20

2-conductor ground terminal block

green-yellow	283-907	20
green-yellow ②	283-907/999-950 ②	20

Accessories; 283 Series

Appropriate marking systems:
WMB/WMB Inline/WFB

End and intermediate plate; 2.5 mm thick

orange	283-328	50 (25)
gray	283-325	50 (25)
light gray	283-330	50 (25)

Separator; oversized; 2 mm thick

orange	283-329	50 (25)
gray	283-326	50 (25)
light gray	283-331	50 (25)

Protective warning marker; with black high-voltage symbol; for 5 terminal blocks

yellow	283-415	50 (25)
--------	---------	---------

Finger guard; touch-proof cover protects unused conductor entries

yellow	283-400	100 (25)
--------	---------	----------

Adjacent jumper; insulated; I_N 70 A

gray	283-402	50 (25)
yellow-green	283-422	50 (25)

Alternate jumper; insulated; I_N 76 A

gray	283-409	50 (25)
------	---------	---------

Accessories; 283 Series

Appropriate marking systems:
WMB/WMB Inline/WFB

Step-down jumper; insulated; commons 16 mm² (6 AWG) down to 4 mm² (12 AWG); I_N 32 A

gray	283-414	50 (25)
------	---------	---------

Step-down cover plate; 1 mm thick

gray	283-357	100 (25)
orange	283-367	100 (25)

Test plug adapter; 8.3 mm wide; for 4 mm Ø test plug; for 1.5 ... 10 mm² terminal blocks

gray	283-404	25
------	---------	----

Power tap; I_N 24 A; with 500 mm cable; for 16 mm² (283/783 Series) and 35 mm² (285/785 Series) rail-mount terminal blocks

gray	283-407	25
------	---------	----



The markers are not covered by the wiring when marking terminal blocks in center position.



Always push voltage tap (283-407) down into the terminal block until fully inserted!

Through/Ground Conductor and Ex Terminal Block 16 mm²; 283 Series

Technical Data

0.2 ... 16 mm ²	24 ... 6 AWG
800 V / 8 kV / 3 ①	600 V, 65 A ②
I _N 76 A	600 V, 70 A ③
Terminal block width: 12 mm / 0.472 inch	
16 ... 17 mm / 0.63 ... 0.67 inch	

- 800 V = rated voltage
8 kV = rated impulse voltage
3 = pollution degree
(see Section 15)
- Terminal blocks with an Ex mark are suitable for Ex e II applications.
0.5 ... 16 mm² / 20 ... 6 AWG
550 V; 68 A
(see Section 15)

Please observe the application notes:
Marking, from page 684

Approvals and corresponding ratings,
visit www.wago.com

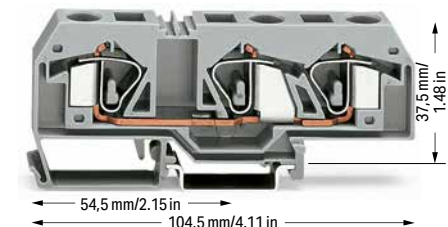

3-conductor through terminal block

Notice: This terminal block cannot be commoned with adjacent jumpers.

Color	Item No.	Pack. Unit
gray	283-671	20
blue	283-674	20
orange	283-672	20
light gray ④	283-998 ②	20

3-conductor ground terminal block

Notice: This terminal block cannot be commoned with adjacent jumpers.

green-yellow	283-677	20
green-yellow ④	283-677/999-950 ②	20



Finger guard seals an unused conductor entry.

Accessories; 283 Series

Appropriate marking systems:
WMB/WMB Inline/WFB

End and intermediate plate; 2.5 mm thick

orange	283-352	50 (25)
gray	283-350	50 (25)
light gray	283-354	50 (25)

Separator; oversized; 2 mm thick

orange	283-353	50 (25)
gray	283-351	50 (25)
light gray	283-355	50 (25)

Protective warning marker; with black high-voltage symbol; for 5 terminal blocks

yellow	283-415	50 (25)
--------	---------	---------

Finger guard; touch-proof cover protects unused conductor entries

yellow	283-400	100 (25)
--------	---------	----------

Through/Ground Conductor and Ex Terminal Block 35 mm²; 285 Series

Technical Data

6 ... 35 mm ²	10 ... 2 AWG
1000 V / 8 kV / 3 ①	600 V, 115 A ②
I _N 125 A	600 V, 120 A ③
Terminal block width: 16 mm / 0.63 inch	
23 mm / 0.91 inch	

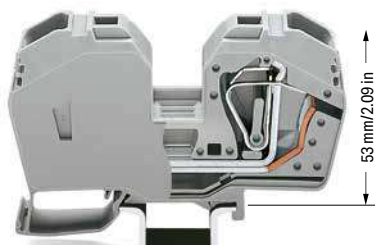

100 mm / 3.94 in

53 mm / 2.09 in

- 1000 V = rated voltage
8 kV = rated impulse voltage
3 = pollution degree
(see Section 15)
- Terminal blocks with an Ex mark are suitable for Ex e II applications.
6 ... 35 mm² / 8 ... 2 AWG
880 V; 85 A
6 ... 25 mm² / 8 ... 4 AWG
for ground conductor terminal blocks
(see Section 15)

Please observe the application notes:
Marking, from page 684

Approvals and corresponding ratings,
visit www.wago.com



Terminating a 35 mm² (2 AWG) conductor –

2-conductor through terminal block; with integrated end plate; only for DIN 35 x 15 rail

Color	Item No.	Pack. Unit
gray	285-635	15
blue	285-634	15
red	285-633	15
black	285-639	15
yellow	285-636	15
light gray ④	285-992 ②	15

2-conductor ground terminal block; with integrated end plate; only for DIN 35 x 15 rail

green-yellow	285-637	15
green-yellow ④	285-637/999-950 ②	15



Protective warning markers inserted into the operating slots

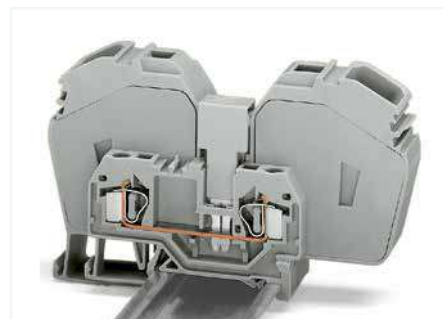

Commoning a 285 Series terminal block (35 mm²/ 2 AWG) with a 281 Series terminal block (4 mm²/ 12 AWG) using a step-down jumper (283-414).

Accessories; 285 Series

Appropriate marking systems:
WMB/WMB Inline/WFB

Adjacent jumper; insulated; I_N 85 A

gray	285-435	50 (25)
------	---------	---------

Step-down jumper; insulated; I_N 90 A

gray	285-430	50 (25)
------	---------	---------

Protective warning marker; with a black high-voltage symbol

yellow	285-416	100 (25)
--------	---------	----------

Finger guard; touch-proof cover protects unused conductor entries

yellow	285-401	100 (25)
--------	---------	----------

Power tap; I_N 24 A; with 500 mm cable; for 16 mm² (283/783 Series) and 35 mm² (285/785 Series) rail-mount terminal blocks

gray	283-407	25
------	---------	----



Finger guard seals an unused conductor entry.

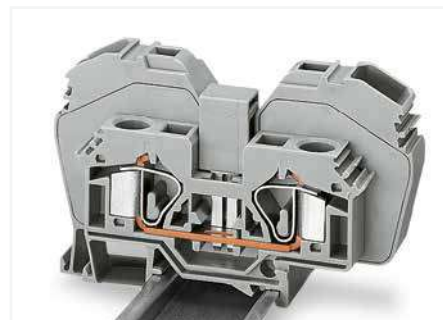

The following 285 Series Through Terminal Blocks can be commoned with 283 Series Through Terminal Blocks: 285-635 or 285-634 with 283-601 or 283-604 (terminal blocks with side marking, visit www.wago.com)
Adjacent jumper required: 285-435

Please note that the nominal current of the adjacent jumper must not exceed 63 A.

6

Distribution Terminal Block; 3 x 10 mm² CAGE CLAMP® Connection and 1 x 35 mm² Screw Clamp Connection

284 Series

Technical Data

0.2 ... 10 mm ² ❶	24 ... 8 AWG
6 ... 35 mm ² ❷	10 ... 2 AWG
800 V / 8 kV / 3 ❸	
I _N 125 A	
Terminal block width: 17.5 mm / 0.689 inch	
12 ... 14 mm / 0.47 ... 0.55 inch	

- ❶ CAGE CLAMP® connection
 - ❷ Screw-type connection
 - ❸ 800 V = rated voltage
8 kV = rated impulse voltage
3 = pollution degree (see Section 15)
 - ❹ Individual arrangement: 125 A
Two jumpers combined in one clamping unit: 100 A
- Please observe the application notes:
Marking, from page 684
- Approvals and corresponding ratings,
visit www.wago.com

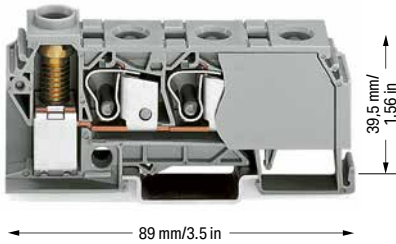

Terminating a 35 mm² (2 AWG) conductor – screw clamp connection, side-entry wiring

Distribution terminal block; with 3 x CAGE CLAMP® connection (10 mm²/8 AWG); 1 x screw clamp connection (35 mm²/2 AWG) and 3.5 Nm screw torque

Color	Item No.	Pack. Unit
○ gray	284-621	15
● blue	284-624	15

Accessories; distribution terminal block

Appropriate marking system:
WMB

Adjacent jumper; insulated; I_N 125 A; for 1 jumper;
I_N 100 A; for 2 jumpers

	gray	284-412 ❹	100 (25)
---	------	-----------	----------

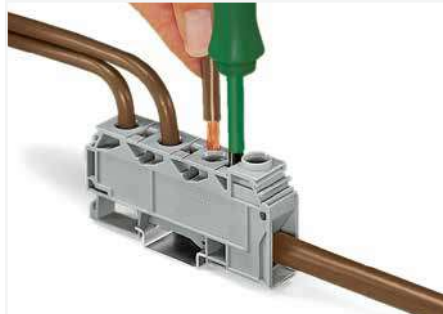

Terminating a 10 mm² (8 AWG) conductor – CAGE CLAMP® connection, front-entry wiring.



Commoning with comb-style jumper bar.

6

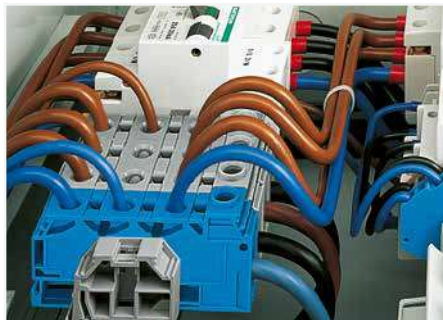

Side-entry distribution terminal block with screw clamp connection (35 mm²/2 AWG) and front-entry CAGE CLAMP® connection (3 x 10 mm²/8 AWG) snaps onto
This terminal block snaps onto DIN-35 rail – it is enclosed on both sides and requires no end or intermediate plate.

When connecting 3 x 10 mm² (8 AWG) conductors on the distribution side, make sure that the nominal current of 125 A is not exceeded.

Step-Down Jumpers; for Front-Entry Through Terminal Blocks up to 16 mm² Installation



Step-down jumper from 10/6 mm² (8/10 AWG) to 4/2.5/1.5 mm² (12/14/16 AWG)
I_N 15 A, Item No. 284-414



Step-down jumper from 10/6 mm² (8/10 AWG) to 6/4 mm² (10/12 AWG)
I_N 30 A, Item No. 284-413



Step-down jumper from 16 mm² (6 AWG) to 4 mm² (12 AWG)
I_N 32 A, Item No. 283-414

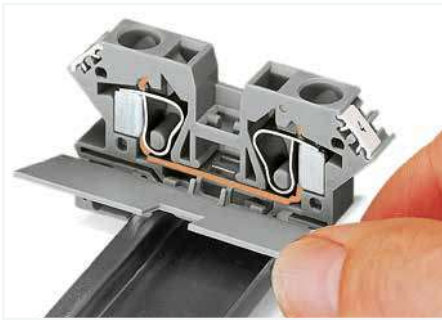

Snapping a cover plate onto open side of terminal block.



A cover plate must also be snapped onto the other side of the larger terminal block.



Commoning terminal blocks of different sizes – step down. Push down the step-down jumper until fully inserted.

Step-down jumpers common terminal blocks of different sizes, without losing a conductor clamping point. This can be beneficial on long conductor runs where voltage drop can be a problem. A large conductor can be easily connected to smaller conductors at the distribution point.

Step-down jumpers are simply pushed down for full insertion, similar to adjacent jumpers. Commoning may be made in either direction using the special thin end plate to cover the open side. Additional through terminal blocks having a smaller cross section may be commoned using adjacent jumpers.

In this case, pay attention that:

- The total current of the outgoing circuits does not exceed the nominal current of the step-down jumper.
- The standard or special thin cover plate is installed on the open side of the larger block.



Note: Jumpers are marked with suitable terminal block sizes for correct installation.

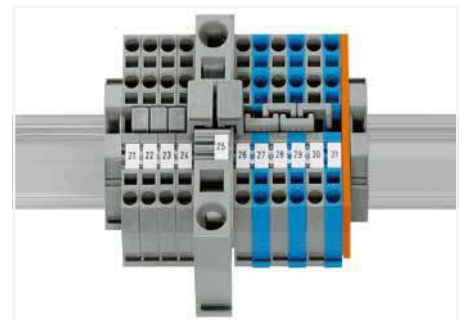

Commoning from 16 mm²/6 AWG (283 Series) to 4 mm²/12 AWG (281 Series) rail-mount terminal blocks via step-down jumpers.

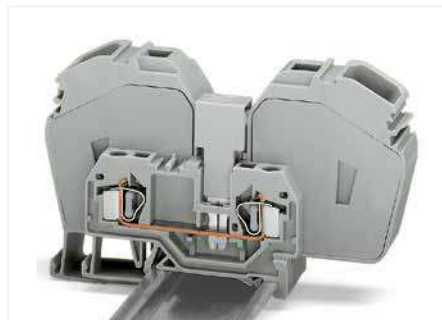

Commoning a 285 Series terminal block (35 mm²/ 2 AWG) with a 281 Series terminal block (4 mm²/ 12 AWG) using a step-down jumper (283-414).

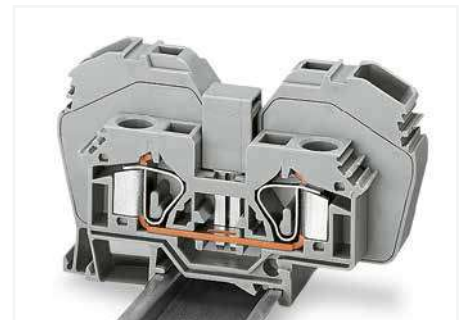

The following 285 Series Through Terminal Blocks can be commoned with 283 Series Through Terminal Blocks: 285-635 or 285-634 with 283-601 or 283-604 (terminal blocks with side marking, visit www.wago.com)
Adjacent jumper required: 285-435

Please note that the nominal current of the adjacent jumper must not exceed 63 A.

Assembly Examples

Step-Down Jumpers; for Front-Entry Through Terminal Blocks

Terminal blocks with side marking, visit www.wago.com



Commoning from 6 mm²/10 AWG (282 Series) to 1.5 mm²/16 AWG (279 Series) rail-mount terminal blocks via step-down jumpers.



Commoning from 10 mm²/8 AWG (284 Series) to 6 mm²/10 AWG (282 Series) rail-mount terminal blocks via step-down jumpers.

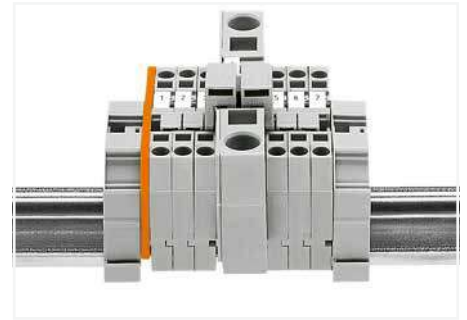

Commoning from 16 mm²/6 AWG (283 Series) to 4 mm²/12 AWG (281 Series) rail-mount terminal blocks via step-down jumpers.

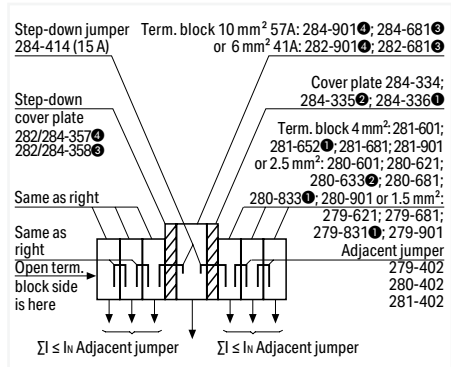

Assembly example: Commoning from 10/6 mm² (8/10 AWG) to 4/2.5/1.5 mm² (12/14/16 AWG) rail-mount terminal blocks via step-down jumper (284-414).

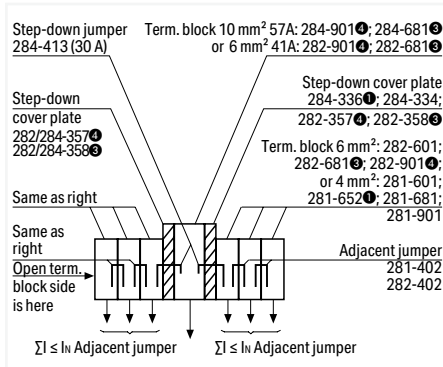

Assembly example: Commoning from 10/6 mm² (8/10 AWG) to 6 mm² (10 AWG) rail-mount terminal blocks via step-down jumper (284-413).

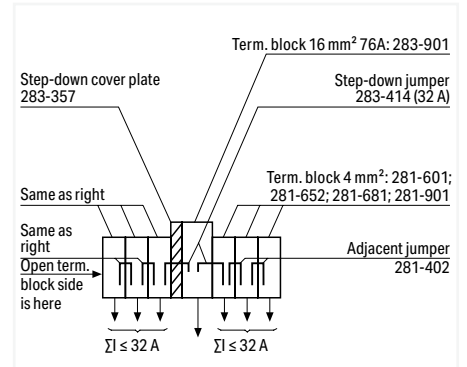

Assembly example: Commoning from 16 mm²/6 AWG to 4 mm²/12 AWG rail-mount terminal blocks via step-down jumper (283-414).

6



Commoning from 6 mm²/10 AWG (282 Series) to 1.5 mm²/16 AWG (279 Series) rail-mount terminal blocks via step-down jumpers.



Commoning from 10 mm²/8 AWG (284 Series) to 6 mm²/10 AWG (282 Series) rail-mount terminal blocks via step-down jumpers.



Commoning from 16 mm²/6 AWG (283 Series) to 4 mm²/12 AWG (281 Series) rail-mount terminal blocks via step-down jumpers.

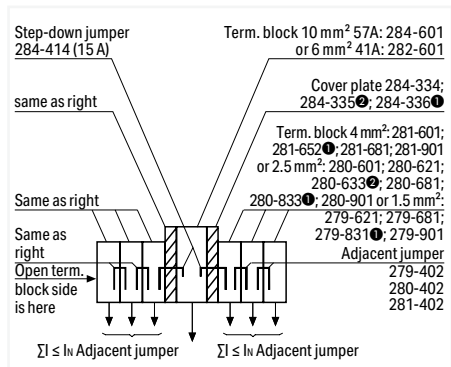

Assembly example: Commoning from 10/6 mm² (8/10 AWG) to 4/2.5/1.5 mm² (12/14/16 AWG) rail-mount terminal blocks via step-down jumper (284-414).

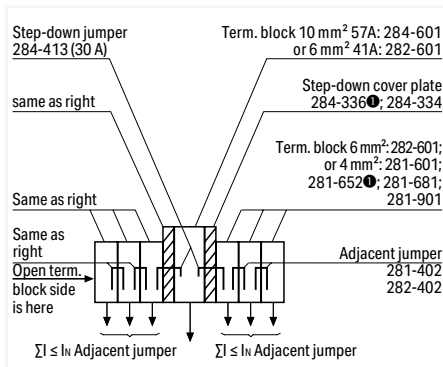

Assembly example: Commoning from 10/6 mm² (8/10 AWG) to 6 mm² (10 AWG) rail-mount terminal blocks via step-down jumper (284-413).

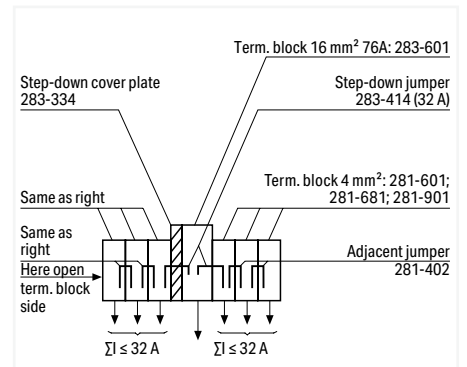

Assembly example: Commoning from 16 mm²/6 AWG to 4 mm²/12 AWG rail-mount terminal blocks via step-down jumper (283-414).

Double-Deck Terminal Block 1.5 mm²; 279 Series

Technical Data

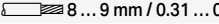
0.08 ... 1.5 mm² | 28 ... 16 AWG
 500 V / 6 kV / 3 
 I_N 18 A
 Terminal block width: 4 mm / 0.157 inch
 8 ... 9 mm / 0.31 ... 0.35 inch

Technical Data

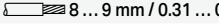
0.08 ... 1.5 mm² | 28 ... 16 AWG
 500 V / 6 kV / 3 
 I_N 18 A
 Terminal block width: 4 mm / 0.157 inch
 8 ... 9 mm / 0.31 ... 0.35 inch

Technical Data

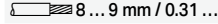
0.08 ... 1.5 mm² | 28 ... 16 AWG
 500 V / 6 kV / 3 
 I_N 18 A
 Terminal block width: 4 mm / 0.157 inch
 8 ... 9 mm / 0.31 ... 0.35 inch

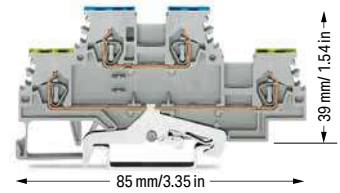
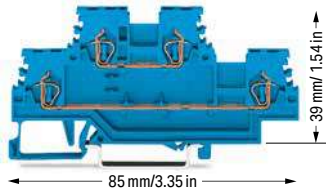
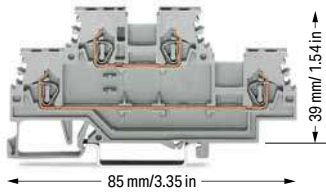

Double-deck terminal block; through/through terminal block; gray

	Item No.	Pack. Unit
<input type="radio"/> L/L	279-501	50
<input type="radio"/> N/L	279-512	50
<input type="radio"/> L/N	279-513	50

Double-deck terminal block; through/through terminal block; blue

	Item No.	Pack. Unit
<input checked="" type="radio"/> N/N	279-504 	50

Double-deck terminal block; ground conductor/through terminal block; gray

	Item No.	Pack. Unit
<input type="radio"/> PE/N	279-517	50
<input type="radio"/> PE/L	279-527	50

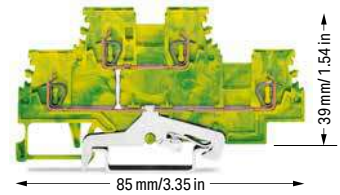
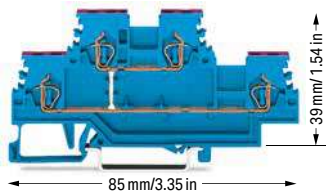
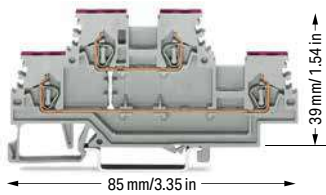

Double-deck terminal block; 4-conductor through terminal block; internally commoned; violet conductor entry; gray

	Item No.	Pack. Unit
<input type="radio"/> L	279-508	50

Double-deck terminal block; 4-conductor through terminal block; internally commoned; violet conductor entry; blue

	Item No.	Pack. Unit
<input checked="" type="radio"/> N	279-509 	50

Double-deck terminal block; 4-conductor ground terminal block; internally commoned; green-yellow

	Item No.	Pack. Unit
<input checked="" type="radio"/> PE	279-507	50

6

- ❶ 500 V = rated voltage
6 kV = rated impulse voltage
3 = pollution degree
(see Section 15)
 - ❷ Terminal blocks with a blue insulated housing are suitable for Ex i applications.
- Please observe the application notes:
Insulation stop, page 425
Comb-style jumper bar, page 426
Marking, from page 684
- Approvals and corresponding ratings, visit www.wago.com

Accessories; 279 Series
Appropriate marking systems:
WMB/WMB Inline/WFB

End and intermediate plate; 2 mm thick

	orange	279-519	200 (25)
	gray	279-518	

Insulation stop; 0.08 ... 0.2 mm² "s" (0.14 mm² "f-st"); 5 pcs/strip

	white	279-470	200 (25)
---	-------	---------	----------

Insulation stop; 0.25 mm²; 5 pcs/strip

	dark gray	279-471	200 (25)
--	-----------	---------	----------

Protective warning marker; with black high-voltage symbol; for 5 terminal blocks

	yellow	279-415	100 (25)
---	--------	---------	----------

Adjacent jumper; insulated; I_N 15 A

	gray	279-402	200 (25)
	yellow-green	279-422	200 (25)

Alternate jumper; insulated; I_N 15 A

	gray	279-409	100 (25)
---	------	---------	----------

Comb-style jumper bar; insulated; I_N = I_N of terminal block

	2-way	279-482	200 (25)
	3-way	279-483	200 (25)

Comb-style jumper bar; insulated; I_N = I_N of terminal block

	10-way	279-490	50 (25)
---	--------	---------	---------

Alternate comb-style jumper bar; insulated; I_N = I_N of terminal block

	2-way	279-492	200 (25)
---	-------	---------	----------

Operating tool; insulated

	2-way	279-432	1
	3-way	279-433	1

Operating tool; insulated

	10-way	279-440	1
---	--------	---------	---

Accessories; 279 Series

Appropriate marking systems:
WMB/WMB Inline/Marking Strips

Double-deck marker carrier

	gray	279-529	50 (25)
---	------	---------	---------

WMB Inline; plain; 2,000 WMB markers (4 mm)/reel; stretchable 4 ... 4.2 mm

	white	2009-114	1
---	-------	----------	---

WMB marking card; white; 10 strips with 10 markers/card; stretchable 4 ... 4.2 mm

	plain	793-4501	5
---	-------	----------	---

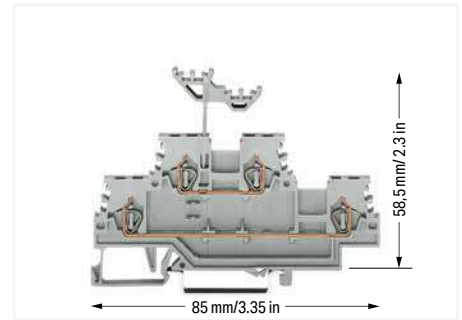

Double-deck marker carrier
(height including marker carrier)

Double- and Triple-Deck Terminal Blocks 280 and 281 Series Description and Installation

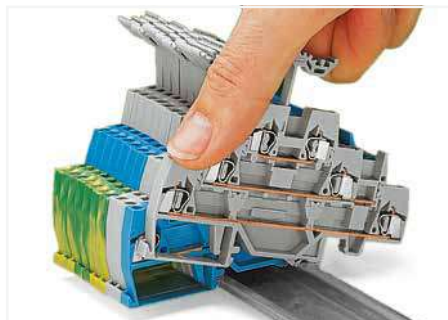

Snapping a terminal block onto the DIN-rail.



Removing a terminal block from the assembly.

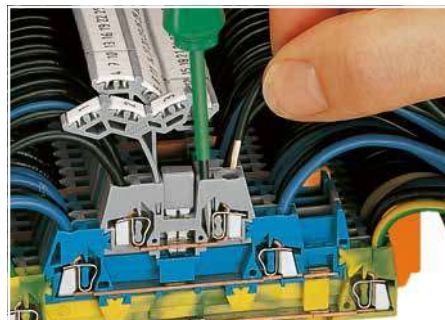

CAGE CLAMP® connection
Inserting a conductor.
With ferruled conductors, it is necessary to use a terminal block one size smaller than the conductor's nominal cross section.

6



Commoning using an adjacent jumper (280-402).
push jumpers down until fully inserted.



Combining vertical and adjacent jumpers.

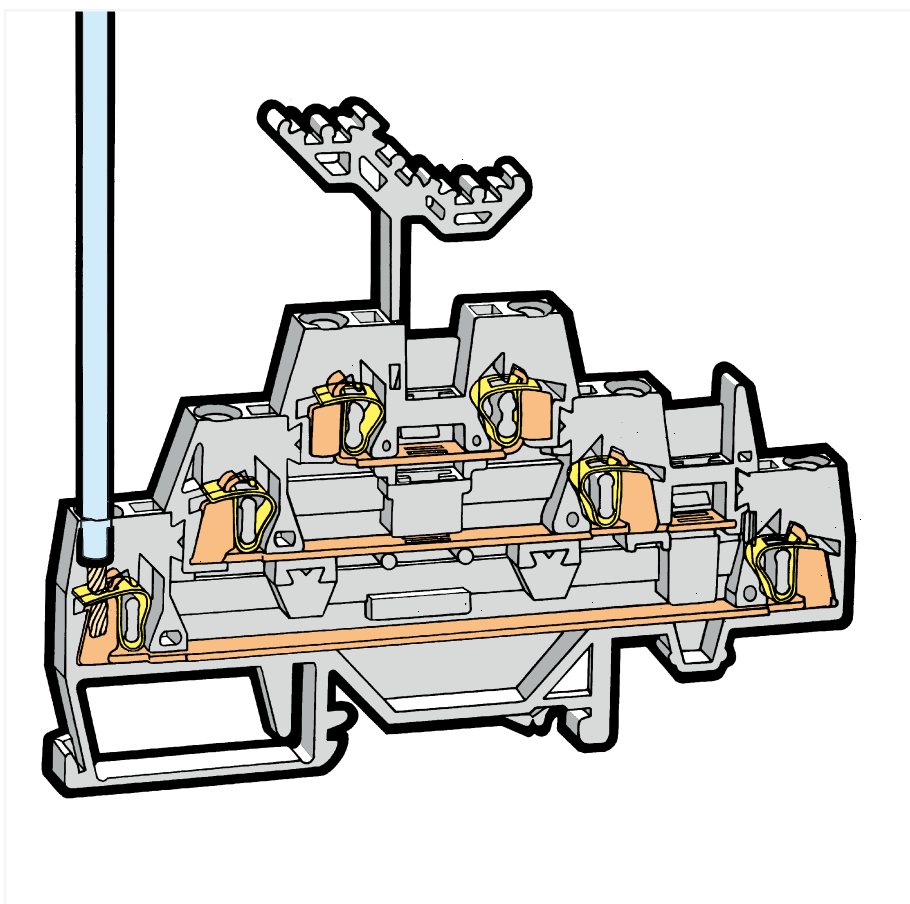

Labeling via WMB Multi Marking System.

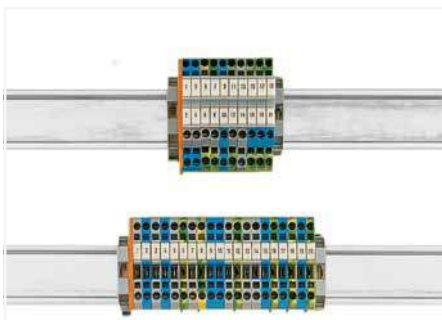

Use 50 % less rail space with double-deck terminal blocks.

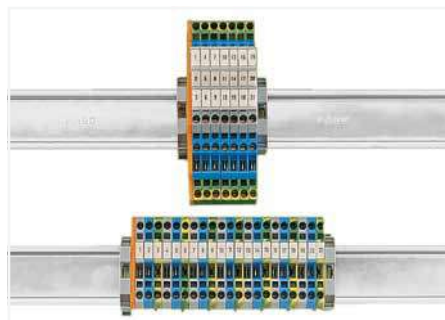

Use 67 % less rail space with triple-deck terminal blocks.



CAGE CLAMP® terminates the following copper conductors:
solid "s"



stranded "st"



fine-stranded "f-st",
also with tinned
single strands

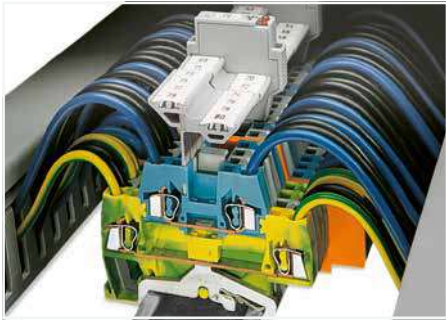

Example of a mixed assembly with double-deck terminal blocks. The 280 Series Double-Deck Terminal Blocks are available with decks of same or different color according to their function. This is an additional visual aid during wiring, service or maintenance.

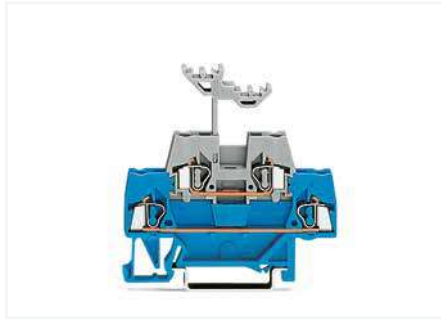

Double-deck terminal blocks accommodate two circuits of different potentials on two decks; different circuits can be differentiated by color coding either deck (280 Series). The lower deck is wider than the upper for ease of wiring.

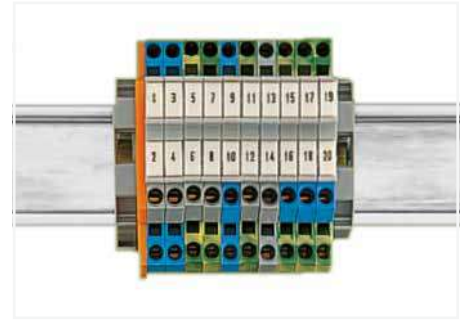

With a terminal block width of just 5 mm, an effective width of just 2.5 mm for terminal blocks of same or different potentials can be realized for conductors ranging 0.08 mm² ... 2.5 mm² (28 ... 14 AWG).

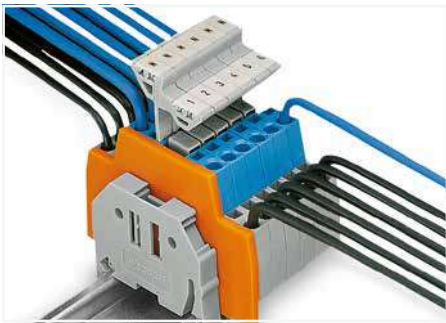

Double-deck terminal blocks used as control conductor terminal blocks (e.g., for magnetic valves) with the upper deck commoned.

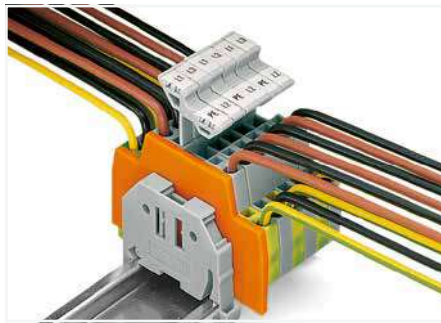

Double-deck terminal blocks used for connecting a three-phase motor.

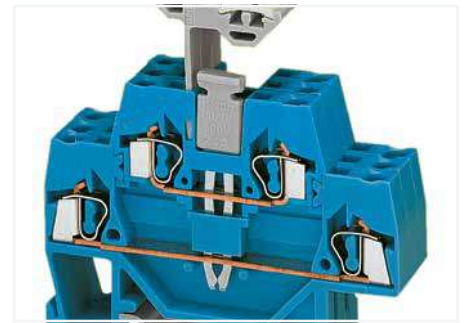

Commoning with a vertical jumper (281-421). Push vertical jumper down until fully inserted.

6

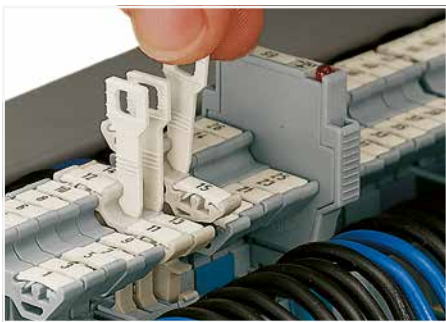

Pulling the disconnect tab.

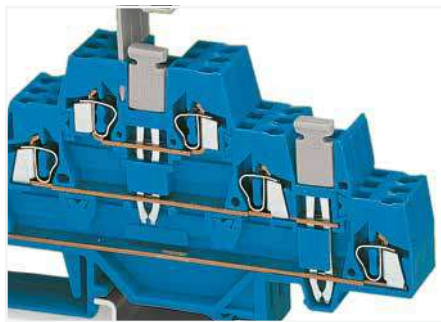

A vertical jumper allows commoning of the upper and lower levels, providing a 6-conductor feedthrough terminal block in one housing. Two adjacent triple-deck terminal blocks may be commoned together on the same level using a push-in adjacent jumper.

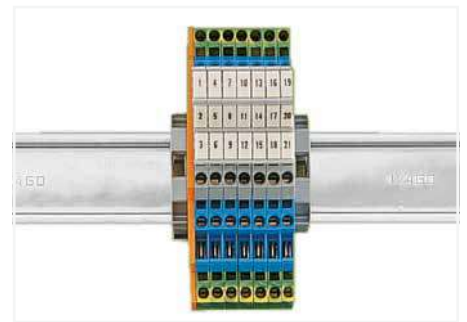

Double-deck (triple-deck) terminal blocks accommodate two (three) circuits of different potentials on two (three) decks; different circuits can be differentiated by color coding either deck (280 Series). The lower deck is wider than the upper for ease of wiring.



fine-stranded, tip-bonded



fine-stranded, with ferrule (gastight crimped)



fine-stranded, with pin terminal (gastight crimped)

Double-Deck Terminal Block

2.5 mm²; 280 Series

Technical Data

0.08 ... 2.5 mm ²	28 ... 12 AWG*
500 V / 6 kV / 3 ①	300 V, 15 A ②
I _N 20 A	300 V, 20 A ③
Terminal block width: 5 mm / 0.197 inch	
8 ... 9 mm / 0.31 ... 0.35 inch	

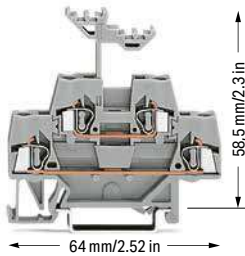

Double-deck terminal block; through/through terminal block

Color	Item No.	Pack. Unit
○ gray	280-519	50
● blue	280-529 ②	50

Other terminal blocks with the same profile:

Diode	280-940/281-410	Page 370
LED	280-943/281-434	Page 370

Accessories; item-specific

End and intermediate plate; 2.5 mm thick

	orange	280-341	100 (25)
	gray	280-340	100 (25)

Intermediate plate; 1.1 mm thick

	orange	280-366	100 (25)
---	--------	---------	----------

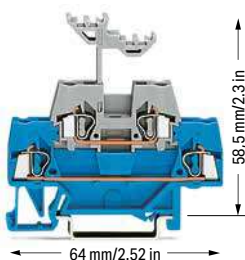

Double-deck terminal block; through/through terminal block

Color	Item No.	Pack. Unit
blue/gray	280-523	50
gray/blue	280-533	50

Accessories; item-specific

End and intermediate plate; 2.5 mm thick

	orange	280-341	100 (25)
	gray	280-340	100 (25)

Intermediate plate; 1.1 mm thick

	orange	280-366	100 (25)
---	--------	---------	----------

Technical Data

0.08 ... 2.5 mm ²	28 ... 12 AWG*
500 V / 6 kV / 3 ①	300 V, 15 A ②
I _N 20 A	300 V, 20 A ③
Terminal block width: 5 mm / 0.197 inch	
8 ... 9 mm / 0.31 ... 0.35 inch	

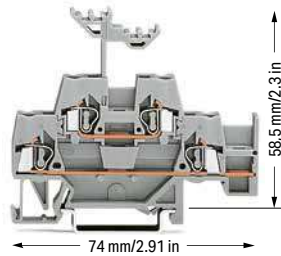

Double-deck terminal block; through/through terminal block; with slot for adjacent jumper

Color	Item No.	Pack. Unit
○ gray	280-520	50
● blue	280-530 ②	50

Accessories; item-specific

End and intermediate plate; 2.5 mm thick

	orange	280-343	100 (25)
	gray	280-342	100 (25)

Intermediate plate; 1.1 mm thick

	orange	280-369	100 (25)
---	--------	---------	----------

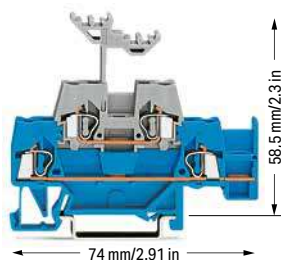

Double-deck terminal block; through/through terminal block; with slot for adjacent jumper

Color	Item No.	Pack. Unit
blue/gray	280-524	50
gray/blue	280-534	50

Accessories; item-specific

End and intermediate plate; 2.5 mm thick

	orange	280-343	100 (25)
	gray	280-342	100 (25)

Intermediate plate; 1.1 mm thick

	orange	280-369	100 (25)
---	--------	---------	----------

Technical Data

0.08 ... 2.5 mm ²	28 ... 12 AWG*
500 V / 6 kV / 3 ①	300 V, 20 A ③
I _N 20 A	300 V, 20 A ③
Terminal block width: 5 mm / 0.197 inch	
8 ... 9 mm / 0.31 ... 0.35 inch	

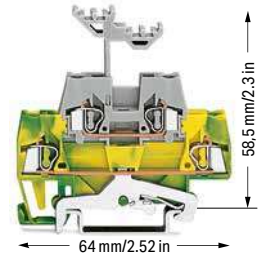

Double-deck terminal block; ground conductor/through terminal block

Color	Item No.	Pack. Unit
green-yellow/gray	280-527	50
green-yellow/blue	280-537	50

Accessories; item-specific

End and intermediate plate; 2.5 mm thick

	orange	280-341	100 (25)
	gray	280-340	100 (25)

Intermediate plate; 1.1 mm thick

	orange	280-366	100 (25)
---	--------	---------	----------

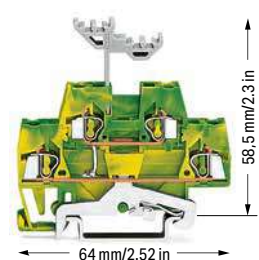

Double-deck terminal block; 4-conductor ground terminal block; internally commoned

Color	Item No.	Pack. Unit
● green-yellow	280-517	50

Accessories; item-specific

End and intermediate plate; 2.5 mm thick

	orange	280-341	100 (25)
	gray	280-340	100 (25)

Intermediate plate; 1.1 mm thick

	orange	280-366	100 (25)
---	--------	---------	----------

6

Technical Data

0.08 ... 2.5 mm ²	28 ... 12 AWG*
400 V / 6 kV / 3 ①	300 V, 15 A ②
I _N 10 A	300 V, 20 A ②
Terminal block width: 5 mm / 0.197 inch	
8 ... 9 mm / 0.31 ... 0.35 inch	

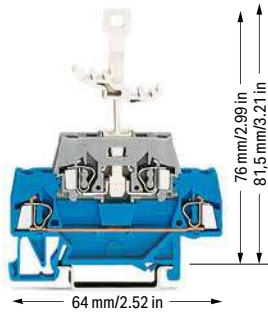

Double-deck terminal block; through/disconnect terminal block

Color	Item No.	Pack. Unit
blue/gray	280-525	50
○ gray/gray	280-521	50

Accessories; item-specific

End and intermediate plate; 2.5 mm thick

	orange	280-341	100 (25)
	gray	280-340	100 (25)

Intermediate plate; 1.1 mm thick

	orange	280-366	100 (25)
--	--------	---------	----------

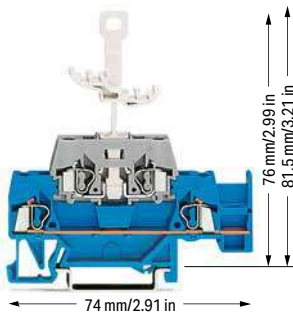

Double-deck terminal block; through/disconnect terminal block; with slot for adjacent jumper

Color	Item No.	Pack. Unit
blue/gray	280-526	50
○ gray/gray	280-522	50

Accessories; item-specific

End and intermediate plate; 2.5 mm thick

	orange	280-343	100 (25)
	gray	280-342	100 (25)

Intermediate plate; 1.1 mm thick

	orange	280-369	100 (25)
--	--------	---------	----------

Technical Data

0.08 ... 2.5 mm ²	28 ... 12 AWG*
500 V / 6 kV / 3 ①	300 V, 15 A ②
I _N 20 A	300 V, 20 A ②
Terminal block width: 5 mm / 0.197 inch	
8 ... 9 mm / 0.31 ... 0.35 inch	

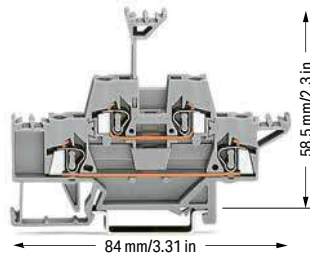

Double-deck terminal block; through/through terminal block; with additional marking options on both terminal block sides

Color	Item No.	Pack. Unit
○ gray	280-513	50

Accessories; item-specific

End and intermediate plate; 2.5 mm thick

	orange	280-341	100 (25)
	gray	280-340	100 (25)

Intermediate plate; 1.1 mm thick

	orange	280-366	100 (25)
--	--------	---------	----------

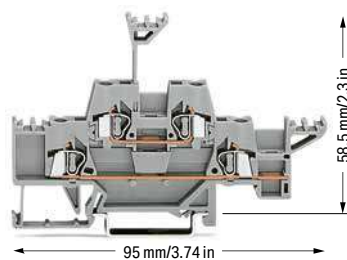

Double-deck terminal block; through/through terminal block; with additional marking options on both terminal block sides; with slot for adjacent jumper

Color	Item No.	Pack. Unit
○ gray	280-543	50

Accessories; item-specific

End and intermediate plate; 2.5 mm thick

	orange	280-343	100 (25)
	gray	280-342	100 (25)

Intermediate plate; 1.1 mm thick

	orange	280-369	100 (25)
--	--------	---------	----------

*12 AWG: THHN, THWN

① 500 V / 400 V = rated voltage
6 kV = rated impulse voltage
3 = pollution degree (see Section 15)

② Terminal blocks with a blue insulated housing are suitable for Ex i applications.

Please observe the application notes:
Insulation stop, page 425
Comb-style jumper bar, page 426
Marking, from page 684

Approvals and corresponding ratings, visit www.wago.com

Accessories; 280 Series

Appropriate marking systems:
WMB/WMB Inline

Insulation stop; 0.08 ... 0.2 mm² "s" (0.14 mm² "f-st"); 5 pcs/strip

	white	280-470	200 (25)
--	-------	---------	----------

Insulation stop; 0.25 ... 0.5 mm²; 5 pcs/strip

	light gray	280-471	200 (25)
--	------------	---------	----------

Insulation stop; 0.75 ... 1 mm²; 5 pcs/strip

	dark gray	280-472	200 (25)
--	-----------	---------	----------

Adjacent jumper; insulated; I_N = I_N terminal block

	gray	280-402	200 (25)
	yellow-green	280-422	200 (25)

Alternate jumper; insulated; I_N = I_N terminal block

	gray	280-409	100 (25)
--	------	---------	----------

Vertical jumper; insulated; I_N 24 A

	gray	281-421	200 (25)
--	------	---------	----------

Comb-style jumper bar; insulated; I_N = I_N of terminal block

	2-way	280-482	200 (25)
	3-way	280-483	200 (25)

Comb-style jumper bar; insulated; I_N = I_N of terminal block

	10-way	280-490	50 (25)
--	--------	---------	---------

Alternate comb-style jumper bar; insulated; I_N = I_N of terminal block

	2-way	280-492	200 (25)
--	-------	---------	----------

Operating tool; insulated

	2-way	280-432	1
	3-way	280-433	1

Operating tool; insulated

	10-way	280-440	1
--	--------	---------	---

Double- and Triple-Deck Carrier Terminal Block for Fuse Plugs 2.5 mm²; 280 Series

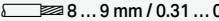
Technical Data	
0.08 ... 2.5 mm ²	28 ... 12 AWG*
400 V / 6 kV / 3 1 2	300 V, 15 A 1 2
I _N 10 A (20 A)	300 V, 20 A 2
Terminal block width: 5 mm / 0.197 inch	
 8 ... 9 mm / 0.31 ... 0.35 inch	

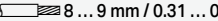
Technical Data	
0.08 ... 2.5 mm ²	28 ... 12 AWG*
400 V / 6 kV / 3 1 2	300 V, 15 A 1 2
I _N 10 A (20 A)	300 V, 20 A 2
Terminal block width: 5 mm / 0.197 inch	
 8 ... 9 mm / 0.31 ... 0.35 inch	

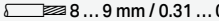
Technical Data	
0.08 ... 2.5 mm ²	28 ... 12 AWG*
400 V / 6 kV / 3 1 2	300 V, 15 A 1 2
I _N 10 A (10 A)	
Terminal block width: 5 mm / 0.197 inch	
 8 ... 9 mm / 0.31 ... 0.35 inch	

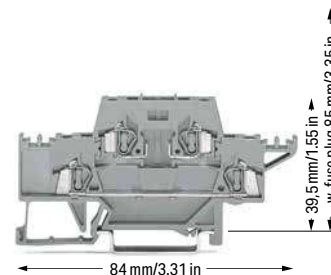
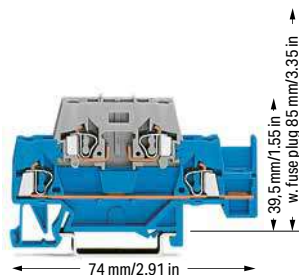
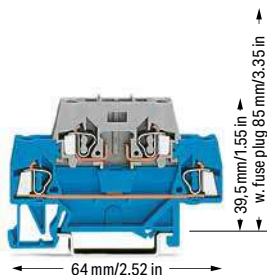

Double-deck terminal block; through/carrier terminal block for fuse plugs

Color	Item No.	Pack. Unit
blue/gray	280-531	50
○ gray/gray	280-514	50

Double-deck terminal block; through/carrier terminal block for fuse plugs; with slot for adjacent jumper

Color	Item No.	Pack. Unit
blue/gray	280-532	50
○ gray/gray	280-891	50

Double-deck terminal block; through/carrier terminal block for fuse plugs

Color	Item No.	Pack. Unit
○ gray/gray	280-528	50

Accessories; item-specific
End and intermediate plate; 2.5 mm thick

	orange	280-341	100 (25)
	gray	280-340	100 (25)

Accessories; item-specific
End and intermediate plate; 2.5 mm thick

	orange	280-343	100 (25)
	gray	280-342	100 (25)

Accessories; item-specific
End and intermediate plate; 2.5 mm thick

	orange	280-341	100 (25)
	gray	280-340	100 (25)

Intermediate plate; 1.1 mm thick

	orange	280-366	100 (25)
---	--------	---------	----------

Intermediate plate; 1.1 mm thick

	orange	280-369	100 (25)
---	--------	---------	----------

Intermediate plate; 1.1 mm thick

	orange	280-366	100 (25)
---	--------	---------	----------

Adjacent jumper; insulated; I_N = I_N terminal block

	gray	280-402	200 (25)
---	------	---------	----------

Alternate jumper; insulated; I_N = I_N terminal block

	gray	280-409	100 (25)
---	------	---------	----------

Accessories

Appropriate marking systems: 4 mm wide WSB for plug and WMB terminal block

Insulation stop; 0.08 ... 0.2 mm² "s" (0.14 mm² "f-st"); 5 pcs/strip

	white	280-470	200 (25)
---	-------	---------	----------

Insulation stop; 0.25 ... 0.5 mm²; 5 pcs/strip

	light gray	280-471	200 (25)
---	------------	---------	----------

Insulation stop; 0.75 ... 1 mm²; 5 pcs/strip

	dark gray	280-472	200 (25)
---	-----------	---------	----------

Fuse plug with pull-tab; 6 mm wide

		281-511	50
---	--	---------	----

Fuse plug with pull-tab; 6 mm wide

		281-512	50
---	--	---------	----

Fuse plug with pull-tab; 24 VAC/DC; with LED; 6 mm wide

		281-512/281-501	50
---	--	-----------------	----

Comb-style jumper bar; insulated; I_N = I_N of terminal block

	2-way	280-482	200 (25)
	3-way	280-483	200 (25)

Alternate comb-style jumper bar; insulated; I_N = I_N of terminal block

	2-way	280-492	200 (25)
---	-------	---------	----------

Operating tool; insulated

	2-way	280-432	1
	3-way	280-433	1

WMB marking card; white; 10 strips with 10 markers/card; 4 ... 4.2 mm stretchable

	plain	793-4501	5
---	-------	----------	---

WMB marking card; white; 10 strips with 10 markers/card; 4 ... 4.2 mm stretchable

	F1, ..., F10 (10x)	794-4615	5
	F11, ..., F20 (10x)	794-4616	5
	F21, ..., F30 (10x)	794-4617	5
	F31, ..., F40 (10x)	794-4618	5
	F41, ..., F50 (10x)	794-4619	5

Technical Data

0.08 ... 2.5 mm ²	28 ... 12 AWG*
400 V / 6 kV / 3 ①②	300 V, 15 A ③
I _N 20 A (20 A)	300 V, 20 A ④
Terminal block width: 5 mm / 0.197 inch	
8 ... 9 mm / 0.31 ... 0.35 inch	

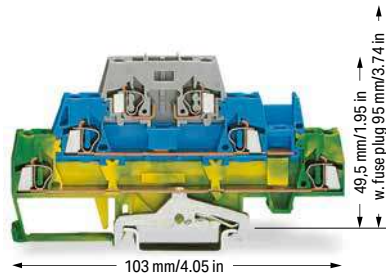

Triple-deck terminal block; ground conductor/through/carrier terminal block for fuse plugs

Color	Item No.	Pack. Unit
green-yellow/blue/gray	280-510	50

Accessories; item-specific

End and intermediate plate; 2.5 mm thick

	orange	280-304	50 (25)
	gray	280-303	50 (25)

Intermediate plate; 1.1 mm thick

	orange	280-336	50 (25)
--	--------	---------	---------

Adjacent jumper; insulated; I_N = I_N terminal block

	gray	280-402	200 (25)
--	------	---------	----------

Alternate jumper; insulated; I_N = I_N terminal block

	gray	280-409	100 (25)
--	------	---------	----------

Vertical jumper; insulated; I_N 24 A

	gray	281-421	200 (25)
--	------	---------	----------

WSB marking card; white, 10 strips with 10 markers/card; 4 mm wide WSB markers

	plain	209-701	5
--	-------	---------	---

WSB marking card; plain; 10 strips with 10 markers/card; 4 mm wide WSB markers

	yellow	209-701/000-002	5
	red	209-701/000-005	5
	blue	209-701/000-006	5
	gray	209-701/000-007	5
	orange	209-701/000-012	5
	light green	209-701/000-017	5
	green	209-701/000-023	5
	violet	209-701/000-024	5

Technical Data

0.08 ... 2.5 mm ²	28 ... 12 AWG*
400 V / 6 kV / 3 ①②	300 V, 15 A ③
I _N 20 A (20 A)	300 V, 20 A ④
Terminal block width: 5 mm / 0.197 inch	
8 ... 9 mm / 0.31 ... 0.35 inch	

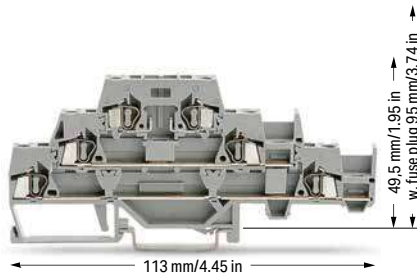

Triple-deck terminal block; through/through/carrier terminal block for fuse plugs; with slot for adjacent jumper on lower level

Color	Item No.	Pack. Unit
gray/gray/gray	280-889	50

Accessories; item-specific

End and intermediate plate; 2.5 mm thick

	orange	280-306	50 (25)
	gray	280-305	50 (25)

Intermediate plate; 1.1 mm thick

	orange	280-339	50 (25)
--	--------	---------	---------

Adjacent jumper; insulated; I_N = I_N terminal block

	gray	280-402	200 (25)
--	------	---------	----------

Alternate jumper; insulated; I_N = I_N terminal block

	gray	280-409	100 (25)
--	------	---------	----------

Vertical jumper; insulated; I_N 24 A

	gray	281-421	200 (25)
--	------	---------	----------

WSB marking card; for fuse plugs (281-5...); white; 4 mm wide WSB markers

	F1, ..., F10 (10x)	209-787	5
	F11, ..., F20 (10x)	209-700/209-124	5
	F21, ..., F30 (10x)	209-700/209-125	5
	F31, ..., F40 (10x)	209-700/209-126	5
	F41, ..., F50 (10x)	209-700/209-127	5

*12 AWG: THHN, THWN

- 500 V / 400 V = rated voltage
6 kV = rated impulse voltage
3 = pollution degree
(see Section 15)

- Electrical ratings are given by the fuse or LED nominal voltage (see page 387).

Please observe the application notes:
Insulation stop, page 425
Comb-style jumper bar, page 426
Marking, from page 684

Approvals and corresponding ratings, visit www.wago.com

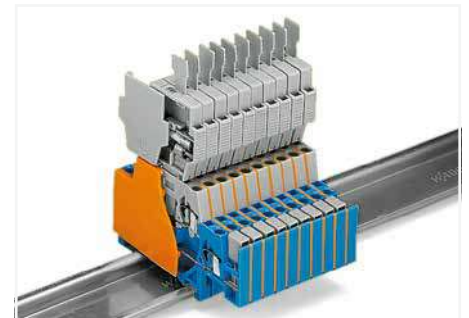

When double-deck terminal blocks are used with a fuse plug (6 mm wide) in the receptacle (top) level, the extra width can be compensated for the 280 Series (5 mm wide) via an intermediate plate (1.1 mm thick). If required, this special intermediate plate still allows commoning on the lower level via push-in adjacent jumpers (280-402).

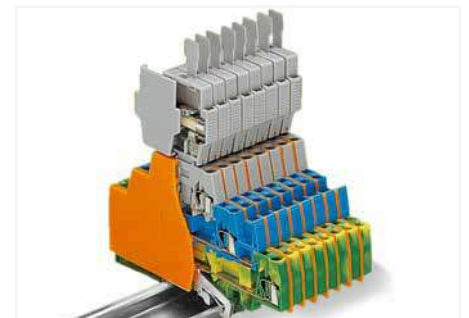

When triple-deck terminal blocks are used with a fuse plug (6 mm wide) in the receptacle (top) level, the extra width can be compensated for the 280 Series (5 mm wide) via an intermediate plate (1.1 mm thick).

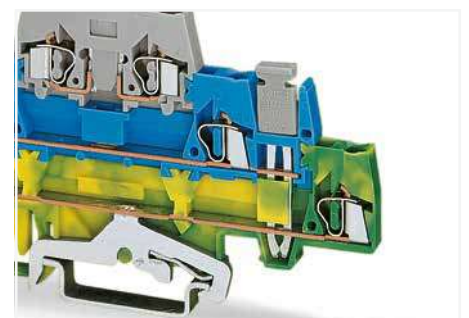

Grounding to DIN-rail:
Connecting N-level to ground level via vertical jumper.

Double-Deck Terminal Block

4 mm²; 281 Series

Technical Data

0.08 ... 4 mm ²	28 ... 12 AWG
500 V / 6 kV / 3 ①	600 V, 20 A ②
I _N 26 A	600 V, 25 A ②
Terminal block width: 6 mm / 0.236 inch	
9 ... 10 mm / 0.35 ... 0.39 inch	

Technical Data

0.08 ... 4 mm ²	28 ... 12 AWG
500 V / 6 kV / 3 ①	600 V, 20 A ②
I _N 26 A	600 V, 25 A ②
Terminal block width: 6 mm / 0.236 inch	
9 ... 10 mm / 0.35 ... 0.39 inch	

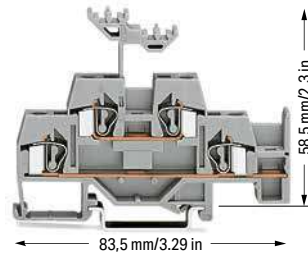
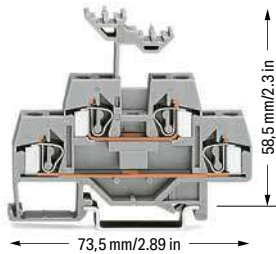

Double-deck terminal block; through/through terminal block

Color	Item No.	Pack. Unit
○ gray	281-619	50
● blue	281-629 ②	50

Double-deck terminal block; through/through terminal block; with slot for adjacent jumper

Color	Item No.	Pack. Unit
○ gray	281-620	50
● blue	281-630 ②	50

Other terminal blocks with the same profile:

Diode	281-633/281-410	Page 414
LED	281-634/281-434	Page 414

Accessories; item-specific

End and intermediate plate; 2.5 mm thick

	orange	281-341	100 (25)
	gray	281-340	100 (25)

Accessories; item-specific

End and intermediate plate; 2.5 mm thick

	orange	281-343	100 (25)
	gray	281-342	100 (25)

Accessories; 281 Series

Appropriate marking systems: WMB/WMB Inline

Insulation stop; 0.08 ... 0.2 mm² "s" (0.14 mm² "f-st"); 5 pcs/strip

	white	281-470	200 (25)
--	-------	---------	----------

Alternate comb-style jumper bar; insulated; I_N = I_N of terminal block

	2-way	281-492	100 (25)
--	-------	---------	----------

Insulation stop; 0.25 ... 0.5 mm²; 5 pcs/strip

	light gray	281-471	200 (25)
--	------------	---------	----------

Operating tool; insulated

	2-way	280-432	1
	3-way	280-433	1
	5-way	281-440	1

Insulation stop; 0.75 ... 1.5 mm²; 5 pcs/strip

	dark gray	281-472	200 (25)
--	-----------	---------	----------

Adjacent jumper; insulated; I_N = I_N terminal block

	gray	281-402	200 (25)
	yellow-green	281-422	200 (25)

Alternate jumper; insulated; I_N = I_N terminal block

	gray	281-409	100 (25)
--	------	---------	----------

Vertical jumper; insulated; I_N 24 A

	gray	281-421	200 (25)
--	------	---------	----------

Comb-style jumper bar; insulated; I_N = I_N of terminal block

	2-way	281-482	100 (25)
	3-way	281-483	100 (25)
	5-way	281-485	100 (25)
	10-way	281-490	50 (25)

- ① 500 V = rated voltage
6 kV = rated impulse voltage
3 = pollution degree
(see Section 15)

- ② Terminal blocks with a blue insulated housing are suitable for Ex i applications.

Please observe the application notes:
Insulation stop, page 425
Comb-style jumper bar, page 426
Marking, from page 684

Approvals and corresponding ratings,
visit www.wago.com



The flexible marker carrier, which is placed above the wiring level, can be pushed aside during wiring or commoning. The carrier has two staggered levels for WMB markers that perfectly align with the terminal block decks.

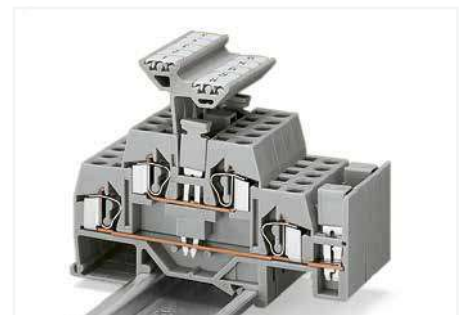

A vertical jumper allows commoning of upper and lower level, giving a 4-conductor commoned through terminal block in one housing. Two adjacent terminals may be commoned together on the same level using a push-in adjacent jumper.

6

6

Triple-Deck Terminal Block 2.5 mm²; 280 Series

Technical Data

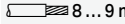
0.08 ... 2.5 mm ²	28 ... 12 AWG*
500 V / 6 kV / 3 Ⓢ	300 V, 15 A VA
I _N 20 A	300 V, 20 A Ⓢ
Terminal block width: 5 mm / 0.197 inch	
 8 ... 9 mm / 0.31 ... 0.35 inch	

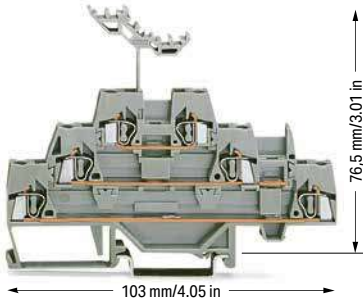

Triple-deck terminal block; through/through/through terminal block

Color	Item No.	Pack. Unit
○ gray	280-549	40
● blue	280-551	40

Accessories; item-specific

End and intermediate plate; 2.5 mm thick

	orange	280-304	50 (25)
	gray	280-303	50 (25)

Intermediate plate; 1.1 mm thick

	orange	280-336	50 (25)
--	--------	---------	---------

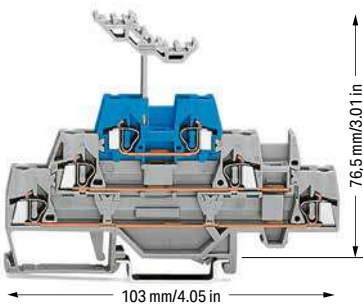

Triple-deck terminal block; through/through/through terminal block

Color	Item No.	Pack. Unit
gray/gray/blue	280-552	40

Accessories; item-specific

End and intermediate plate; 2.5 mm thick

	orange	280-304	50 (25)
	gray	280-303	50 (25)

Intermediate plate; 1.1 mm thick

	orange	280-336	50 (25)
--	--------	---------	---------

Technical Data

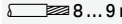
0.08 ... 2.5 mm ²	28 ... 12 AWG*
500 V / 6 kV / 3 Ⓢ	300 V, 15 A VA
I _N 20 A	300 V, 20 A Ⓢ
Terminal block width: 5 mm / 0.197 inch	
 8 ... 9 mm / 0.31 ... 0.35 inch	

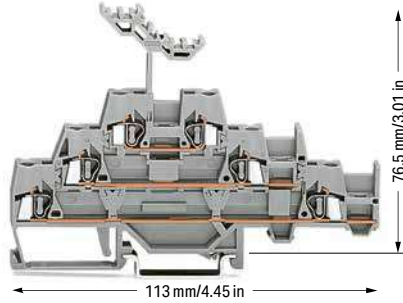

Triple-deck terminal block; through/through/through terminal block; with slot for adjacent jumper on lower level

Color	Item No.	Pack. Unit
○ gray	280-550	40

Accessories; item-specific

End and intermediate plate; 2.5 mm thick

	orange	280-306	50 (25)
	gray	280-305	50 (25)

Intermediate plate; 1.1 mm thick

	orange	280-339	50 (25)
---	--------	---------	---------

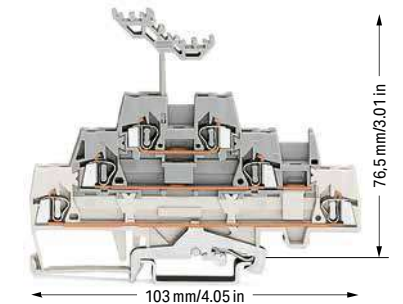

Triple-deck terminal block; shield conductor/through/through terminal block

Color	Item No.	Pack. Unit
white/gray/gray	280-548	40
white/blue/gray	280-558	40

Accessories; item-specific

End and intermediate plate; 2.5 mm thick

	orange	280-304	50 (25)
	gray	280-303	50 (25)

Intermediate plate; 1.1 mm thick

	orange	280-336	50 (25)
---	--------	---------	---------

Technical Data

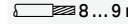
0.08 ... 2.5 mm ²	28 ... 12 AWG*
500 V / 6 kV / 3 Ⓢ	300 V, 20 A Ⓢ
I _N 20 A	300 V, 20 A Ⓢ
Terminal block width: 5 mm / 0.197 inch	
 8 ... 9 mm / 0.31 ... 0.35 inch	

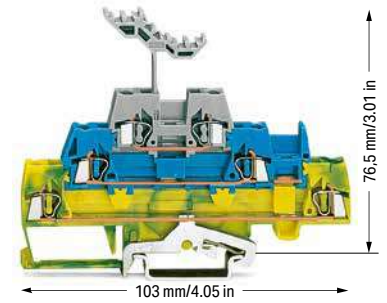

Triple-deck terminal block; ground conductor/through/through terminal block

Color	Item No.	Pack. Unit
green-yellow/blue/gray	280-547	40
green-yellow/gray/gray	280-557	40

Accessories; item-specific

End and intermediate plate; 2.5 mm thick

	orange	280-304	50 (25)
	gray	280-303	50 (25)

Intermediate plate; 1.1 mm thick

	orange	280-336	50 (25)
---	--------	---------	---------

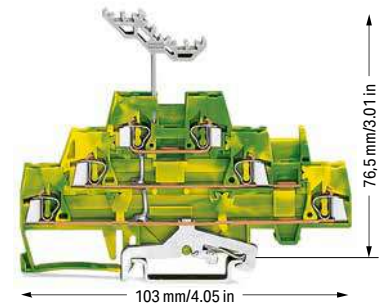

Triple-deck terminal block; 6-conductor ground terminal block; internally commoned

Color	Item No.	Pack. Unit
● green-yellow	280-597	40

Accessories; item-specific

End and intermediate plate; 2.5 mm thick

	orange	280-304	50 (25)
	gray	280-303	50 (25)

Intermediate plate; 1.1 mm thick

	orange	280-336	50 (25)
---	--------	---------	---------

6

*12 AWG: THHN, THWN

- 500 V = rated voltage
- 6 kV = rated impulse voltage
- 3 = pollution degree (see Section 15)

Please observe the application notes:
 Insulation stop, page 425
 Comb-style jumper bar, page 426
 Marking, from page 684

Approvals and corresponding ratings, visit www.wago.com

Accessories; 280 Series

Appropriate marking systems:
 WMB/WMB Inline

Insulation stop; 0.08 ... 0.2 mm² "s" (0.14 mm² "f-st"); 5 pcs/strip

	white	280-470	200 (25)
---	-------	---------	----------

Insulation stop; 0.25 ... 0.5 mm²; 5 pcs/strip

	light gray	280-471	200 (25)
---	------------	---------	----------

Insulation stop; 0.75 ... 1 mm²; 5 pcs/strip

	dark gray	280-472	200 (25)
---	-----------	---------	----------

Adjacent jumper; insulated; I_N = I_N terminal block

	gray	280-402	200 (25)
	yellow-green	280-422	200 (25)

Alternate jumper; insulated; I_N = I_N terminal block

	gray	280-409	100 (25)
---	------	---------	----------

Vertical jumper; insulated; I_N 24 A

	gray	281-421	200 (25)
---	------	---------	----------

Comb-style jumper bar; insulated; I_N = I_N of terminal block

	2-way	280-482	200 (25)
	3-way	280-483	200 (25)

Comb-style jumper bar; insulated; I_N = I_N of terminal block

	10-way	280-490	50 (25)
---	--------	---------	---------

Alternate comb-style jumper bar; insulated; I_N = I_N of terminal block

	2-way	280-492	200 (25)
---	-------	---------	----------

Operating tool; insulated

	2-way	280-432	1
	3-way	280-433	1

Operating tool; insulated

	10-way	280-440	1
---	--------	---------	---

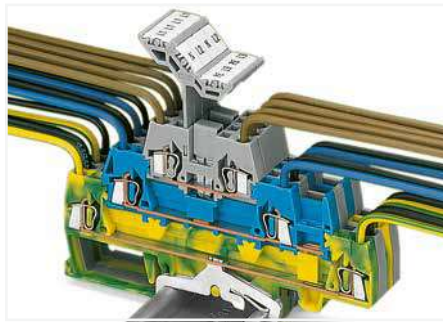

Three-conductor power circuit with additional branch circuit tapping

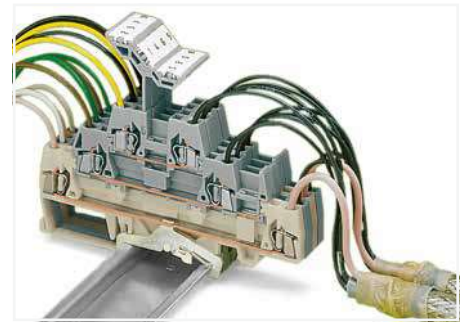

Shielded twisted pair cables

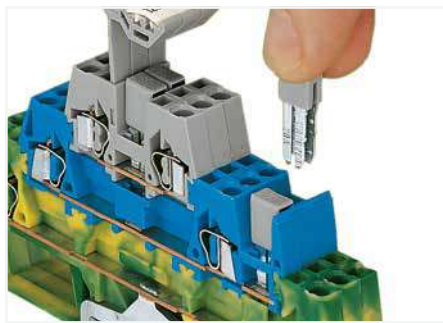

Triple-deck terminal blocks accommodate three circuits of different potentials on three decks; different circuits can be differentiated by color coding either deck (280 Series).

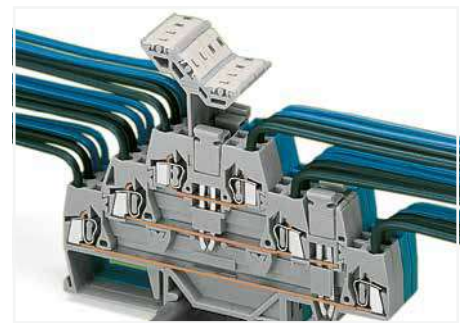

Commoning with vertical and adjacent jumpers.

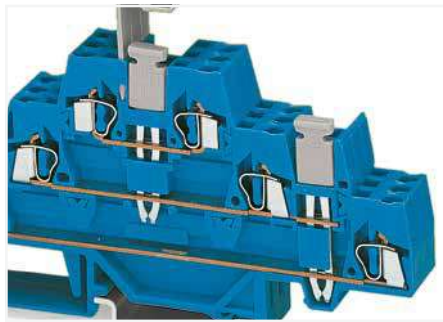

A vertical jumper allows commoning of the upper and lower levels, providing a 6-conductor feedthrough terminal block in one housing. Two adjacent triple-deck terminal blocks may be commoned together on the same level using a push-in adjacent jumper.

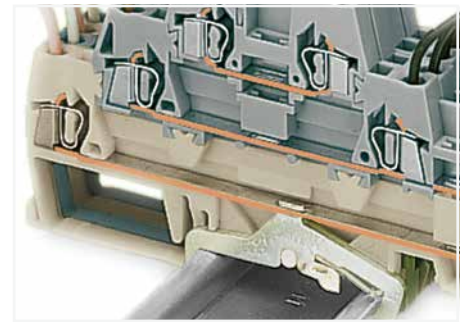

Both ground and shield conductor terminal blocks have a contact foot in the bottom level, automatically establishing direct contact to the DIN-rail or busbar. The flexible marker carrier, which is placed above the wiring level, can be pushed aside during wiring. The carrier has two staggered levels for WMB markers that perfectly align with the terminal block decks. With a terminal block width of just 5 mm, an effective width of just 1.67 mm for terminal blocks of same or different potentials can be realized for conductors ranging 0.08 mm² ... 2.5 mm² (28 ... 14 AWG).

Quadruple-Deck Rail-Mount Terminal Block for Electric Motor Wiring 4 mm²; 281 Series

Technical Data

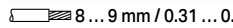
0.08 ... 4 mm ²	28 ... 12 AWG
400 V / 6 kV / 3 Ⓢ	600 V, 20 A, $\overline{V_{UL}}$
I_N 20 A (2.5 mm ²)	300 V, 25 A Ⓢ
I_N 25 A (4 mm ²)	
Terminal block width: 6 mm / 0.236 inch	
 8 ... 9 mm / 0.31 ... 0.35 inch	

Technical Data

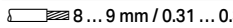
0.08 ... 4 mm ²	28 ... 12 AWG
400 V / 6 kV / 3 Ⓢ	600 V, 20 A, $\overline{V_{UL}}$
I_N 20 A (2.5 mm ²)	300 V, 25 A Ⓢ
I_N 25 A (4 mm ²)	
Terminal block width: 6 mm / 0.236 inch	
 8 ... 9 mm / 0.31 ... 0.35 inch	

Technical Data

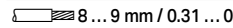
0.08 ... 4 mm ²	28 ... 12 AWG
400 V / 6 kV / 3 Ⓢ	600 V, 20 A, $\overline{V_{UL}}$
I_N 20 A (2.5 mm ²)	300 V, 25 A Ⓢ
I_N 25 A (4 mm ²)	
Terminal block width: 6 mm / 0.236 inch	
 8 ... 9 mm / 0.31 ... 0.35 inch	

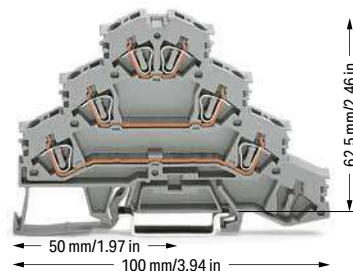
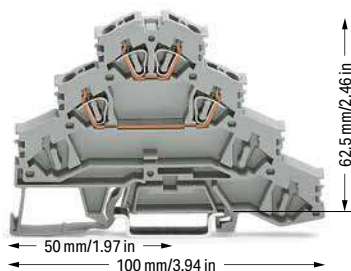
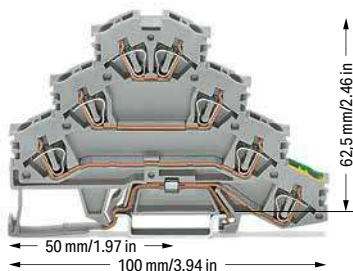

Quadruple-deck rail-mount terminal block; Rail-mount terminal block for electric motor wiring; gray

	Item No.	Pack. Unit
○ L1 - L2 - L3 - PE	281-530	50

Quadruple-deck rail-mount terminal block; Rail-mount terminal block for electric motor wiring; gray

	Item No.	Pack. Unit
○ L1 - L2	281-531	50

Quadruple-deck rail-mount terminal block; Rail-mount terminal block for electric motor wiring; gray

	Item No.	Pack. Unit
○ L1 - L2 - L3	281-532	50

Accessories; 281 Series

Appropriate marking systems: WMB/Marking strips

End and intermediate plate; 1 mm thick

	orange	281-366	100 (25)
	gray	281-365	100 (25)

	white	281-470	200 (25)
--	-------	---------	----------

Insulation stop; 0.25 ... 0.5 mm²; 5 pcs/strip

	light gray	281-471	200 (25)
--	------------	---------	----------

Insulation stop; 0.75 ... 1.5 mm²; 5 pcs/strip

	dark gray	281-472	200 (25)
--	-----------	---------	----------

Comb-style jumper bar; insulated; $I_N = I_N$ of terminal block

	2-way	281-482	100 (25)
	3-way	281-483	100 (25)
	5-way	281-485	100 (25)
	10-way	281-490	50 (25)

Alternate comb-style jumper bar; insulated; $I_N = I_N$ of terminal block

	2-way	281-492	100 (25)
--	-------	---------	----------

Operating tool; insulated

	2-way	280-432	1
	3-way	280-433	1
	5-way	281-440	1

Test plug; with 500 mm cable; 2 mm Ø; max. 42 V

	red	210-136	50
--	-----	---------	----

Marking strip; plain; 7.5 mm wide; 50 m reel

	translucent	709-177	1
---	-------------	---------	---

WMB marking card; white; 10 strips with 10 markers/card; stretchable 5 ... 5.2 mm

	plain	793-5501	5
---	-------	----------	---

- ❶ 400 V = rated voltage
6 kV = rated impulse voltage
3 = pollution degree
(see Section 15)
- Please observe the application notes:
Insulation stop, page 425
Comb-style jumper bar, page 426
Marking, from page 684
- Approvals and corresponding ratings,
visit www.wago.com

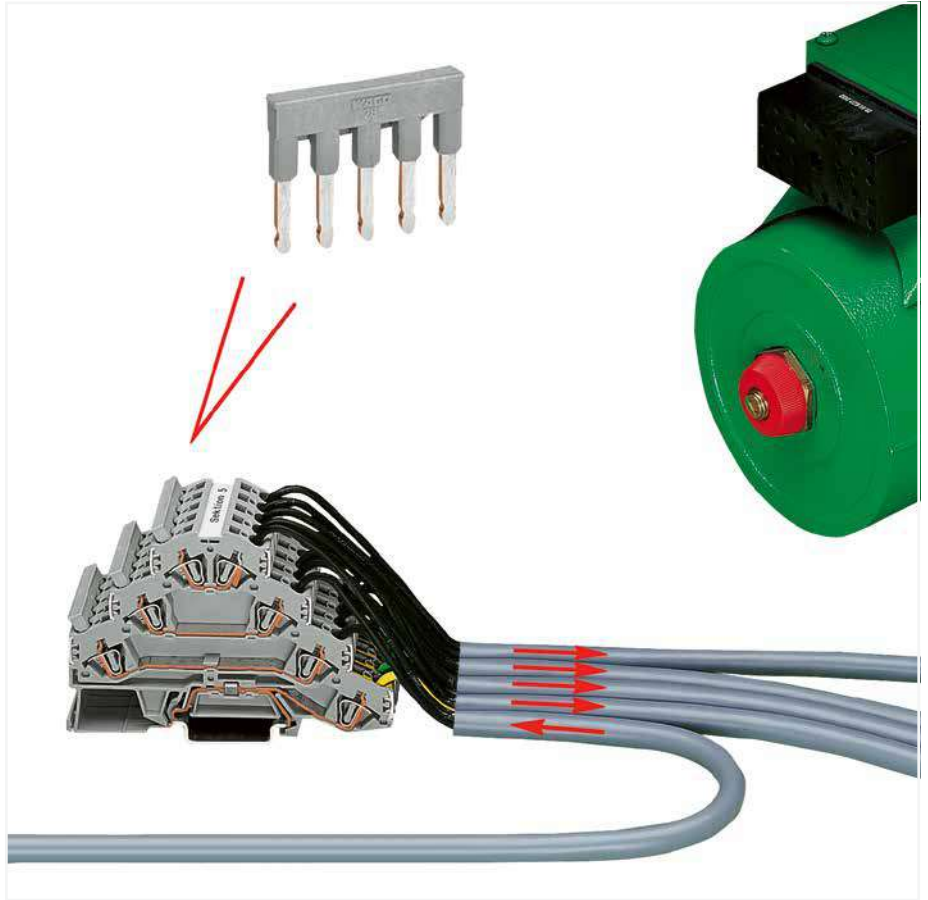

6



In addition to rail-mount terminal blocks for electric motor wiring, special versions are also available:

- Version **without** ground contact and only two potentials: These terminal blocks were custom designed to support additional functions, such as engine brakes or temperature sensors. Sharing a common profile, this terminal block version can be put next to the appropriate electric motor wiring terminal block without using intermediate plates. That makes the rail assembly easier to understand and wire. This also prevents wiring errors as no conductor entry is unused.
- Version **without** ground contact and with three potentials:

Clearly designated clamping units are the primary advantage to this terminal block design. When using devices with protective insulation, for example, there are no open ground clamping units that could create confusion.



Commoning using comb-style jumper bars. Push comb-style jumper bars down until fully inserted.



Testing with voltage tester.



Marking clamping points via WMB Multi Marking System. Marking groups via marking strips (709-177).

Rail-Mount Terminal Blocks TOPJOB® Classic

780 ... 785 Series

Description and Installation

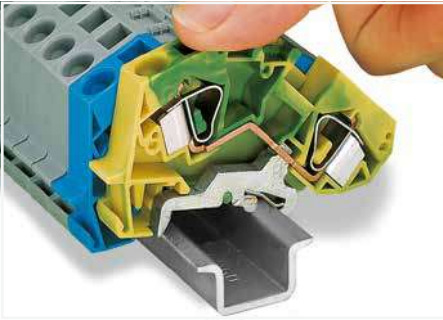

By snapping a ground conductor terminal block onto the DIN-rail, a direct electrical connection is automatically made to the rail.



Removing a terminal block from the assembly.

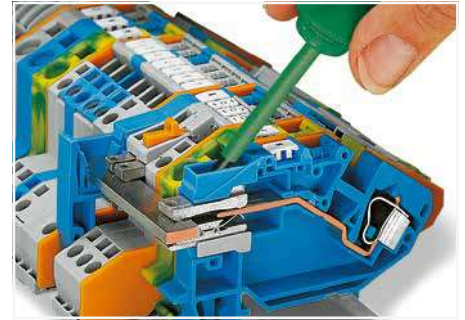

Operating an N-disconnect slide link.



Commoning ground conductor terminal blocks with through terminal blocks is possible in one direction only (via rear side of terminal block) using adjacent jumpers. Recommends using yellow-green adjacent jumpers in addition to the required marking of these blocks.



Staggered jumpers for sophisticated circuit requirements – push jumpers down until fully inserted.

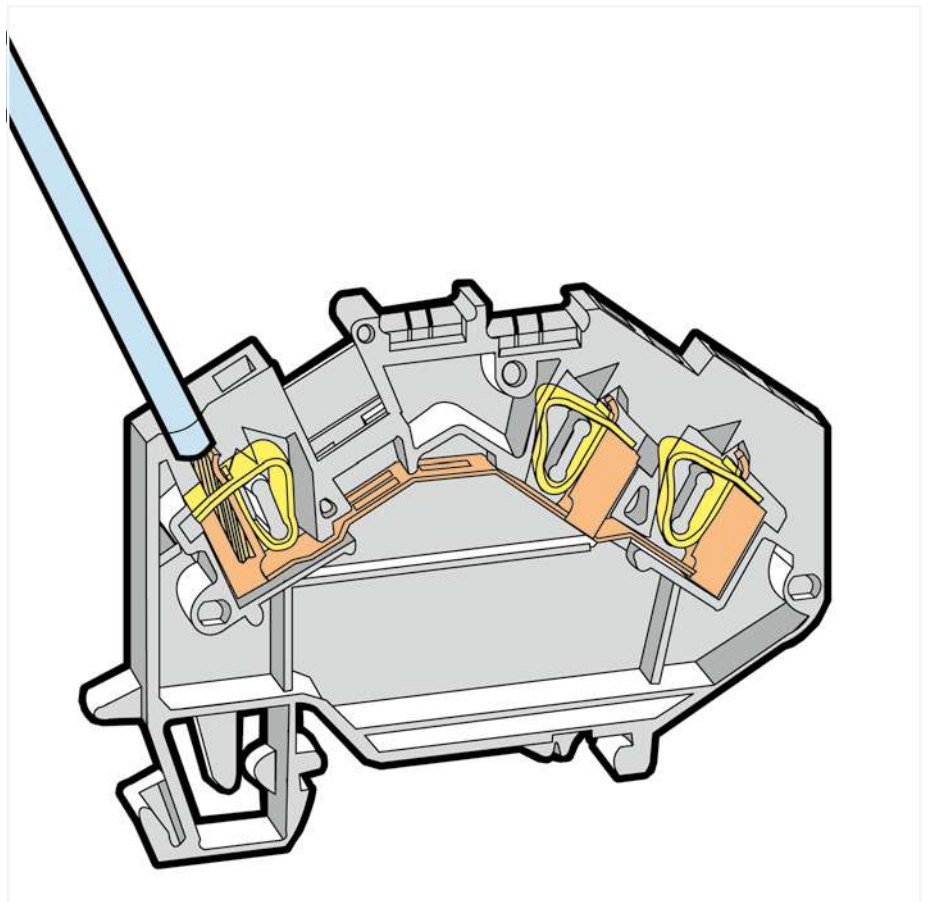

Test plug module assembly – combining test plug and spacer modules.



Insulation stop: Prevents the conductor insulation from being pushed into the clamping unit. (Available for terminal blocks up to 4 mm²/12 AWG)

CAGE CLAMP® terminates the following copper conductors:
solid "s" stranded "st"

fine-stranded "f-st", also with tinned single strands

fine-stranded, tip-bonded

fine-stranded, with ferrule (gastight crimped)

fine-stranded, with pin terminal (gastight crimped)

For aluminum conductors, see notes in Section 15. With ferruled conductors, it is necessary to use a terminal block one size larger than the conductor's nominal cross section.

Through/Ground Conductor/Shield Conductor and Ex Terminal Block TOPJOB® Classic 2.5 mm²; 780 Series

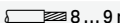
Technical Data	
0.08 ... 2.5 mm ²	28 ... 12 AWG*
1000 V / 8 kV / 3 ①	600 V, 20 A ②
I _N 24 A	600 V, 20 A ③
Terminal block width: 5 mm / 0.197 inch	
 8 ... 9 mm / 0.31 ... 0.35 inch	

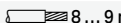
Technical Data	
0.08 ... 2.5 mm ²	28 ... 12 AWG*
1000 V / 8 kV / 3 ①	600 V, 20 A ②
I _N 24 A	600 V, 25 A ③
Terminal block width: 5 mm / 0.197 inch	
 8 ... 9 mm / 0.31 ... 0.35 inch	

*12 AWG: THHN, THWN

① 1000 V = rated voltage
8 kV = rated impulse voltage
3 = pollution degree (see Section 15)

② Terminal blocks with a blue insulated housing are suitable for Ex i applications.

③ Terminal blocks with an Ex mark are suitable for Ex e II applications.
0.2 ... 2.5 mm² / 24 ... 12 AWG*
690 V; 23 A (see Section 15)
Using staggered jumpers reduces the maximum rated voltage to 275 V.

Please observe the application notes:
Insulation stop, page 425
Jumpers, from page 426
Comb-style jumper bar, page 426
Testing accessories, from page 420
Marking, from page 684

Approvals and corresponding ratings, visit www.wago.com

Accessories; 780 Series
Appropriate marking systems:
WMB/WMB Inline/WFB

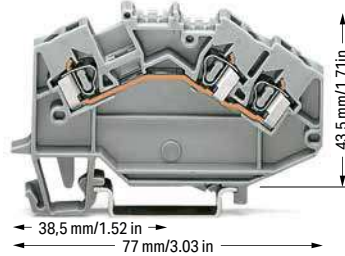
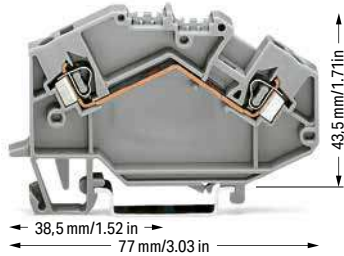

2-conductor through terminal block		
Color	Item No.	Pack. Unit
gray	780-601	50
blue	780-604 ②	50
orange	780-602	50
light gray ③	780-992 ③	50

3-conductor through terminal block		
Color	Item No.	Pack. Unit
gray	780-631	50
blue	780-651 ②	50
orange	780-654	50
light gray ③	780-993 ③	50

2-conductor ground terminal block		
Color	Item No.	Pack. Unit
green-yellow	780-607	50
green-yellow ③	780-607/999-950 ③	50

3-conductor ground terminal block		
Color	Item No.	Pack. Unit
green-yellow	780-637	50
green-yellow ③	780-637/999-950 ③	50

3-conductor shield terminal block		
Color	Item No.	Pack. Unit
white	780-640	50

Other terminal blocks with the same profile:		
N-disconnect	780-613	Page 347

Accessories; 780 Series
Appropriate marking systems: WMB/WMB Inline/WFB

End and intermediate plate; 1.5 mm thick			
Color	Item No.	Pack. Unit	Quantity
orange	780-317	100 (25)	

Alternate jumper; insulated; I _N = I _N terminal block			
Color	Item No.	Pack. Unit	Quantity
gray	280-409	100 (25)	

Ex e/Ex i separator; orange; 3 mm thick			
Length	Item No.	Pack. Unit	Quantity
125.5 mm	209-192	50 (25)	

Staggered jumper; insulated; 5 mm wide; I _N 24 A			
Configuration	Item No.	Pack. Unit	Quantity
1 to 2	780-452	100 (25)	
1 to 3	780-453	100 (25)	
1 to 4	780-454	100 (25)	
1 to 5	780-455	50 (25)	
1 to 6	780-456	50 (25)	
1 to 7	780-457	50 (25)	
1 to 8	780-458	50 (25)	

Insulation stop; 0.08 ... 0.2 mm ² "s" (0.14 mm ² "f-st"); 5 pcs/strip			
Color	Item No.	Pack. Unit	Quantity
white	280-470	200 (25)	

Push-in type wire jumper; insulated; 0.75 mm ² conductor cross section; I _N 9 A			
Length	Item No.	Pack. Unit	Quantity
L = 60 mm	249-125	100 (10)	
L = 110 mm	249-126	100 (10)	
L = 250 mm	249-127	100 (10)	

Insulation stop; 0.25 ... 0.5 mm ² ; 5 pcs/strip			
Color	Item No.	Pack. Unit	Quantity
light gray	280-471	200 (25)	

Comb-style jumper bar; insulated; I _N = I _N of terminal block			
Configuration	Item No.	Pack. Unit	Quantity
2-way	280-482	200 (25)	
3-way	280-483	200 (25)	
10-way	280-490	50 (25)	

Insulation stop; 0.75 ... 1 mm ² ; 5 pcs/strip			
Color	Item No.	Pack. Unit	Quantity
dark gray	280-472	200 (25)	

Alternate comb-style jumper bar; insulated; I _N = I _N of terminal block			
Configuration	Item No.	Pack. Unit	Quantity
2-way	280-492	200 (25)	

Protective warning marker; with black high-voltage symbol; for 5 terminal blocks			
Color	Item No.	Pack. Unit	Quantity
yellow	280-415	100 (25)	

Adjacent jumper; insulated; I _N = I _N terminal block			
Color	Item No.	Pack. Unit	Quantity
gray	280-402	200 (25)	
yellow-green	280-422	200 (25)	

Operating tool; insulated			
Configuration	Item No.	Pack. Unit	Quantity
2-way	280-432	1	
3-way	280-433	1	
10-way	280-440	1	

Test plug module; snaps together; 5 mm wide

Color	Item No.	Pack. Unit	Quantity
gray	280-418	100 (25)	

Spacer module; snaps together; 5 mm wide

Color	Item No.	Pack. Unit	Quantity
gray	280-419	100 (25)	

Test plug adapter; 8.3 mm wide; for 4 mm Ø test plug; for 1.5 ... 10 mm² terminal blocks

Color	Item No.	Pack. Unit	Quantity
gray	209-170	50 (25)	

Test plug adapter; 5 mm wide; for 4 mm Ø test plug; for 1.5 ... 4 mm² terminal blocks

Color	Item No.	Pack. Unit	Quantity
gray	280-404	100 (25)	

Test plug adapter; 6 mm wide; with CAGE CLAMP®; for 0.08 ... 2.5 mm²

Color	Item No.	Pack. Unit	Quantity
I _N 24 A	281-407	100 (25)	

Operating tool; specialty blade; for all TOPJOB® terminal blocks

Item No.	Pack. Unit	Quantity
777-310	1	

Through/Ground Conductor and Ex Terminal Block TOPJOB® Classic 4 mm²; 781 Series

Technical Data

0.08 ... 4 mm ²	28 ... 12 AWG
1000 V / 8 kV / 3 ①	600 V, 20 A ②
I _N 32 A	600 V, 20 A ③
Terminal block width: 6 mm / 0.236 inch	
9 ... 10 mm / 0.35 ... 0.39 inch	

Technical Data

0.08 ... 4 mm ²	28 ... 12 AWG
1000 V / 8 kV / 3 ①	600 V, 20 A ②
I _N 32 A	600 V, 20 A ③
Terminal block width: 6 mm / 0.236 inch	
9 ... 10 mm / 0.35 ... 0.39 inch	

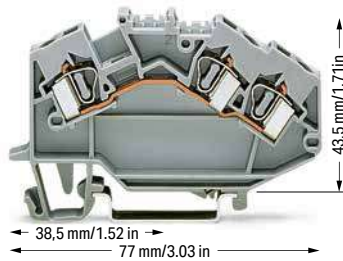
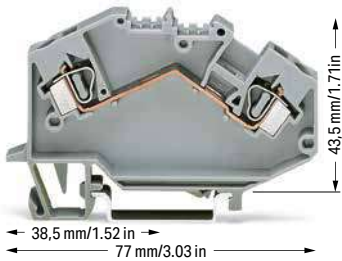

2-conductor through terminal block

Color	Item No.	Pack. Unit
gray	781-601	50
blue	781-604 ②	50
light gray ③	781-992 ③	50

3-conductor through terminal block

Color	Item No.	Pack. Unit
gray	781-631	50
blue	781-651 ②	50
light gray ③	781-993 ③	50

2-conductor ground terminal block

green-yellow	781-607	50
green-yellow ③	781-607/999-950 ③	50

3-conductor ground terminal block

green-yellow	781-637	50
green-yellow ③	781-637/999-950 ③	50

Other terminal blocks with the same profile:

N-disconnect	781-613	Page 347
Potential	781-623	Page 347

Other terminal blocks with the same profile:

N-disconnect	781-643	Page 347
Potential	781-653	Page 347

Accessories; 781 Series

Appropriate marking systems: WMB/WMB Inline/WFB

End and intermediate plate; 1.5 mm thick

orange	780-317	100 (25)
--------	---------	----------

Ex e/Ex i separator; orange; 3 mm thick

125.5 mm	209-192	50 (25)
----------	---------	---------

Insulation stop; 0.08 ... 0.2 mm² "s" (0.14 mm² "f-st"); 5 pcs/strip

white	281-470	200 (25)
-------	---------	----------

Insulation stop; 0.25 ... 0.5 mm²; 5 pcs/strip

light gray	281-471	200 (25)
------------	---------	----------

Insulation stop; 0.75 ... 1.5 mm²; 5 pcs/strip

dark gray	281-472	200 (25)
-----------	---------	----------

Protective warning marker; with black high-voltage symbol; for 5 terminal blocks

yellow	281-415	100 (25)
--------	---------	----------

Adjacent jumper; insulated; I_N = I_N terminal block

gray	281-402	200 (25)
yellow-green	281-422	200 (25)

Alternate jumper; insulated; I_N = I_N terminal block

gray	281-409	100 (25)
------	---------	----------

Staggered jumper; insulated; 6 mm wide; I_N 32 A

1 to 2	781-452	100 (25)
1 to 3	781-453	100 (25)
1 to 4	781-454	100 (25)
1 to 5	781-455	50 (25)
1 to 6	781-456	50 (25)

Push-in type wire jumper; insulated; 0.75 mm² conductor cross section; I_N 9 A

L = 60 mm	249-125	100 (10)
L = 110 mm	249-126	100 (10)
L = 250 mm	249-127	100 (10)

Comb-style jumper bar; insulated; I_N = I_N of terminal block

2-way	281-482	100 (25)
3-way	281-483	100 (25)
5-way	281-485	100 (25)
10-way	281-490	50 (25)

Alternate comb-style jumper bar; insulated; I_N = I_N of terminal block

2-way	281-492	100 (25)
-------	---------	----------

Operating tool; insulated

2-way	280-432	1
3-way	280-433	1
5-way	281-440	1

① 1000 V = rated voltage
8 kV = rated impulse voltage
3 = pollution degree
(see Section 15)

② Terminal blocks with a blue insulated housing are suitable for Ex i applications.

③ Terminal blocks with an Ex mark are suitable for Ex e II applications.
0.2 ... 4 mm² / 24 ... 12 AWG
690 V
30 A, for 2-conductor terminal blocks
27 A, for 3-conductor terminal blocks
(see Section 15)
Using staggered jumpers reduces the maximum rated voltage to 275 V.

Please observe the application notes:
Insulation stop, page 425
Jumpers, from page 426
Comb-style jumper bar, page 426
Testing accessories, from page 420
Marking, from page 684

Approvals and corresponding ratings, visit www.wago.com

Accessories; 781 Series

Appropriate marking systems:
WMB/WMB Inline/WFB

Test plug module; snaps together; 6 mm wide

gray	280-418	100 (25)
------	---------	----------

Spacer module; snaps together; 5 mm wide

gray	280-419	100 (25)
------	---------	----------

Test plug adapter; 8.3 mm wide; for 4 mm Ø test plug; for 1.5 ... 10 mm² terminal blocks

gray	209-170	50 (25)
------	---------	---------

Test plug adapter; 5 mm wide; for 4 mm Ø test plug; for 1.5 ... 4 mm² terminal blocks

gray	280-404	100 (25)
------	---------	----------

Test plug adapter; 6 mm wide; with CAGE CLAMP®; for 0.08 ... 2.5 mm²

I _N 24 A	281-407	100 (25)
---------------------	---------	----------

Operating tool; specialty blade; for all TOPJOB® terminal blocks

	777-310	1
--	---------	---

6

Through/Ground Conductor and Ex Terminal Block TOPJOB® Classic

6 mm²; 782 Series and 10 (16) mm²; 784 Series

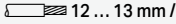
Technical Data	
0.2 ... 6 mm ²	24 ... 10 AWG
1000 V / 8 kV / 3 ②	600 V, 30 A ③
I _N 41 A	600 V, 25 A ④
Terminal block width: 8 mm / 0.315 inch	
 12 ... 13 mm / 0.47 ... 0.51 inch	

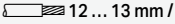
Technical Data	
0.2 ... 10 (16) mm ² ①	24 ... 6 AWG
1000 V / 8 kV / 3 ②	600 V, 50 A ③
I _N 57 A	600 V, 35 A ④
Terminal block width: 10 mm / 0.394 inch	
 12 ... 13 mm / 0.47 ... 0.51 inch	

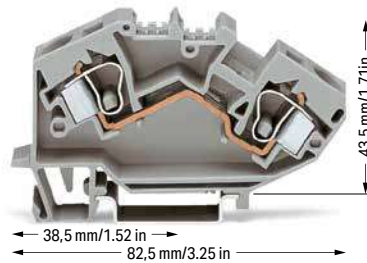
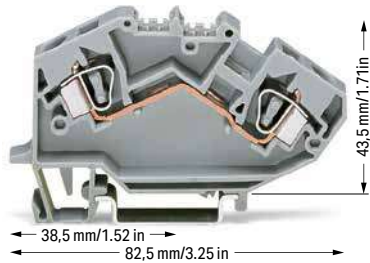

2-conductor through terminal block		
Color	Item No.	Pack. Unit
gray	782-601	25
blue	782-604 ⑤	25
light gray ⑥	782-992 ④	50



2-conductor through terminal block		
Color	Item No.	Pack. Unit
gray	784-601	25
blue	784-604 ⑤	25
light gray ⑥	784-992 ⑤	25



2-conductor ground terminal block		
Color	Item No.	Pack. Unit
green-yellow	782-607	25
green-yellow ⑥	782-607/999-950 ④	25

2-conductor ground terminal block		
Color	Item No.	Pack. Unit
green-yellow	784-607	25
green-yellow ⑥	784-607/999-950 ⑤	25

Other terminal blocks with the same profile:		
N-disconnect	782-613	Page 348
Potential	782-623	Page 348

Other terminal blocks with the same profile:		
N-disconnect	784-613	Page 348
Potential	784-623	Page 348

Accessories; item-specific			
Adjacent jumper; insulated; I _N 41 A			
	gray	282-402	100 (25)
	yellow-green	282-422	100 (25)

Accessories; item-specific			
Adjacent jumper; insulated; I _N 57 A			
	gray	284-402	100 (25)
	yellow-green	284-422	100 (25)

Alternate jumper; insulated; I _N 41 A			
	gray	282-409	100 (25)

Alternate jumper; insulated; I _N 57 A			
	gray	284-409	50 (25)

Protective warning marker; with black high-voltage symbol; for 5 terminal blocks			
	yellow	282-415	100 (25)

Protective warning marker; with black high-voltage symbol; for 5 terminal blocks			
	yellow	284-415	50 (25)

B-type test plug module; snaps together; 8 mm wide			
	gray	709-310	100 (25)

B-type test plug module; snaps together; 8 mm wide			
	gray	709-310	100 (25)

B-type spacer module; snaps together; 8 mm wide			
	gray	709-311	100 (25)

B-type spacer module; snaps together; 8 mm wide			
	gray	709-311	100 (25)

B-type spacer plate; snaps together; 2 mm wide			
	gray	709-312	100 (25)

Finger guard; touch-proof cover protects unused conductor entries			
	yellow	284-400	100 (25)

- ① Max. conductor cross section: 16 mm²
 - ② 1000 V = rated voltage
8 kV = rated impulse voltage
3 = pollution degree (see Section 15)
 - ③ Terminal blocks with a blue insulated housing are suitable for Ex i applications.
 - ④ Terminal blocks with an Ex mark are suitable for Ex e II applications.
0.2 ... 6 mm² / 24 ... 10 AWG
690 V; 39 A (see Section 15)
 - ⑤ Terminal blocks with an Ex mark are suitable for Ex e II applications.
0.2 ... 10 mm²/24 ... 8 AWG
690 V; 53 A (see Section 15)
- Please observe the application notes:
Test plug module, page 423
Marking, from page 684

Approvals and corresponding ratings, visit www.wago.com

Accessories
Appropriate marking systems:
WMB/WMB InLine/WFB

End and intermediate plate; 1.5 mm thick			
	orange	782-317	100 (25)

Ex e/Ex i separator; orange; 3 mm thick			
	125.5 mm	209-192	50 (25)

Test plug adapter; 8.3 mm wide; for 4 mm Ø test plug; for 1.5 ... 10 mm ² terminal blocks			
	gray	209-170	50 (25)

Busbar carrier; with end stop function and detachable separator plate; snaps onto DIN-35 rail; 8 mm thick			
	blue	777-305	25

Operating tool; specialty blade; for all TOPJOB® terminal blocks			
		777-310	1

Through/Ground Conductor and Ex Terminal Block TOPJOB® Classic

16 mm²; 783 Series and 35 mm²; 785 Series

Technical Data

0.2 ... 16 mm ²	24 ... 6 AWG
1000 V / 8 kV / 3 ①	600 V, 65 A W
I _N 76 A	600 V, 50 A @
Terminal block width: 12 mm / 0.472 inch	
 16 ... 17 mm / 0.63 ... 0.67 inch	

Technical Data

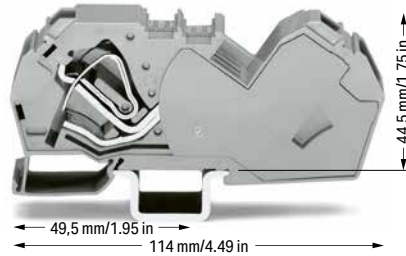
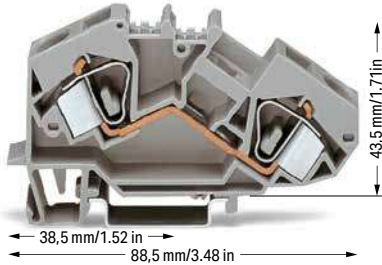

6 ... 35 mm ²	8 ... 2 AWG
1000 V / 8 kV / 3 ①	600 V, 115 A W
I _N 125 A	600 V, 125 A @
Terminal block width: 16 mm / 0.63 inch	
 23 mm / 0.91 inch	





2-conductor through terminal block

Color	Item No.	Pack. Unit
 gray	783-601	25
 blue	783-604 ②	25
 light gray ③	783-992 ③	25

2-conductor through terminal block

Color	Item No.	Pack. Unit
 gray	785-601	25
 blue	785-604	25

2-conductor ground terminal block

 green-yellow	783-607	25
 green-yellow ④	783-607/999-950 ④	25

2-conductor ground terminal block

 green-yellow	785-607	25
--	---------	----

Other terminal blocks with the same profile:

N-disconnect	783-613	Page 348
Potential	783-623	Page 348

Other terminal blocks with the same profile:

N-disconnect	785-613	Page 349
Potential	785-623	Page 349

Accessories; item-specific

End and intermediate plate; 1.5 mm thick

 orange	783-317	100 (25)
---	---------	----------

Accessories; item-specific

Adjacent jumper; insulated; I_N 85 A

 gray	285-435	50 (25)
--	---------	---------

Protective warning marker; with black high-voltage symbol; for 5 terminal blocks

 yellow	283-415	50 (25)
---	---------	---------

Protective warning marker; with black high-voltage symbol; for 5 terminal blocks

 yellow	285-416	50 (25)
--	---------	---------



Finger guard; touch-proof cover protects unused conductor entries

 yellow	283-400	100 (25)
---	---------	----------

Finger guard; touch-proof cover protects unused conductor entries

 yellow	285-401	100
--	---------	-----

Adjacent jumper; insulated; I_N 70 A

 gray	283-402	100 (25)
 yellow-green	283-422	100 (25)

Power tap; I_N 24 A; with 500 mm cable; for 16 mm² (283/783 Series) and 35 mm² (285/785 Series) rail-mount terminal blocks

 gray	283-407	25
--	---------	----

Alternate jumper; insulated; I_N 76 A

 gray	283-409	100 (25)
---	---------	----------

Test plug adapter; 11.6 mm wide; for 4 mm Ø test plug; for 1.5 ... 16 mm² terminal blocks

 gray	283-404	25
--	---------	----

Power tap; I_N 24 A; with 500 mm cable; for 16 mm² (283/783 Series) and 35 mm² (285/785 Series) rail-mount terminal blocks

 gray	283-407	25
---	---------	----

Test plug adapter; 11.6 mm wide; for 4 mm Ø test plug; for 1.5 ... 16 mm² terminal blocks

 gray	283-404	25
---	---------	----

① 1000 V = rated voltage
8 kV = rated impulse voltage
3 = pollution degree
(see Section 15)

② Terminal blocks with a blue insulated housing are suitable for Ex i applications.

④ Terminal blocks with an Ex mark are suitable for Ex e II applications.
0.2 ... 6 mm² / 24 ... 10 AWG
690 V; 39 A
(see Section 15)

⑤ Terminal blocks with an Ex mark are suitable for Ex e II applications.
0.2 ... 10 mm² / 24 ... 8 AWG
690 V; 53 A
(see Section 15)

Please observe the application notes:
Marking, from page 684

Approvals and corresponding ratings,
visit www.wago.com

Accessories

Appropriate marking systems:
WMB/WMB Inline/WFB

Test plug adapter; 8.3 mm wide; for 4 mm Ø test plug; for 1.5 ... 10 mm² terminal blocks

 gray	283-404	25
---	---------	----

Busbar carrier; with end stop function and detachable separator plate; snaps onto DIN-35 rail; 8 mm thick

 blue	777-305	25
--	---------	----

WMB marking card; white; 10 strips with 10 markers/card; for 5 ... 17.5 mm terminal block width

 plain	793-501	5
---	---------	---

WMB marking card; white; 10 strips with 10 markers/card; stretchable 5 ... 5.2 mm

 plain	793-5501	5
---	----------	---

Operating tool; specialty blade; for all TOPJOB® terminal blocks

 orange	777-310	1
--	---------	---

N-Disconnect Terminal Block and Power Distribution Disconnect Terminal Block

TOPJOB® Classic

2.5 mm²; 780 Series and 4 mm²; 781 Series

Technical Data	
0.08 ... 2.5 mm ²	28 ... 12 AWG*
400 V / 6 kV / 3 ①	600 V, 20 A ②
I _N 24 A	
Terminal block width: 5 mm / 0.197 inch	
8 ... 9 mm / 0.31 ... 0.35 inch	



1-conductor N-disconnect terminal block		
Color	Item No.	Pack. Unit
● blue	780-613 ②	50

Other terminal blocks with the same profile:		
Through	780-601	Page 303

Technical Data	
0.08 ... 4 mm ²	28 ... 12 AWG
400 V / 6 kV / 3 ①	600 V, 20 A ②
I _N 32 A	
Terminal block width: 6 mm / 0.236 inch	
9 ... 10 mm / 0.35 ... 0.39 inch	



1-conductor N-disconnect terminal block		
Color	Item No.	Pack. Unit
● blue	781-613 ②	50

1-conductor power distribution disconnect terminal block		
○ gray	781-623 ③	50

Other terminal blocks with the same profile:		
Through	781-601	Page 304

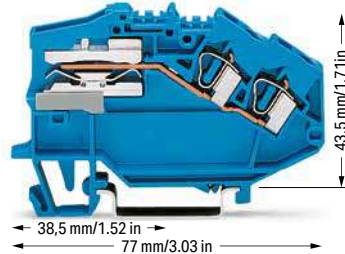

2-conductor N-disconnect terminal block		
Color	Item No.	Pack. Unit
● blue	781-643 ②	50

2-conductor power distribution disconnect terminal block		
○ gray	781-653 ③	50

Other terminal blocks with the same profile:		
Through	781-631	Page 304

- *12 AWG: THHN, THWN
- ① 400 V = rated voltage
6 kV = rated impulse voltage
3 = pollution degree
(see Section 15)
- ② See page 349
- ③ See page 349
- Approvals and corresponding ratings, visit www.wago.com

Accessories
Appropriate marking systems:
WMB/WMB Inline/WFB

End and intermediate plate; 1.5 mm thick		
	orange	780-317 100 (25)

Busbar carrier; not suitable as an end stop; snaps onto DIN-35 rail; 1.5 mm thick		
	blue	780-321 100 (25)

Busbar carrier; with end stop function and detachable separator plate; snaps onto DIN-35 rail; 8 mm thick		
	blue	777-305 25

Busbar; tin-plated; 1000 mm long; copper (10 x 3) mm		
	I _N 140 A	210-133 1

Busbar cover; 1000 mm long		
	transparent	777-303 1

Connector; for busbar; with blue cover; 2.5 ... 16 mm ²		
	blue	210-281 100 (50)

Connector; for busbar; 2.5 ... 35 mm ²		
	unplated	209-105 50

Lock-out; prevents reclosing of slide link; snap-on type		
	orange	777-300 100 (25)

Step-down test plug; from 4 mm socket to 2 mm plug; max. 42 V		
	red	210-297 100 (25)

Operating tool; specialty blade; for all TOPJOB® terminal blocks		
		777-310 1

6

N-Disconnect Terminal Block and Power Distribution Disconnect Terminal Block

TOPJOB® Classic

6 mm²; 782 Series and 10 (16) mm²; 784 Series and 16 mm²; 783 Series and 35 mm²; 785 Series

Technical Data	
0.2 ... 6 mm ²	24 ... 10 AWG
400 V / 6 kV / 3 Ⓣ	600 V, 30 A
I _N 41 A	
Terminal block width: 8 mm / 0.315 inch	
12 ... 13 mm / 0.47 ... 0.51 inch	

Technical Data	
0.2 ... 10 (16) mm ² ①	24 ... 6 AWG
400 V / 6 kV / 3 Ⓣ	
I _N 57 A	
Terminal block width: 10 mm / 0.394 inch	
12 ... 13 mm / 0.47 ... 0.51 inch	

Technical Data	
0.2 ... 16 mm ²	24 ... 6 AWG
400 V / 6 kV / 3 Ⓣ	600 V, 65 A
I _N 68 A	
Terminal block width: 12 mm / 0.472 inch	
16 ... 17 mm / 0.63 ... 0.67 inch	

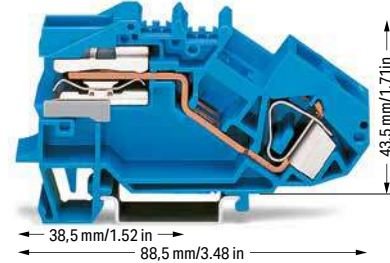
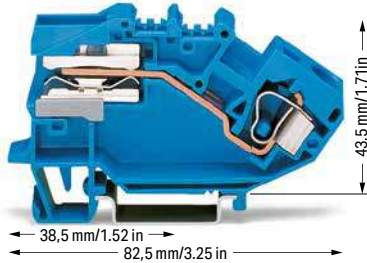
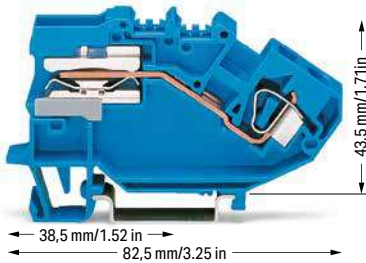

1-conductor N-disconnect terminal block		
Color	Item No.	Pack. Unit
blue	782-613	25

1-conductor N-disconnect terminal block		
Color	Item No.	Pack. Unit
blue	784-613	25

1-conductor N-disconnect terminal block		
Color	Item No.	Pack. Unit
blue	783-613	25

1-conductor power distribution disconnect terminal block		
Color	Item No.	Pack. Unit
gray	782-623	25

1-conductor power distribution disconnect terminal block		
Color	Item No.	Pack. Unit
gray	784-623	25

1-conductor power distribution disconnect terminal block		
Color	Item No.	Pack. Unit
gray	783-623	25

Other terminal blocks with the same profile:		
Through	782-601	Page 345

Other terminal blocks with the same profile:		
Through	784-601	Page 345

Other terminal blocks with the same profile:		
Through	783-601	Page 346

Accessories; item-specific			
Busbar carrier; not suitable as an end stop; snaps onto DIN-35 rail; 1.5 mm thick			
	blue	782-321	100 (25)

Accessories; item-specific			
Busbar carrier; not suitable as an end stop; snaps onto DIN-35 rail; 1.5 mm thick			
	blue	782-321	100 (25)

Accessories; item-specific			
Busbar carrier; not suitable as an end stop; snaps onto DIN-35 rail; 1.5 mm thick			
	blue	783-321	100 (25)

Accessories

Appropriate marking systems: WMB/WMB Inline/WFB

Busbar carrier; with end stop function and detachable separator plate; snaps onto DIN-35 rail; 8 mm thick			
	blue	777-305	25

Step-down test plug; from 4 mm socket to 2 mm plug; max. 42 V			
	red	210-297	100 (25)

Busbar; tin-plated; 1000 mm long; copper (10 x 3) mm			
	I _N 140 A	210-133	1

WMB marking card; white; 10 strips with 10 markers/card; for 5 ... 17.5 mm terminal block width			
	plain	793-501	5

Busbar cover; 1000 mm long			
	transparent	777-303	1

WMB marking card; white; 10 strips with 10 markers/card; stretchable 5 ... 5.2 mm			
	plain	793-5501	5

Connector; for busbar; with blue cover; 2.5 ... 16 mm ²			
	blue	210-281	100 (50)

Operating tool; specialty blade; for all TOPJOB® terminal blocks			
		777-310	1

Connector; for busbar; 2.5 ... 35 mm ²			
	unplated	209-105	50

Lock-out; prevents reclosing of slide link; snap-on type			
	orange	782-300	100 (25)

Technical Data6 ... 35 mm² | 8 ... 2 AWG

400 V / 6 kV / 3 ②

I_N 125 A | 600 V, 125 AⓈ

Terminal block width: 16 mm / 0.63 inch

23 mm / 0.91 inch

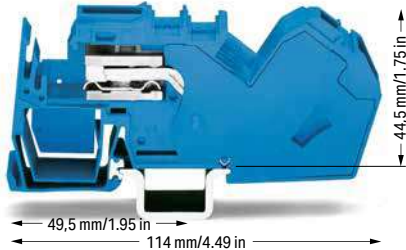
**1-conductor N-disconnect terminal block**

Color	Item No.	Pack. Unit
● blue	785-613	15

1-conductor power distribution disconnect terminal block

○ gray	785-623	15
--------	---------	----

Other terminal blocks with the same profile:

Through	783-601	Page 346
---------	---------	----------

Accessories; item-specific

Busbar carrier; not suitable as an end stop; snaps onto DIN-35 rail; 1.5 mm thick

	blue	783-321	100 (25)
---	------	---------	----------

① Max. conductor cross section: 16 mm²② 400 V = rated voltage
6 kV = rated impulse voltage
3 = pollution degree
(see Section 15)

③ See column 5 (bottom)

④ See column 6 (bottom)

Approvals and corresponding ratings,
visit www.wago.com

The 35 mm² (2 AWG) terminal blocks are the latest addition to WAGO TOPJOB®, the professional range of rail-mount terminal blocks for building installations. These terminal blocks, which include an end plate, are just 16 mm wide. Their compact design allows them to fit into standard distribution boxes. The lower conductor entry angle makes it much easier to terminate 35 mm² (2 AWG) conductors.

Furthermore, the N-busbar holder is integrated into the terminal block, eliminating separate holders.

6



Removing the separator plate from the busbar carrier or from the N-disconnect terminal block.

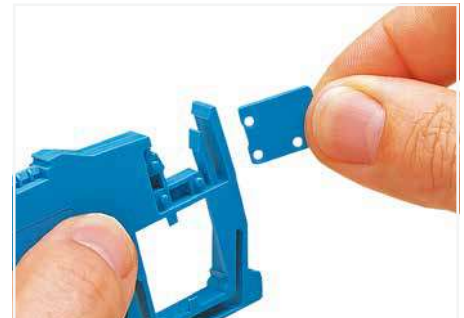

Inserting the separator plate into the busbar carrier to protect the N-busbar against accidental contact.

N-conductor disconnect terminal blocks:

For the construction and operation of power installations in fire-prone, hazardous locations or public buildings – such as conference centers, stores, hospitals, schools, theaters or hotels – the DIN VDE 0100-710 or DIN VDE 0100-718 standards shall be observed. DIN VDE 0100-482 shall also be observed for fire-prone, hazardous locations. These VDE regulations mandate that every neutral conductor must be provided with a disconnection device so, e.g., insulation testing is possible for every circuit without disconnecting the N-conductor. WAGO's N-disconnect terminal blocks meet this requirement.

Power distribution disconnect terminal blocks:

According to DIN VDE 0100-710, "Requirements for operating facilities, rooms and special installations – medical facilities," equipotential bonding conductors shall be run on a potential equalization busbar. The potential equalization busbar and the protective ground conductor busbar must be mounted in a common housing and be connected to each other using a disconnectable copper conductor of minimum 16 mm² (6 AWG). Furthermore, all equipotential bonding conductors must be connected to the potential equalization busbar and clearly arranged so they can be disconnected individually and accessed at any time. Depending on their function, they must be provided with captive marking. WAGO's power distribution disconnect terminal blocks meet these requirements.

Disconnect/Test Terminal Blocks; with a Pivoting Knife Disconnect

280 Series

Description and Installation

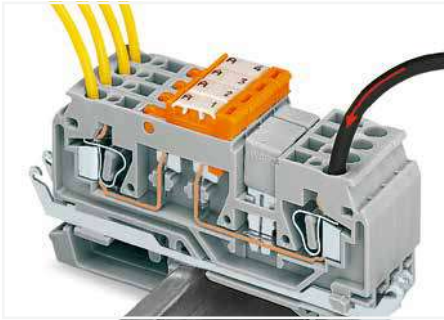

Power distribution using an adjacent jumper – knife disconnect used to disconnect individual outputs.



Pivoting a knife disconnect.

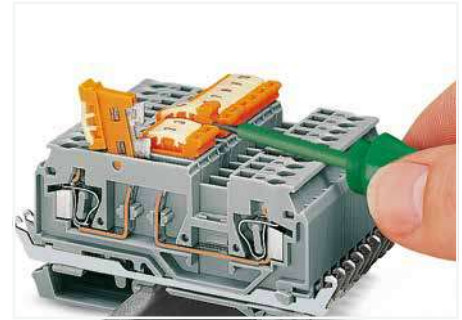

Pivoting knife disconnect clearly indicates circuit state by defined, notched positions "ON" ↔ "OFF."

6

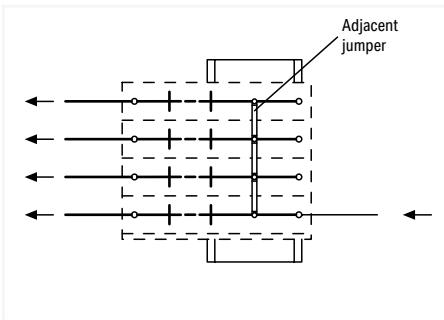
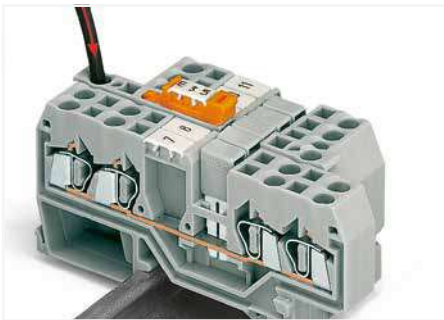

Diagram of the assembly as shown in the picture above



Power distribution using disconnect link in supply line – disconnection of all outputs.

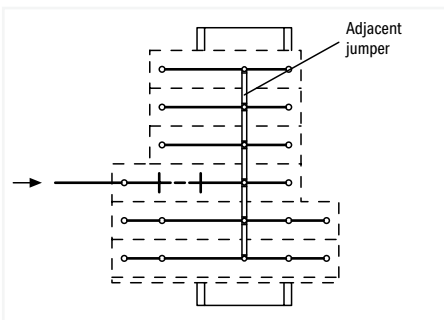
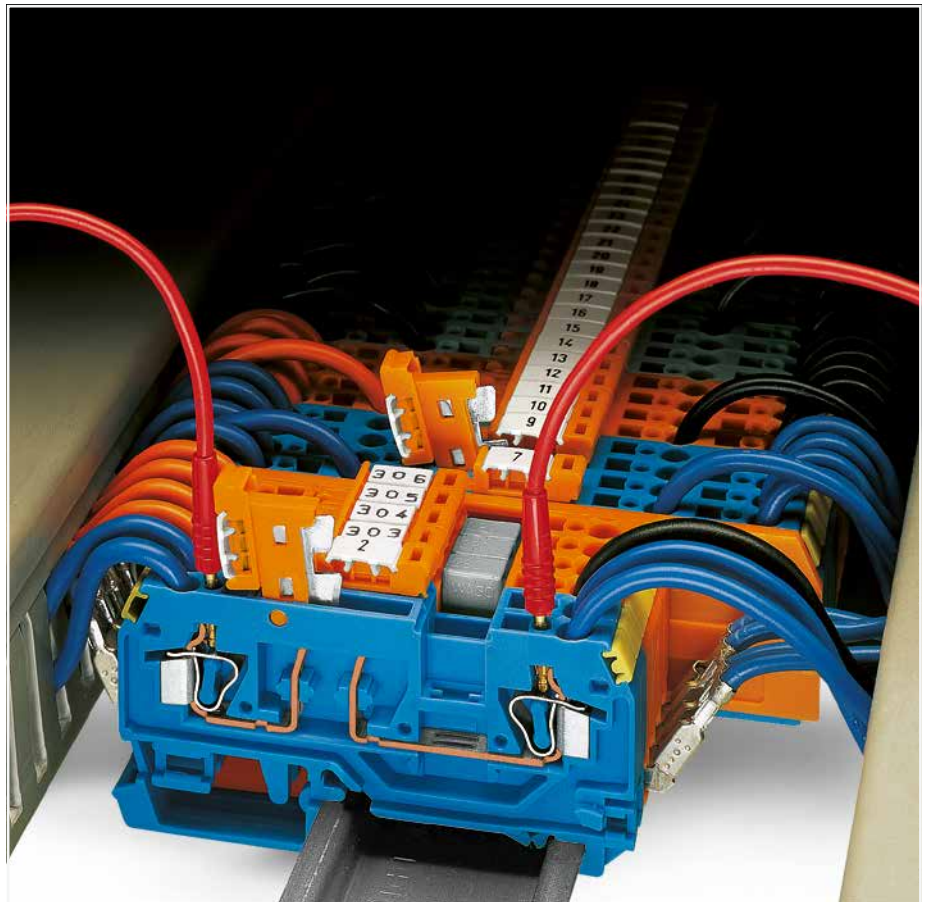

Diagram of the assembly as shown in the picture above



Staggered jumpers for sophisticated circuit requirements – push jumpers down until fully inserted.

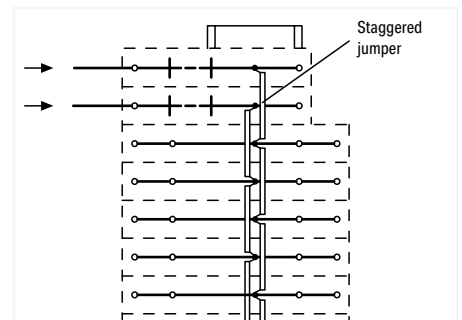

Diagram of the assembly as shown in the picture on the left



CAGE CLAMP® terminates the following copper conductors: solid "s"



stranded "st"



fine-stranded "f-st", also with tinned single strands

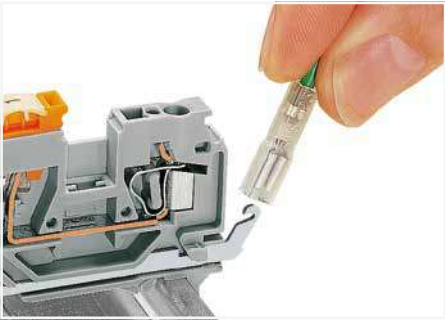

Shield contact via (2.5 x 0.8) mm solder/crimp quick disconnect terminal



Testing with voltage tester.



Terminal block marking: with WMB (center position) and Mini-WSB markers (on the sides)

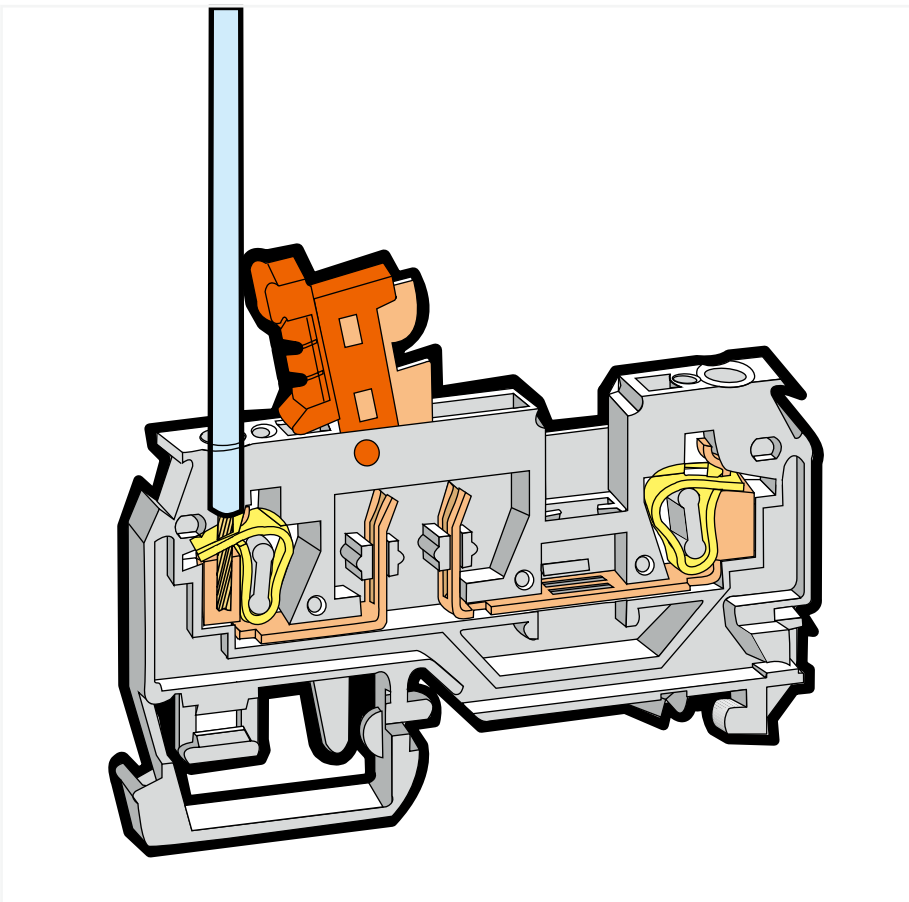

6



fine-stranded, tip-bonded



fine-stranded, with ferrule (gastight crimped)



fine-stranded, with pin terminal (gastight crimped)

2-Conductor Disconnect/Test Terminal Block without/with Shield Contact 2.5 mm²; 280 Series

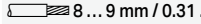
Technical Data	
0.08 ... 2.5 mm ²	28 ... 12 AWG*
400 V / 6 kV / 3 ①	600 V, 15 A VA
I _N 16 A	300 V, 15 A Ⓔ
Terminal block width: 5 mm / 0.197 inch	
 8 ... 9 mm / 0.31 ... 0.35 inch	

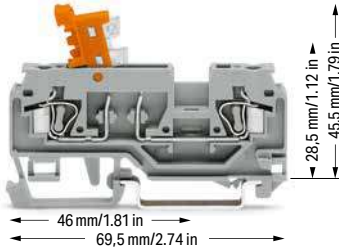

2-conductor disconnect/test terminal block; with test port; with pivoting knife disconnect
Gray terminal block housing
Orange disconnect link

Color	Item No.	Pack. Unit
○ gray	280-870	100

Gray terminal block housing
Gray disconnect link

○ gray	280-868	100
--------	---------	-----

Blue terminal block housing
Orange disconnect link

● blue	280-876 ②	100
--------	-----------	-----

Orange terminal block housing
Orange disconnect link

● orange	280-879	100
----------	---------	-----

Accessories; 280 Series

Appropriate marking systems: WMB/WMB Inline/WFB

End and intermediate plate; 2.5 mm thick

 orange	280-371	100 (25)
 gray	280-374	100 (25)

Insulation stop; 0.08 ... 0.2 mm² "s" (0.14 mm² "f-st"); 5 pcs/strip

 white	280-470	200 (25)
---	---------	----------

Insulation stop; 0.25 ... 0.5 mm²; 5 pcs/strip

 light gray	280-471	200 (25)
--	---------	----------

Insulation stop; 0.75 ... 1 mm²; 5 pcs/strip

 dark gray	280-472	200 (25)
---	---------	----------

Protective warning marker; with black high-voltage symbol; for 5 terminal blocks

 yellow	280-415	100 (25)
---	---------	----------

Adjacent jumper; insulated; I_N = I_N terminal block

 gray	280-402	200 (25)
 yellow-green	280-422	200 (25)

Alternate jumper; insulated; I_N = I_N terminal block

 gray	280-409	100 (25)
--	---------	----------

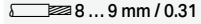
Technical Data	
0.08 ... 2.5 mm ²	28 ... 12 AWG*
250 V / 4 kV / 3 ①	600 V, 15 A VA
I _N 16 A	300 V, 15 A Ⓔ
Terminal block width: 5 mm / 0.197 inch	
 8 ... 9 mm / 0.31 ... 0.35 inch	

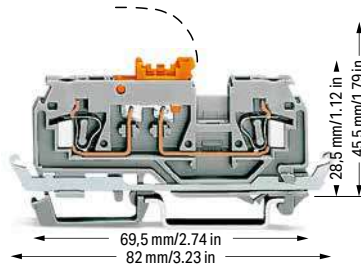

2-conductor disconnect/test terminal block; with test port; with pivoting knife disconnect
Gray terminal block housing
Orange disconnect link

Color	Item No.	Pack. Unit
○ gray	280-871	100

Gray terminal block housing
Gray disconnect link

○ gray	280-869	100
--------	---------	-----

Orange terminal block housing
Orange disconnect link

● blue	280-880	100
--------	---------	-----

Staggered jumper; insulated; 5 mm wide; I_N 24 A

 1 to 2	780-452	100 (25)
 1 to 3	780-453	100 (25)
 1 to 4	780-454	100 (25)
 1 to 5	780-455	50 (25)
 1 to 6	780-456	50 (25)
 1 to 7	780-457	50 (25)
 1 to 8	780-458	50 (25)

Push-in type wire jumper; insulated; 0.75 mm² conductor cross section; I_N 9 A

 L = 60 mm	249-125	100 (10)
 L = 110 mm	249-126	100 (10)
 L = 250 mm	249-127	100 (10)

Comb-style jumper bar; insulated; I_N = I_N of terminal block

 2-way	280-482	200 (25)
 3-way	280-483	200 (25)

Comb-style jumper bar; insulated; I_N = I_N of terminal block

 10-way	280-490	50 (25)
--	---------	---------

Alternate comb-style jumper bar; insulated; I_N = I_N of terminal block

 2-way	280-492	200 (25)
---	---------	----------

*12 AWG: THHN, THWN

① 400 V / 250 V = rated voltage
6 kV / 4 kV = rated impulse voltage
3 = pollution degree
(see Section 15)

② Terminal blocks with a blue insulated housing are suitable for Ex i applications.

Please observe the application notes:
Insulation stop, page 425
Jumpers, from page 426
Comb-style jumper bar, page 426
Testing accessories, from page 420
Marking, from page 684

Approvals and corresponding ratings, visit www.wago.com

Accessories; 280 Series

Appropriate marking systems:
WMB/WMB Inline/WFB

Operating tool; insulated

 2-way	280-432	1
 3-way	280-433	1

Operating tool; insulated

 10-way	280-440	1
--	---------	---

Test plug module; snaps together; 5 mm wide

 gray	280-418	100 (25)
--	---------	----------

Spacer module; snaps together; 5 mm wide

 gray	280-419	100 (25)
--	---------	----------

Test plug adapter; 8.3 mm wide; for 4 mm Ø test plug; for 1.5 ... 10 mm² terminal blocks

 gray	209-170	50 (25)
--	---------	---------

Test plug adapter; 5 mm wide; for 4 mm Ø test plug; for 1.5 ... 4 mm² terminal blocks

 gray	280-404	100 (25)
--	---------	----------

Test plug; with 500 mm cable; 2 mm Ø; max. 42 V

 red	210-136	50
---	---------	----

WMB marking card; white; 10 strips with 10 markers/card; stretchable 5 ... 5.2 mm

 plain	793-5501	5
---	----------	---

Mini-WSB marking card; white; 10 strips with 10 markers/card; 5 mm wide markers

 plain	248-501	5
---	---------	---

4-Conductor Disconnect/Test Terminal Block without/with Shield Contact 2.5 mm²; 280 Series

Technical Data

0.08 ... 2.5 mm ²	28 ... 12 AWG*
400 V / 6 kV / 3 ①	600 V, 15 A
I _N 16 A	300 V, 15 A

Terminal block width: 5 mm / 0.197 inch

8 ... 9 mm / 0.31 ... 0.35 inch

Technical Data

0.08 ... 2.5 mm ²	28 ... 12 AWG*
250 V / 4 kV / 3 ①	600 V, 15 A
I _N 16 A	300 V, 15 A

Terminal block width: 5 mm / 0.197 inch

8 ... 9 mm / 0.31 ... 0.35 inch

*12 AWG: THHN, THWN

- ① 400 V / 250 V = rated voltage
6 kV / 4 kV = rated impulse voltage
3 = pollution degree
(see Section 15)

- ② Terminal blocks with a blue insulated housing are suitable for Ex i applications.

Please observe the application notes:
Insulation stop, page 425
Comb-style jumper bar, page 426
Marking, from page 684

Approvals and corresponding ratings,
visit www.wago.com

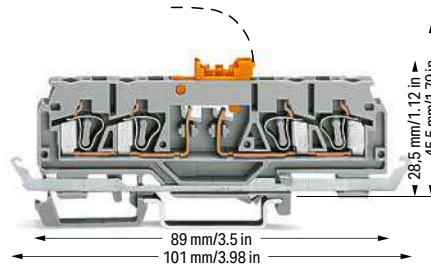
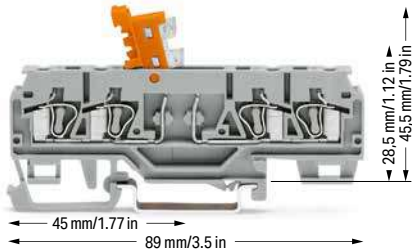

4-conductor disconnect/test terminal block; with test port; with pivoting knife disconnect
Gray terminal block housing
Orange disconnect link

Color	Item No.	Pack. Unit
gray	280-874	100

4-conductor disconnect/test terminal block; with test port; with pivoting knife disconnect
Gray terminal block housing
Orange disconnect link

Color	Item No.	Pack. Unit
gray	280-875	100

Gray terminal block housing
Gray disconnect link

gray	280-881	100
------	---------	-----

Gray terminal block housing
Gray disconnect link

gray	280-882	100
------	---------	-----

Blue terminal block housing
Orange disconnect link

blue	280-885	100
------	---------	-----

Orange terminal block housing
Orange disconnect link

blue	280-884	100
------	---------	-----

Orange terminal block housing
Orange disconnect link

orange	280-883	100
--------	---------	-----

Accessories; 280 Series

Appropriate marking systems: WMB/WMB Inline/WFB

End and intermediate plate; 2.5 mm thick

orange	280-373	100 (25)
gray	280-376	100 (25)

Alternate comb-style jumper bar; insulated; I_N = I_N of terminal block

2-way	280-492	200 (25)
-------	---------	----------

Insulation stop; 0.08 ... 0.2 mm² "s" (0.14 mm² "f-st"); 5 pcs/strip

white	280-470	200 (25)
-------	---------	----------

Operating tool; insulated

2-way	280-432	1
3-way	280-433	1

Insulation stop; 0.25 ... 0.5 mm²; 5 pcs/strip

light gray	280-471	200 (25)
------------	---------	----------

Operating tool; insulated

10-way	280-440	1
--------	---------	---

Insulation stop; 0.75 ... 1 mm²; 5 pcs/strip

dark gray	280-472	200 (25)
-----------	---------	----------

Test plug; with 500 mm cable; 2 mm Ø; max. 42 V

red	210-136	50
-----	---------	----

Protective warning marker; with black high-voltage symbol; for 5 terminal blocks

yellow	280-415	100 (25)
--------	---------	----------

Comb-style jumper bar; insulated; I_N = I_N of terminal block

2-way	280-482	200 (25)
3-way	280-483	200 (25)

Comb-style jumper bar; insulated; I_N = I_N of terminal block

10-way	280-490	50 (25)
--------	---------	---------

Disconnect/Test Terminal Block; with Disconnect Tab 2.5 mm²; 280 Series

Technical Data	
0.08 ... 2.5 mm ²	28 ... 12 AWG*
400 V / 6 kV / 3 Ⓢ	300 V, 15 A VA
I _N 10 A	300 V, 15 A Ⓢ
Terminal block width: 5 mm / 0.197 inch	
8 ... 9 mm / 0.31 ... 0.35 inch	

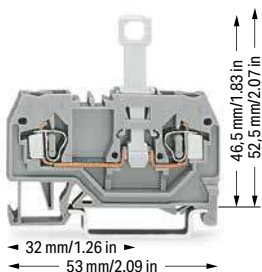

2-conductor disconnect terminal block; with disconnect tab		
Color	Item No.	Pack. Unit
gray	280-912	50
blue	280-914	50
orange	280-913	50

Other terminal blocks with the same profile:		
Through	280-901	Page 314

Accessories; item-specific			
End and intermediate plate; 2.5 mm thick			
orange	280-309	100 (25)	
gray	280-308	100 (25)	
light gray	280-356	100 (25)	
Separator; oversized; 2 mm thick			
orange	280-311	100 (25)	
gray	280-310	100 (25)	
light gray	280-357	100 (25)	

Technical Data	
0.08 ... 2.5 mm ²	28 ... 12 AWG*
400 V / 6 kV / 3 Ⓢ	300 V, 15 A VA
I _N 10 A	300 V, 15 A Ⓢ
Terminal block width: 5 mm / 0.197 inch	
8 ... 9 mm / 0.31 ... 0.35 inch	

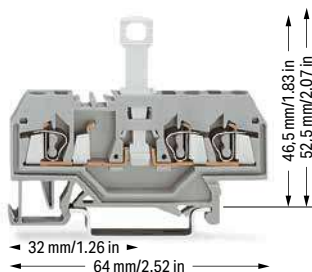

3-conductor disconnect terminal block; with disconnect tab		
Color	Item No.	Pack. Unit
gray	280-683	50

Other terminal blocks with the same profile:		
Through	280-681	Page 314

Accessories; item-specific			
End and intermediate plate; 2.5 mm thick			
orange	280-326	100 (25)	
gray	280-324	100 (25)	
light gray	280-358	100 (25)	
Separator; oversized; 2 mm thick			
orange	280-346	100 (25)	
gray	280-344	100 (25)	
light gray	280-359	100 (25)	

Technical Data	
0.08 ... 2.5 mm ²	28 ... 12 AWG*
400 V / 6 kV / 3 Ⓢ	300 V, 15 A VA
I _N 10 A	300 V, 15 A Ⓢ
Terminal block width: 5 mm / 0.197 inch	
8 ... 9 mm / 0.31 ... 0.35 inch	

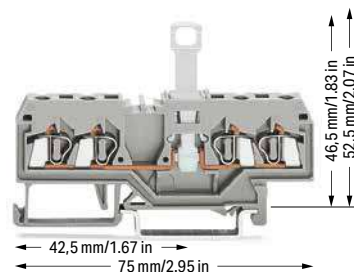

4-conductor disconnect terminal block; with disconnect tab		
Color	Item No.	Pack. Unit
gray	280-836	50
blue	280-839	50
orange	280-805	50

Other terminal blocks with the same profile:		
Through	280-833	Page 314

Accessories; item-specific			
End and intermediate plate; 2.5 mm thick			
orange	280-315	100 (25)	
gray	280-314	100 (25)	
light gray	280-352	100 (25)	
Separator; oversized; 2 mm thick			
orange	280-335	100 (25)	
gray	280-334	100 (25)	
light gray	280-353	100 (25)	

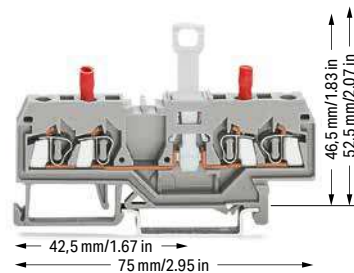

2-conductor disconnect/test terminal block; with disconnect tab; with integrated test sockets

Color	Item No.	Pack. Unit
gray	280-829	50

Accessories; item-specific			
End and intermediate plate; 2.5 mm thick			
orange	280-315	100 (25)	
gray	280-314	100 (25)	
light gray	280-352	100 (25)	
Separator; oversized; 2 mm thick			
orange	280-335	100 (25)	
gray	280-334	100 (25)	
light gray	280-353	100 (25)	

6

*12 AWG: THHN, THWN

- ① 400 V = rated voltage
- 6 kV = rated impulse voltage
- 3 = pollution degree (see Section 15)

Please observe the application notes:
 Insulation stop, page 425
 Comb-style jumper bar, page 426
 Marking, from page 684

Approvals and corresponding ratings, visit www.wago.com

Accessories; 280 Series

Appropriate marking systems:
 WMB/WMB Inline/WFB

Insulation stop; 0.08 ... 0.2 mm² "s" (0.14 mm² "f-st"); 5 pcs/strip

	white	280-470	200 (25)
---	-------	---------	----------

Insulation stop; 0.25 ... 0.5 mm²; 5 pcs/strip

	light gray	280-471	200 (25)
---	------------	---------	----------

Insulation stop; 0.75 ... 1 mm²; 5 pcs/strip

	dark gray	280-472	200 (25)
---	-----------	---------	----------

Protective warning marker; with black high-voltage symbol; for 5 terminal blocks

	yellow	280-415	100 (25)
---	--------	---------	----------

Comb-style jumper bar; insulated; I_N = I_N of terminal block

	2-way	280-482	200 (25)
	3-way	280-483	200 (25)
	10-way	280-490	50 (25)

Alternate comb-style jumper bar; insulated; I_N = I_N of terminal block

	2-way	280-492	200 (25)
---	-------	---------	----------

Operating tool; insulated

	2-way	280-432	1
	3-way	280-433	1
	10-way	280-440	1

Disconnect lock; for disconnect tab used on disconnect terminal blocks (280/281 and 769 Series)

	red	709-170	200 (25)
---	-----	---------	----------

Test socket; insulated; 2 mm Ø

	red	209-107	
---	-----	---------	--

Test socket; insulated; 2.3 mm Ø

	yellow	209-108	100 (25)
---	--------	---------	----------

Test plug; with 500 mm cable; 2 mm Ø; max. 42 V

	red	210-136	50
---	-----	---------	----

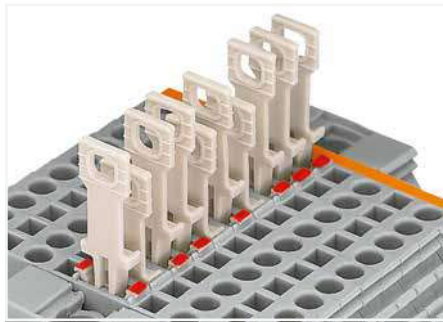

Disconnect terminal block with colored tab to indicate the switching status (red = disconnected)



Commoning front-entry disconnect terminal blocks via comb-style jumper bar using a 10-pole operating tool.

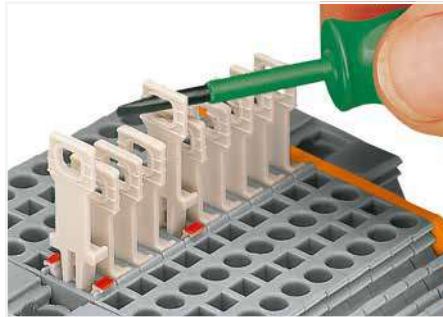

Pulling the disconnect tab via operating tool.

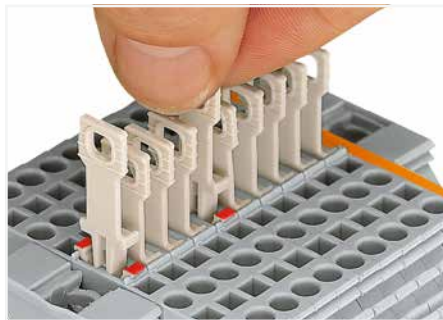

Pulling the disconnect tab by hand.

Disconnect/Test Terminal Block; with Disconnect Tab

4 mm²; 281 Series

Technical Data	
0.08 ... 4 mm ²	28 ... 12 AWG
400 V / 6 kV / 3 Ⓢ	300 V, 15 A VA
I _N 10 A	300 V, 15 A Ⓢ
Terminal block width: 6 mm / 0.236 inch	
9 ... 10 mm / 0.35 ... 0.39 inch	

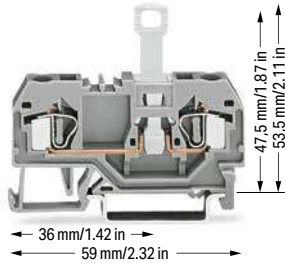

2-conductor disconnect terminal block; with disconnect tab		
Color	Item No.	Pack. Unit
○ gray	281-912	50

Technical Data	
0.08 ... 4 mm ²	28 ... 12 AWG
400 V / 6 kV / 3 Ⓢ	300 V, 15 A VA
I _N 10 A	600 V, 15 A Ⓢ
Terminal block width: 6 mm / 0.236 inch	
9 ... 10 mm / 0.35 ... 0.39 inch	

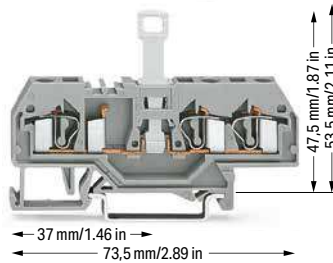

3-conductor disconnect terminal block; with disconnect tab		
Color	Item No.	Pack. Unit
○ gray	281-683	50

Technical Data	
0.08 ... 4 mm ²	28 ... 12 AWG
400 V / 6 kV / 3 Ⓢ	300 V, 15 A VA
I _N 10 A	600 V, 15 A Ⓢ
Terminal block width: 6 mm / 0.236 inch	
9 ... 10 mm / 0.35 ... 0.39 inch	

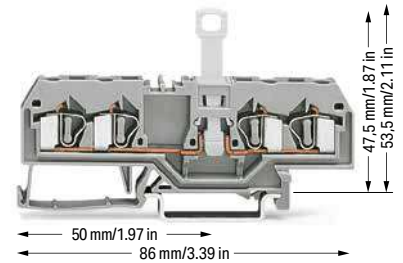

4-conductor disconnect terminal block; with disconnect tab		
Color	Item No.	Pack. Unit
○ gray	281-659	50
● blue	281-660	50

6

Other terminal blocks with the same profile:		
Through	281-901	Page 318

Other terminal blocks with the same profile:		
Through	281-681	Page 318

Other terminal blocks with the same profile:		
Through	281-652	Page 318

Accessories; item-specific			
End and intermediate plate; 2.5 mm thick			
	orange	281-329	100 (25)
	gray	281-328	100 (25)
	light gray	281-349	100 (25)

Accessories; item-specific			
End and intermediate plate; 2.5 mm thick			
	orange	281-326	100 (25)
	gray	281-324	100 (25)
	light gray	281-355	100 (25)

Accessories; item-specific			
End and intermediate plate; 2.5 mm thick			
	orange	281-335	100 (25)
	gray	281-334	100 (25)
	light gray	281-345	100 (25)

Separator; oversized; 2 mm thick			
	orange	281-331	100 (25)
	gray	281-330	100 (25)
	light gray	281-350	100 (25)

Separator; oversized; 2 mm thick			
	orange	281-346	100 (25)
	gray	281-344	100 (25)
	light gray	281-356	100 (25)

Separator; oversized; 2 mm thick			
	orange	281-339	100 (25)
	gray	281-338	100 (25)
	light gray	281-347	100 (25)

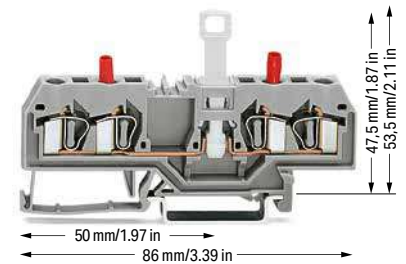

2-conductor disconnect/test terminal block; with disconnect tab; with integrated test sockets		
Color	Item No.	Pack. Unit
○ gray	281-666	50

Accessories; item-specific			
End and intermediate plate; 2.5 mm thick			
	orange	281-335	100 (25)
	gray	281-334	100 (25)
	light gray	281-345	100 (25)

Separator; oversized; 2 mm thick			
	orange	281-339	100 (25)
	gray	281-338	100 (25)
	light gray	281-347	100 (25)

- ① 400 V = rated voltage
6 kV = rated impulse voltage
3 = pollution degree
(see Section 15)

Please observe the application notes:
Insulation stop, page 425
Comb-style jumper bar, page 426
Marking, from page 684

Approvals and corresponding ratings,
visit www.wago.com

Accessories; 281 Series

Appropriate marking systems:
WMB/WMB Inline/WFB

Insulation stop; 0.08 ... 0.2 mm² "s" (0.14 mm² "f-st"); 5 pcs/strip

	white	281-470	200 (25)
---	-------	---------	----------

Insulation stop; 0.25 ... 0.5 mm²; 5 pcs/strip

	light gray	281-471	200 (25)
---	------------	---------	----------

Insulation stop; 0.75 ... 1.5 mm²; 5 pcs/strip

	dark gray	281-472	200 (25)
---	-----------	---------	----------

Protective warning marker; with black high-voltage symbol; for 5 terminal blocks

	yellow	281-415	100 (25)
---	--------	---------	----------

Comb-style jumper bar; insulated; I_N = I_N of terminal block

	2-way	281-482	100 (25)
	3-way	281-483	100 (25)
	5-way	281-485	100 (25)
	10-way	281-490	50 (25)

Alternate comb-style jumper bar; insulated; I_N = I_N of terminal block

	2-way	281-492	100 (25)
---	-------	---------	----------

Operating tool; insulated

	2-way	280-432	1
	3-way	280-433	1
	10-way	281-440	1

Disconnect lock; for disconnect tab used on disconnect terminal blocks (280/281 and 769 Series)

	red	709-170	200 (25)
---	-----	---------	----------

Test socket; insulated; 2 mm Ø

	red	209-107	
---	-----	---------	--

Test socket; insulated; 2.3 mm Ø

	yellow	209-108	100 (25)
---	--------	---------	----------

Test plug; with 500 mm cable; 2 mm Ø; max. 42 V

	red	210-136	50
---	-----	---------	----

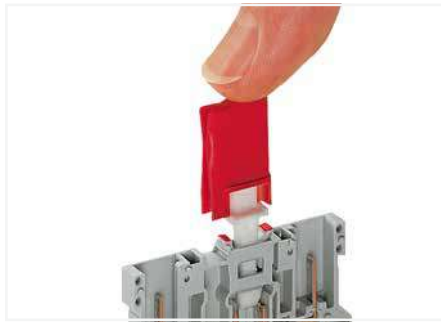

Installing a disconnect lock on the terminal block's disconnect tab (picture shows a 2-pin disconnect carrier terminal block, 769 Series).



Unlocking a disconnect lock.



Removing a disconnect lock.



Double Safety:

The disconnect tab has been designed for maximum operational safety.

As soon as the disconnect tab is in the disconnect position, it can be protected against unintentional reconnection by using the disconnect lock.

Only through intentional and focused use of a tool, can the disconnect lock be removed and the circuit reconnected.

Features/Benefits:

- Easy to use
- Install/remove disconnect lock with just one hand
- Clearly identify disconnect tab position
- Higher safety
- Intentional effort is required to reconnect the circuit

Disconnect/Test Terminal Blocks; for Current and Voltage Transformer Circuits

282 Series

Description and Installation



Inserting an insulated, touch-proof adjacent jumper into the protected shorting position.



Terminal strip permanently prepared for current transformer circuits.

6



Lock-out snaps into one of two notched positions, preventing accidental operation of the disconnect link.



Snapping a transparent locking cover onto 1-8 disconnect links:
 a) Mechanically lock several links for multi-pole switching applications
 b) Protect markers

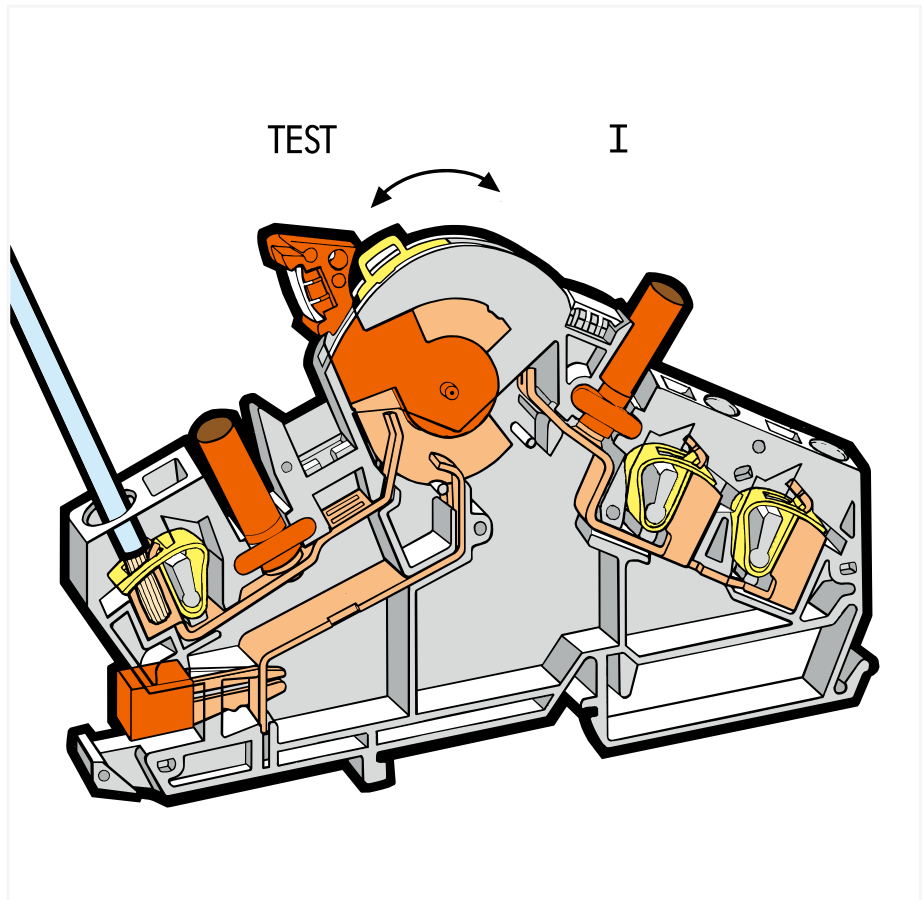

Interlocking link mechanically locks multiple links for multi-pole switching applications.



Touch-proof test sockets for touch-proof 4 mm Ø test plugs (not available from WAGO, but are offered by industry suppliers such as, Fabrikat Multi-Contact)



Labeling via WMB Multi Marking System.



CAGE CLAMP® terminates the following copper conductors:
 solid "s"



stranded "st"



fine-stranded "f-st", also with tinned single strands

With ferruled conductors, it is necessary to use a terminal block one size smaller than the conductor's nominal cross section.



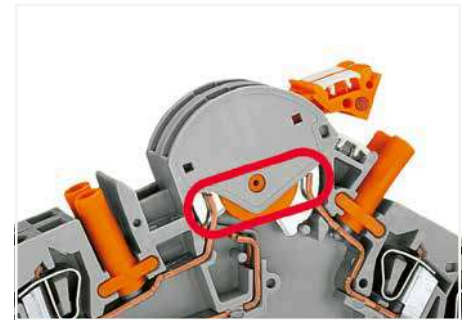
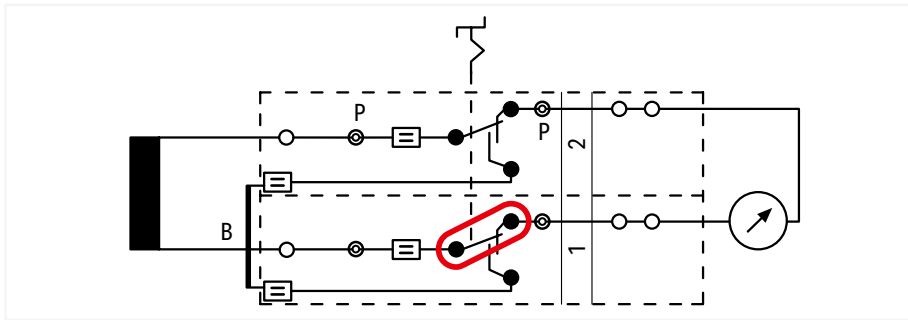

Disconnect link in notched "I" position
In "I" operating position, the measurement device is connected to the transformer.

B = shorting jumper, P = test socket

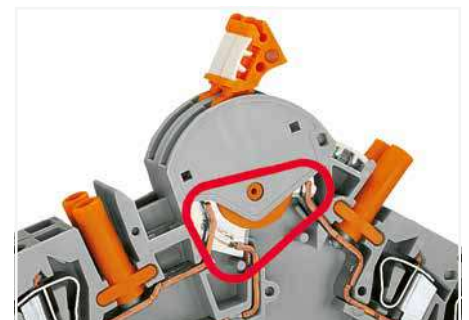
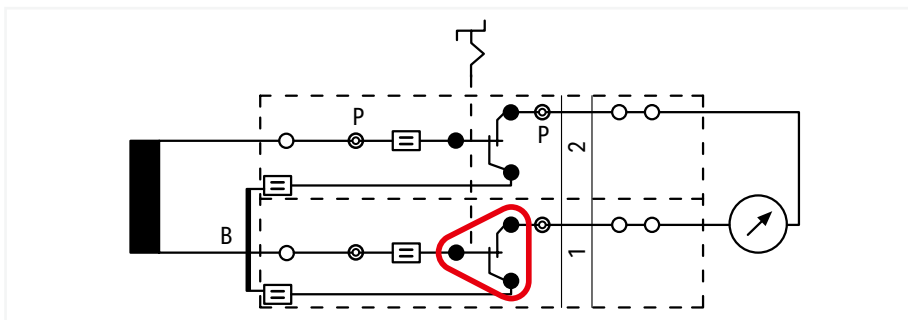

Disconnect link in transition from "I" to "TEST" (terminal blocks 1 + 2)
The transformer is not disconnected from the measurement device, yet the shorting path is activated by moving the disconnect link from "I" to "TEST."

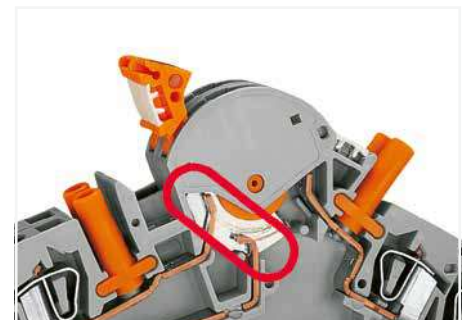
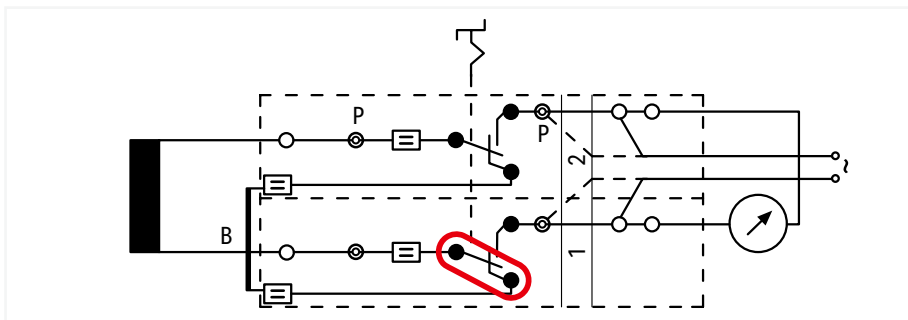

Disconnect link in notched "TEST" position (terminal blocks 1 + 2)
The measurement device/relay is electrically disconnected from the transformer. If required, external voltage can be applied to the measurement device/relay via the test socket, or the 2nd CAGE CLAMP® connection.

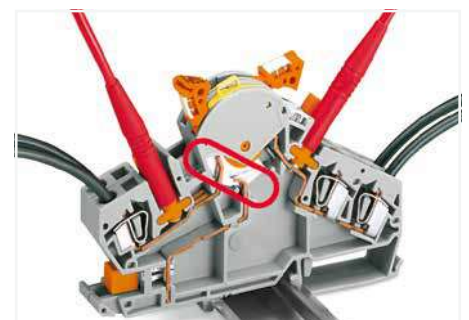
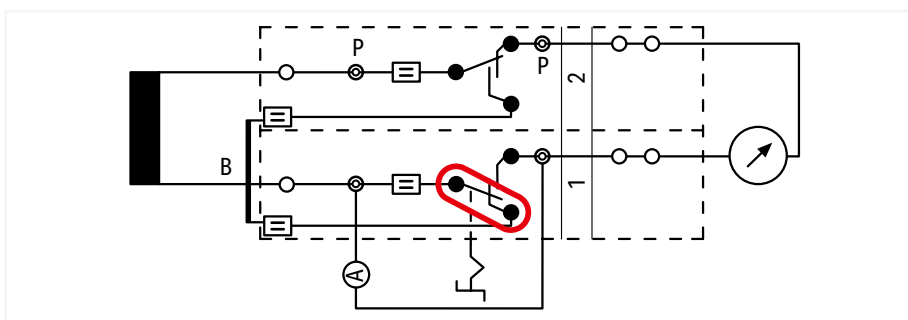

Disconnect link in notched position "I" (terminal block 2) Disconnect link in notched position "TEST" (terminal block 1) – measurement testing
Before moving the disconnect link of terminal block 1 into the notched "TEST" position, the reference current meter must be inserted into the test socket of terminal block 1.



fine-stranded,
tip-bonded



fine-stranded,
with ferrule
(gastight crimped)



fine-stranded,
with pin ferrule
(gastight crimped)

Circuit Configuration Examples

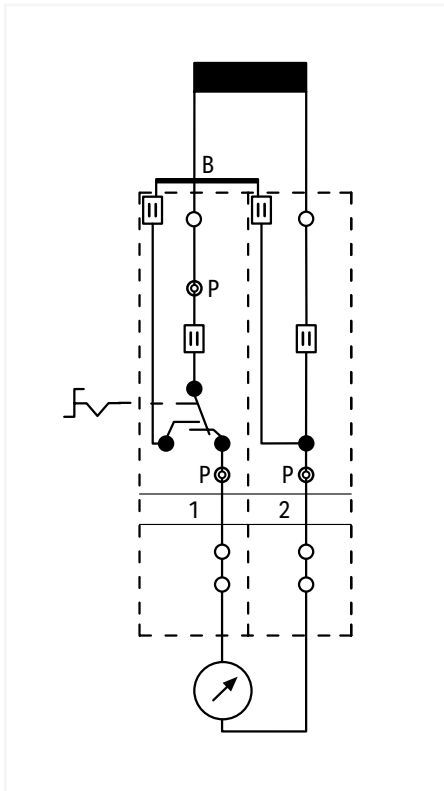

Measuring set for a single-phase current transformer
(without measurement testing)



Terminal blocks required:

- 1 x disconnect/test terminal block (282-870)
- 1 x through terminal block (282-865)
- 1 x jumper, orange (282-424)
- 1 x end plate, orange (282-386)
- In addition: locking cover, lock-out

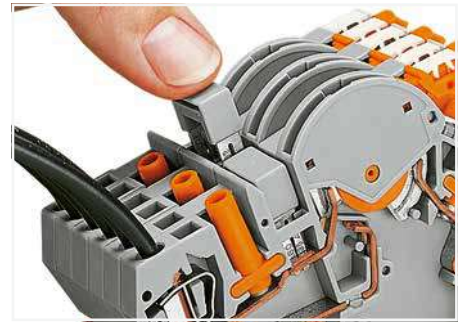

Additional commoning possible with circuit-related adjacent jumpers or testing option via test plug adapter (209-170) on transformer side.



CAGE CLAMP® connection

Inserting a conductor via operating tool (5.5 x 0.8 mm blade).

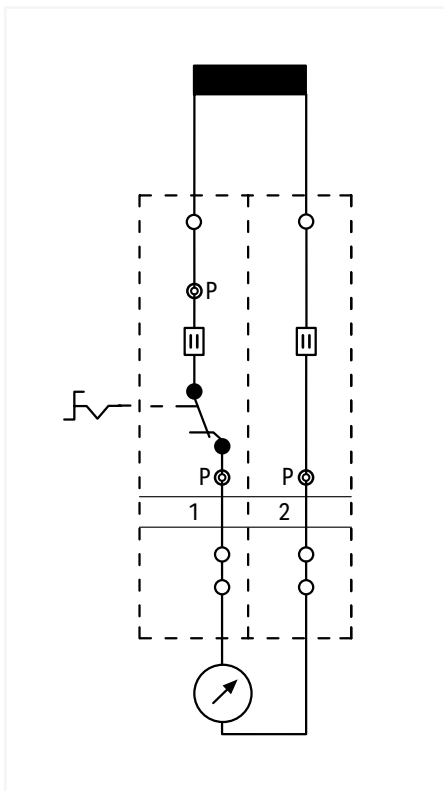

Measuring set for a single-phase voltage transformer



Terminal blocks required:

- 1 x disconnect/test terminal block (282-860)
- 1 x through terminal block (282-866)
- 1 x end plate, orange (282-386)
- In addition: locking cover, lock-out



A lock-out seal can be used on the disconnect link in notched "I" position.



Additional CAGE CLAMP® connection on the measurement device side, e.g., when connecting wire commoning chains or applying an external voltage.

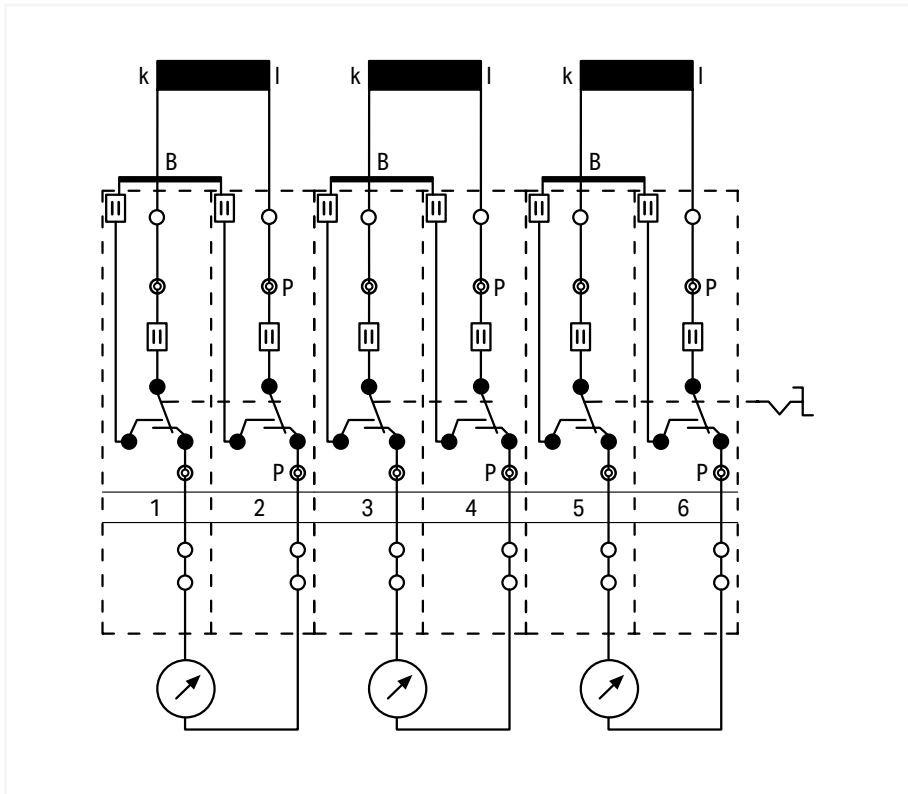

Measuring set for a three-phase current transformer
 Pairs of disconnect links are interconnected via interlocking link or locking cover.
 Measurement testing is performed after the interlocking is released.

B = shorting jumper, P = test socket

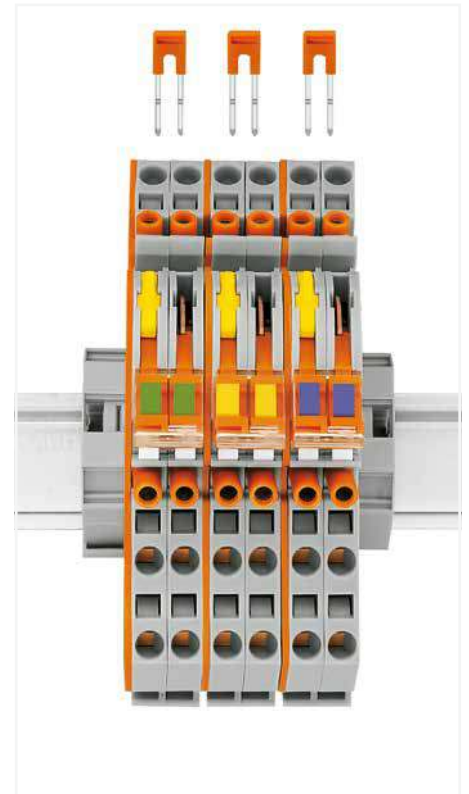

- Terminal blocks required:
- 6 x disconnect/test terminal block (282-870)
 - 3 x jumper, orange (282-424)
 - 3 x end plate, orange (282-386)
 - In addition: interlocking link, locking cover, lock-out

6

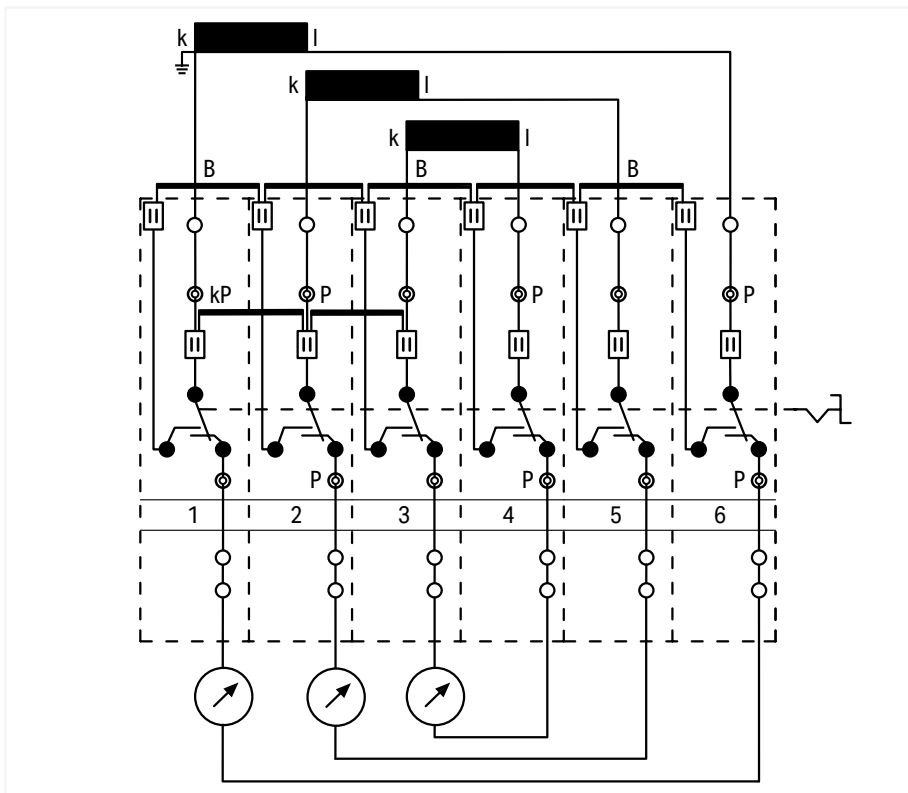

Measuring set for a three-phase current transformer with 'Y' point
 All six disconnect links are interconnected via interlocking link.

kP = 'Y' point jumper

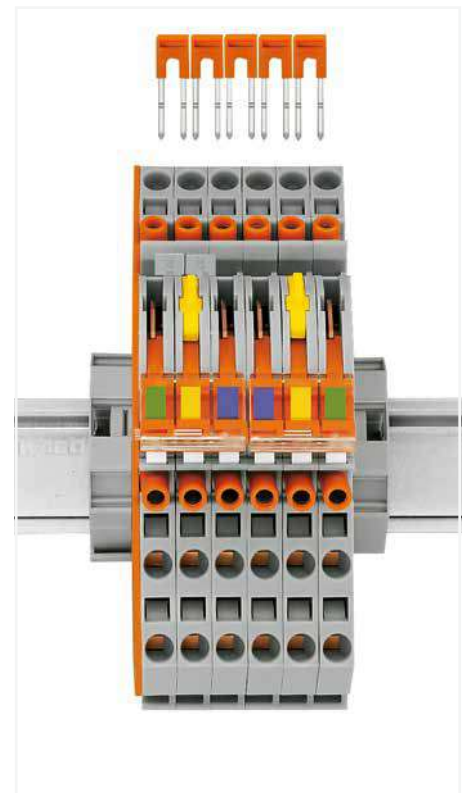

- Terminal blocks required:
- 6 x disconnect/test terminal block (282-870)
 - 5 x jumper, orange (282-424)
 - 2 x jumper, gray (282-402)
 - 1 x end plate, orange (282-386)
 - In addition: interlocking link, locking cover, lock-out

Disconnect/Test Terminal Block, Through/Ground Conductor Terminal Block; for Current and Voltage Transformer Circuits 6 mm²; 282 Series

Technical Data	
0.2 ... 6 mm ²	24 ... 10 AWG
500 V / 6 kV / 3 ⚡	600 V, 30 A ⚡
I _N 30 A	300 V, 5 A ⚡
Terminal block width: 8 mm / 0.315 inch	
12 ... 13 mm / 0.47 ... 0.51 inch	

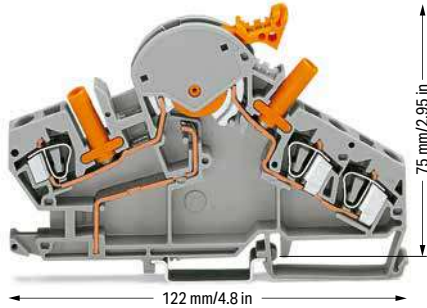

Disconnect/test terminal block; with touch-proof test sockets; for 4 mm Ø test plugs; e.g., for current transformer circuits; orange disconnect link

Color	Item No.	Pack. Unit
○ gray	282-870 ② ③	20

Accessories; item-specific
End and separator plate; 1.5 mm thick; without lock-out seal option

	orange	282-386	50 (10)
	gray	282-391	50 (10)

End and separator plate; 1.5 mm thick; with lock-out seal option

	orange	282-387	50 (10)
	gray	282-392	50 (10)

Lock-out device; for disconnect link

	yellow	282-384	100 (20)
--	--------	---------	----------

Locking cover; mechanically locks multiple links; transparent

	1-pole	282-881	50 (10)
	2-pole	282-882	50 (10)
	3-pole	282-883	50 (10)
	4-pole	282-884	50 (10)
	5-pole	282-885	50 (10)
	6-pole	282-886	50 (10)
	7-pole	282-887	50 (10)
	8-pole	282-888	50 (10)

Interlocking link; mechanically locks multiple links; 1 m long

	transparent	210-254	1
--	-------------	---------	---

Adjacent jumper; insulated; I_N 41 A

	orange	282-424	100 (25)
--	--------	---------	----------

WMB marking card; 10 strips with 10 markers/card; stretchable 5 ... 5.2 mm; yellow

	k/l (50x)	794-5553/000-002	5
--	-----------	------------------	---

Technical Data	
0.2 ... 6 mm ²	24 ... 10 AWG
500 V / 6 kV / 3 ⚡	600 V, 30 A ⚡
I _N 30 A	300 V, 5 A ⚡
Terminal block width: 8 mm / 0.315 inch	
12 ... 13 mm / 0.47 ... 0.51 inch	

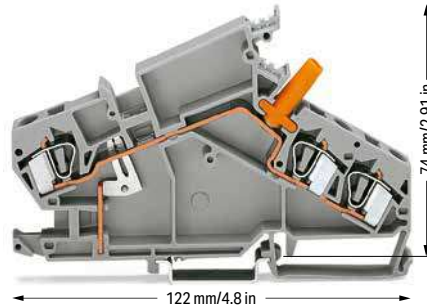

Through terminal block; with touch-proof test socket; for 4 mm Ø test plugs; e.g., for current transformer circuits

Color	Item No.	Pack. Unit
○ gray	282-865 ③	20

Accessories; item-specific
End and intermediate plate; 1.5 mm thick

	orange	282-385	50 (10)
	gray	282-390	50 (10)

WMB marking card; 10 strips with 10 markers/card; stretchable 5 ... 5.2 mm; yellow

	k/l (50x)	794-5553/000-002	5
--	-----------	------------------	---

Adjacent jumper; insulated; I_N 41 A

	orange	282-424	100 (25)
--	--------	---------	----------

Technical Data	
0.2 ... 6 mm ²	24 ... 10 AWG
500 V / 6 kV / 3 ⚡	600 V, 30 A ⚡
I _N 30 A	300 V, 5 A ⚡
Terminal block width: 8 mm / 0.315 inch	
12 ... 13 mm / 0.47 ... 0.51 inch	

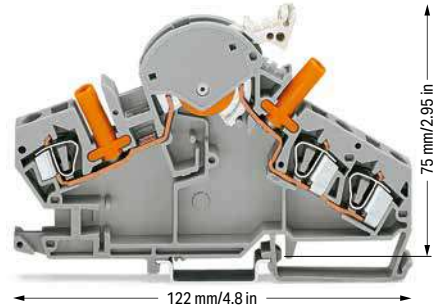

Disconnect/test terminal block; with touch-proof test sockets; for 4 mm Ø test plugs; e.g., for voltage transformer circuits; light gray disconnect link

Color	Item No.	Pack. Unit
○ gray	282-860 ② ③	20

Accessories; item-specific
End and separator plate; 1.5 mm thick; without lock-out seal option

	orange	282-386	50 (10)
	gray	282-391	50 (10)

End and separator plate; 1.5 mm thick; with lock-out seal option

	orange	282-387	50 (10)
	gray	282-392	50 (10)

Lock-out device; for disconnect link

	yellow	282-384	100 (20)
--	--------	---------	----------

Locking cover; mechanically locks multiple links; transparent

	1-pole	282-881	50 (10)
	2-pole	282-882	50 (10)
	3-pole	282-883	50 (10)
	4-pole	282-884	50 (10)
	5-pole	282-885	50 (10)
	6-pole	282-886	50 (10)
	7-pole	282-887	50 (10)
	8-pole	282-888	50 (10)

Interlocking link; mechanically locks multiple links; 1 m long

	transparent	210-254	1
--	-------------	---------	---

WMB marking card; 10 strips with 10 markers/card; stretchable 5 ... 5.2 mm; blue

	U/V (50x)	794-5554/000-006	5
--	-----------	------------------	---

6

Technical Data

0.2 ... 6 mm ²	24 ... 10 AWG
500 V / 6 kV / 3 ❶	600 V, 30 A ❷
I _N 30 A	300 V, 5 A ❸
Terminal block width: 8 mm / 0.315 inch	
12 ... 13 mm / 0.47 ... 0.51 inch	

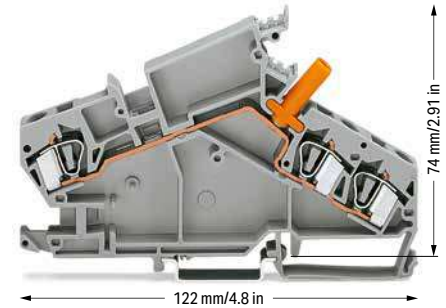

Through terminal block; with touch-proof test socket; for 4 mm Ø test plugs; e.g., for voltage transformer circuits

Color	Item No.	Pack. Unit
○ gray	282-866 ❹	20

Accessories; item-specific

End and intermediate plate; 1.5 mm thick

	orange	282-385	50 (10)
	gray	282-390	50 (10)

WMB marking card; 10 strips with 10 markers/card; stretchable 5 ... 5.2 mm; blue

	U/V (50x)	794-5554/000-006	5
--	-----------	------------------	---

Technical Data

0.2 ... 6 mm ²	24 ... 10 AWG
Terminal block width: 8 mm / 0.315 inch	
12 ... 13 mm / 0.47 ... 0.51 inch	

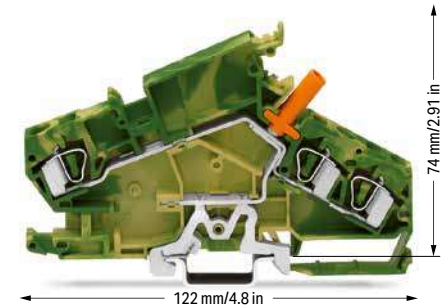

Ground conductor terminal block; with touch-proof test socket; for 4 mm Ø test plugs; e.g., for voltage transformer circuits

Color	Item No.	Pack. Unit
○ gray	282-868 ❺	20

Accessories; item-specific

End and intermediate plate; 1.5 mm thick

	orange	282-385	50 (10)
	gray	282-390	50 (10)

❶ 500 V = rated voltage
6 kV = rated impulse voltage
3 = pollution degree
(see Section 15)

❷ Max. height when rotating the disconnect link (incl. locking cover): 92 mm/3.62 inch

❸ For operating stickers, please refer to our online catalog:
• for 282-870: Item No. 210-412
• for 282-865: Item No. 210-415
• for 282-860: Item No. 210-414
• for 282-866: Item No. 210-413

Approvals and corresponding ratings, visit www.wago.com

Accessories; 282 Series

Appropriate marking systems:
WMB/WMB Inline/WFB

Protective warning marker; with black high-voltage symbol; for 5 terminal blocks

	yellow	282-415	100 (25)
--	--------	---------	----------

Adjacent jumper; insulated; I_N 41 A

	gray	282-402	100 (25)
	yellow-green	282-422	100 (25)

Alternate jumper; insulated; I_N 41 A

	gray	282-409	100 (25)
--	------	---------	----------

Wire commoning chain; insulated; 4 connections; 3 x 110 mm; I_N 24 A

	black	709-110	1
--	-------	---------	---

Wire commoning chain; insulated; 3 connections; 2 x 120 mm; I_N 24 A

	black	709-111	1
--	-------	---------	---

Wire commoning chain; insulated; 3 connections; 2 x 170 mm; I_N 24 A

	black	709-112	1
--	-------	---------	---

Group marker carrier; e.g., for 282 Series; angled

	gray	209-144	50 (25)
--	------	---------	---------

WMB marking card; white; 10 strips with 10 markers/card; for 5 ... 17.5 mm terminal block width

	plain	793-501	5
--	-------	---------	---

Transverse Switching Terminal Blocks and Longitudinal Switching Disconnect Terminal Blocks

282 Series

Description and Installation



Transverse switching terminal blocks
Left: Adjacent jumper for commoning of switching lever
Right: Commoning with orange jumper

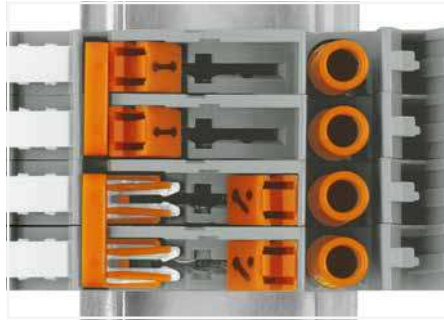

Switch positions
Left: closed
Right: open

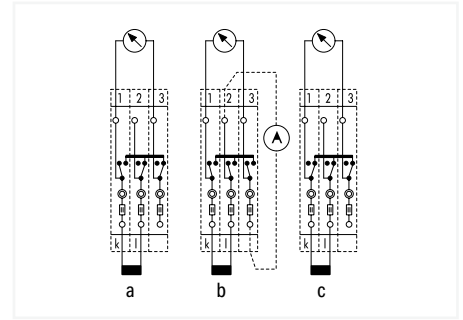

Current transformer circuit with transverse switching terminal blocks
a = Normal operation b = Transformer short circuit
c = Transformer short circuit



Testing via touch-proof 4 mm Ø test plugs (not available from WAGO, but offered by industry suppliers such as, Multi-Contact Deutschland GmbH).

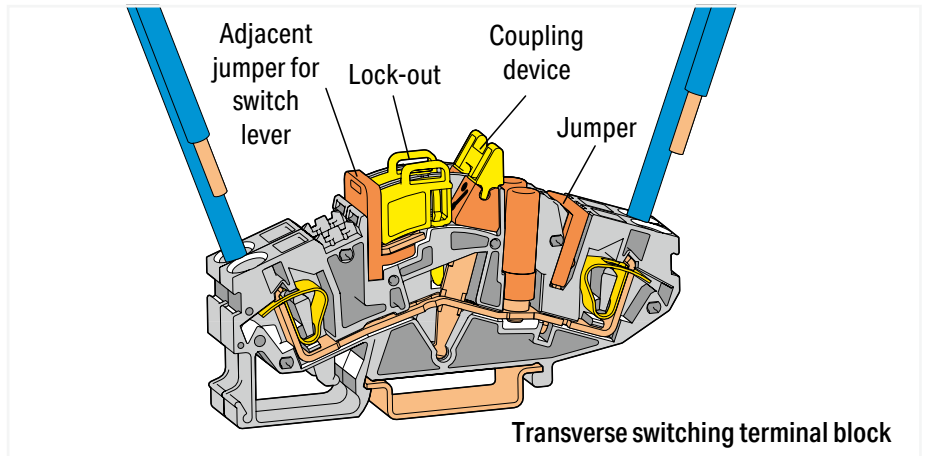

CAGE CLAMP® connection
Inserting a conductor.

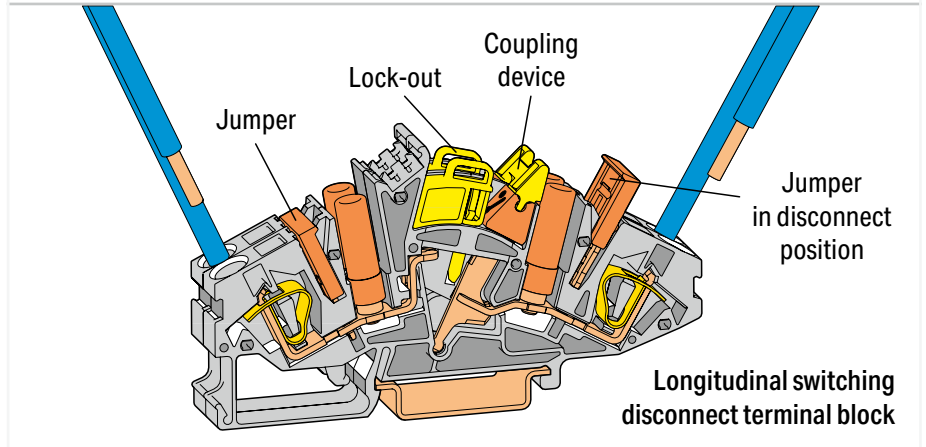

Inserting a lock-out.



Longitudinal switching disconnect terminal blocks

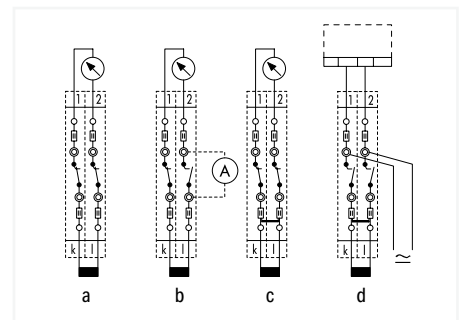

Current transformer circuit with longitudinal switching disconnect terminal blocks
a = Normal operation b = Measured value test
c = Transformer short circuit d = Relay test



CAGE CLAMP® terminates the following copper conductors:
solid "s"



stranded "st"



fine-stranded "f-st",
also with tinned
single strands

Jumpers with Safety Lid; for Longitudinal Switching Disconnect Terminal Blocks 282 Series

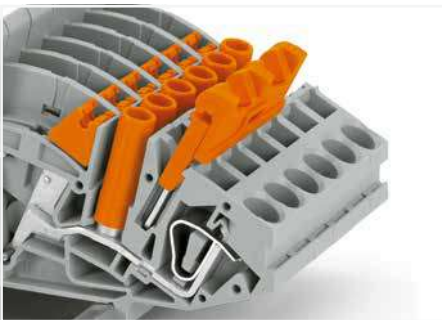

Jumper with safety lid
Jumper in pre-locked position

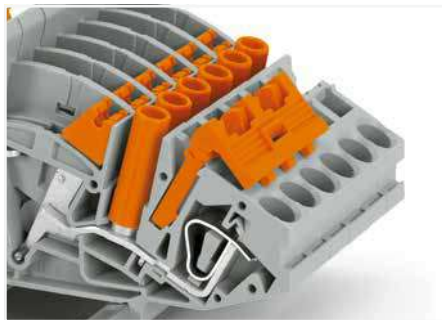

Jumper with safety lid
Longitudinal switching disconnect terminal blocks with inserted jumper, including safety lid



Jumper with safety lid
Jumper with raised safety lid



Jumper with safety lid
Removing a jumper via safety lid.



fine-stranded,
tip-bonded



fine-stranded,
with ferrule
(gastight crimped)



fine-stranded,
with pin terminal
(gastight crimped)

Transverse Switching Terminal Block, Longitudinal Switching Disconnect Terminal Block and Through Terminal Block (e.g., for Current Transformer Circuits) 6 mm²; 282 Series

Technical Data	
0.2 ... 6 mm ²	24 ... 10 AWG
500 V / 6 kV / 3 ①	600 V, 30 A VA
I _N 30 A	300 V, 36 A ⓐ
Terminal block width: 8 mm / 0.315 inch	
12 ... 13 mm / 0.47 ... 0.51 inch	

Technical Data	
0.2 ... 6 mm ²	24 ... 10 AWG
500 V / 6 kV / 3 ①	600 V, 30 A VA
I _N 30 A	300 V, 36 A ⓐ
Terminal block width: 8 mm / 0.315 inch	
12 ... 13 mm / 0.47 ... 0.51 inch	

Technical Data	
0.2 ... 6 mm ²	24 ... 10 AWG
500 V / 6 kV / 3 ①	600 V, 30 A VA
I _N 30 A	300 V, 36 A ⓐ
Terminal block width: 8 mm / 0.315 inch	
12 ... 13 mm / 0.47 ... 0.51 inch	

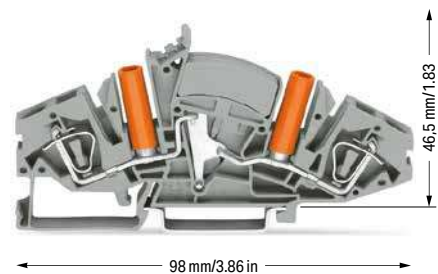
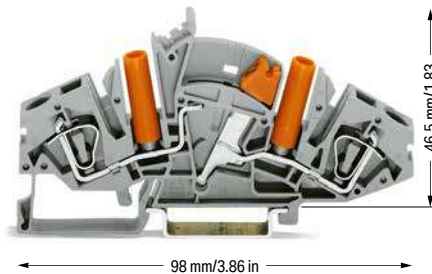

2-conductor disconnect/test terminal block; transverse switching; with touch-proof test socket; for 4 mm Ø test plug

Color	Item No.	Pack. Unit
○ gray	282-811 ②	20

2-conductor disconnect/test terminal block; longitudinal switching; with touch-proof test sockets; for 4 mm Ø test plugs

Color	Item No.	Pack. Unit
○ gray	282-821 ②	20

2-conductor through terminal block; with touch-proof test sockets; for 4 mm Ø test plugs

Color	Item No.	Pack. Unit
○ gray	282-841	20

Accessories; item-specific

End and separator plate; 1.5 mm thick

	orange	282-366	50 (10)
	gray	282-361	50 (10)

Accessories; item-specific

End and separator plate; 1.5 mm thick

	orange	282-365	50 (10)
	gray	282-360	50 (10)

Accessories; item-specific

End and separator plate; 1.5 mm thick

	orange	282-365	50 (10)
	gray	282-360	50 (10)

Lock-out device; for disconnect link

	yellow	282-370	100 (25)
--	--------	---------	----------

Lock-out device; for disconnect link

	yellow	282-370	100 (25)
--	--------	---------	----------

Coupling device; mechanically locks multiple links; yellow

	2-way	282-372	50 (10)
	3-way	282-373	50 (10)
	4-way	282-374	50 (10)

Coupling device; mechanically locks multiple links; yellow

	2-way	282-372	50 (10)
	3-way	282-373	50 (10)
	4-way	282-374	50 (10)

Adjacent jumper for switching lever; insulated; I_N 30 A; orange

	2-way	282-442	50 (10)
	3-way	282-443	50 (10)
	4-way	282-444	50 (10)
	5-way	282-445	50 (10)
	6-way	282-446	50 (10)

Accessories; 282 Series

Appropriate marking systems: WMB/WMB Inline/WFB

Protective warning marker; with black high-voltage symbol; for 5 terminal blocks

	yellow	282-415	100 (20)
--	--------	---------	----------

Jumper; insulated; I_N 30 A; orange

	1-3	282-433/011-000	50 (10)
	1-3-5	282-435/011-000	50 (10)
	1-4-5	282-435/301-000	50 (10)
	1-3-4-5	282-435/300-000	50 (10)
	1-2-4-6	282-436/301-000	50 (10)
	1-4-6	282-436/304-000	50 (10)
	1-3-5-7	282-437/011-000	50 (10)
	1-4-7	282-437/012-000	50 (10)
	1-2-5-8	282-438/300-000	50 (10)
	1-4-7-8	282-438/301-000	50 (10)
	1-3-5-7-9	282-439/011-000	50 (10)

WMB marking card; 10 strips with 10 markers/card; stretchable 5 ... 5.2 mm; yellow

	k/I (50x)	794-5553/000-002	5
--	-----------	------------------	---

Jumper; insulated; I_N 30 A; orange

	2-way	282-432	50 (10)
	3-way	282-433	50 (10)
	4-way	282-434	50 (10)
	5-way	282-435	50 (10)
	6-way	282-436	50 (10)
	7-way	282-437	50 (10)
	8-way	282-438	50 (10)
	9-way	282-439	50 (10)
	10-way	282-440	50 (10)

WMB marking card; 10 strips with 10 markers/card; stretchable 5 ... 5.2 mm; blue

	U/V (50x)	794-5554/000-006	5
--	-----------	------------------	---

Jumper with safety lid; insulated; I_N 30 A; orange

	2-way	282-432/100-000	50 (10)
	3-way	282-433/100-000	50 (10)
	4-way	282-434/100-000	50 (10)

Collective jumper carrier; for DIN-35 rail; compatible with jumpers for transverse switching terminal block (282-811) and longitudinal switching disconnect terminal block (282-821)

	gray	282-369	25
--	------	---------	----

WMB marking card; white; 10 strips with 10 markers/card; stretchable 5 ... 5.2 mm

	plain	793-5501	5
--	-------	----------	---

Technical Data0.2 ... 6 mm² | 24 ... 10 AWG

500 V / 6 kV / 3 ①

I_N 30 A

Terminal block width: 8 mm / 0.315 inch

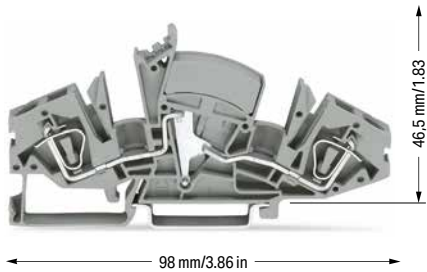
 12 ... 13 mm / 0.47 ... 0.51 inch

- ① 500 V = rated voltage
6 kV = rated impulse voltage
3 = pollution degree
(see Section 15)
- ② Max. height when rotating the disconnect link (incl. locking cover): 45 mm / 1.77 inch
For operating stickers, please refer to our online catalog:
• for 282-811: Item No. 210-424
• for 282-821: Item No. 210-423

Approvals and corresponding ratings,
visit www.wago.com

2-conductor through terminal block; without test sockets

Color	Item No.	Pack. Unit
○ gray	282-841/049-000	20

Accessories; item-specific

End and separator plate; 1.5 mm thick

	orange	282-365	50 (10)
	gray	282-360	50 (10)

Disconnect Terminal Block and Ground Conductor Disconnect Terminal Block and Through Terminal Block of Same Profile 6 mm²; 282 Series

Technical Data

0.2 ... 6 mm ²	24 ... 10 AWG
400 V / 6 kV / 3 ⚡	600 V, 30 A VA
I _N 30 A	300 V, 35 A Ⓞ
Terminal block width: 8 mm / 0.315 inch	
12 ... 13 mm / 0.47 ... 0.51 inch	

Technical Data

0.2 ... 6 mm ²	24 ... 10 AWG
800 V / 8 kV / 3 ⚡	600 V, 30 A VA
I _N 41 A	600 V, 35 A Ⓞ
Terminal block width: 8 mm / 0.315 inch	
12 ... 13 mm / 0.47 ... 0.51 inch	

Technical Data

0.2 ... 6 mm ²	24 ... 10 AWG
Terminal block width: 16 mm / 0.63 inch	
12 ... 13 mm / 0.47 ... 0.51 inch	

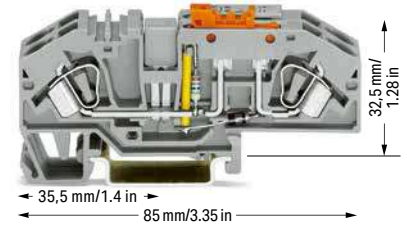
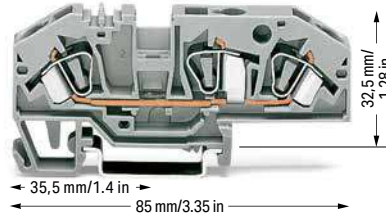
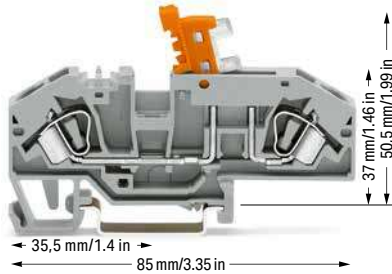

2-conductor disconnect terminal block; with test point; orange disconnect link

Color	Item No.	Pack. Unit
○ gray	282-697	25
● blue	282-695	25

3-conductor through terminal block; with test point; same profile as disconnect terminal blocks

Color	Item No.	Pack. Unit
○ gray	282-699	25
● blue	282-694	25

Ground conductor disconnect terminal block; with test point; orange disconnect link; gray

	Item No.	Pack. Unit
○ 24 V	282-640	12
○ 48 V	282-641	12
○ 120 V	282-638	12
○ 230 V	282-639	12

Other terminal blocks with the same profile:

Through	282-699	Page 368
---------	---------	----------

Other terminal blocks with the same profile:

Disconnect	282-697	Page 368
Ground cond. disc.	282-640	Page 368
Fuse	282-696	Page 330

Other terminal blocks with the same profile:

Through	282-699	Page 368
---------	---------	----------

Accessories; item-specific

Adjacent jumper; insulated; I_N 41 A

gray	282-402	100 (25)
------	---------	----------

Accessories; item-specific

Adjacent jumper; insulated; I_N 41 A

gray	282-402	100 (25)
------	---------	----------

Alternate jumper; insulated; I_N 41 A

gray	282-409	100 (25)
------	---------	----------

Alternate jumper; insulated; I_N 41 A

gray	282-409	100 (25)
------	---------	----------

Test plug adapter; 8.3 mm wide; for 4 mm Ø test plug; for 1.5 ... 10 mm² terminal blocks

gray	209-170	50 (25)
------	---------	---------

Test plug adapter; 8.3 mm wide; for 4 mm Ø test plug; for 1.5 ... 10 mm² terminal blocks

gray	209-170	50 (25)
------	---------	---------

B-type test plug module; snaps together; 8 mm wide

gray	709-310	100 (25)
------	---------	----------

B-type test plug module; snaps together; 8 mm wide

gray	709-310	100 (25)
------	---------	----------

B-type spacer module; snaps together; 5 mm wide

gray	709-311	100 (25)
------	---------	----------

B-type spacer module; snaps together; 5 mm wide

gray	709-311	100 (25)
------	---------	----------

Accessories; 282 Series

Appropriate marking systems: WMB/WMB Inline/WFB

End plate; 2 mm thick

orange	282-333	100 (25)
gray	282-334	100 (25)

Protective warning marker; with black high-voltage symbol; for 5 terminal blocks

yellow	282-415	100 (25)
--------	---------	----------

① 400 V / 800 V = rated voltage
 6 kV / 8 kV = rated impulse voltage
 3 = pollution degree
 (see Section 15)

Approvals and corresponding ratings,
 visit www.wago.com



Ground conductor disconnect terminal block – top view

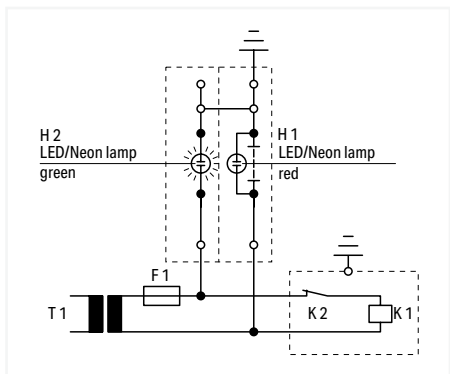

Operating condition
 Slide link closed, auxiliary circuit grounded,
 green LED/neon lamp illuminates.

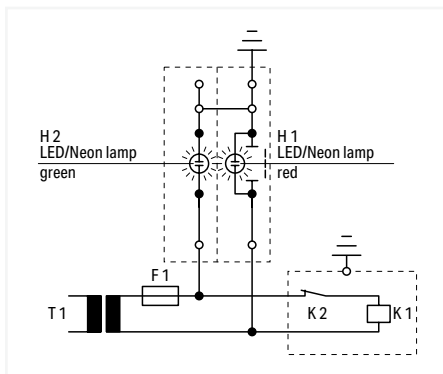

Test condition – no grounding
 Slide link open, auxiliary circuit not grounded.

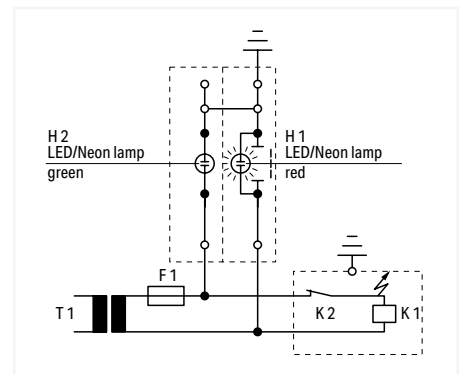

Test condition – grounding
 Slide link open, auxiliary circuit not grounded,
 red LED/neon lamp illuminates.



Testing via conductor entry.



Testing via jumper contact slot.

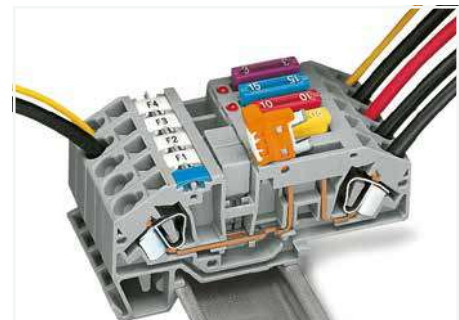

Power supply via disconnect link – disconnecting all outputs.

IEC 60204/DIN VDE 0113 "Safety of machinery – Electrical equipment of machines – Part 1: General requirements," Section 9.4.3.1:

Ground faults on control circuits must not cause unintentional starting, hazardous movements, or prevent stopping of the machine.

In order to fulfill this requirement, a connection to the protective bonding circuit must be provided in accordance with Section 8.2 and the devices must be connected as described in Section 9.1.4. Control circuits fed from a transformer and not connected to the protective bonding circuit must be provided with an insulation monitoring device (e.g., residual current device), which either indicates a ground fault or interrupts the circuit automatically after a ground fault.

In the case of electronic circuits, the connection of one side of the control circuit to the protective bonding circuit in accordance with Section 9.1.4 can prevent unintentional operation. When this does not help, or if due to other reasons that electronic circuits cannot be connected to the protective bonding circuit, other measures must be taken to achieve the same level of safety.

Multipole control switches that interrupt all live conductors must be used where the control circuit is directly connected between the phase conductors of the supply or between a phase conductor and a neutral conductor, which is either not grounded or grounded through a high impedance. This is required for starting or stopping machine functions, which can cause a hazardous situation including: damaging the machine or halting work in progress in the event of unintentional starting or failure to stop.

Fuse Terminal Block for Automotive Blade-Style Fuses

6 mm²; 282 Series

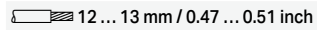
Technical Data	
0.2 ... 6 mm ²	24 ... 10 AWG
400 V / 6 kV / 3 ①	12 V, 30 A VA
I _N 25 A (30 A) ②	12 V, 30 A AE
Terminal block width: 8 mm / 0.315 inch	
 12 ... 13 mm / 0.47 ... 0.51 inch	

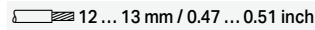
Technical Data	
0.2 ... 6 mm ²	24 ... 10 AWG
400 V / 6 kV / 3 ①	24 V, 30 A VA
I _N 25 A (30 A) ②	24 V, 30 A AE
Terminal block width: 8 mm / 0.315 inch	
 12 ... 13 mm / 0.47 ... 0.51 inch	

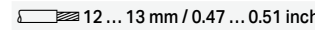
Technical Data	
0.2 ... 6 mm ²	24 ... 10 AWG
400 V / 6 kV / 3 ①	600 V, 30 A VA
I _N 25 A (30 A) ②	24 V, 30 A AE
Terminal block width: 8 mm / 0.315 inch	
 12 ... 13 mm / 0.47 ... 0.51 inch	

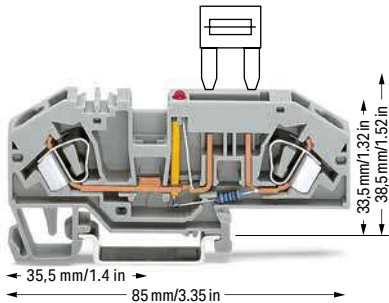

282-698/281-429

282-698/281-449

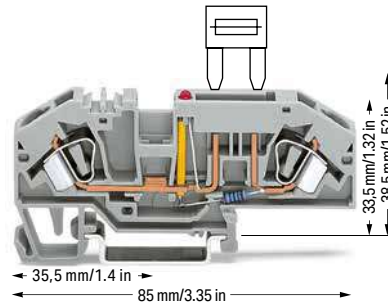

282-698/281-413

282-698/281-434

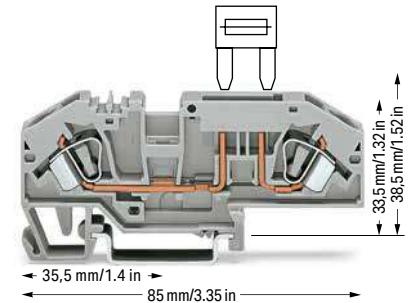

85 mm / 3.35 in

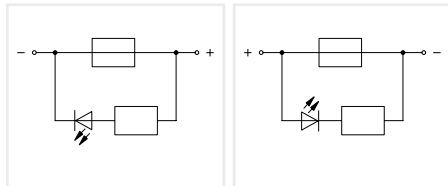

2-conductor fuse terminal block for automotive blade-style fuses; 12 V; with test point; with blown fuse indication by LED; LED power consumption: 4.8 mA
Electrical ratings are given by the fuse and blown fuse indication. Blade-style fuses: Observe touch-proof protection for 42 V and higher voltages!

Color	Item No.	Pack. Unit
○ gray	282-698/281-429	25
○ gray	282-698/281-449	25

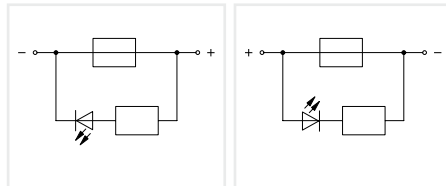

2-conductor fuse terminal block for automotive blade-style fuses; 24 V; with test point; with blown fuse indication by LED; LED power consumption: 4.8 mA
Electrical ratings are given by the fuse and blown fuse indication. Blade-style fuses: Observe touch-proof protection for 42 V and higher voltages!

Color	Item No.	Pack. Unit
○ gray	282-698/281-413	25
○ gray	282-698/281-434	25

2-conductor fuse terminal block for automotive blade-style fuses; with test point; without blown fuse indication; Electrical ratings are given by the fuse. Blade-style fuses: Observe touch-proof protection for 42 V and higher voltages!

Color	Item No.	Pack. Unit
○ gray	282-696	25

Other terminal blocks with the same profile:		
Through	282-699	Page 368

Accessories; 282 Series

Appropriate marking systems: WMB/Marking strips

End plate; 2 mm thick			
	gray	282-333	100 (25)
	orange	282-334	100 (25)

Adjacent jumper; insulated; I _N 41 A			
	gray	282-402	100 (25)
	yellow-green	282-422	100 (25)

Alternate jumper; insulated; I _N 41 A			
	gray	282-409	100 (25)

Test plug adapter; 8.3 mm wide; for 4 mm Ø test plug; for 1.5 ... 10 mm ² terminal blocks			
	gray	209-170	50 (25)

B-type test plug module; snaps together; 8 mm wide			
	gray	709-310	100 (25)

B-type spacer module; snaps together; 5 mm wide			
	gray	709-311	100 (25)

- ❶ 400 V = rated voltage
6 kV = rated impulse voltage
3 = pollution degree
 - ❷ LED power consumption: 4.8 mA
- Blade-style fuses are not offered by WAGO.
Thermal automotive circuit breakers are not offered by WAGO.
WAGO recommends automotive circuit breakers from ETA.
- Please observe the application notes:
Marking, from page 684
- Approvals and corresponding ratings,
visit www.wago.com

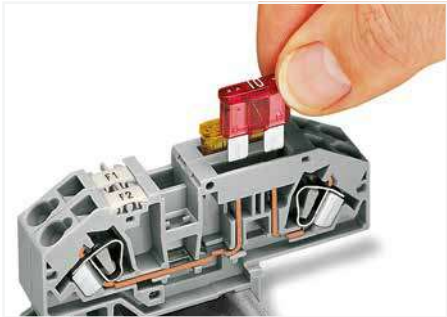

Inserting a fuse.



Blown fuse indication by LED

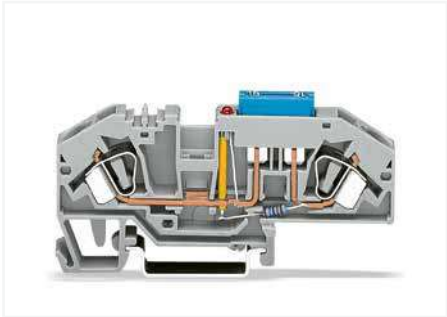

2-conductor fuse terminal block with mini-automotive blade-style fuse

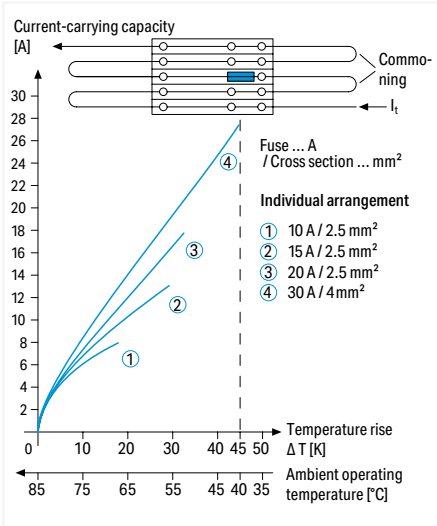

Application Notes on Fuse Terminal Blocks
Diagram: Individual arrangement

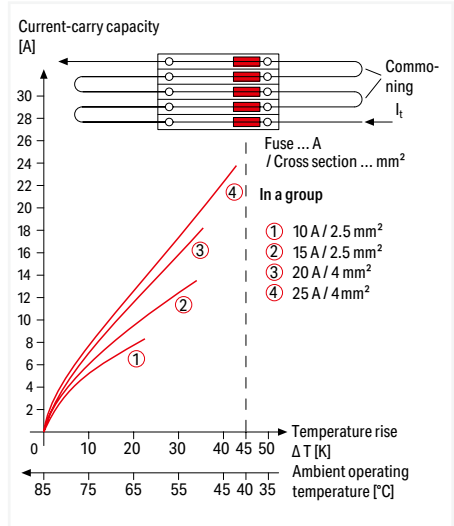

Application Notes on Fuse Terminal Blocks
Diagram: Block arrangement

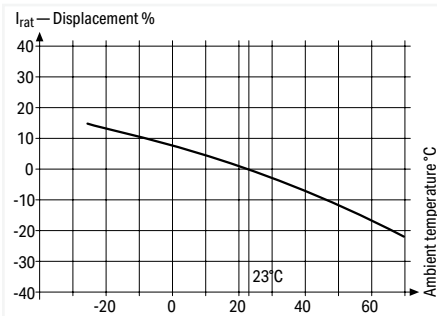

Application Notes on Fuse Terminal Blocks
Nominal current ratings for fuse cartridges are defined differently in international standards. This is why the recommended continuous current-carrying capacity of the fuses is a max. 80% of their nominal current according to DIN 72581/Part 3 (for a surrounding air temperature of 23°C).
Selecting the correct fuse cartridge is important for product safety within applications, as well as for fuse cartridge service life and reliability. Fuse cartridges will only operate perfectly as protection components (break-off point) if they are properly selected and used as intended (i.e., according to the state of the technology and valid specifications, as well as data sheet characteristics), according to basic safety requirements (i.e., persons, animals and property must be protected against hazards).

Information from the mini-automotive, blade-type fuse manufacturers

Derating T _{amb} / °C	%	F _T
-25	14	0.877
-20	13	0.885
-15	12	0.893
-10	11	0.901
- 5	10	0.909
0	9	0.917
5	8	0.926
10	6	0.943
15	4	0.962
20	2	0.980
23	0	1.000
30	- 2	1.020
35	- 4	1.042
40	- 6	1.064
45	- 8	1.087
50	-10	1.111
55	-13	1.149
60	-16	1.190
65	-19	1.235
70	-22	1.282

With regard to product safety, fuse cartridges must generally be tested both under normal and faulty operating conditions within your application.

Fused Disconnect Terminal Blocks with a Pivoting Fuse Holder; for Glass Cartridge Fuses

282 Series

Description and Installation



Blown fuse indication by LED or neon lamp



Fuse replacement:
Before replacing a fuse, pivot the fuse holder into the locked open position.



Fuse replacement:
One end of the fuse is automatically ejected from the holder when opening the cover.



CAGE CLAMP® connection
Inserting a conductor.
With ferruled conductors, it is necessary to use a terminal block one size smaller than the conductor's nominal cross section.

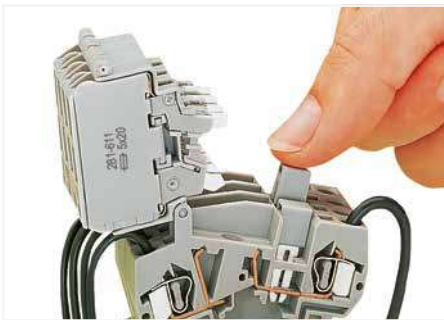

Commoning
Distributing current to several fuse-protected circuits via insulated push-in type jumpers.

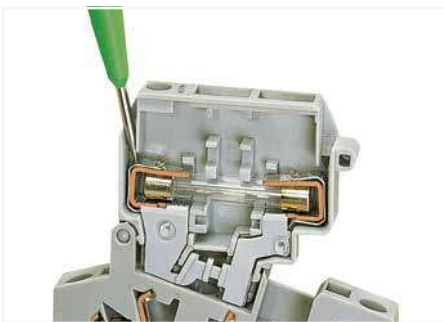
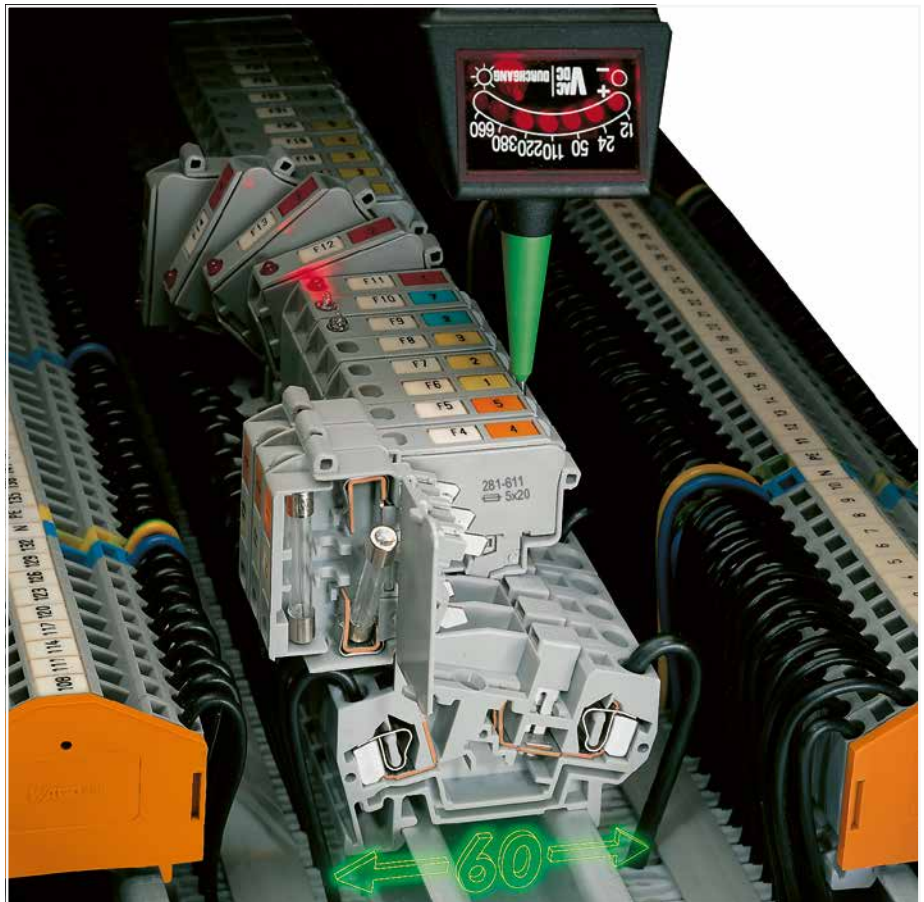

Voltage test, either at input or output with fuse holder in closed position (live)

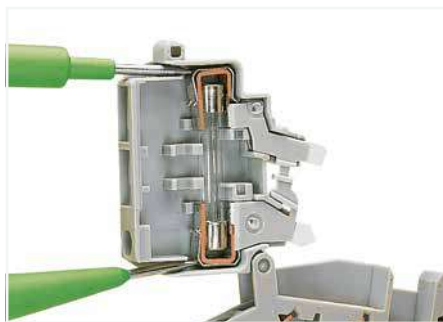

Through test with fuse holder in open position (no voltage)



Voltage test at input in the test slot of the current bar



CAGE CLAMP® terminates the following copper conductors: solid "s"



stranded "st"



fine-stranded "f-st", also with tinned single strands



Fuse replacement:
Easily removing a fuse by hand.



Fuse replacement:
Insert a new fuse and snap the cover closed.



Storing a spare fuse (fuse holder without blown fuse indication) for the types of fuses 5 x 20 mm, 5 x 25 mm and 5 x 30 mm.

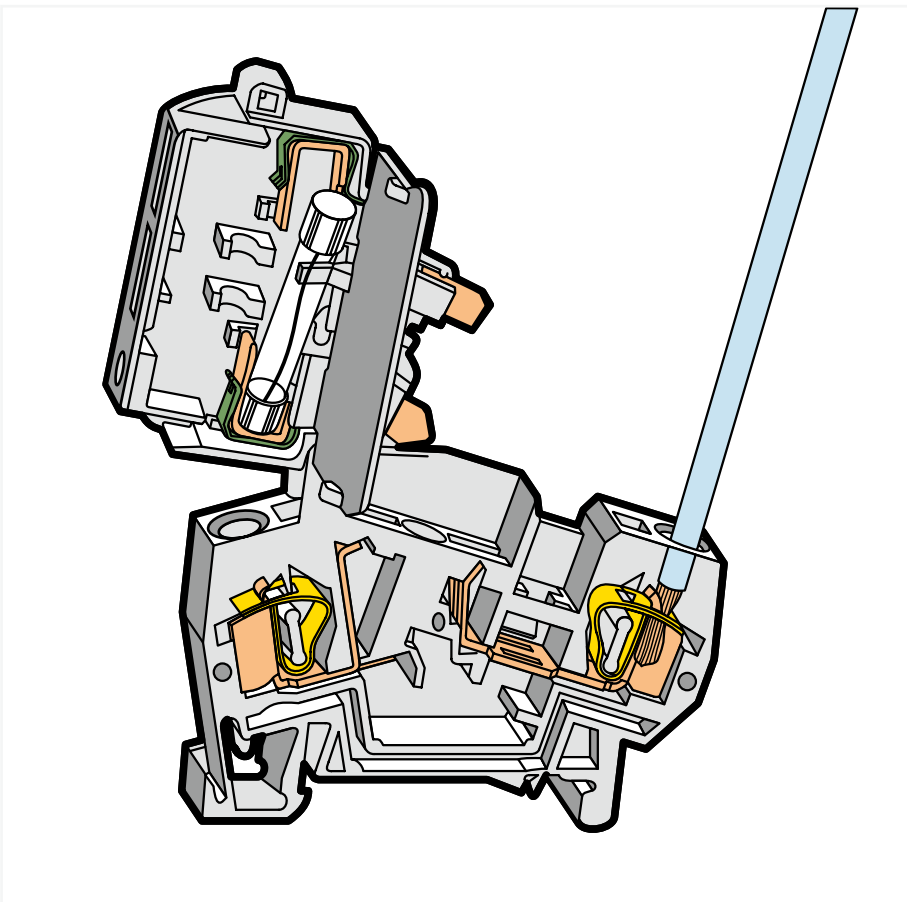

Touch-proof protection in all positions of the fuse holder

6



Fuse holder will remain safely locked open in vertical assemblies.



Testing voltage at the output via separate test slot.



Measuring current between jumper slot and separate test slot.



fine-stranded,
tip-bonded



fine-stranded,
with ferrule
(gastight crimped)



fine-stranded,
with pin terminal
(gastight crimped)

Fused Disconnect Terminal Block with a Pivoting Fuse Holder; for 5 x 20 mm, 5 x 25 mm and 5 x 30 mm Glass Cartridge Fuses 4 mm²; 281 Series

Technical Data	
0.08 ... 4 mm ²	28 ... 12 AWG
800 V / 8 kV / 3 ① ②	600 V, 10 A
I _N 10 A	600 V, 10 A [Ⓞ]
Terminal block width: 8 mm / 0.315 inch	
9 ... 10 mm / 0.35 ... 0.39 inch	

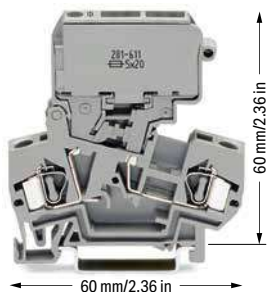

Dimensions (in mm):

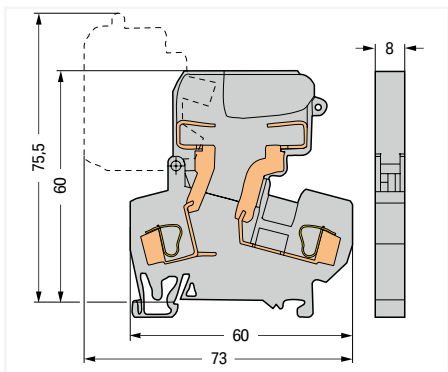

Fused disconnect terminal block with a pivoting fuse holder; for 5 x 20 mm glass cartridge fuse; without blown fuse indication
Electrical ratings are given by the fuse.

Color	Item No.	Pack. Unit
	281-611	50
	281-616	50

Technical Data	
0.08 ... 4 mm ²	28 ... 12 AWG
800 V / 8 kV / 3 ① ②	30 V, 10 A
I _N 10 A	230 V, 10 A [Ⓞ]
Terminal block width: 8 mm / 0.315 inch	
9 ... 10 mm / 0.35 ... 0.39 inch	



Dimensions (in mm):

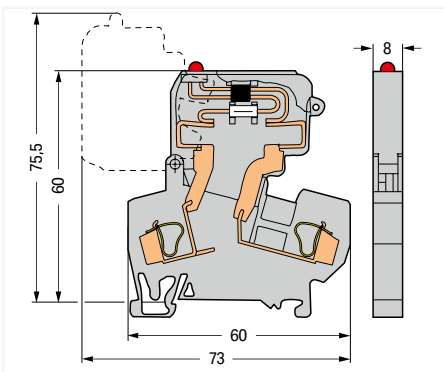

Fused disconnect terminal block with a pivoting fuse holder; for 5 x 20 mm glass cartridge fuse; with blown fuse indication by LED; gray
Electrical ratings are given by the fuse and blown fuse indication. Leakage current in case of a blown fuse: LED 6 mA

	Item No.	Pack. Unit
	15 ... 30 V 281-611/281-541	50
	30 ... 65 V 281-611/281-542	50

Technical Data	
0.08 ... 4 mm ²	28 ... 12 AWG
800 V / 8 kV / 3 ① ②	220 V, 10 A
I _N 10 A	230 V, 10 A [Ⓞ]
Terminal block width: 8 mm / 0.315 inch	
9 ... 10 mm / 0.35 ... 0.39 inch	

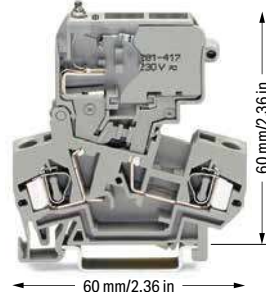

Dimensions (in mm):

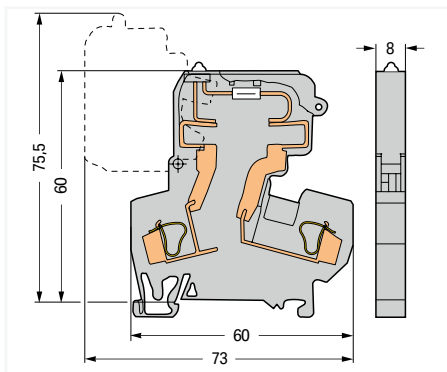

Fused disconnect terminal block with a pivoting fuse holder; for 5 x 20 mm glass cartridge fuse; with blown fuse indication by neon lamp; gray
Electrical ratings are given by the fuse and blown fuse indication. Leakage current in case of a blown fuse: Neon lamp < 0.4 mA

	Item No.	Pack. Unit
	230 V 281-611/281-417	50
	120 V 281-611/281-418	50

Fused disconnect terminal block with a pivoting fuse holder; for 5 x 25 mm glass cartridge fuse; without blown fuse indication
Electrical ratings are given by the fuse.

	281-612	50
--	---------	----

Fused disconnect terminal block with a pivoting fuse holder; for 5 x 25 mm glass cartridge fuse; with blown fuse indication by LED; gray
Electrical ratings are given by the fuse and blown fuse indication. Leakage current in case of a blown fuse: LED 6 mA

	15 ... 30 V 281-612/281-541	50
	30 ... 65 V 281-612/281-542	50

Fused disconnect terminal block with a pivoting fuse holder; for 5 x 25 mm glass cartridge fuse; with blown fuse indication by neon lamp; gray
Electrical ratings are given by the fuse and blown fuse indication. Leakage current in case of a blown fuse: Neon lamp < 0.4 mA

	230 V 281-612/281-417	50
	120 V 281-612/281-418	50

Fused disconnect terminal block with a pivoting fuse holder; for 5 x 30 mm glass cartridge fuse; without blown fuse indication
Electrical ratings are given by the fuse.

	281-622	50
--	---------	----

Fused disconnect terminal block with a pivoting fuse holder; for 5 x 30 mm glass cartridge fuse; with blown fuse indication by LED; gray
Electrical ratings are given by the fuse and blown fuse indication. Leakage current in case of a blown fuse: LED 6 mA

	15 ... 30 V 281-622/281-541	50
	30 ... 65 V 281-622/281-542	50

Fused disconnect terminal block with a pivoting fuse holder; for 5 x 30 mm glass cartridge fuse; with blown fuse indication by neon lamp; gray
Electrical ratings are given by the fuse and blown fuse indication. Leakage current in case of a blown fuse: Neon lamp < 0.4 mA

	230 V 281-622/281-417	50
	120 V 281-622/281-418	50

Glass cartridge fuses are available upon request.

Glass cartridge fuses are available upon request.

Glass cartridge fuses are available upon request.

6

Technical Data

0.08 ... 4 mm ²	28 ... 12 AWG
800 V / 8 kV / 3 ①	600 V, 16 A ②
I_N 16 A	
Terminal block width: 8 mm / 0.315 inch	
9 ... 10 mm / 0.35 ... 0.39 inch	

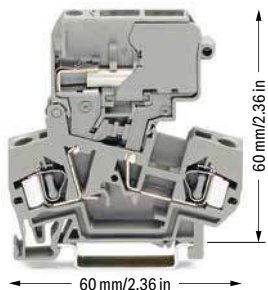

Dimensions (in mm):

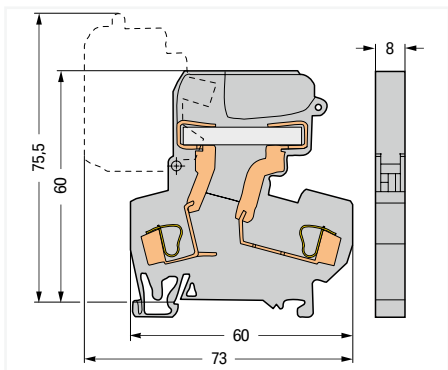

2-conductor disconnect terminal block

Color	Item No.	Pack. Unit
gray	281-624	100
orange	281-672	100

- ① 800 V = rated voltage
8 kV = rated impulse voltage
3 = pollution degree
(see Section 15)
 - ② Electrical ratings are given by the fuse (see page 344).
- Please observe the application notes:
Marking, from page 684
- Approvals and corresponding ratings,
visit www.wago.com

Accessories; 281 Series
Appropriate marking systems:
WMB/WMB Inline/WFB

End and intermediate plate; 2.5 mm thick

gray	281-309	100 (25)
orange	281-311	100 (25)

Adjacent jumper; insulated; $I_N = I_N$ terminal block

gray	281-402	200 (25)
------	---------	----------

Push-in type wire jumper; insulated; 0.75 mm² conductor cross section; I_N 9 A

L = 60 mm	249-125	100 (10)
L = 110 mm	249-126	100 (10)
L = 250 mm	249-127	100 (10)

Test plug adapter; 5 mm wide; for 4 mm Ø test plug; for 1.5 ... 4 mm² terminal blocks

gray	280-404	100 (25)
------	---------	----------

Test plug adapter; 6 mm wide; with CAGE CLAMP®; for 0.08 ... 2.5 mm²

I_N 24 A	281-407	100 (25)
------------	---------	----------

Interlocking link; mechanically locks multiple links; 1 m long

transparent	210-254	1
-------------	---------	---



Fused disconnect or disconnect terminal blocks with a width of 8 mm can be assembled adjacently. At the end of an assembly or if there is no adjacent fused disconnect or disconnect terminal block, an end or intermediate plate must be used.



All fuse holders are printed with correct fuse size.

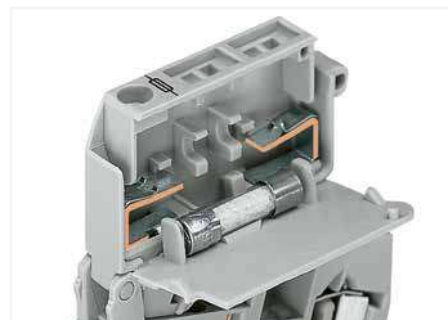

5 x 20 mm, 5 x 25 mm and 1/4" x 1" fuse holders are fitted with stops on the inside of the cover.

6

Fused Disconnect Terminal Block with a Pivoting Fuse Holder; for 1/4" x 1" and 1/4" x 1 1/4" Glass Cartridge Fuses 4 mm²; 281 Series

Technical Data	
0.08 ... 4 mm ²	28 ... 12 AWG
800 V / 8 kV / 3 ① ②	600 V, 10 A
I _N 10 A	600 V, 10 A
Terminal block width: 10 mm / 0.394 inch	
9 ... 10 mm / 0.35 ... 0.39 inch	

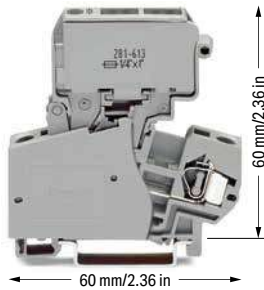

Dimensions (in mm):

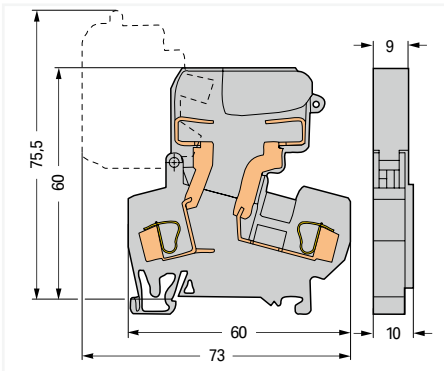

Fused disconnect terminal block with a pivoting fuse holder; for 1/4" x 1" glass cartridge fuse; without blown fuse indication
Electrical ratings are given by the fuse.

Color	Item No.	Pack. Unit
gray	281-613	50

Fused disconnect terminal block with a pivoting fuse holder; for 1/4" x 1 1/4" glass cartridge fuse; without blown fuse indication
Electrical ratings are given by the fuse.

gray	281-623	50
------	---------	----

Glass cartridge fuses are available upon request.

Technical Data	
0.08 ... 4 mm ²	28 ... 12 AWG
800 V / 8 kV / 3 ① ②	30 V, 10 A
I _N 10 A	30 V, 10 A
Terminal block width: 10 mm / 0.394 inch	
9 ... 10 mm / 0.35 ... 0.39 inch	



Dimensions (in mm):

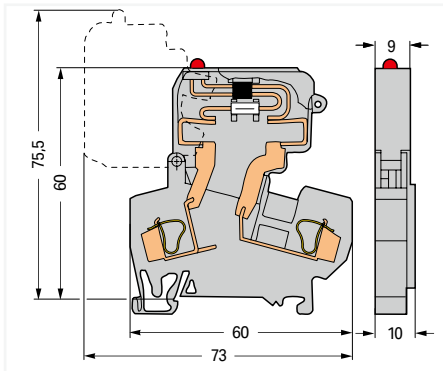

Fused disconnect terminal block with a pivoting fuse holder; for 1/4" x 1" glass cartridge fuse; with blown fuse indication by LED; gray
Electrical ratings are given by the fuse and blown fuse indication. Leakage current in case of a blown fuse: LED 6 mA

	Item No.	Pack. Unit
15 ... 30 V	281-613/281-541	50
30 ... 65 V	281-613/281-542	50

Fused disconnect terminal block with a pivoting fuse holder; for 1/4" x 1 1/4" glass cartridge fuse; with blown fuse indication by LED; gray
Electrical ratings are given by the fuse and blown fuse indication. Leakage current in case of a blown fuse: LED 6 mA

15 ... 30 V	281-623/281-541	50
30 ... 65 V	281-623/281-542	50

Glass cartridge fuses are available upon request.

Technical Data	
0.08 ... 4 mm ²	28 ... 12 AWG
800 V / 8 kV / 3 ① ②	220 V, 10 A
I _N 10 A	100 V, 10 A
Terminal block width: 10 mm / 0.394 inch	
9 ... 10 mm / 0.35 ... 0.39 inch	



Dimensions (in mm):

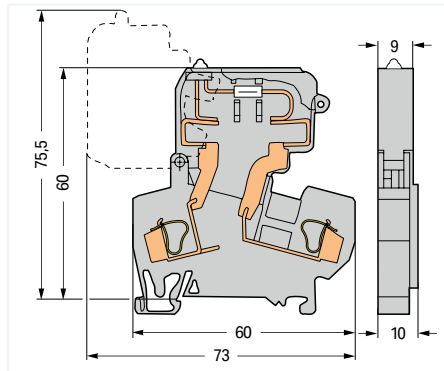

Fused disconnect terminal block with a pivoting fuse holder; for 1/4" x 1" glass cartridge fuse; with blown fuse indication by neon lamp; gray
Electrical ratings are given by the fuse and blown fuse indication. Leakage current in case of a blown fuse: Neon lamp < 0.4 mA

	Item No.	Pack. Unit
230 V	281-613/281-417	50
120 V	281-613/281-418	50

Fused disconnect terminal block with a pivoting fuse holder; for 1/4" x 1 1/4" glass cartridge fuse; with blown fuse indication by neon lamp; gray
Electrical ratings are given by the fuse and blown fuse indication. Leakage current in case of a blown fuse: Neon lamp < 0.4 mA

230 V	281-623/281-417	50
120 V	281-623/281-418	50

Glass cartridge fuses are available upon request.

- ❶ 800 V = rated voltage
8 kV = rated impulse voltage
3 = pollution degree
(see Section 15)
 - ❷ Electrical ratings are given by the fuse (see page 344).
- Please observe the application notes:
Marking, from page 684
- Approvals and corresponding ratings,
visit www.wago.com



An intermediate plate is supplied with all 10 mm wide fused disconnect terminal blocks. At the end of an assembly or if there is no adjacent fused disconnect terminal block, an end or intermediate plate must be used.

Accessories; 281 Series

Appropriate marking systems:
WMB/WMB Inline/WFB

End and intermediate plate; 2.5 mm thick



gray	281-309	100 (25)
orange	281-311	100 (25)

Adjacent jumper; insulated; I_N = I_N terminal block



gray	281-402	200 (25)
------	---------	----------

Push-in type wire jumper; insulated; 0.75 mm² conductor cross section; I_N 9 A



L = 60 mm	249-125	100 (10)
L = 110 mm	249-126	100 (10)
L = 250 mm	249-127	100 (10)

Test plug adapter; 5 mm wide; for 4 mm Ø test plug; for 1.5 ... 4 mm² terminal blocks



gray	280-404	100 (25)
------	---------	----------

Test plug adapter; 6 mm wide; with CAGE CLAMP®; for 0.08 ... 2.5 mm²



I _N 24 A	281-407	100 (25)
---------------------	---------	----------

Interlocking link; mechanically locks multiple links; 1 m long



transparent	210-254	1
-------------	---------	---



Each fuse holder features two marker slots for custom WMB Multi markers (example shows 8 mm wide terminal blocks).



Ganging several fuse holders with an interlocking link (example shows 8 mm wide terminal blocks).

Fuse Plug on Carrier Terminal Block 4 mm² 281 Series

Technical Data

250 V / I_N 6,3 A ④
Plug width: 6 mm / 0.236 inch



281-511

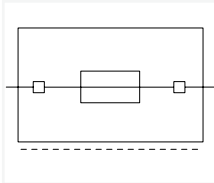

Fuse plug with pull-tab; for 5 x 20 mm and 5 x 25 mm glass cartridge fuses; 6 mm wide
Electrical ratings are given by the fuse.

Color	Item No.	Pack. Unit
○ gray	281-511	50

Fuse plug with pull-tab; for 5 x 20 mm and 5 x 25 mm glass cartridge fuses; with hole for one LED (for self-assembly); 6 mm wide; gray
Electrical ratings are given by the fuse and blown fuse indication.

○ gray	281-512	50
--------	---------	----

Technical Data

250 V / I_N 6,3 A ④
Plug width: 6 mm / 0.236 inch



281-512/281-501

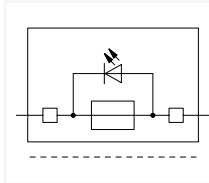

Fuse plug with pull-tab; for 5 x 20 mm and 5 x 25 mm glass cartridge fuses; with LED; 24 VAC/DC; 6 mm wide
Electrical ratings are given by the fuse and blown fuse indication. Leakage current in case of a blown fuse: LED 5 ... 20 mA

Color	Item No.	Pack. Unit
○ gray	281-512/281-501	50

Fuse plug with pull-tab; for 5 x 20 mm and 5 x 25 mm glass cartridge fuses; with neon lamp; 120 VAC/DC; 6 mm wide
Electrical ratings are given by the fuse and blown fuse indication. Leakage current in case of a blown fuse: Neon lamp < 0.4 mA

○ gray	281-512/281-418	50
--------	-----------------	----

Fuse plug with pull-tab; for 5 x 20 mm and 5 x 25 mm glass cartridge fuses; with neon lamp; 230 VAC/DC; 6 mm wide
Electrical ratings are given by the fuse and blown fuse indication. Leakage current in case of a blown fuse: Neon lamp < 0.4 mA

○ gray	281-512/281-417	50
--------	-----------------	----

Accessories; for fuse plugs

Appropriate marking systems: 4 mm wide WSB for plug and WMB terminal block

2-conductor carrier terminal block;
0.08 ... 4 mm² / 28 ... 12 AWG
Terminal block width: 6 mm / 0.236 inch

gray	281-916	50
------	---------	----

End and intermediate plate; 2.5 mm thick

orange	281-329	100 (25)
gray	281-328	100 (25)

3-conductor carrier terminal block;
0.08 ... 4 mm² / 28 ... 12 AWG
Terminal block width: 6 mm / 0.236 inch

gray	281-610	50
------	---------	----

End and intermediate plate; 2.5 mm thick

orange	281-326	100 (25)
gray	281-324	100 (25)

4-conductor carrier terminal block;
0.08 ... 4 mm² / 28 ... 12 AWG
Terminal block width: 6 mm / 0.236 inch

gray	281-656	50
------	---------	----

End and intermediate plate; 2.5 mm thick

orange	281-335	100 (25)
gray	281-334	100 (25)

Wire commoning chain; insulated; 50 connections; I_N 8 A

black	210-103	5
-------	---------	---

Wire commoning chain; insulated; 50 connections; I_N 8 A

blue	210-123	5
------	---------	---

④ Electrical ratings are given by the fuse or LED nominal voltage (see page 387).

Please observe the application notes:
Marking, from page 684

Approvals and corresponding ratings,
visit www.wago.com

Accessories; for fuse plugs

Appropriate marking systems:
WMB/WMB Inline

Comb-style jumper bar; insulated; I_N = I_N of terminal block

2-way	281-482	100 (25)
3-way	281-483	100 (25)
5-way	281-485	100 (25)
10-way	281-490	50 (25)

Alternate comb-style jumper bar; insulated; I_N = I_N of terminal block

2-way	281-492	100 (25)
-------	---------	----------

Operating tool; insulated

2-way	280-432	1
3-way	280-433	1
5-way	281-440	1

Shorting link; 5 x 20 mm; allows the fuse plug to be used as a disconnect plug

I _N 6.3 A	281-503	250 (25)
----------------------	---------	----------

WSB marking card; white, 10 strips with 10 markers/card; 4 mm wide WSB markers

plain	209-701	5
-------	---------	---

WSB marking card; plain; 10 strips with 10 markers/card; 4 mm wide WSB markers

yellow	209-701/000-002	5
red	209-701/000-005	5
blue	209-701/000-006	5
gray	209-701/000-007	5
orange	209-701/000-012	5
light green	209-701/000-017	5
green	209-701/000-023	5
violet	209-701/000-024	5

WSB marking card; for fuse plugs (281-5...); white; 4 mm wide WSB markers

F1, ..., F10 (10x)	209-787	5
F11, ..., F20 (10x)	209-700/209-124	5
F21, ..., F30 (10x)	209-700/209-125	5
F31, ..., F40 (10x)	209-700/209-126	5
F41, ..., F50 (10x)	209-700/209-127	5

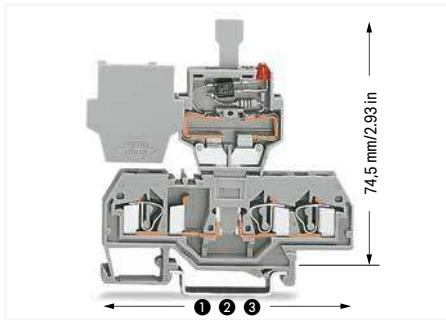

Length of carrier terminal blocks with a fuse plug:

- ❶ 59 mm / 2.32 inch for 281-916
- ❷ 73.5 mm / 2.89 inch for 281-610
- ❸ 86 mm / 3.39 inch for 281-656

Terminal blocks with side marking, visit www.wago.com



Using fuse plugs with rail-mount terminal blocks for control circuit protection is highly advantageous because the function and wiring levels are separated:

- No additional cost for assembly and wiring
- No risk of accidental contact with live parts when disconnecting the fuse plug
- The fuse plug is completely separated from the carrier terminal block when replacing a fuse – away from current carrying parts
- The fuse plug can be removed by service personnel
- No unintentional reclosing of the circuit by another person
- Quickly exchange a fuse by using a prepared "stand-by plug"

Fuse plug features for quick and safe applications:

- Optional LED indicates blown fuse
- Top-of-unit marking slot provides clear carrier terminal block identification
- Two test slots with touch contacts
- Terminal blocks/plugs provide high-density wiring in a width of just 6 mm
- May be used as a disconnect plug in combination with a shorting link

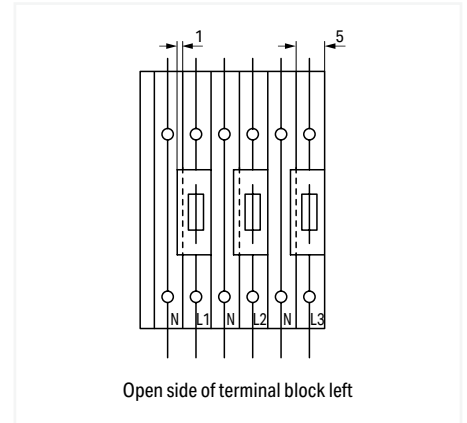

When a corresponding neutral circuit is adjacent to the fuse plug, a 5 mm wide space-saving terminal block may be used, as a 6 mm fuse plug may overlap the terminal block (see diagram).

For example, 5 mm (0.197 inch) wide carrier terminal blocks can be used with an end plate.

Fuse Plug on Carrier Terminal Block 2.5 mm² 280 Series

Technical Data

125 V / I_N 5 A
Plug width: 5 mm / 0.197 inch



280-850

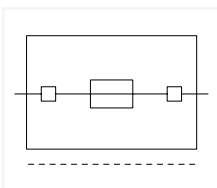

Fuse plug; with soldered miniature fuse; 5 mm wide; gray
Electrical ratings are given by the fuse.

	Item No.	Pack. Unit
○ 250 mA FF	280-850	100
○ 500 mA FF	280-852	100
○ 1 A FF	280-854	100
○ 2 A FF	280-856	100

Technical Data

125 V / I_N 5 A
Plug width: 5 mm / 0.197 inch



280-850/281-413

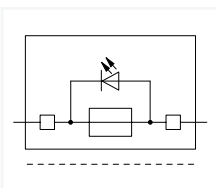

Fuse plug; with soldered miniature fuse; with additional indicator lamp; red LED; 15 ... 30 VDC; 5 mm wide; gray
Electrical ratings are given by the fuse and blown fuse indication. Leakage current in case of a blown fuse: LED 5 ... 20 mA

	Item No.	Pack. Unit
○ 250 mA FF	280-850/281-413	100
○ 500 mA FF	280-852/281-413	100
○ 1 A FF	280-854/281-413	100
○ 2 A FF	280-856/281-413	100

*12 AWG: THHN, THWN

Please observe the application notes:
Marking, from page 684

Approvals and corresponding ratings,
visit www.wago.com

Accessories; for fuse plugs

Appropriate marking system:
WMB

WMB Inline, plain; 1,500 WMB markers (5 mm)/reel;
5 ... 5.2 mm stretchable

	white	2009-115	1
--	-------	----------	---

WMB marking card; white; 10 strips with 10 markers/card;
5 ... 5.2 mm stretchable

	plain	793-5501	5
--	-------	----------	---

6

Accessories; for fuse plugs

Appropriate marking system: WMB

2-conductor carrier terminal block;
0.08 ... 2.5 mm² / 28 ... 12 AWG*
Terminal block width: 5 mm / 0.197 inch



gray	280-916	100
------	---------	-----

End and intermediate plate; 2.5 mm thick



orange	280-309	100 (25)
gray	280-308	100 (25)

3-conductor carrier terminal block;
0.08 ... 2.5 mm² / 28 ... 12 AWG*
Terminal block width: 5 mm / 0.197 inch



gray	280-610	100
------	---------	-----

End and intermediate plate; 2.5 mm thick



orange	280-326	100 (25)
gray	280-324	100 (25)

4-conductor carrier terminal block;
0.08 ... 2.5 mm² / 28 ... 12 AWG*
Terminal block width: 5 mm / 0.197 inch



gray	280-816	100
------	---------	-----

End and intermediate plate; 2.5 mm thick



orange	280-315	100 (25)
gray	280-314	100 (25)

Comb-style jumper bar; insulated; I_N = I_N of terminal block



2-way	280-482	200 (25)
3-way	280-483	200 (25)

Comb-style jumper bar; insulated; I_N = I_N of terminal block



10-way	280-490	50 (25)
--------	---------	---------

Alternate comb-style jumper bar; insulated; I_N = I_N of terminal block



2-way	280-492	200 (25)
-------	---------	----------

Operating tool; insulated



2-way	280-432	1
3-way	280-433	1

Operating tool; insulated



10-way	280-440	1
--------	---------	---

Wire commoning chain; insulated; 50 connections; I_N 8 A



black	210-103	5
-------	---------	---

Wire commoning chain; insulated; 50 connections; I_N 8 A



blue	210-123	5
------	---------	---

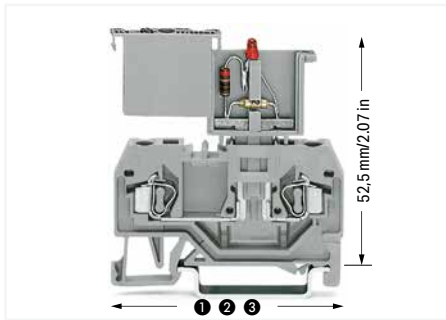

Length of carrier terminal blocks with a fuse plug:

- ① 53 mm / 2.09 inch for 280-916
- ② 64 mm / 2.52 inch for 280-610
- ③ 75 mm / 2.95 inch for 280-816

Terminal blocks with side marking, visit www.wago.com



Using fuse plugs with rail-mount terminal blocks (280/281 and 769 Series) for control circuit protection is highly advantageous because the function and wiring levels are separated:

- No additional cost for assembly and wiring
- No risk of accidental contact with live parts when disconnecting the fuse plug
- Quick plug replacement in case of a blown fuse
- The fuse plug can be removed by service personnel
- No unintentional reclosing of the circuit by another person
- Terminal blocks/plugs provide ultra high-density wiring in a width of just 5 mm
- Optional LED indicates blown fuse

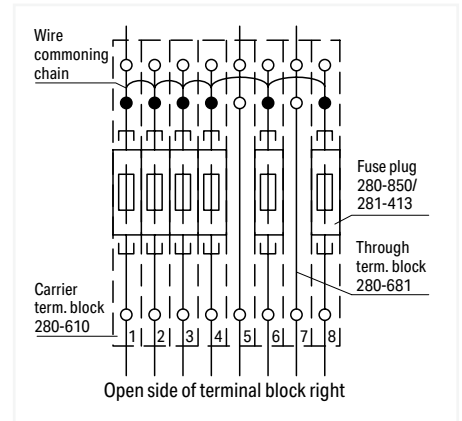

Fuse protection of individual outputs – supply via wire commoning chain

Fuse Terminal Block for 10 x 38 mm (1 3/32" x 1 1/2") Cylindrical Fuses and Class CC Fuses 16 mm²; 811 Series

Technical Data	
2.5 ... 16 mm ²	14 ... 6 AWG
1000 VDC, 32 A	1000 VDC, 30 A [Ⓢ]

Terminal block width: 17.5 mm / 0.689 inch
 12 ... 13 mm / 0.47 ... 0.51 inch



Technical Data	
2.5 ... 16 mm ²	14 ... 6 AWG
690 VAC, 32 A	750 VAC, 30 A [Ⓢ]
1000 VDC, 32 A	600 VAC, 30 A [Ⓢ]
	1000 VDC, 30 A [Ⓢ] Ⓢ

Terminal block width: 17.5 mm / 0.689 inch
 12 ... 13 mm / 0.47 ... 0.51 inch



Technical Data	
2.5 ... 16 mm ²	14 ... 6 AWG
32 A	600 V, 30 A [Ⓢ]
	600 V, 30 A [Ⓢ]

Terminal block width: 17.5 mm / 0.689 inch
 12 ... 13 mm / 0.47 ... 0.51 inch



Dimensions (in mm):

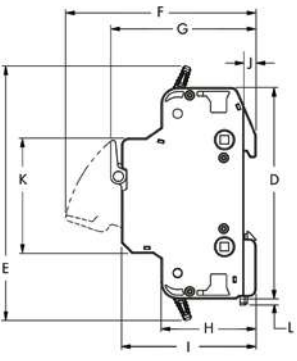

Dimension	mm (inch)
A	17.3 (0.68)
B	34.6 (1.36)
C	51.9 (2.04)
D	87 (3.43)
E	104.9 (4.13)
F	78.3 (3.08)
G	59.7 (2.35)
H	39 (1.54)
I	55.2 (2.17)
J	5 (0.2)
K	47.4 (1.87)
L	2.5 (0.1)

Fuse terminal block for 10 x 38 mm (1 3/32" x 1 1/2") cylindrical fuses; for photovoltaic applications; without blown fuse indication; for DIN-35 rail per EN 60715; light gray

Pole No.	Item No.	Pack. Unit
○ 1-pole	811-316	12

Fuse terminal block for 10 x 38 mm (1 3/32" x 1 1/2") cylindrical fuses; without blown fuse indication; for DIN-35 rail per EN 60715; light gray

Pole No.	Item No.	Pack. Unit
○ 1-pole	811-310	12
○ 2-pole	811-320	6
○ 3-pole	811-330	4

Fuse terminal block for class CC fuses; without blown fuse indication; for DIN-35 rail per EN 60715; light gray

Pole No.	Item No.	Pack. Unit
○ 1-pole	811-410	12
○ 2-pole	811-420	6
○ 3-pole	811-430	4

Fuse terminal block for 10 x 38 mm (1 3/32" x 1 1/2") cylindrical fuses; for photovoltaic applications; with blown fuse indication; 230 ... 1000 VDC; for DIN-35 rail; light gray

○ 1-pole	811-317	12
----------	---------	----

Fuse terminal block for 10 x 38 mm (1 3/32" x 1 1/2") cylindrical fuses; with blown fuse indication; 90 ... 600 VAC; 115 ... 600 VDC; for DIN-35 rail; light gray

○ 1-pole	811-311	12
○ 2-pole	811-321	6
○ 3-pole	811-331	4

Fuse terminal block for class CC fuses; with blown fuse indication; 90 ... 600 VAC; 115 ... 600 VDC; for DIN-35 rail; light gray

○ 1-pole	811-411	12
○ 2-pole	811-421	6
○ 3-pole	811-431	4

Fuse terminal block for 10 x 38 mm (1 3/32" x 1 1/2") cylindrical fuses; with blown fuse indication; 24 VDC; for DIN-35 rail; light gray

○ 1-pole	811-314	12
----------	---------	----

Fuse terminal block for class CC fuses; with blown fuse indication; 24 VDC; for DIN-35 rail; light gray

○ 1-pole	811-414	12
----------	---------	----

Accessories; 811 Series

Appropriate marking systems: WMB/Marking strips

Supply module; 35 mm ² ; 600 VAC; 1000 VDC	Item No.	Pack. Unit
	811-471	16(4)

Coupling kit; for 12 poles	Item No.	Pack. Unit
	811-612	1

WMB Inline, plain; 1,500 WMB markers (5 mm)/reel; 5 ... 5.2 mm stretchable	Item No.	Pack. Unit
white	2009-115	1

Test plug; with 500 mm cable; 2 mm Ø; max. 42 V	Item No.	Pack. Unit
red 	210-136	50

Marker carrier; for POWER CAGE CLAMP 35/50/95 mm ² ; 10.4 mm wide	Item No.	Pack. Unit
gray 	285-442	25

WMB marking card; white; 10 strips with 10 markers/card; stretchable 5 ... 5.2 mm	Item No.	Pack. Unit
plain 	793-5501	5

Cylindrical fuses are not offered by WAGO. Temperature range: -35 ... +85 °C
Electrical ratings are given by the fuse and blown fuse indication.

Please observe the application notes:
Marking, from page 684

Approvals and corresponding ratings,
visit www.wago.com

Accessories; 811 Series

Appropriate marking systems:
WMB/Marking strips

Push-in type jumper bar; insulated; I_n 63 A



2-way	811-472	50 (10)
3-way	811-473	40 (10)
4-way	811-474	40 (10)
5-way	811-475	40 (10)
6-way	811-476	30 (10)
7-way	811-477	20 (10)
8-way	811-478	20 (10)
9-way	811-479	20 (10)
10-way	811-480	20 (10)
11-way	811-481	20 (10)
12-way	811-482	20 (10)

Twin ferrule only for 811 Series; insulated; 12 mm long



Sleeve for 2 x 2.5 mm ² / 14 AWG	216-545	100
Sleeve for 2 x 4 mm ² / 12 AWG	216-546	100
Sleeve for 2 x 6 mm ² / 10 AWG	216-547	100



CAGE CLAMP® connection
Inserting a conductor.
Opening the clamping unit via integrated lever.



Terminating ferruled conductors up to 10 mm² (8 AWG).



Inserting a fuse.



Removing a terminal block from the DIN-rail.



Open and close lever via operating tool.



Marker carriers (285-442) for continuous marking strips



WMB marking location for convenient identification



Jumper bar for quick and convenient commoning



Creating a 2- or 3-pole fuse terminal block via coupling kit.

Fused Disconnect Terminal Block; for 10/14 x 85 mm Cylindrical Fuses 16 mm²; 811 Series

Technical Data

2.5 ... 16 mm² | 14 ... 6 AWG

1500 VDC, 32 A

Terminal block width: 22.3 mm / 0.878 inch

12 ... 13 mm / 0.47 ... 0.51 inch

Cylindrical fuses are not offered by WAGO. Temperature range: -35 ... +85 °C
Electrical ratings are given by the fuse and blown fuse indication.

Approvals and corresponding ratings, visit www.wago.com



2-conductor fused disconnect terminal block; with a pivoting fuse holder; with test point; for 10/14 x 85 mm cylindrical fuses; for photovoltaic applications; for DIN-35 rail; light gray

Pole No.	Item No.	Pack. Unit
○ 1-pole	811-1316	12

Opening and closing lever via operating tool.

6



Removing a terminal block from the DIN-rail.



Inserting a fuse.



CAGE CLAMP® connection
Inserting a conductor.
Opening the clamping unit via integrated lever.



Terminating ferruled conductors up to 10 mm² (8 AWG).

6

Application Notes on Terminal Blocks for Glass Cartridge Fuses

Terminal Blocks for Glass Cartridge Fuses Tested per IEC or EN 60947-7-3/VDE 0611-6

When selecting glass cartridge fuses, make sure that the maximum power loss listed below is not exceeded.

The power loss is determined according to IEC or EN 60947-7-3/VDE 0611-6 at 23°C.

The temperature rise of the terminal blocks must be checked according to their application and mounting.

Higher ambient temperatures represent an additional impact on fuse cartridges. Therefore, in such applications, the rated current must be reduced if necessary.

More details are available from the manufacturers.

Glass Cartridge Fuses (5 x 20 mm)

Series Item No.	Overload and Short-Circuit Protection		Short-Circuit Protection Only	
	Individual Arrangement	Block Arrangement	Individual Arrangement	Block Arrangement
Fuse terminal blocks (with screw cap), front-entry (5 x 20 mm)				
282-122 282-124	2.5 W	2.5 W	4 W	4 W
Fused disconnect terminal block with a pivoting fuse holder for glass cartridge fuses (5 x 20 mm)				
281-611 281-616 281-611/281-541 281-611/281-542 281-611/281-417 281-611/281-418	2.5 W	1.6 W	4 W	4 W
Fuse plugs for glass cartridge fuses (5 x 20 mm)				
281-511 281-512 281-512/281-501 281-512/281-418 281-512/281-417	2.5 W	1.6 W	4 W	4 W

Glass Cartridge Fuses (6.3 x 32 mm)

Series Item No.	Overload and Short-Circuit Protection		Short-Circuit Protection Only	
	Individual Arrangement	Block Arrangement	Individual Arrangement	Block Arrangement
Fuse terminal blocks (with screw cap), front-entry (1/4" x 11/4" ≈ 6.3 x 32 mm)				
282-128 282-128/281-418 282-128/281-413 282-128/281-417	2.5 W	2.5 W	4 W	4 W
Fused disconnect terminal block with a pivoting fuse holder for glass cartridge fuses (1/4" x 11/4" ≈ 6.3 x 32 mm)				
281-623 281-623/281-541 281-623/281-542 281-623/281-417 281-623/281-418	2.5 W	1.6 W	4 W	2.5 W

Individually arranged fuse terminal blocks

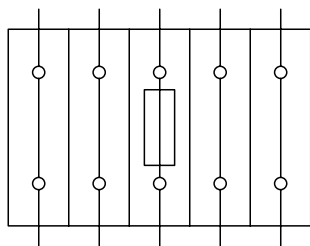

Terminal block assembly including one fuse terminal block and through terminal blocks

Fuse terminal block in a group

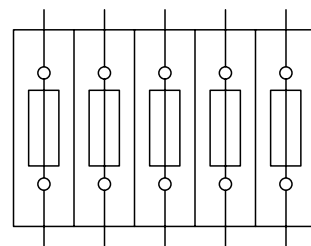

Terminal block assembly including five fuse terminal blocks

Sensor Terminal Blocks and Actuator Terminal Blocks

280 Series

Description and Installation

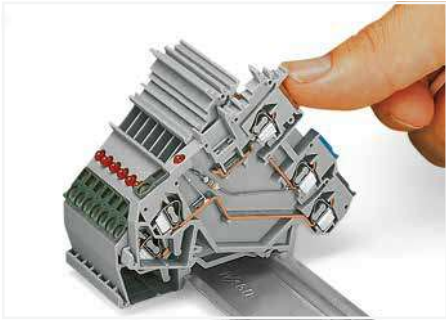

Snapping a terminal block onto the DIN-rail. Terminal blocks with a grounding foot automatically establish a direct contact to the rail.

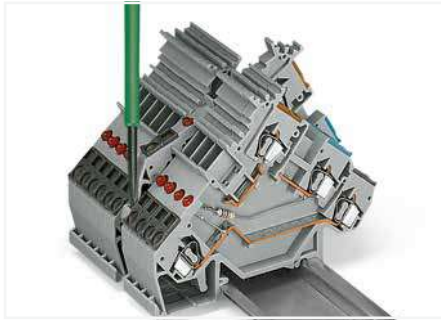

Removing a terminal block from the DIN-rail. Notice: Remove jumper contacts first.

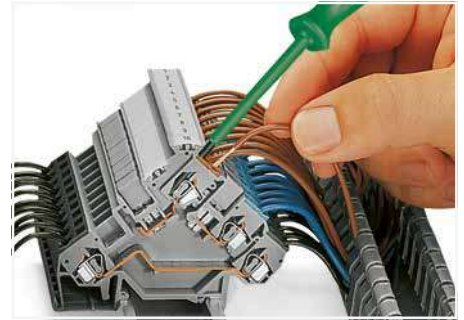

CAGE CLAMP® connection
Inserting a conductor via straight operating tool (210-720).

6

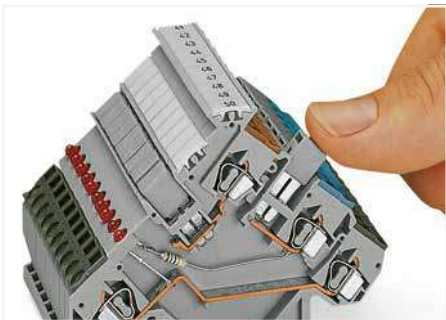

Commoning using an adjacent jumper (280-402). Push jumper down until fully inserted.

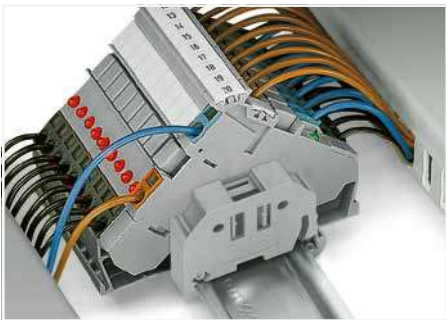
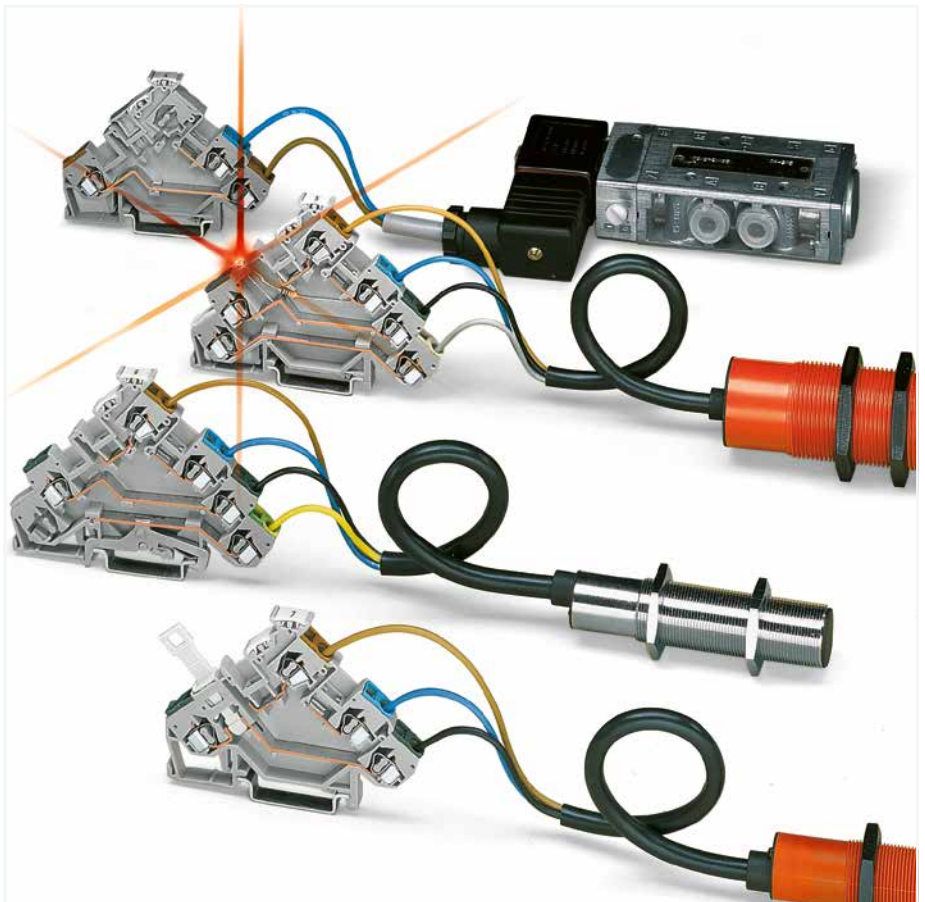

Sensor terminal blocks
Power supply from control panel side

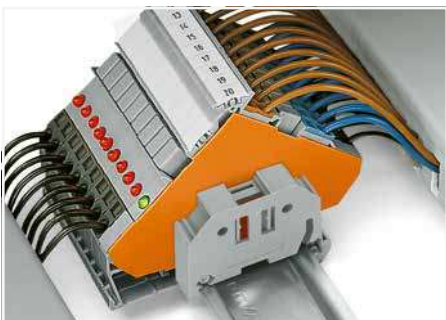

Sensor terminal blocks
Power supply from sensor side

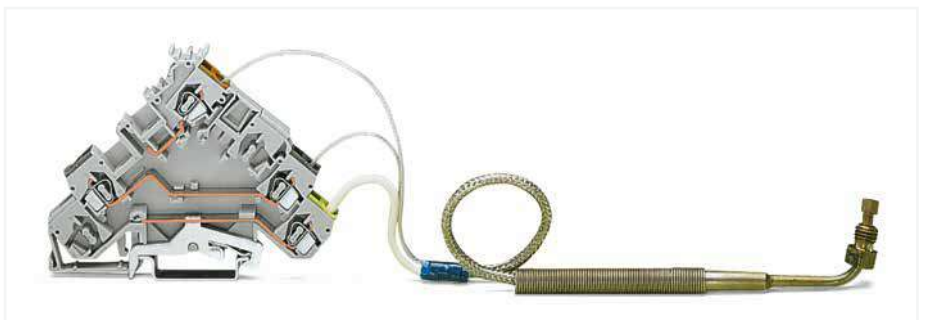

Actuator terminal block; with shield connection; with a thermocouple



CAGE CLAMP® terminates the following copper conductors: solid "s"



stranded "st"



fine-stranded "f-st", also with tinned single strands

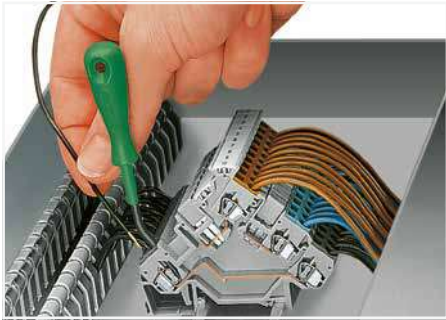

CAGE CLAMP® connection
Inserting a conductor via angled operating tool (210-658).



Labeling via WMB Multi Marking System.

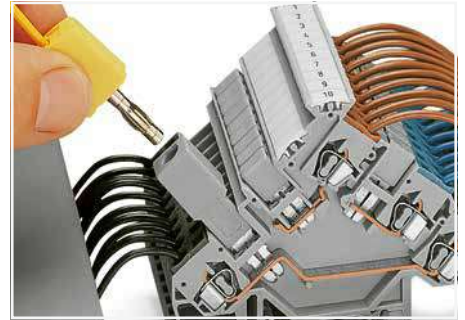

Testing via banana plug and test plug adapter (209-170).

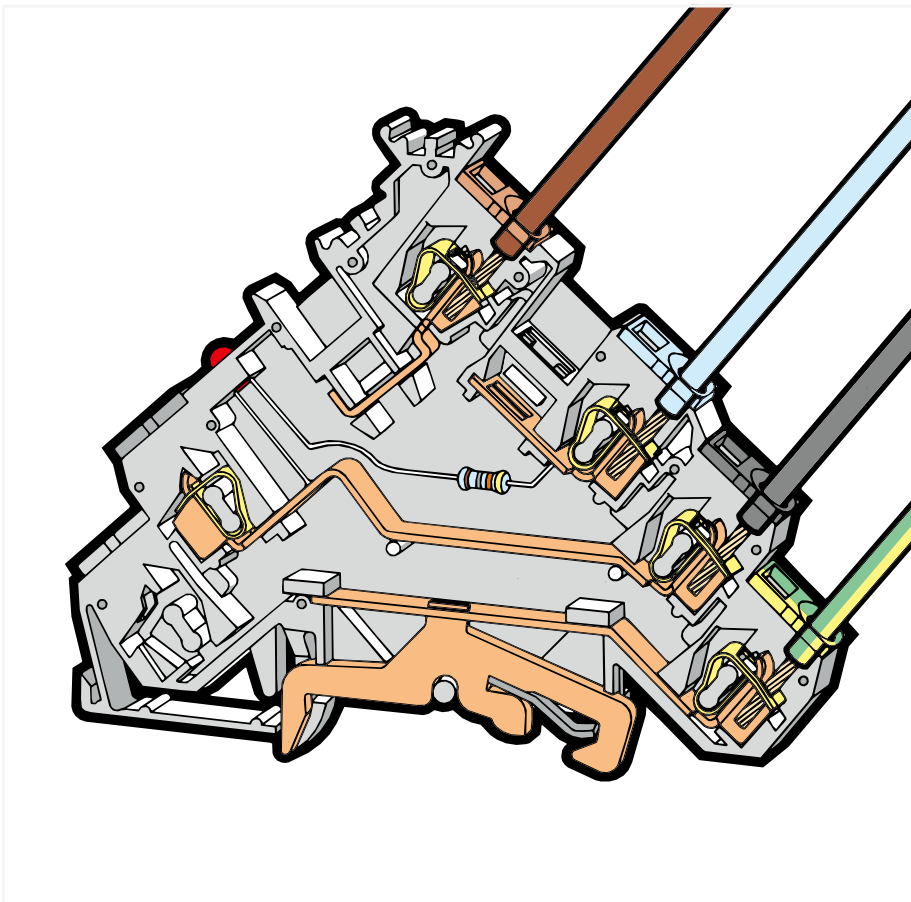

Testing via voltage tester directly on the current bar.



Actuator terminal blocks with fuse holders (281-511) – intermediate plates are required!



Actuator terminal block with thermocouple

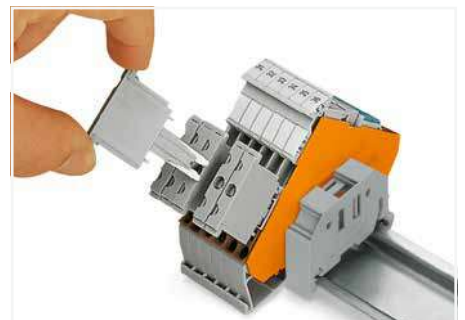

Actuator terminal blocks with component plugs (280 801)



fine-stranded,
tip-bonded



fine-stranded,
with ferrule
(gastight crimped)



fine-stranded,
with pin terminal
(gastight crimped)

Sensor terminal block; for 3-conductor sensors 2.5 mm²; 280 Series

Technical Data	
0.08 ... 2.5 mm ²	28 ... 12 AWG*
400 V / 6 kV / 3 ⚡	300 V, 15 A ⚡
I _N 20 A	300 V, 15 A Ⓜ
Terminal block width: 5 mm / 0.197 inch	
8 ... 9 mm / 0.31 ... 0.35 inch	

Technical Data	
0.08 ... 2.5 mm ²	28 ... 12 AWG*
250 V / 4 kV / 3 ⚡	300 V, 6 A ⚡
I _N 6 A	300 V, 15 A Ⓜ
Terminal block width: 5 mm / 0.197 inch	
8 ... 9 mm / 0.31 ... 0.35 inch	

Technical Data	
0.08 ... 2.5 mm ²	28 ... 12 AWG*
400 V / 6 kV / 3 ⚡	300 V, 10 A ⚡
I _N 10 A	300 V, 15 A Ⓜ
Terminal block width: 5 mm / 0.197 inch	
8 ... 9 mm / 0.31 ... 0.35 inch	

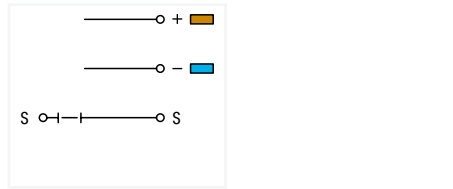
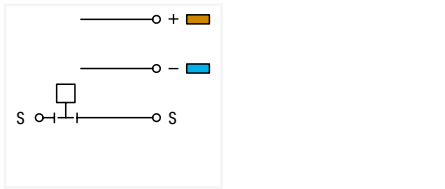
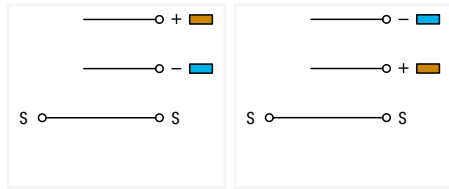
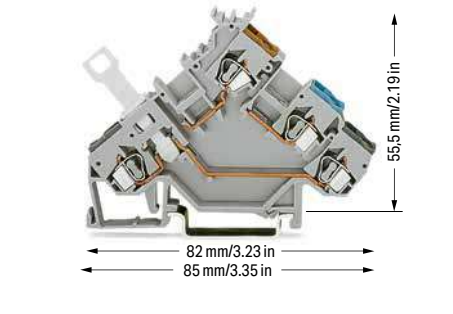
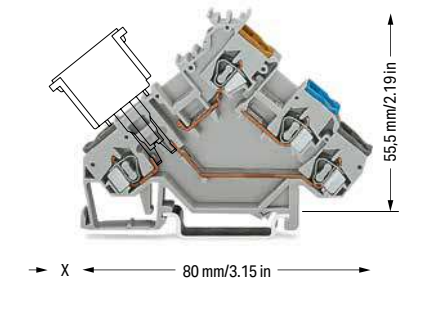
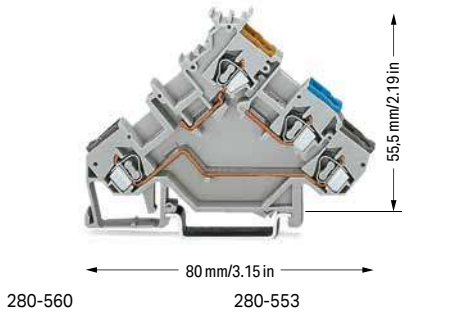

Sensor terminal block		
Color	Item No.	Pack. Unit
○ gray	280-560	50
○ gray	280-553	50

Sensor terminal block; for component plugs		
Color	Item No.	Pack. Unit
○ gray	280-561 Ⓜ	50

Sensor disconnect terminal block; for signal interruption		
Color	Item No.	Pack. Unit
○ gray	280-563	50

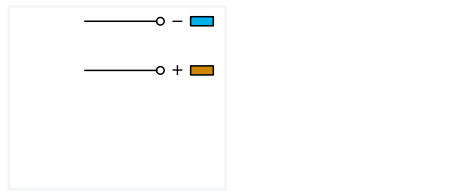
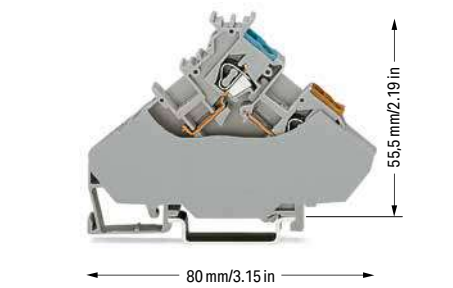
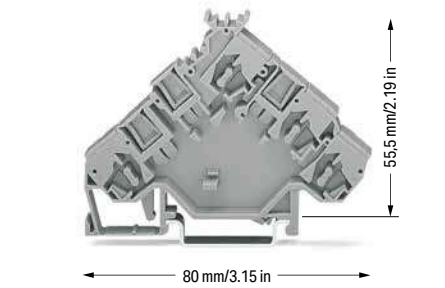
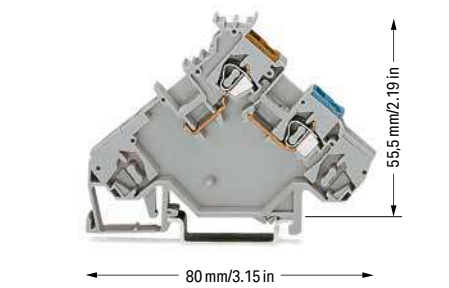

Sensor supply terminal block; power supply from sensor side		
Color	Item No.	Pack. Unit
○ gray	280-564	10

Spacer; same profile as 3-conductor sensor terminal blocks or corresponding actuator terminal blocks Spacers with the same profile clearly differentiate between sensor or actuator terminal groups, e.g., of different power supply.		
Color	Item No.	Pack. Unit
○ gray	280-559	50

Sensor supply terminal block; power supply from control panel side; with end plate Terminal block width: 6 mm / 0.236 inch		
Color	Item No.	Pack. Unit
○ gray	280-567	20

Technical Data	
400 V / 6 kV / 3	I _N 20 A

6

- *12 AWG: THHN, THWN
 - ❶ 400 V / 250 V = rated voltage
6 kV / 4 kV = rated impulse voltage
3 = pollution degree
(see Section 15)
 - ❷ Electrical ratings are given by the fuse plug or empty component plug housing.
 - ❸ Empty component plug housings, see Full Line Catalog, Interface Modules, Volume 4
x = 12 mm/0.472 inch
Fuse plug (280-850), see page 380
x = 20 mm/0.787 inch
- Please observe the application notes:
Insulation stop, page 425
Marking, from page 684
- Approvals and corresponding ratings,
visit www.wago.com



Sensor terminal block paired with a 3-conductor sensor

Accessories; 280 Series
Appropriate marking system:
WMB

End and intermediate plate; 1 mm thick; for triple-deck terminal blocks

	orange	280-321	100 (25)
	gray	280-319	100 (25)

Insulation stop; 0.08 ... 0.2 mm² "s" (0.14 mm² "f-st"); 5 pcs/strip

	white	280-470	200 (25)
---	-------	---------	----------

Insulation stop; 0.25 ... 0.5 mm²; 5 pcs/strip

	light gray	280-471	200 (25)
---	------------	---------	----------

Insulation stop; 0.75 ... 1 mm²; 5 pcs/strip

	dark gray	280-472	200 (25)
---	-----------	---------	----------

Adjacent jumper; insulated; I_N = I_N terminal block

	gray	280-402	200 (25)
---	------	---------	----------

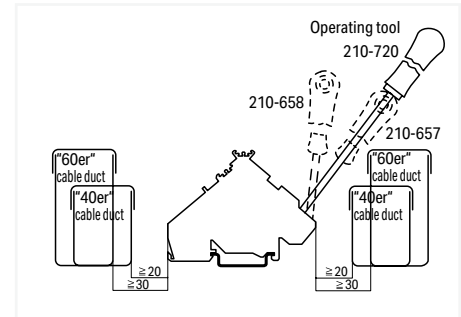

Min. mounting distance – terminal blocks to cable duct

6

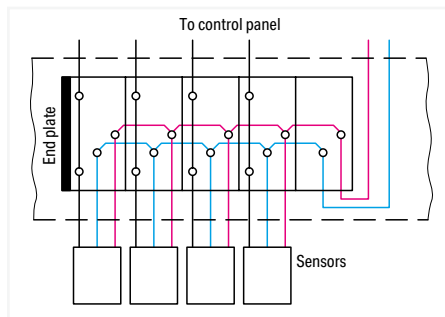

Power supply from sensor side

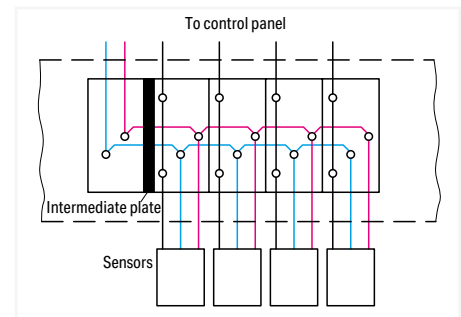

Power supply from control panel side

Sensor LED Terminal Block; for 3-Conductor Sensors

2.5 mm²; 280 Series

Technical Data	
0.08 ... 2.5 mm ²	28 ... 12 AWG*
24 VDC ⓘ	24 V, 15 A ⓘ
20 A	300 V, 15 A ⓘ
Terminal block width: 5 mm / 0.197 inch	
8 ... 9 mm / 0.31 ... 0.35 inch	

Technical Data	
0.08 ... 2.5 mm ²	28 ... 12 AWG*
24 VDC ⓘ	24 V, 15 A ⓘ
20 A	300 V, 15 A ⓘ
Terminal block width: 5 mm / 0.197 inch	
8 ... 9 mm / 0.31 ... 0.35 inch	

*12 AWG: THHN, THWN

ⓘ Other voltages are available upon request.

Please observe the application notes:
Insulation stop, page 425
Marking, from page 684

Approvals and corresponding ratings,
visit www.wago.com

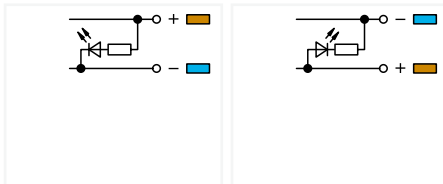
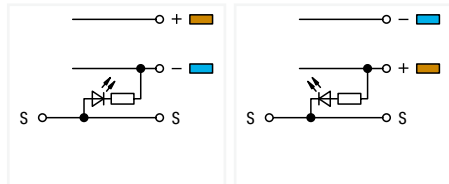
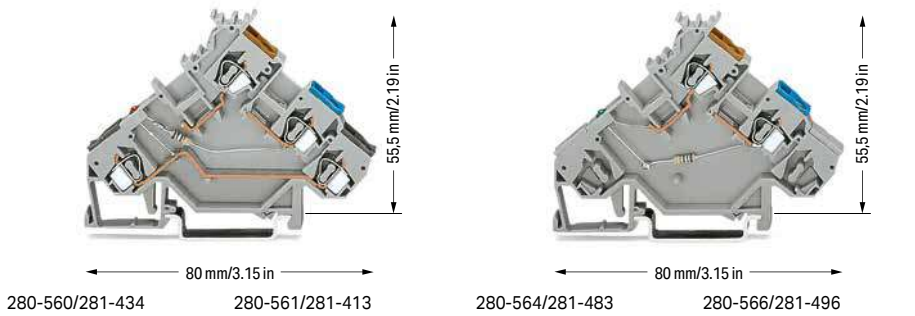

Sensor LED terminal block; for PNP (high-side) switching sensors; red LED; LED power consumption: 4.8 mA

Sensor LED supply terminal block; power supply from sensor side; for PNP (high-side) switching sensors; green LED; LED power consumption: 4.8 mA

Color	Item No.	Pack. Unit
○ gray	280-560/281-434	50

Color	Item No.	Pack. Unit
○ gray	280-564/281-483	10

Sensor LED terminal block; for NPN (low-side) switching sensors; red LED; LED power consumption: 4.8 mA

Sensor LED supply terminal block; power supply from sensor side; for NPN (low-side) switching sensors; green LED; LED power consumption: 4.8 mA

○ gray	280-561/281-413	50
--------	-----------------	----

○ gray	280-566/281-496	10
--------	-----------------	----

Accessories; 280 Series

Appropriate marking system: WMB

End and intermediate plate; 1 mm thick; for triple-deck terminal blocks

orange	280-321	100 (25)
gray	280-319	100 (25)

Insulation stop; 0.75 ... 1 mm²; 5 pcs/strip

dark gray	280-472	200 (25)
-----------	---------	----------

Insulation stop; 0.08 ... 0.2 mm² "s" (0.14 mm² "f-st"); 5 pcs/strip

white	280-470	200 (25)
-------	---------	----------

Adjacent jumper; insulated; I_N = I_N terminal block

gray	280-402	200 (25)
------	---------	----------

Insulation stop; 0.25 ... 0.5 mm²; 5 pcs/strip

light gray	280-471	200 (25)
------------	---------	----------

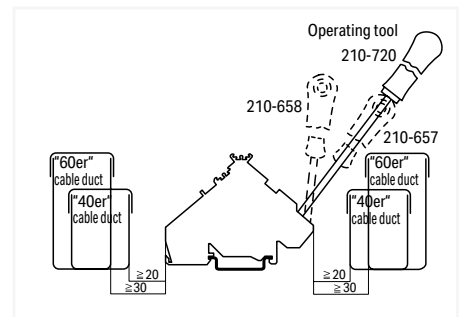
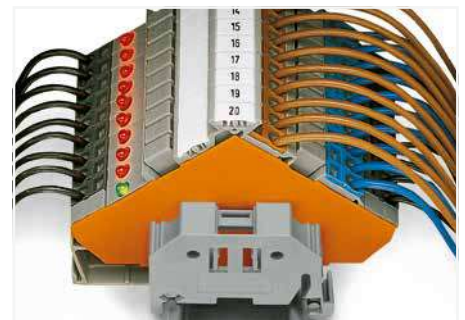

Min. mounting distance – terminal blocks to cable duct

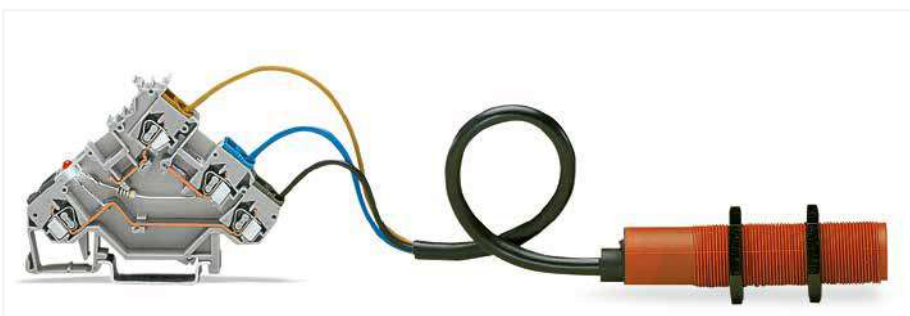

Sensor LED terminal block with a 3-conductor sensor

Sensor LED Terminal Block; for 4-Conductor Sensors 2.5 mm²; 280 Series

Technical Data	
0.08 ... 2.5 mm ²	28 ... 12 AWG*
24 VDC ⓘ	24 V, 15 A ⓘ
20 A	300 V, 15 A ⓘ
Terminal block width: 5 mm / 0.197 inch	
8 ... 9 mm / 0.31 ... 0.35 inch	

Technical Data	
0.08 ... 2.5 mm ²	28 ... 12 AWG*
24 VDC ⓘ	24 V, 15 A ⓘ
20 A	300 V, 15 A ⓘ
Terminal block width: 5 mm / 0.197 inch	
8 ... 9 mm / 0.31 ... 0.35 inch	

*12 AWG: THHN, THWN

ⓘ Other voltages are available upon request.

Please observe the application notes:
Insulation stop, page 425
Marking, from page 684

Approvals and corresponding ratings,
visit www.wago.com

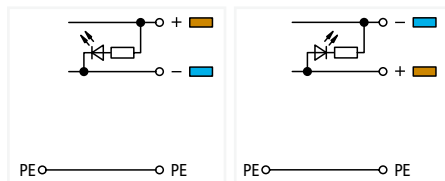
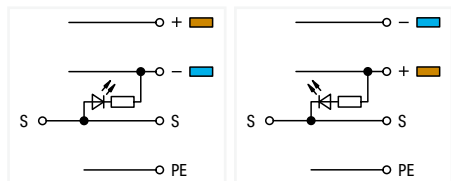
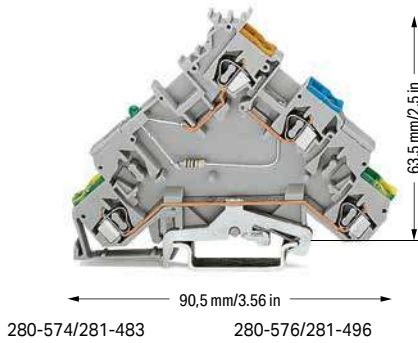

Sensor LED terminal block; for PNP (high-side) switching sensors; red LED; LED power consumption: 4.8 mA

Sensor LED supply terminal block; power supply from sensor side; for PNP (high-side) switching sensors; green LED; LED power consumption: 4.8 mA

Color	Item No.	Pack. Unit
gray	280-570/281-434	50

Color	Item No.	Pack. Unit
gray	280-574/281-483	10

Sensor LED terminal block; for NPN (low-side) switching sensors; red LED; LED power consumption: 4.8 mA

Sensor LED supply terminal block; power supply from control panel side; for PNP (high-side) switching sensors; green LED; LED power consumption: 4.8 mA

gray	280-571/281-413	50
------	-----------------	----

gray	280-576/281-496	10
------	-----------------	----

Sensor LED supply terminal block; power supply from control panel side; for NPN (low-side) switching sensors; green LED; LED power consumption: 4.8 mA
Terminal block width: 6 mm / 0.236 inch

gray	280-577/281-496	20
------	-----------------	----

Accessories; 280 Series

Appropriate marking system: WMB

End and intermediate plate; 1 mm thick; for quadruple-deck terminal blocks

orange	280-323	100 (25)
gray	280-320	100 (25)

Insulation stop; 0.08 ... 0.2 mm² "s" (0.14 mm² "f-st"); 5 pcs/strip

white	280-470	200 (25)
-------	---------	----------

Insulation stop; 0.25 ... 0.5 mm²; 5 pcs/strip

light gray	280-471	200 (25)
------------	---------	----------

Insulation stop; 0.75 ... 1 mm²; 5 pcs/strip

dark gray	280-472	200 (25)
-----------	---------	----------

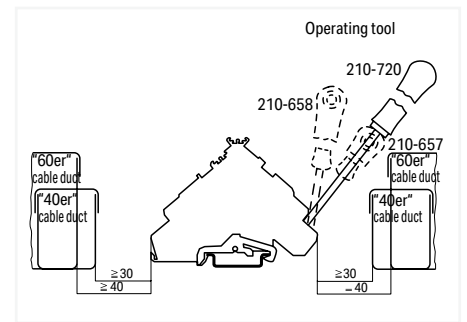

Min. mounting distance – terminal blocks to cable duct

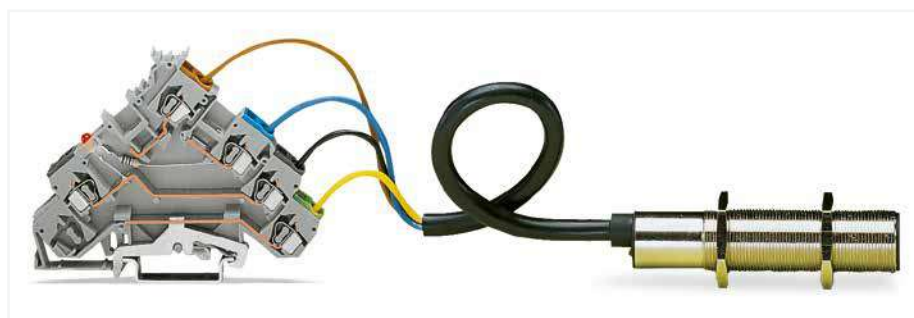

Sensor LED terminal block paired with a 3-conductor sensor (ground connection)

Sensor terminal block; with ground connection; for 3-conductor sensors 2.5 mm²; 280 Series

Technical Data	
0.08 ... 2.5 mm ²	28 ... 12 AWG*
400 V / 6 kV / 3 ⚡	300 V, 15 A ⚡
I _N 20 A	300 V, 15 A Ⓢ
Terminal block width: 5 mm / 0.197 inch	
8 ... 9 mm / 0.31 ... 0.35 inch	

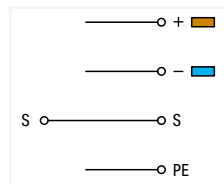
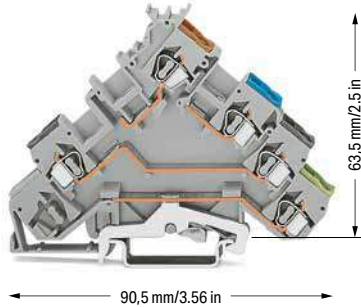

Sensor terminal block; with ground connection		
Color	Item No.	Pack. Unit
○ gray	280-570	50

Technical Data	
0.08 ... 2.5 mm ²	28 ... 12 AWG*
250 V / 4 kV / 3 ⚡	300 V, 6 A ⚡
I _N 6 A	300 V, 15 A Ⓢ
Terminal block width: 5 mm / 0.197 inch	
8 ... 9 mm / 0.31 ... 0.35 inch	

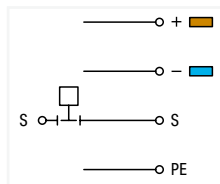
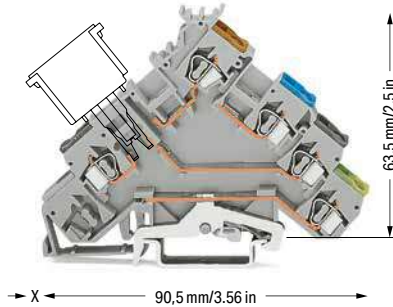

Sensor terminal block; with ground connection; for component plugs		
Color	Item No.	Pack. Unit
○ gray	280-571 Ⓢ	50

Technical Data	
0.08 ... 2.5 mm ²	28 ... 12 AWG*
400 V / 6 kV / 3 ⚡	300 V, 10 A ⚡
I _N 10 A	300 V, 15 A Ⓢ
Terminal block width: 5 mm / 0.197 inch	
8 ... 9 mm / 0.31 ... 0.35 inch	

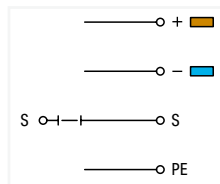
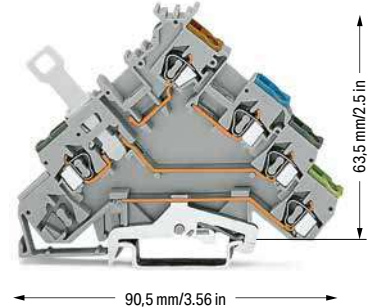

Sensor disconnect terminal block; with ground connection; for signal interruption		
Color	Item No.	Pack. Unit
○ gray	280-573	50

6

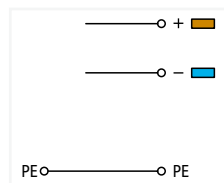
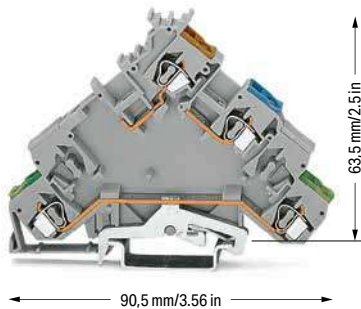

Sensor supply terminal block; with ground connection; power supply from sensor side		
Color	Item No.	Pack. Unit
○ gray	280-574	10

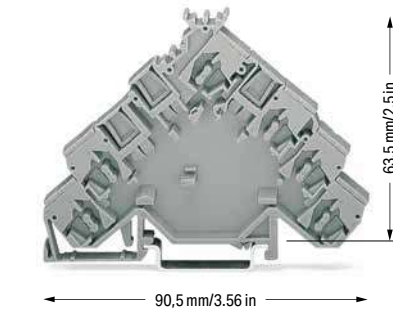

Spacer; same profile as 4-conductor sensor terminal blocks; 3-conductor sensor terminal blocks with ground connection or corresponding actuator terminal blocks Spacers with the same profile clearly differentiate between sensor or actuator terminal groups, e.g., of different power supply.		
Color	Item No.	Pack. Unit
○ gray	280-582	50

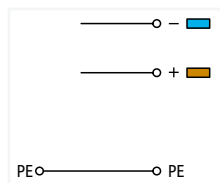
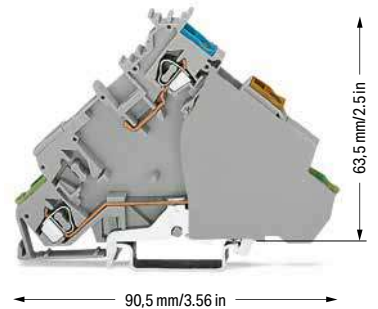

Sensor supply terminal block; with ground connection; power supply from control panel side; with end plate Terminal block width: 6 mm / 0.236 inch		
Color	Item No.	Pack. Unit
○ gray	280-577	20

Technical Data	
400 V / 6 kV / 3	I _N 20 A

- *12 AWG: THHN, THWN
 - ❶ 400 V / 250 V = rated voltage
6 kV / 4 kV = rated impulse voltage
3 = pollution degree
(see Section 15)
 - ❷ Electrical ratings are given by the fuse plug or empty component plug housing.
 - ❸ Empty component plug housings, see Full Line Catalog, Interface Modules, Volume 4
x = 12 mm/0.472 inch
Fuse plug (280-850), see page 380
x = 20 mm/0.787 inch
- Please observe the application notes:
Insulation stop, page 425
Marking, from page 684
- Approvals and corresponding ratings,
visit www.wago.com

Accessories; 280 Series
Appropriate marking system:
WMB

End and intermediate plate; 1 mm thick; for quadruple-deck terminal blocks

	orange	280-323	100 (25)
	gray	280-320	100 (25)

Insulation stop; 0.08 ... 0.2 mm² "s" (0.14 mm² "f-st"); 5 pcs/strip

	white	280-470	200 (25)
---	-------	---------	----------

Insulation stop; 0.25 ... 0.5 mm²; 5 pcs/strip

	light gray	280-471	200 (25)
---	------------	---------	----------

Insulation stop; 0.75 ... 1 mm²; 5 pcs/strip

	dark gray	280-472	200 (25)
---	-----------	---------	----------

Adjacent jumper; insulated; I_N = I_N terminal block

	gray	280-402	200 (25)
---	------	---------	----------

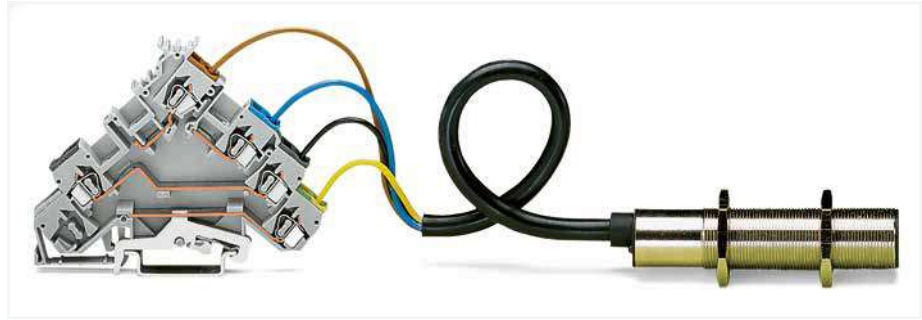

Sensor terminal block paired with a 3-conductor sensor

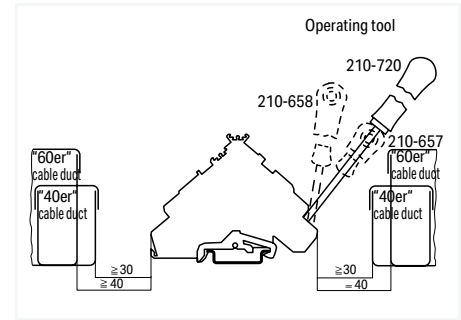

Min. mounting distance – terminal blocks to cable duct

6

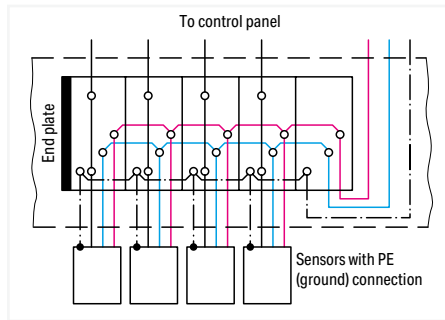

Power supply from sensor side

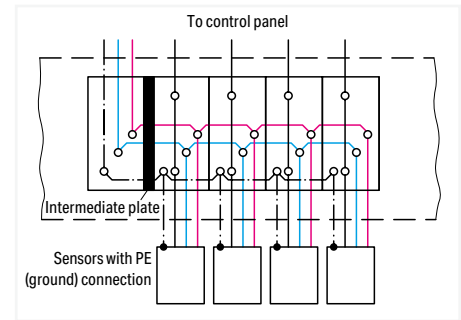

Power supply from control panel side

Sensor terminal block; for 4-conductor sensors 2.5 mm²; 280 Series

Technical Data

0.08 ... 2.5 mm ²	28 ... 12 AWG*
400 V / 6 kV / 3 ①	300 V, 15 A ②
I _N 20 A	300 V, 15 A ③
Terminal block width: 5 mm / 0.197 inch	
8 ... 9 mm / 0.31 ... 0.35 inch	

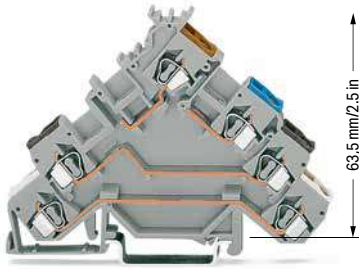

90,5 mm/3.56 in

63,5 mm/2.5 in

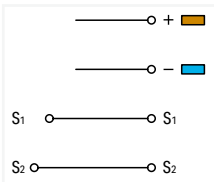

Sensor terminal block

Color	Item No.	Pack. Unit
○ gray	280-580	50

Technical Data

0.08 ... 2.5 mm ²	28 ... 12 AWG*
125 V / 5 A ②	300 V, 6 A ③
250 V / 6.3 A ②	300 V, 15 A ③
Terminal block width: 5 mm / 0.197 inch	
8 ... 9 mm / 0.31 ... 0.35 inch	

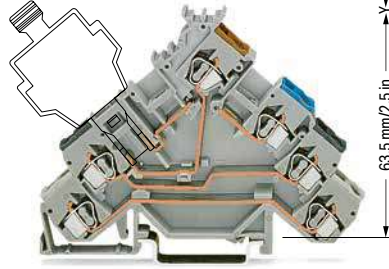

90,5 mm/3.56 in

63,5 mm/2.5 in

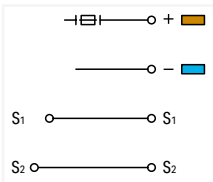

Sensor LED terminal block; for fuse plugs; for PNP (high-side) switching sensors; without end plate

Color	Item No.	Pack. Unit
○ gray	280-588 ④	50

Technical Data

0.08 ... 2.5 mm ²	28 ... 12 AWG*
400 V / 6 kV / 3 ①	24 V, 15 A ②
I _N 10 A	300 V, 15 A ③
Terminal block width: 6 mm / 0.236 inch	
8 ... 9 mm / 0.31 ... 0.35 inch	

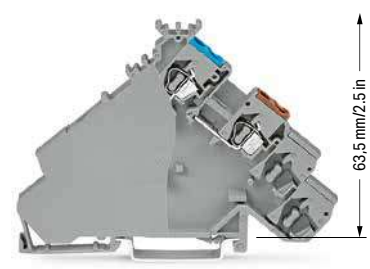

90,5 mm/3.56 in

63,5 mm/2.5 in



Sensor supply terminal block; power supply from control panel side; with end plate

Color	Item No.	Pack. Unit
○ gray	280-587	50

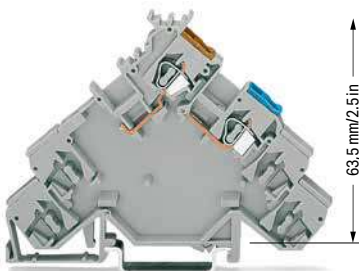

90,5 mm/3.56 in

63,5 mm/2.5 in



Sensor supply terminal block; power supply from sensor side; without end plate

Color	Item No.	Pack. Unit
○ gray	280-584	10

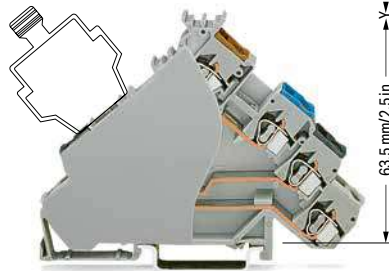

90,5 mm/3.56 in

63,5 mm/2.5 in



Sensor LED terminal block; for fuse plugs; for PNP (high-side) switching sensors; with gray end plate

Color	Item No.	Pack. Unit
○ gray	280-588/280-320	50

Sensor LED terminal block; for fuse plugs; for PNP (high-side) switching sensors; with orange end plate

Color	Item No.	Pack. Unit
○ gray	280-588/280-323	50

*12 AWG: THHN, THWN

- ❶ 400 V = rated voltage
6 kV = rated impulse voltage
3 = pollution degree
(see Section 15)
- ❷ Electrical ratings are given by the fuse plug or empty component plug housing.
- ❸ Empty component plug housings, see Full Line Catalog, Interface Modules, Volume 4
x = 12 mm/0.472 inch
Fuse plug (281-511), see page 378
y = 15.5 mm/0.61 inch
x = 10 mm/0.394 inch



Please observe the application notes:
Insulation stop, page 425
Marking, from page 684

Approvals and corresponding ratings,
visit www.wago.com

Accessories; 280 Series

Appropriate marking system:
WMB

End and intermediate plate; 1 mm thick; for quadruple-deck terminal blocks

	orange	280-323	100 (25)
	gray	280-320	100 (25)

Insulation stop; 0.08 ... 0.2 mm² "s" (0.14 mm² "f-st"); 5 pcs/strip

	white	280-470	200 (25)
---	-------	---------	----------

Insulation stop; 0.25 ... 0.5 mm²; 5 pcs/strip

	light gray	280-471	200 (25)
---	------------	---------	----------

Insulation stop; 0.75 ... 1 mm²; 5 pcs/strip

	dark gray	280-472	200 (25)
---	-----------	---------	----------

Adjacent jumper; insulated; I_N = I_N terminal block

	gray	280-402	200 (25)
---	------	---------	----------



Sensor terminal block paired with a 4-conductor sensor

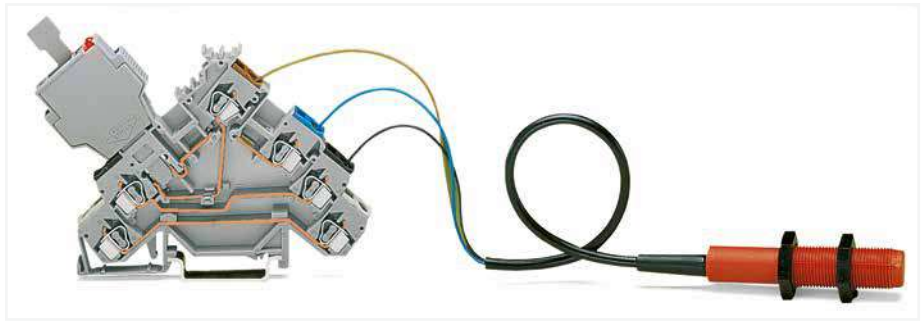

Sensor terminal block (with a fuse plug) paired with a 3-conductor sensor

6



The fuse plug is 1 mm wider than the terminal block, so an intermediate plate must be installed.

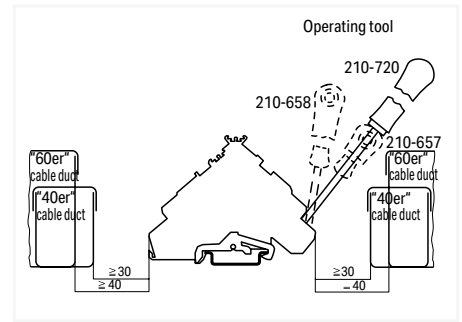

Min. mounting distance – terminal blocks to cable duct

Sensor LED Terminal Block; for 4-Conductor Sensors 2.5 mm²; 280 Series

Technical Data	
0.08 ... 2.5 mm ²	28 ... 12 AWG*
24 VDC Ⓢ	24 V, 15 A
20 A	
Terminal block width: 5 mm / 0.197 inch	
8 ... 9 mm / 0.31 ... 0.35 inch	

Technical Data	
0.08 ... 2.5 mm ²	28 ... 12 AWG*
24 VDC Ⓢ	24 V, 15 A
20 A	300 V, 15 A Ⓢ
Terminal block width: 5 mm / 0.197 inch	
8 ... 9 mm / 0.31 ... 0.35 inch	

*12 AWG: THHN, THWN

Ⓢ Other voltages are available upon request.

Please observe the application notes:
Insulation stop, page 425
Marking, from page 684

Approvals and corresponding ratings,
visit www.wago.com

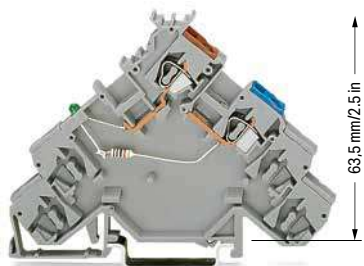
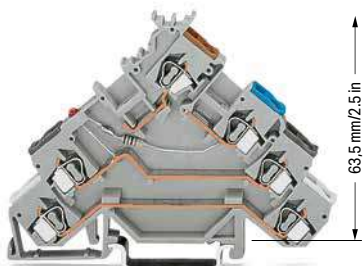

280-580/281-434 280-581/281-413

280-584/281-483 280-586/281-496

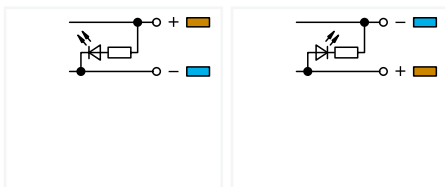
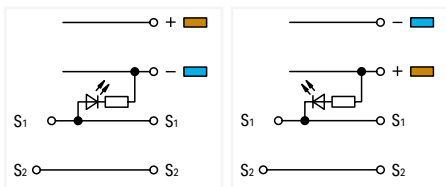

Sensor LED terminal block; for PNP (high-side) switching sensors; red LED; LED power consumption: 4.8 mA

Sensor LED supply terminal block; power supply from sensor side; for PNP (high-side) switching sensors; green LED; LED power consumption: 4.8 mA

Color	Item No.	Pack. Unit
○ gray	280-580/281-434	50

Color	Item No.	Pack. Unit
○ gray	280-584/281-483	10

Sensor LED terminal block; for NPN (low-side) switching sensors; red LED; LED power consumption: 4.8 mA

Sensor LED supply terminal block; power supply from sensor side; for NPN (low-side) switching sensors; green LED; LED power consumption: 4.8 mA

○ gray	280-581/281-413	50
--------	-----------------	----

○ gray	280-586/281-496	10
--------	-----------------	----

Accessories; 280 Series

Appropriate marking system: WMB

End and intermediate plate; 1 mm thick; for quadruple-deck terminal blocks

orange	280-323	100 (25)
gray	280-320	100 (25)

Insulation stop; 0.75 ... 1 mm²; 5 pcs/strip

dark gray	280-472	200 (25)
-----------	---------	----------

Insulation stop; 0.08 ... 0.2 mm² "s" (0.14 mm² "f-st"); 5 pcs/strip

white	280-470	200 (25)
-------	---------	----------

Adjacent jumper; insulated; I_N = I_N terminal block

gray	280-402	200 (25)
------	---------	----------

Insulation stop; 0.25 ... 0.5 mm²; 5 pcs/strip

light gray	280-471	200 (25)
------------	---------	----------

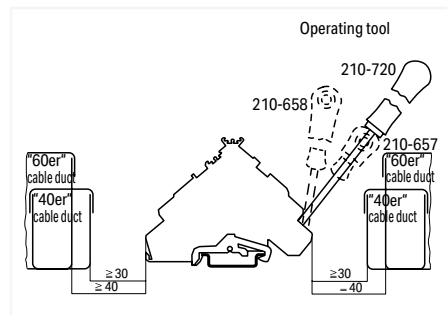

Min. mounting distance – terminal blocks to cable duct

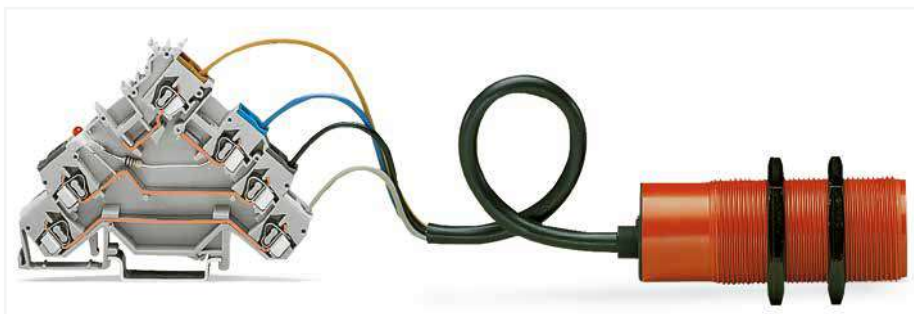

Sensor LED terminal block paired with a 4-conductor sensor

6

Actuator terminal block; for pressure and thermo switches

2.5 mm²; 280 Series

Technical Data	
0.08 ... 2.5 mm ²	28 ... 12 AWG*
400 V / 6 kV / 3 ①	300 V, 15 A ②
I _N 20 A	300 V, 15 A ③
Terminal block width: 5 mm / 0.197 inch	
8 ... 9 mm / 0.31 ... 0.35 inch	

Technical Data	
0.08 ... 2.5 mm ²	28 ... 12 AWG*
400 V / 6 kV / 3 ①	300 V, 15 A ②
I _N 20 A	300 V, 15 A ③
Terminal block width: 6 mm / 0.236 inch	
8 ... 9 mm / 0.31 ... 0.35 inch	

*12 AWG: THHN, THWN

① 400 V = rated voltage
6 kV = rated impulse voltage
3 = pollution degree
(see Section 15)

Please observe the application notes:
Insulation stop, page 425
Marking, from page 684

Approvals and corresponding ratings,
visit www.wago.com

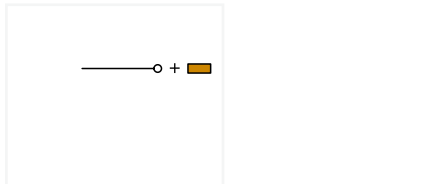
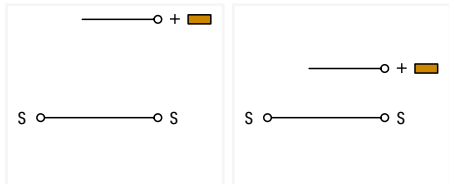
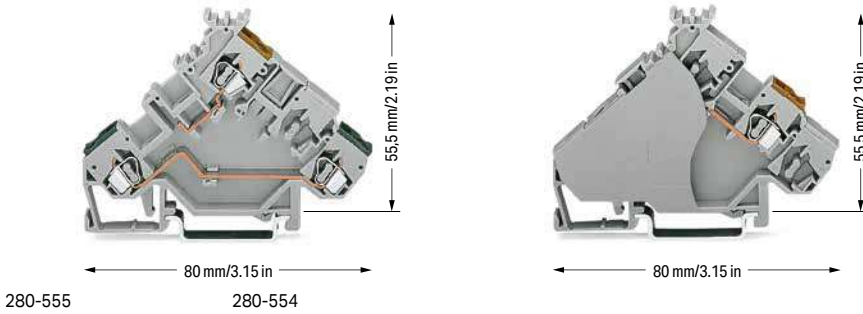

Actuator terminal block		
Color	Item No.	Pack. Unit
○ gray	280-555	50

Actuator supply terminal block; in connection with 280-555: power supply from control panel side; in connection with 280-554: power supply from actuator side; with end plate		
Color	Item No.	Pack. Unit
○ gray	280-556	20

Actuator terminal block		
Color	Item No.	Pack. Unit
○ gray	280-554	50

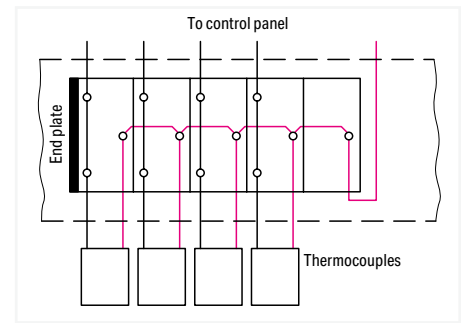

Power supply from actuator side

Accessories; 280 Series

Appropriate marking system: WMB

End and intermediate plate; 1 mm thick; for triple-deck terminal blocks		
orange	280-321	100 (25)
gray	280-319	100 (25)

Insulation stop; 0.75 ... 1 mm ² ; 5 pcs/strip		
dark gray	280-472	200 (25)

Insulation stop; 0.08 ... 0.2 mm ² "s" (0.14 mm ² "f-st"); 5 pcs/strip		
white	280-470	200 (25)

Adjacent jumper; insulated; I _N = I _N terminal block		
gray	280-402	200 (25)

Insulation stop; 0.25 ... 0.5 mm ² ; 5 pcs/strip		
light gray	280-471	200 (25)

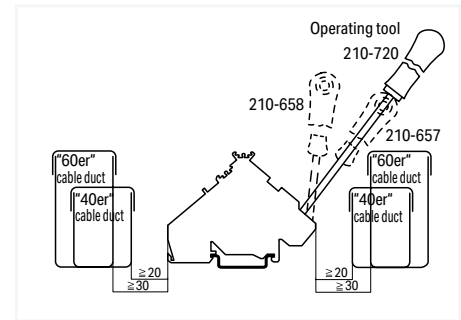

Min. mounting distance – terminal blocks to cable duct



Actuator terminal block with thermocouple

Actuator terminal block; for Magnetic Valves and Servo Motors 2.5 mm²; 280 Series

Technical Data	
0.08 ... 2.5 mm ²	28 ... 12 AWG*
400 V / 6 kV / 3; 20 A ① ②	300 V, 15 A ④
250 V / 4 kV / 3; 20 A ① ②	300 V, 15 A ⑥
Terminal block width: 5 mm / 0.197 inch	
8 ... 9 mm / 0.31 ... 0.35 inch	

Technical Data	
0.08 ... 2.5 mm ²	28 ... 12 AWG*
125 V / 5 A ②	300 V, 6 A ④
250 V / 6.3 A ②	300 V, 15 A ⑥
Terminal block width: 5 mm / 0.197 inch	
8 ... 9 mm / 0.31 ... 0.35 inch	

Technical Data	
0.08 ... 2.5 mm ²	28 ... 12 AWG*
400 V / 6 kV / 3 ①	300 V, 10 A ④
I _N 10 A	300 V, 15 A ⑥
Terminal block width: 5 mm / 0.197 inch	
8 ... 9 mm / 0.31 ... 0.35 inch	

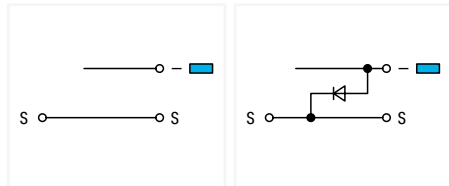
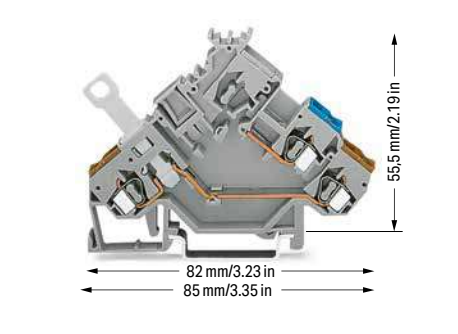
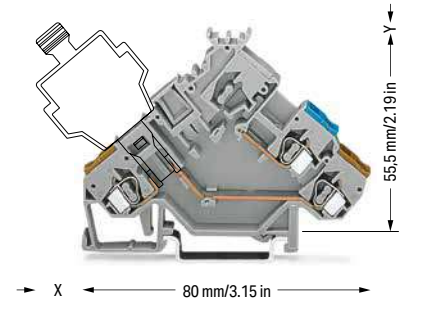
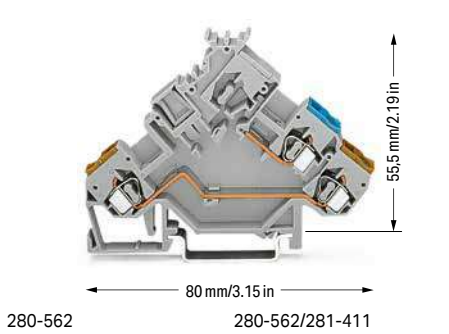

Actuator terminal block		
Color	Item No.	Pack. Unit
○ gray	280-562	50

Actuator terminal block; for fuse plugs; for phase protection; without end plate		
Color	Item No.	Pack. Unit
○ gray	280-565 ③	50

Actuator disconnect terminal block; for phase interruption		
Color	Item No.	Pack. Unit
○ gray	280-566	50

Actuator terminal block; with 1N4007 recovery diode		
Color	Item No.	Pack. Unit
○ gray	280-562/281-411	50

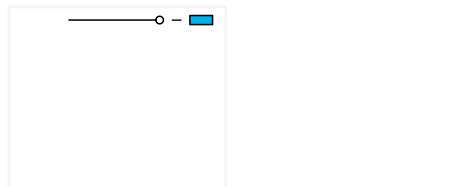
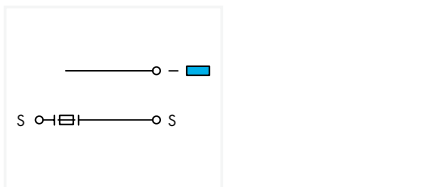
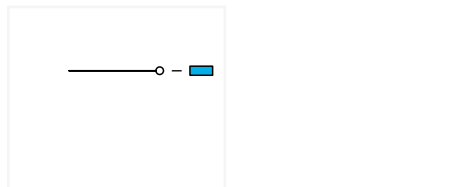
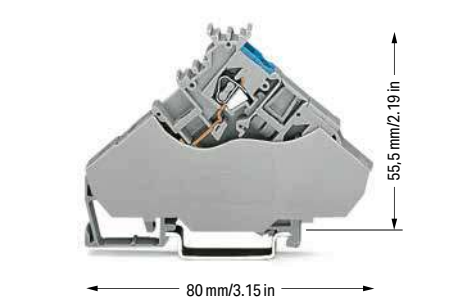
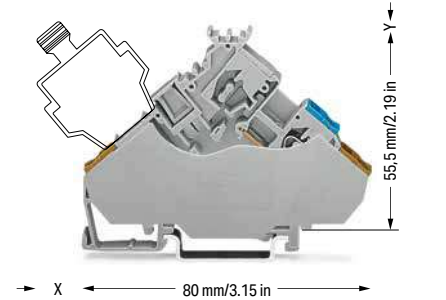
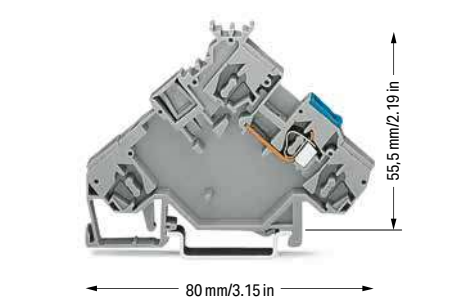

Actuator supply terminal block; power supply from actuator side		
Color	Item No.	Pack. Unit
○ gray	280-592	10

Actuator terminal block; for fuse plugs; for phase protection; with gray end plate		
Color	Item No.	Pack. Unit
○ gray	280-565/281-319	50
Terminal block width: 6 mm / 0.236 inch		

Actuator supply terminal block; power supply from control panel side; with end plate		
Color	Item No.	Pack. Unit
○ gray	280-568	20
Terminal block width: 6 mm / 0.236 inch		

Actuator terminal block; for fuse plugs; for phase protection; with orange end plate		
Color	Item No.	Pack. Unit
○ gray	280-565/281-321	50
Terminal block width: 6 mm / 0.236 inch		

Technical Data		
400 V / 6 kV / 3	I _N 20 A	

6

*12 AWG: THHN, THWN

1 400 V / 250 V = rated voltage
6 kV / 4 kV = rated impulse voltage
3 = pollution degree
(see Section 15)

2 Electrical ratings are given by the fuse plug or empty component plug housing.

3 Empty component plug housings, see Full Line Catalog, Interface Modules, Volume 4
x = 12 mm/0.472 inch
Fuse plug (281-511), see page 378
y = 15.5 mm/0.61 inch
x = 10 mm/0.394 inch

Please observe the application notes:
Insulation stop, page 425
Marking, from page 684

Approvals and corresponding ratings, visit www.wago.com



Sensor terminal block paired with a 3-conductor sensor

Accessories; 280 Series

Appropriate marking system:
WMB

End and intermediate plate; 1 mm thick; for triple-deck terminal blocks

	orange	280-321	100 (25)
	gray	280-319	100 (25)

Insulation stop; 0.08 ... 0.2 mm² "s" (0.14 mm² "f-st"); 5 pcs/strip

	white	280-470	200 (25)
---	-------	---------	----------

Insulation stop; 0.25 ... 0.5 mm²; 5 pcs/strip

	light gray	280-471	200 (25)
---	------------	---------	----------

Insulation stop; 0.75 ... 1 mm²; 5 pcs/strip

	dark gray	280-472	200 (25)
---	-----------	---------	----------

Adjacent jumper; insulated; I_N = I_N terminal block

	gray	280-402	200 (25)
---	------	---------	----------

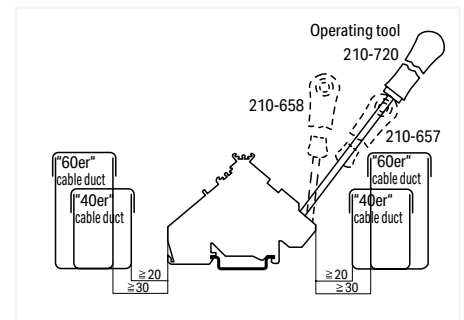

Min. mounting distance – terminal blocks to cable duct

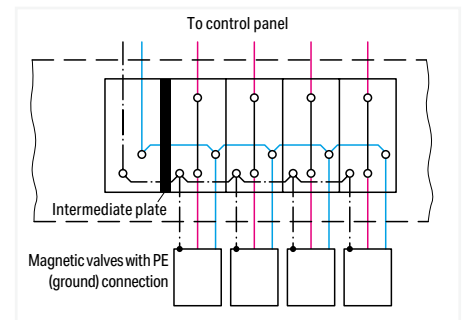
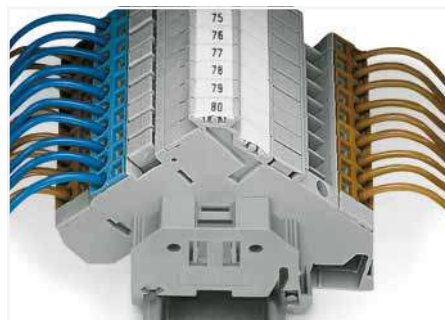

Power supply from control panel side

Actuator terminal block; with ground connection; for magnetic valves and servo motors

2.5 mm²; 280 Series

Technical Data	
0.08 ... 2.5 mm ²	28 ... 12 AWG*
400 V / 6 kV / 3; 20 A ① ②	300 V, 15 A ④
250 V / 4 kV / 3; 20 A ① ②	300 V, 15 A ⑥
Terminal block width: 5 mm / 0.197 inch	
8 ... 9 mm / 0.31 ... 0.35 inch	

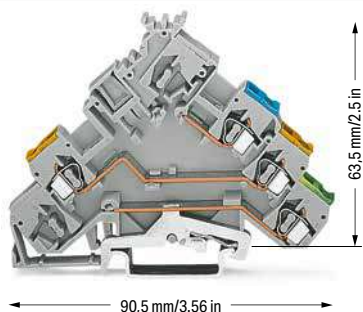

280-572 280-572/281-411

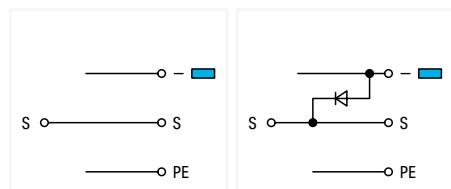

Actuator terminal block; with ground connection		
Color	Item No.	Pack. Unit
○ gray	280-572	50

Technical Data	
0.08 ... 2.5 mm ²	28 ... 12 AWG*
125 V / 5 A ②	300 V, 6 A ④
250 V / 6.3 A ②	300 V, 15 A ⑥
Terminal block width: 5 mm / 0.197 inch	
8 ... 9 mm / 0.31 ... 0.35 inch	

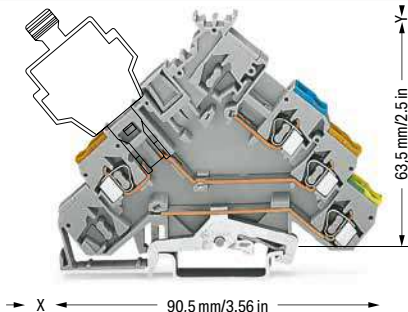

X 90,5 mm/3.56 in

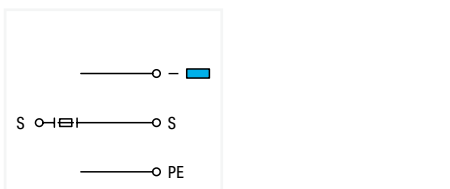

Actuator terminal block; with ground connection; for fuse plugs; for phase protection; without end plate		
Color	Item No.	Pack. Unit
○ gray	280-575 ③	50

Technical Data	
0.08 ... 2.5 mm ²	28 ... 12 AWG*
400 V / 6 kV / 3 ①	300 V, 10 A ④
I _N 10 A	300 V, 15 A ⑥
Terminal block width: 5 mm / 0.197 inch	
8 ... 9 mm / 0.31 ... 0.35 inch	



90,5 mm/3.56 in



Actuator disconnect terminal block; with ground connection; for phase interruption		
Color	Item No.	Pack. Unit
○ gray	280-576	50

6

Actuator terminal block; with ground connection; with 1N4007 recovery diode		
Color	Item No.	Pack. Unit
○ gray	280-572/281-411	50

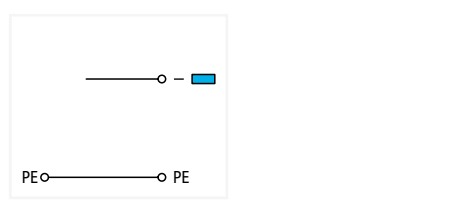

Actuator supply terminal block; with ground connection; power supply from actuator side		
Color	Item No.	Pack. Unit
○ gray	280-593	10

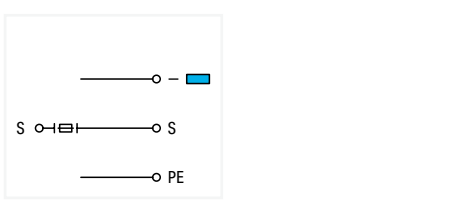
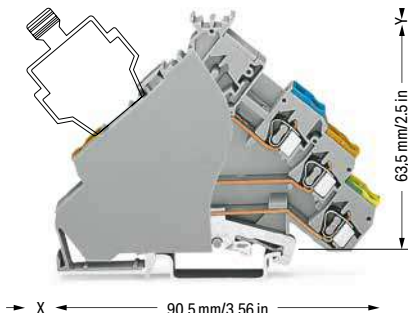

Actuator terminal block; with ground connection; for fuse plugs; for phase protection; with end plate		
Color	Item No.	Pack. Unit
○ gray	280-575/281-320	50

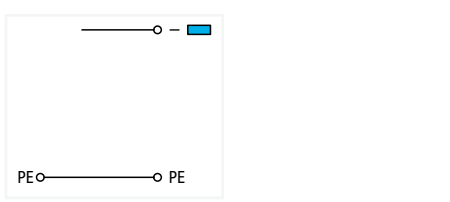
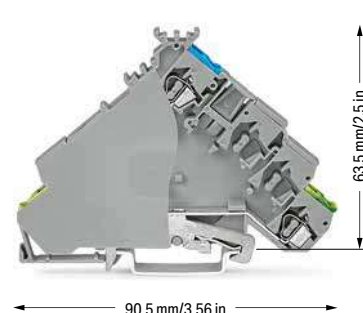

Actuator supply terminal block; with ground connection; power supply from control panel side; with end plate		
Color	Item No.	Pack. Unit
○ gray	280-578	20

Actuator terminal block; with ground connection; for fuse plugs; for phase protection; with orange end plate		
Color	Item No.	Pack. Unit
○ gray	280-575/281-323	50

Technical Data	
400 V / 6 kV / 3	I _N 20 A

*12 AWG: THHN, THWN

1 400 V / 250 V = rated voltage
6 kV / 4 kV = rated impulse voltage
3 = pollution degree
(see Section 15)

2 Electrical ratings are given by the fuse plug or empty component plug housing.

3 Empty component plug housings, see Full Line Catalog, Interface Modules, Volume 4
x = 12 mm/0.472 inch
Fuse plug (281-511), see page 378
x = 15.5 mm/0.61 inch
y = 10 mm/0.394 inch

Please observe the application notes:
Insulation stop, page 425
Marking, from page 684

Approvals and corresponding ratings, visit www.wago.com

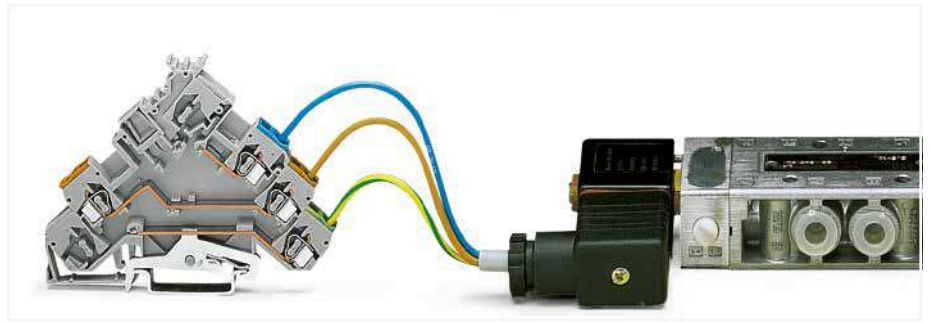

Actuator terminal block (ground connection) paired with a magnetic valve

Accessories; 280 Series

Appropriate marking system:
WMB

End and intermediate plate; 1 mm thick; for quadruple-deck terminal blocks

	orange	280-323	100 (25)
	gray	280-320	100 (25)

Insulation stop; 0.08 ... 0.2 mm² "s" (0.14 mm² "f-st"); 5 pcs/strip

	white	280-470	200 (25)
--	-------	---------	----------

Insulation stop; 0.25 ... 0.5 mm²; 5 pcs/strip

	light gray	280-471	200 (25)
--	------------	---------	----------

Insulation stop; 0.75 ... 1 mm²; 5 pcs/strip

	dark gray	280-472	200 (25)
--	-----------	---------	----------

Adjacent jumper; insulated; I_N = I_N terminal block

	gray	280-402	200 (25)
--	------	---------	----------

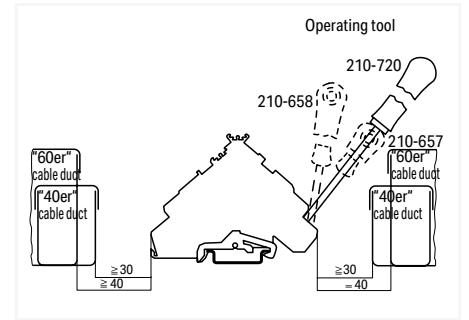

Min. mounting distance – terminal blocks to cable duct

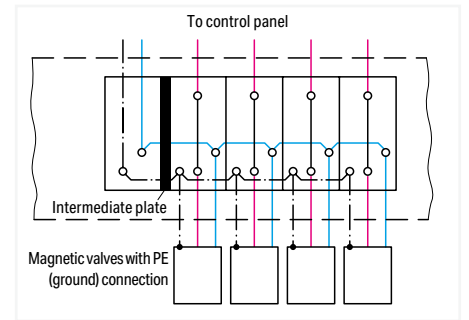
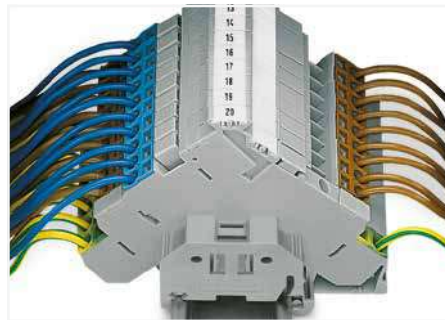

Power supply from control panel side

Actuator LED Terminal Block; with Ground Connection

2.5 mm²; 280 Series

Technical Data	
0.08 ... 2.5 mm ²	28 ... 12 AWG*
24 VDC ①	24 V, 15 A ②
20 A	300 V, 15 A ③
Terminal block width: 5 mm / 0.197 inch	
8 ... 9 mm / 0.31 ... 0.35 inch	

Technical Data	
0.08 ... 2.5 mm ²	28 ... 12 AWG*
24 VDC ①	24 V, 15 A ②
20 A	300 V, 15 A ③
Terminal block width: 5 mm / 0.197 inch	
8 ... 9 mm / 0.31 ... 0.35 inch	

*12 AWG: THHN, THWN

① Other voltages are available upon request.

Please observe the application notes: Insulation stop, page 425; Marking, from page 684

Approvals and corresponding ratings, visit www.wago.com

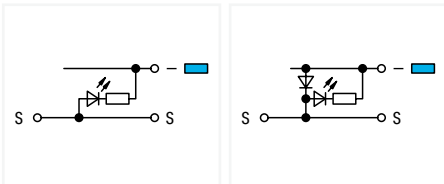
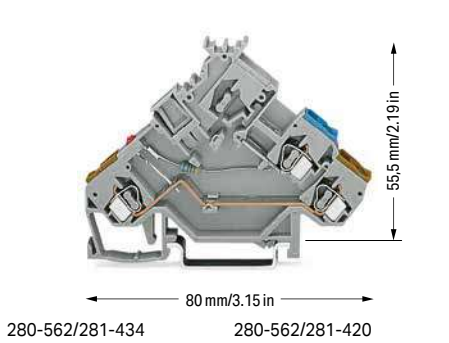

Actuator LED terminal block; red LED; LED power consumption: 4.8 mA

Color	Item No.	Pack. Unit
○ gray	280-562/281-434	50

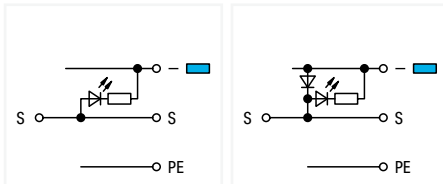

Actuator LED terminal block; with ground connection; red LED; LED power consumption: 4.8 mA

Color	Item No.	Pack. Unit
○ gray	280-572/281-434	50

Actuator LED terminal block; with 1N4007 recovery diode; red LED; LED power consumption: 4.8 mA

Color	Item No.	Pack. Unit
○ gray	280-562/281-420	50

Actuator LED terminal block; with ground connection; with 1N4007 recovery diode; red LED; LED power consumption: 4.8 mA

Color	Item No.	Pack. Unit
○ gray	280-572/281-420	50

Accessories; item-specific
End and intermediate plate; 1 mm thick; for triple-deck terminal blocks

	orange	280-321	100 (25)
	gray	280-319	100 (25)

Accessories; item-specific
End and intermediate plate; 1 mm thick; for quadruple-deck terminal blocks

	orange	280-323	100 (25)
	gray	280-320	100 (25)

Accessories; 280 Series

Appropriate marking system: WMB

Insulation stop; 0.08 ... 0.2 mm² "s" (0.14 mm² "f-st"); 5 pcs/strip

	white	280-470	200 (25)
--	-------	---------	----------

Insulation stop; 0.75 ... 1 mm²; 5 pcs/strip

	dark gray	280-472	200 (25)
--	-----------	---------	----------

Insulation stop; 0.25 ... 0.5 mm²; 5 pcs/strip

	light gray	280-471	200 (25)
--	------------	---------	----------

Adjacent jumper; insulated; I_N = I_N terminal block

	gray	280-402	200 (25)
--	------	---------	----------

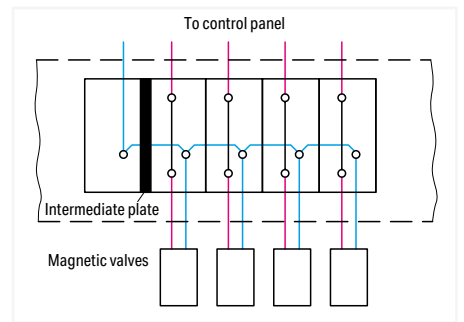
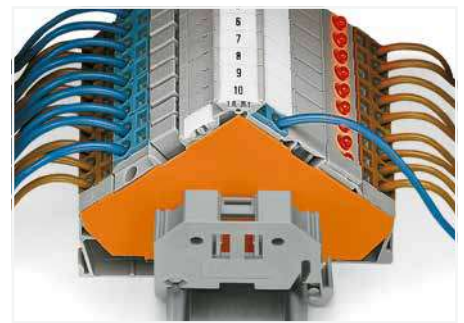

Power supply from control panel side

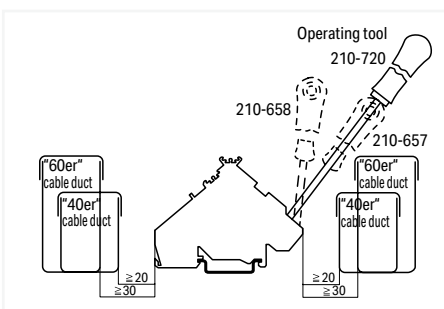

Min. mounting distance – terminal blocks to cable duct

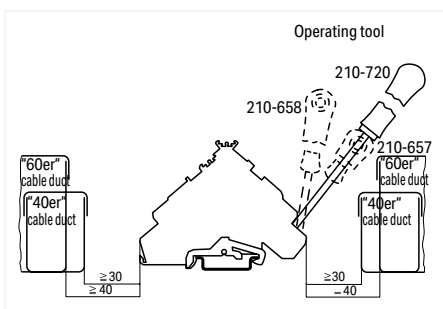

Min. mounting distance – terminal blocks to cable duct

Actuator Terminal Block for Actuators with Shield Connection and Actuators with Shield Conductor Through Contact (e.g., for Thermocouples)

2.5 mm²; 280 Series

Technical Data	
0.08 ... 2.5 mm ²	28 ... 12 AWG*
400 V / 6 kV / 3 ①	300 V, 15 A
I _N 20 A	300 V, 15 A @
Terminal block width: 5 mm / 0.197 inch	
8 ... 9 mm / 0.31 ... 0.35 inch	

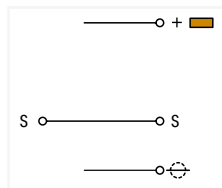
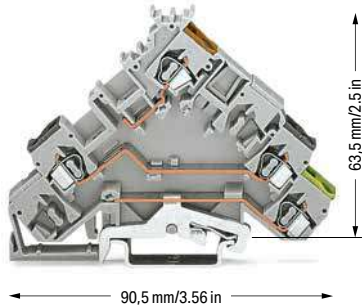

Actuator terminal block; with shield connection		
Color	Item No.	Pack. Unit
○ gray	280-585	50

Accessories; item-specific see page 361

Technical Data	
0.08 ... 2.5 mm ²	28 ... 12 AWG*
400 V / 6 kV / 3 ①	300 V, 15 A
I _N 20 A	
Terminal block width: 5 mm / 0.197 inch	
8 ... 9 mm / 0.31 ... 0.35 inch	

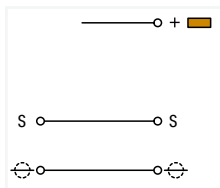
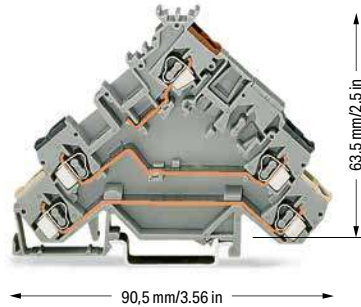

Actuator terminal block; with shield conductor through contact		
Color	Item No.	Pack. Unit
○ gray	280-583	50

Accessories; item-specific see page 361

*12 AWG: THHN, THWN

① 400 V = rated voltage
6 kV = rated impulse voltage
3 = pollution degree (see Section 15)

Please observe the application notes:
Insulation stop, see page 425
Marking, from page 684

Approvals and corresponding ratings, visit www.wago.com



Power supply from control panel side

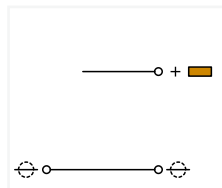
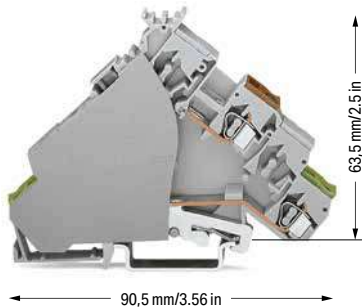

Actuator supply terminal block; with shield connection; power supply from control panel side; with end plate		
Color	Item No.	Pack. Unit
○ gray	280-586	10

Accessories; item-specific see page 361

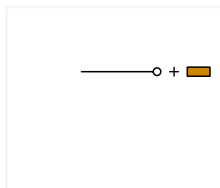
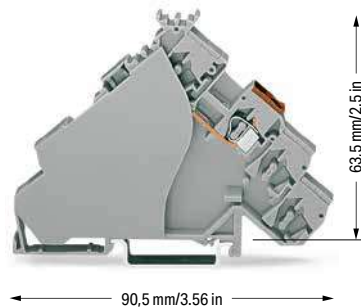

Actuator supply terminal block; power supply from control panel side; with end plate; for actuators with shield conductor through contact		
Color	Item No.	Pack. Unit
○ gray	280-515	50

Accessories; item-specific see page 361



Power supply from control panel side

Diode Terminal Block and LED Terminal Block

1.5 mm²; 279 Series

Technical Data	
0.08 ... 1.5 mm ²	28 ... 16 AWG
U _N 250 V; U _{RM} 1000 V	
1N4007 – 0.5 A continuous current	
Terminal block width: 4 mm / 0.157 inch	
8 ... 9 mm / 0.31 ... 0.35 inch	

Technical Data	
0.08 ... 1.5 mm ²	28 ... 16 AWG
U _N 250 V; U _{RM} 1000 V	
1N4007 – 0.5 A continuous current	
Terminal block width: 4 mm / 0.157 inch	
8 ... 9 mm / 0.31 ... 0.35 inch	

Technical Data	
0.08 ... 1.5 mm ²	28 ... 16 AWG
24 VDC	
I _F 0.025 A max.	
Terminal block width: 4 mm / 0.157 inch	
8 ... 9 mm / 0.31 ... 0.35 inch	

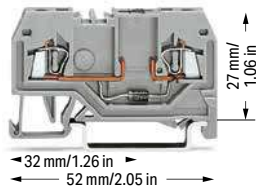

279-915/281-410

279-915/281-411

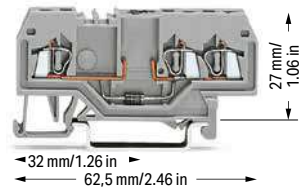

279-673/281-410

279-673/281-411

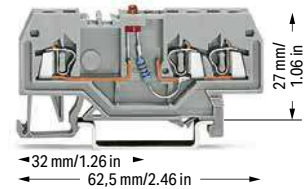

279-674/281-434

279-674/281-413

6

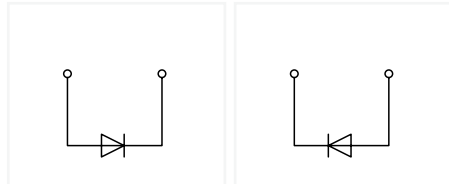

2-conductor diode terminal block; with 1N4007 diode; gray

	Item No.	Pack. Unit
○ anode left	279-915/281-410	100
○ anode right	279-915/281-411	100

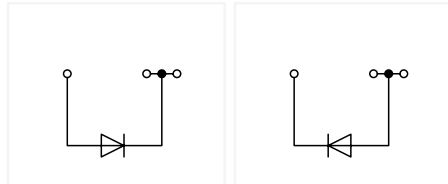

3-conductor diode terminal block; with 1N4007 diode; gray

	Item No.	Pack. Unit
○ anode left	279-673/281-410	100
○ anode right	279-673/281-411	100

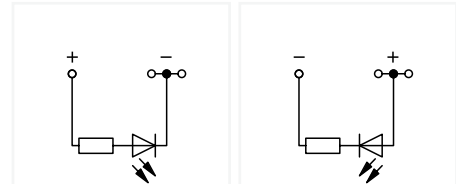

3-conductor LED terminal block; with red LED; gray

	Item No.	Pack. Unit
○ anode left	279-674/281-434	100
○ anode right	279-674/281-413	100

Other terminal blocks with the same profile:		
Through	279-901	Page 312

Other terminal blocks with the same profile:		
Through	279-681	Page 312

Other terminal blocks with the same profile:		
Through	279-681	Page 312

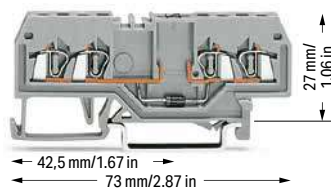

279-815/281-411

279-815/281-410

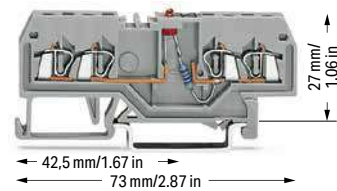

279-809/281-434

279-809/281-413

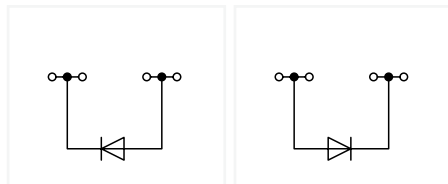

4-conductor diode terminal block; with 1N4007 diode; gray

	Item No.	Pack. Unit
○ anode right	279-815/281-411	100
○ anode left	279-815/281-410	100

Other terminal blocks with the same profile:		
Through	279-831	Page 312

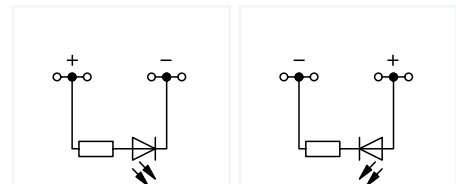

4-conductor LED terminal block; with red LED; gray

	Item No.	Pack. Unit
○ anode left	279-809/281-434	100
○ anode right	279-809/281-413	100

Other terminal blocks with the same profile:		
Through	279-831	Page 312

Diode Terminal Blocks and LED Terminal Blocks

Circuit Configuration Examples

Please observe the application notes:
 Insulation stop, page 425
 Comb-style jumper bar, page 426
 Marking, from page 684

Approvals and corresponding ratings,
 visit www.wago.com

Accessories; 279 Series

Appropriate marking system:
 WMB/WMB Inline

Insulation stop; 0.08 ... 0.2 mm² "s" (0.14 mm² "f-st"); 5 pcs/strip

	white	279-470	200 (25)
---	-------	---------	----------

Insulation stop; 0.25 mm²; 5 pcs/strip

	dark gray	279-471	200 (25)
---	-----------	---------	----------

Comb-style jumper bar; insulated; I_N = I_N of terminal block

	2-way	279-482	200 (25)
	3-way	279-483	200 (25)

Comb-style jumper bar; insulated; I_N = I_N of terminal block

	10-way	279-490	50 (25)
---	--------	---------	---------

Alternate comb-style jumper bar; insulated; I_N = I_N of terminal block

	2-way	279-492	200 (25)
---	-------	---------	----------

Operating tool; insulated

	2-way	279-432	1
	3-way	279-433	1

Operating tool; insulated

	10-way	279-440	1
---	--------	---------	---

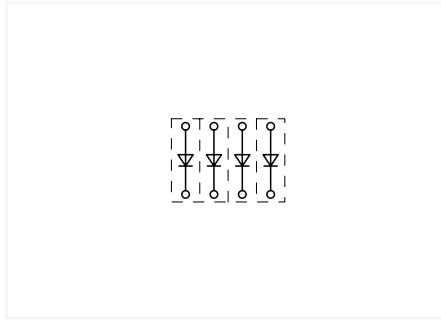

Open diode gates can be created using the following terminal blocks:
 279-915/281-410 or 279-915/281-411

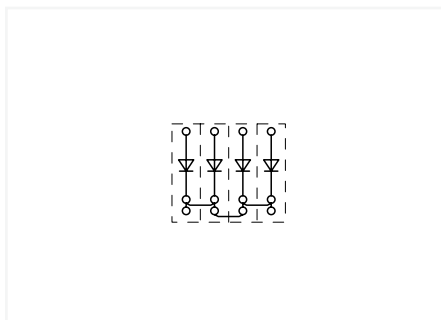

Polarized diode gates with a common cathode can be created using the following terminal blocks:
 279-673/281-410 or 279-673/281-411

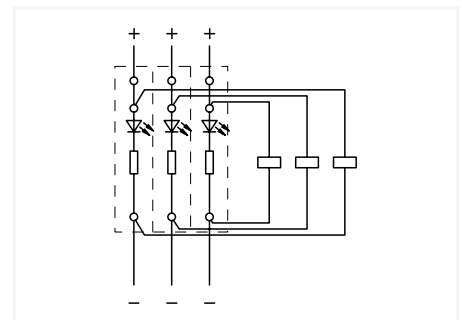

Circuit-related voltage indications can be created using the following terminal blocks:
 279-674/281-434 or 279-674/281-413

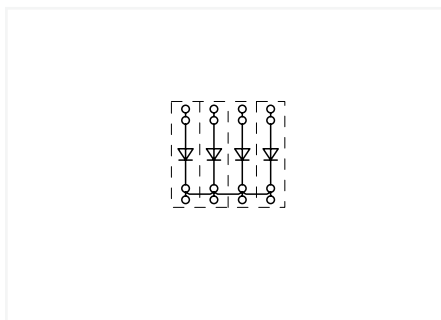

Polarized diode gates with a common cathode can be created using the following terminal blocks:
 279-815/281-410 or 279-815/281-411

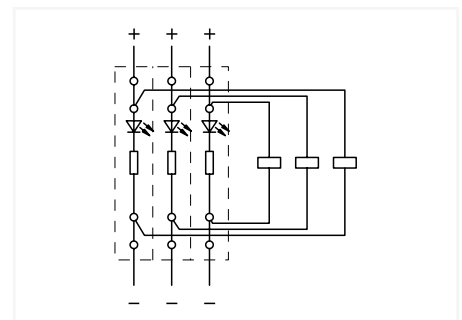

Circuit-related voltage indications can be created using the following terminal blocks:
 279-809/281-434 or 279-809/281-413

Diode Terminal Block and LED Terminal Block 2.5 mm²; 280 Series

Technical Data	
0.08 ... 2.5 mm ²	28 ... 14 AWG
U _N 250 V; U _{RM} 1000 V	
1N4007 – 0.5 A continuous current	
Terminal block width: 5 mm / 0.197 inch	
8 ... 9 mm / 0.31 ... 0.35 inch	

Technical Data	
0.08 ... 2.5 mm ²	28 ... 14 AWG
U _N 250 V; U _{RM} 1000 V	
1N4007 – 0.5 A continuous current	
Terminal block width: 5 mm / 0.197 inch	
8 ... 9 mm / 0.31 ... 0.35 inch	

Technical Data	
0.08 ... 2.5 mm ²	28 ... 14 AWG
24 VDC	
I _F 0.025 A max.	
Terminal block width: 5 mm / 0.197 inch	
8 ... 9 mm / 0.31 ... 0.35 inch	

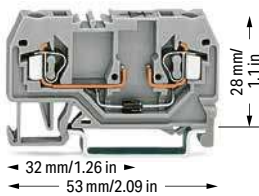

280-915/281-410 280-915/281-411

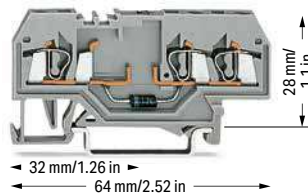

280-673/281-410 280-673/281-411

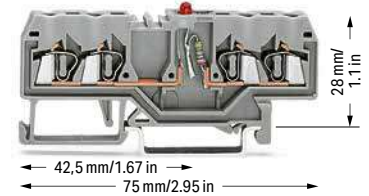

280-809/281-434 280-809/281-413

6

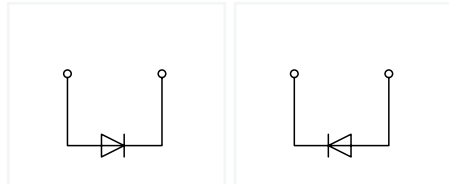

2-conductor diode terminal block; with 1N4007 diode; gray

	Item No.	Pack. Unit
○ anode left	280-915/281-410	100
○ anode right	280-915/281-411	100

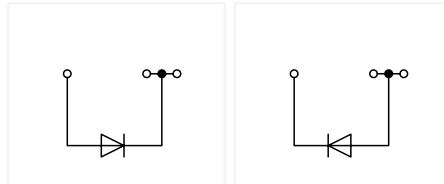

3-conductor diode terminal block; with 1N4007 diode; gray

	Item No.	Pack. Unit
○ anode left	280-673/281-410	100
○ anode right	280-673/281-411	100

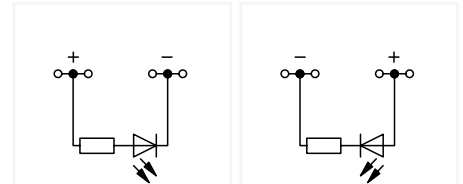

4-conductor LED terminal block; with red LED; gray

	Item No.	Pack. Unit
○ anode left	280-809/281-434	100
○ anode right	280-809/281-413	100

Other terminal blocks with the same profile:		
Through	280-901	Page 314

Other terminal blocks with the same profile:		
Through	280-681	Page 314

Other terminal blocks with the same profile:		
Through	280-833	Page 314

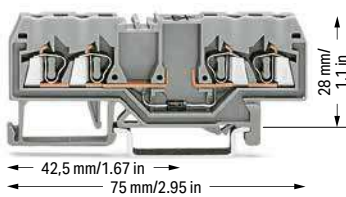

280-815/281-410 280-815/281-411

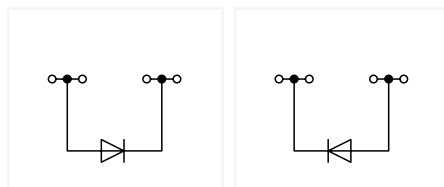

4-conductor diode terminal block; with 1N4007 diode; gray

	Item No.	Pack. Unit
○ anode left	280-815/281-410	100
○ anode right	280-815/281-411	100

Other terminal blocks with the same profile:		
Through	280-833	Page 314

Diode Terminal Blocks and LED Terminal Blocks

Circuit Configuration Examples

Please observe the application notes:
 Insulation stop, page 425
 Comb-style jumper bar, page 426
 Marking, from page 684

Approvals and corresponding ratings,
 visit www.wago.com

Accessories; 280 Series

Appropriate marking system:
 WMB/WMB Inline

Insulation stop; 0.08 ... 0.2 mm² "s" (0.14 mm² "f-st"); 5 pcs/strip

	white	280-470	200 (25)
---	-------	---------	----------

Insulation stop; 0.25 ... 0.5 mm²; 5 pcs/strip

	light gray	280-471	200 (25)
---	------------	---------	----------

Insulation stop; 0.75 ... 1 mm²; 5 pcs/strip

	dark gray	280-472	200 (25)
---	-----------	---------	----------

Comb-style jumper bar; insulated; I_N = I_N of terminal block

	2-way	280-482	200 (25)
	3-way	280-483	200 (25)

Comb-style jumper bar; insulated; I_N = I_N of terminal block

	10-way	280-490	50 (25)
---	--------	---------	---------

Alternate comb-style jumper bar; insulated; I_N = I_N of terminal block

	2-way	280-492	200 (25)
---	-------	---------	----------

Operating tool; insulated

	2-way	280-432	1
	3-way	280-433	1

Operating tool; insulated

	10-way	280-440	1
---	--------	---------	---

Wire commoning chain; insulated; 50 connections; I_N 8 A

	black	210-103	5
---	-------	---------	---

Wire commoning chain; insulated; 50 connections; I_N 8 A

	blue	210-123	5
---	------	---------	---

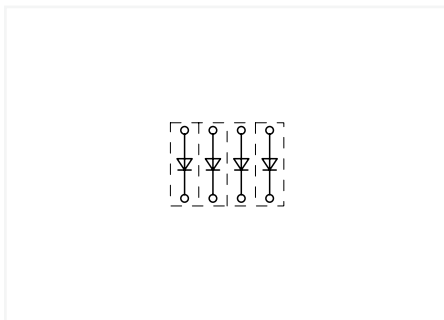

Open diode gates can be created using the following terminal blocks:
 280-915/281-410 or 280-915/281-411



These diode terminal blocks have been specially developed for custom diode circuits, such as lamp test and collective fault signal circuits.

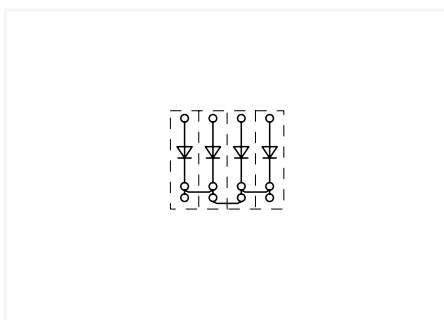

Polarized diode gates with a common cathode can be created using the following terminal blocks:
 280-673/281-410 or 280-673/281-411

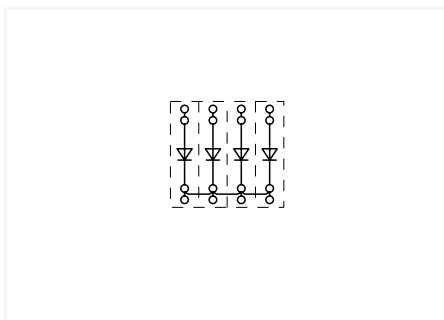

Polarized diode gates with a common cathode can be created using the following terminal blocks:
 280-815/281-410 or 280-815/281-411

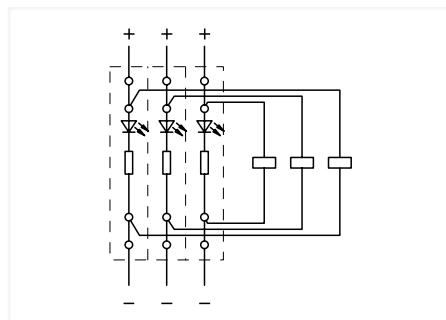

Circuit-related voltage indications can be created using the following terminal blocks:
 280-809/281-434 or 280-809/281-413

Diode Terminal Block

4 mm²; 281 Series

Technical Data	
0.08 ... 4 mm ²	28 ... 12 AWG
U _N 250 V; U _{RM} 1000 V	
Terminal block width: 6 mm / 0.236 inch	
9 ... 10 mm / 0.35 ... 0.39 inch	

Technical Data	
0.08 ... 4 mm ²	28 ... 12 AWG
U _N 250 V; U _{RM} 1000 V	
Terminal block width: 6 mm / 0.236 inch	
9 ... 10 mm / 0.35 ... 0.39 inch	

Technical Data	
0.08 ... 4 mm ²	28 ... 12 AWG
U _N 250 V; U _{RM} 1000 V	
Terminal block width: 6 mm / 0.236 inch	
9 ... 10 mm / 0.35 ... 0.39 inch	

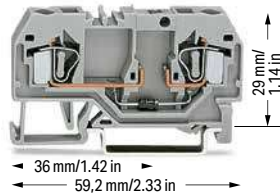

281-915/281-410 281-915/281-411

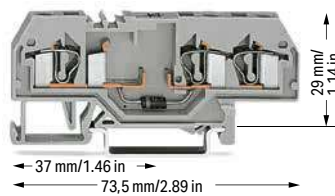

281-673/281-410 281-673/281-411

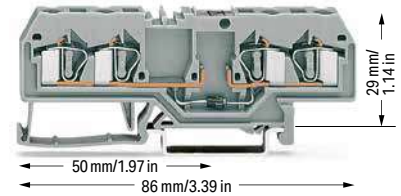

281-665/281-410 281-665/281-410

6

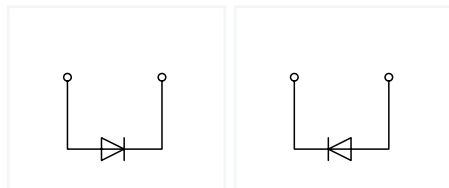

2-conductor diode terminal block; with 1N4007 diode; 0.5 A continuous current; gray

	Item No.	Pack. Unit
○ anode left	281-915/281-410	50
○ anode right	281-915/281-411	50

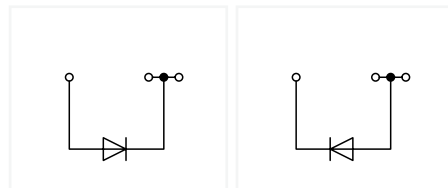

3-conductor diode terminal block; with 1N4007 diode; 0.5 A continuous current; gray

	Item No.	Pack. Unit
○ anode left	281-673/281-410	50
○ anode right	281-673/281-411	50

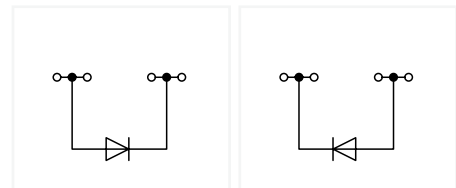

4-conductor diode terminal block; with 1N4007 diode; 0.5 A continuous current; gray

	Item No.	Pack. Unit
○ anode left	281-665/281-410	50
○ anode right	281-665/281-411	50

2-conductor diode terminal block; with 1N5408 diode; 1.5 A continuous current; gray

	Item No.	Pack. Unit
○ anode left	281-915/281-400	50
○ anode right	281-915/281-401	50

3-conductor diode terminal block; with 1N5408 diode; 1.5 A continuous current; gray

	Item No.	Pack. Unit
○ anode left	281-673/281-400	50
○ anode right	281-673/281-401	50

4-conductor diode terminal block; with 1N5408 diode; 1.5 A continuous current; gray

	Item No.	Pack. Unit
○ anode left	281-665/281-400	50
○ anode right	281-665/281-401	50

Other terminal blocks with the same profile:		
Through	281-901	Page 318

Other terminal blocks with the same profile:		
Through	281-681	Page 318

Other terminal blocks with the same profile:		
Through	280-652	Page 318

Diode Terminal Blocks Circuit Configuration Examples

Please observe the application notes:
Insulation stop, page 425
Comb-style jumper bar, page 426
Marking, from page 684

Approvals and corresponding ratings,
visit www.wago.com

Accessories; 281 Series
Appropriate marking system:
WMB

Insulation stop; 0.08 ... 0.2 mm² "s" (0.14 mm² "f-st"); 5 pcs/strip

	white	281-470	200 (25)
---	-------	---------	----------

Insulation stop; 0.25 ... 0.5 mm²; 5 pcs/strip

	light gray	281-471	200 (25)
---	------------	---------	----------

Insulation stop; 0.75 ... 1.5 mm²; 5 pcs/strip

	dark gray	281-472	200 (25)
---	-----------	---------	----------

Comb-style jumper bar; insulated; I_N = I_N of terminal block

	2-way	281-482	100 (25)
	3-way	281-483	100 (25)
	5-way	281-485	100 (25)
	10-way	281-490	50 (25)

Alternate comb-style jumper bar; insulated; I_N = I_N of terminal block

	2-way	281-492	100 (25)
---	-------	---------	----------

Operating tool; insulated

	2-way	280-432	1
	3-way	280-433	1
	5-way	281-440	1

Wire commoning chain; insulated; 50 connections; I_N 8 A

	black	210-103	5
---	-------	---------	---

Wire commoning chain; insulated; 50 connections; I_N 8 A

	blue	210-123	5
---	------	---------	---

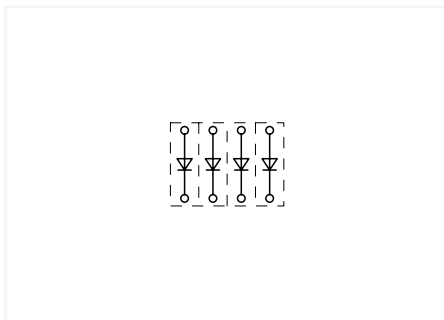

Open diode gates can be created using the following terminal blocks:
281-915/281-410 or 281-915/281-411

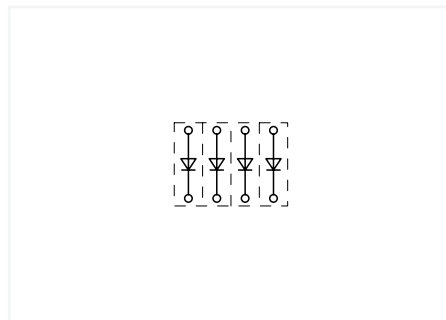

Open diode gates can be created using the following terminal blocks:
281-915/281-400 or 281-915/281-401

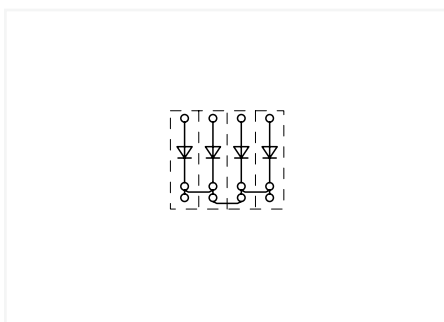

Polarized diode gates with a common cathode can be created using the following terminal blocks:
281-673/281-410 or 281-673/281-411

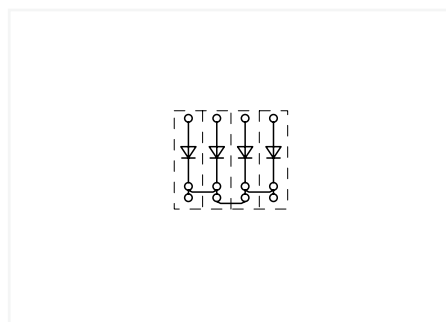

Polarized diode gates with a common cathode can be created using the following terminal blocks:
281-673/281-400 or 281-673/281-401

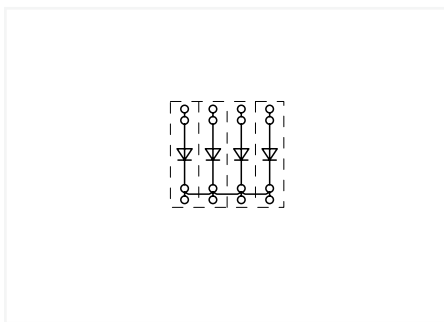

Polarized diode gates with a common cathode can be created using the following terminal blocks:
281-665/281-410 or 281-665/281-411

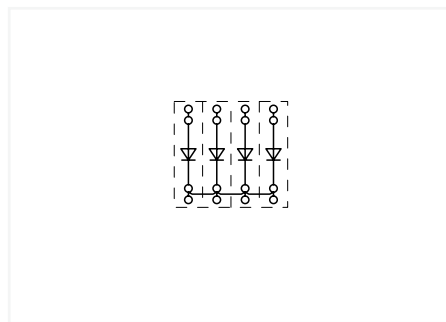

Polarized diode gates with a common cathode can be created using the following terminal blocks:
281-665/281-400 or 281-665/281-401

Double-Deck Diode Terminal Block and LED Terminal Block 2.5 mm²; 280 Series

Technical Data

0.08 ... 2.5 mm² | 28 ... 14 AWG

U_N 250 V; U_{RM} 1000 V

1N4007 – 0.5 A continuous current

Terminal block width: 5 mm / 0.197 inch

 8 ... 9 mm / 0.31 ... 0.35 inch

Technical Data

0.08 ... 2.5 mm² | 28 ... 14 AWG

U_N 250 V; U_{RM} 1000 V

1N4007 – 0.5 A continuous current

Terminal block width: 5 mm / 0.197 inch

 8 ... 9 mm / 0.31 ... 0.35 inch

Technical Data

0.08 ... 2.5 mm² | 28 ... 14 AWG

24 VDC

I_F 0.025 A max.

Terminal block width: 5 mm / 0.197 inch

 8 ... 9 mm / 0.31 ... 0.35 inch

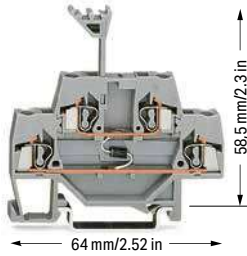

64 mm/2.52 in

280-940/281-410

280-940/281-411

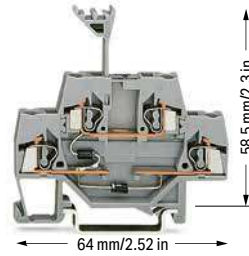

64 mm/2.52 in

280-941/281-492

280-941/281-491

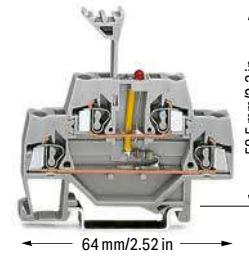

64 mm/2.52 in

280-943/281-434

280-943/281-413

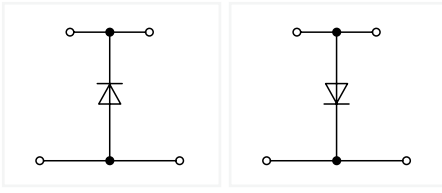

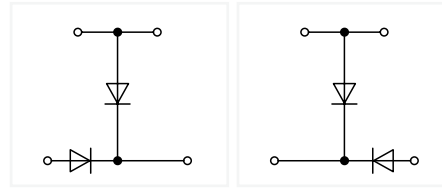

Double-deck diode terminal block; with 1N4007 diode; gray

	Item No.	Pack. Unit
	280-940/281-410	50
	280-940/281-411	50



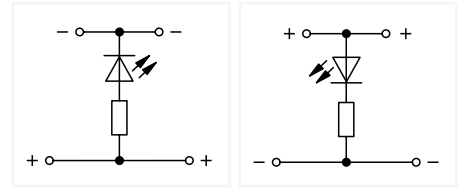

Double-deck diode terminal block; with two 1N4007 diodes; gray

	Item No.	Pack. Unit
	280-941/281-492	50
	280-941/281-491	50



Double-deck LED terminal block; with red LED; gray

	Item No.	Pack. Unit
	280-943/281-434	50
	280-943/281-413	50

Other terminal blocks with the same profile:

Through	280-519	Page 292
---------	---------	----------

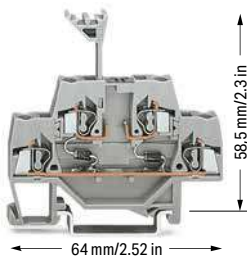

64 mm/2.52 in

280-942/281-487

280-942/281-488

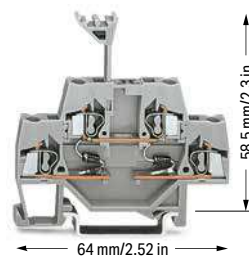



64 mm/2.52 in

280-941/281-489

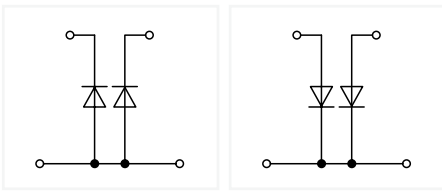
280-941/281-490



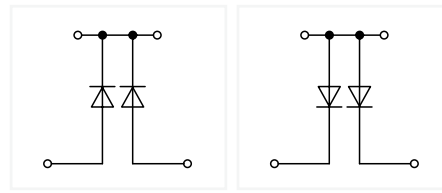

Double-deck diode terminal block; with two 1N4007 diodes; gray

	Item No.	Pack. Unit
	280-942/281-487	50
	280-942/281-488	50



Double-deck diode terminal block; with two 1N4007 diodes; gray

	Item No.	Pack. Unit
	280-941/281-489	50
	280-941/281-490	50



Double-Deck Diode Terminal Blocks and LED Terminal Blocks Circuit Configuration Examples

Please observe the application notes:
Insulation stop, page 425
Comb-style jumper bar, page 426
Marking, from page 684

Approvals and corresponding ratings,
visit www.wago.com

Accessories; 280 Series
Appropriate marking system:
WMB

End and intermediate plate; 2.5 mm thick

	orange	280-341	100 (25)
	gray	280-340	100 (25)

Insulation stop; 0.08 ... 0.2 mm² "s" (0.14 mm² "f-st"); 5 pcs/strip

	white	280-470	200 (25)
---	-------	---------	----------

Insulation stop; 0.25 ... 0.5 mm²; 5 pcs/strip

	light gray	280-471	200 (25)
---	------------	---------	----------

Insulation stop; 0.75 ... 1 mm²; 5 pcs/strip

	dark gray	280-472	200 (25)
---	-----------	---------	----------

Comb-style jumper bar; insulated; I_N = I_N of terminal block

	2-way	280-482	200 (25)
	3-way	280-483	200 (25)

Comb-style jumper bar; insulated; I_N = I_N of terminal block

	10-way	280-490	50 (25)
---	--------	---------	---------

Alternate comb-style jumper bar; insulated; I_N = I_N of terminal block

	2-way	280-492	200 (25)
---	-------	---------	----------

Operating tool; insulated

	2-way	280-432	1
	3-way	280-433	1

Operating tool; insulated

	10-way	280-440	1
---	--------	---------	---

Wire commoning chain; insulated; 50 connections; I_N 8 A

	black	210-103	5
---	-------	---------	---

Wire commoning chain; insulated; 50 connections; I_N 8 A

	blue	210-123	5
---	------	---------	---

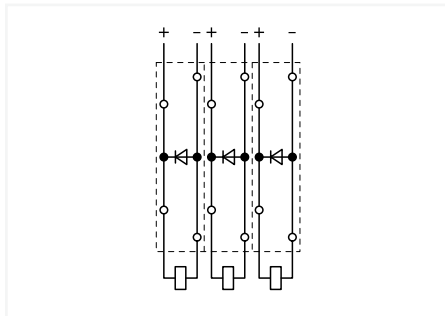

Recovery diodes can be created using the following terminal blocks:
280-940/281-410 or 280-940/281-411

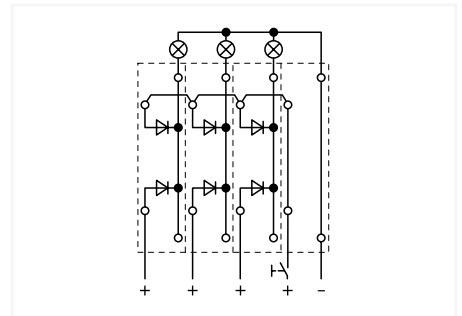

Lamp test circuits can be created using the following terminal blocks:
280-942/281-487 or 280-942/281-488

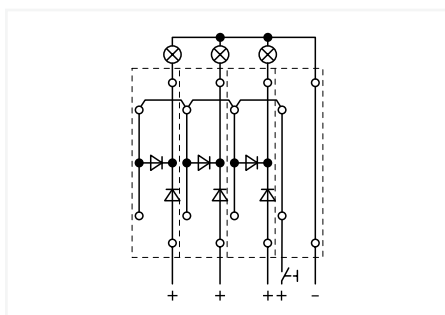

Lamp test circuits can be created using the following terminal blocks:
280-941/281-492 or 280-941/281-491

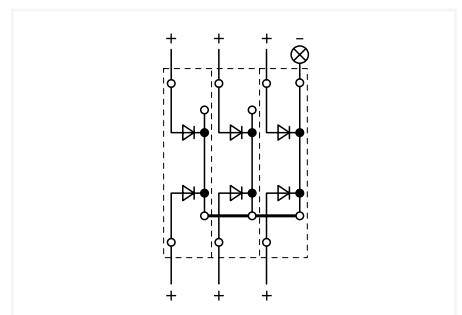

Collective fault signals can be created using the following terminal blocks:
280-941/281-489 or 280-941/281-490

Double-deck diode terminal blocks were specifically developed for custom diode circuits, such as lamp test and collective fault signal circuits. Using LED terminal blocks, monitoring units can be designed, e.g., for control and operating circuits. These terminal blocks provide high-density wiring in a width of just 5 mm.

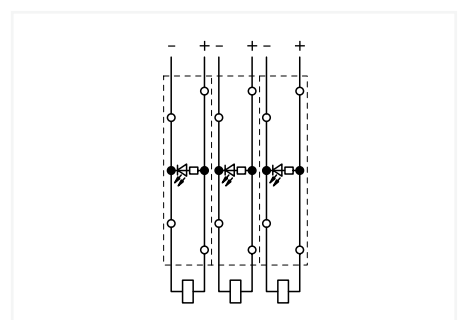

Circuit-related voltage indications can be created using the following terminal blocks:
280-943/281-434 or 280-943/281-413

Double-Deck Diode Terminal Block and LED Terminal Block 4 mm²; 281 Series

Technical Data

0.08 ... 4 mm² | 28 ... 12 AWG
 U_N 250 V; U_{RM} 1000 V
 1N4007 – 0.5 A continuous current
 Terminal block width: 6 mm / 0.236 inch
 9 ... 10 mm / 0.35 ... 0.39 inch

Technical Data

0.08 ... 4 mm² | 28 ... 12 AWG
 U_N 250 V; U_{RM} 1000 V
 1N4007 – 0.5 A continuous current
 Terminal block width: 6 mm / 0.236 inch
 9 ... 10 mm / 0.35 ... 0.39 inch

Technical Data

0.08 ... 4 mm² | 28 ... 12 AWG
 24 VDC
 I_F 0.025 A max.
 Terminal block width: 6 mm / 0.236 inch
 9 ... 10 mm / 0.35 ... 0.39 inch

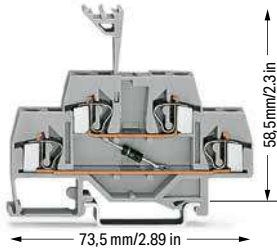

281-633/281-410

281-633/281-411

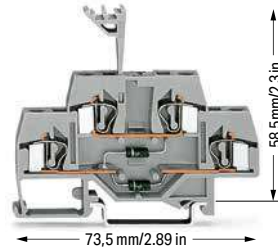

281-635/281-492

281-635/281-491

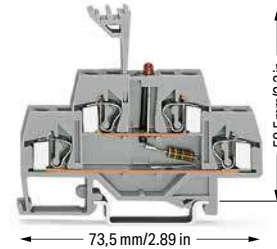

281-634/281-434

281-634/281-413

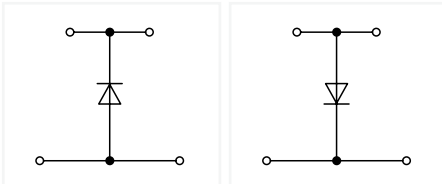

Double-deck diode terminal block; with 1N4007 diode; gray

	Item No.	Pack. Unit
○ anode bottom	281-633/281-410	50
○ anode top	281-633/281-411	50

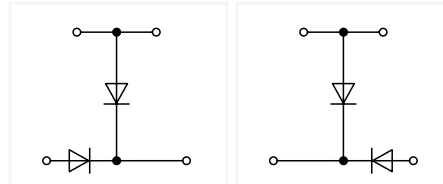

Double-deck diode terminal block; with two 1N4007 diodes; gray

	Item No.	Pack. Unit
○ anode top, anode left	281-635/281-492	50
○ anode top, anode right	281-635/281-491	50

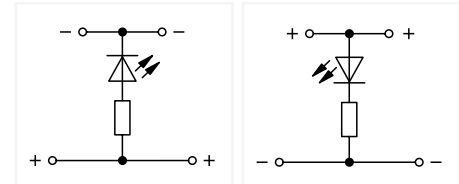

Double-deck LED terminal block; with red LED; gray

	Item No.	Pack. Unit
○ anode bottom	281-634/281-434	50
○ anode top	281-634/281-413	50

Other terminal blocks with the same profile:

Through	281-619	Page 296
---------	---------	----------

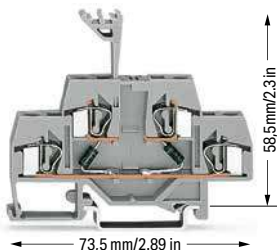

281-636/281-487

281-636/281-488

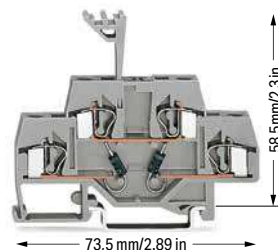

281-635/281-489

281-635/281-490

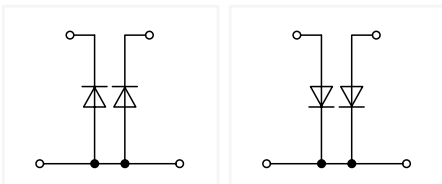

Double-deck diode terminal block; with two 1N4007 diodes; gray

	Item No.	Pack. Unit
○ anodes bottom	281-636/281-487	50
○ anodes top	281-636/281-488	50

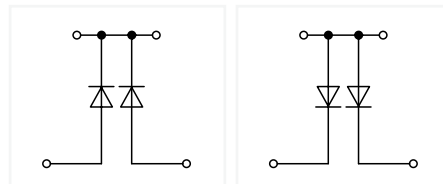

Double-deck diode terminal block; with two 1N4007 diodes; gray

	Item No.	Pack. Unit
○ anodes bottom	281-635/281-489	50
○ anodes top	281-635/281-490	50

Double-Deck Diode Terminal Blocks and LED Terminal Blocks Circuit Configuration Examples

Please observe the application notes:
Insulation stop, page 425
Comb-style jumper bar, page 426
Marking, from page 684

Approvals and corresponding ratings,
visit www.wago.com

Accessories; 280 Series
Appropriate marking system:
WMB

End and intermediate plate; 2.5 mm thick

	orange	281-341	100 (25)
	gray	281-340	100 (25)

Insulation stop; 0.08 ... 0.2 mm² "s" (0.14 mm² "f-st"); 5 pcs/strip

	white	281-470	200 (25)
---	-------	---------	----------





Insulation stop; 0.25 ... 0.5 mm²; 5 pcs/strip

	light gray	281-471	200 (25)
---	------------	---------	----------

Insulation stop; 0.75 ... 1.5 mm²; 5 pcs/strip

	dark gray	281-472	200 (25)
---	-----------	---------	----------



Comb-style jumper bar; insulated; I_N = I_N of terminal block

	2-way	281-482	100 (25)
	3-way	281-483	100 (25)
	5-way	281-485	100 (25)
	10-way	281-490	50 (25)

Alternate comb-style jumper bar; insulated; I_N = I_N of terminal block

	2-way	280-492	200 (25)
---	-------	---------	----------

Operating tool; insulated

	2-way	280-432	1
	3-way	280-433	1
	5-way	281-440	1

Wire commoning chain; insulated; 50 connections; I_N 8 A

	black	210-103	5
---	-------	---------	---

Wire commoning chain; insulated; 50 connections; I_N 8 A

	blue	210-123	5
---	------	---------	---

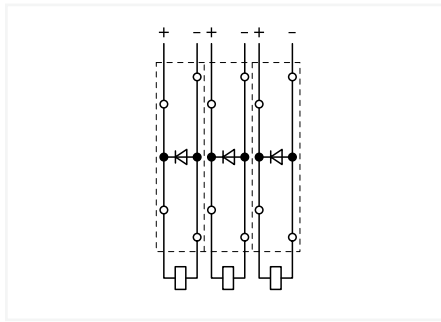

Recovery diodes can be created using the following terminal blocks:
281-633/281-410 or 281-633/281-411

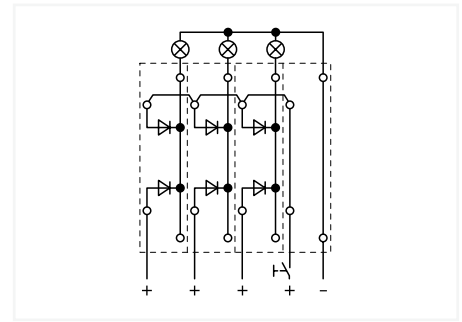

Lamp test circuits can be created using the following terminal blocks:
281-636/281-487 or 281-636/281-488

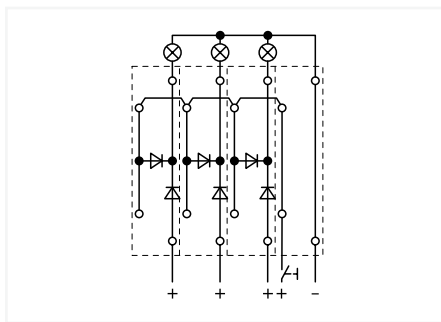

Lamp test circuits can be created using the following terminal blocks:
281-635/281-492 or 281-635/281-491

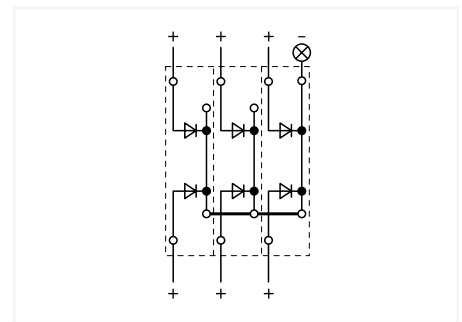

Collective fault signals can be created using the following terminal blocks:
281-635/281-489 or 281-635/281-490

Double-deck diode terminal blocks were specifically developed for custom diode circuits, such as lamp test and collective fault signal circuits. Using LED terminal blocks, monitoring units can be designed, e.g., for control and operating circuits. These terminal blocks provide high-density wiring in a width of just 6 mm.

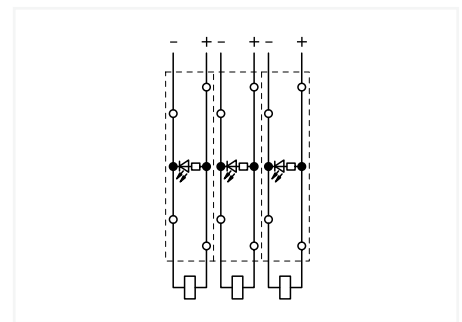

Circuit-related voltage indications can be created using the following terminal blocks:
281-634/281-434 or 281-634/281-413

Pluggable Diode Module on Carrier Terminal Block 2.5 mm² 280 Series

Technical Data

U_N 250 V; U_{RM} 1000 V
 I_N 0.5 A
 Plug width: 5 mm / 0.197 inch



*12 AWG: THHN, THWN

Please observe the application notes:
 Insulation stop, page 425
 Comb-style jumper bar, page 426
 Marking, from page 684

Approvals and corresponding ratings, visit www.wago.com

Accessories; 280 Series

Appropriate marking system:
 WMB

Insulation stop; 0.08 ... 0.2 mm² "s" (0.14 mm² "f-st"); 5 pcs/strip

white	280-470	200 (25)
-------	---------	----------

Insulation stop; 0.25 ... 0.5 mm²; 5 pcs/strip

light gray	280-471	200 (25)
------------	---------	----------

Insulation stop; 0.75 ... 1 mm²; 5 pcs/strip

dark gray	280-472	200 (25)
-----------	---------	----------

Comb-style jumper bar; insulated; I_N = I_N of terminal block

2-way	280-482	200 (25)
3-way	280-483	200 (25)

Comb-style jumper bar; insulated; I_N = I_N of terminal block

10-way	280-490	50 (25)
--------	---------	---------

Alternate comb-style jumper bar; insulated; I_N = I_N of terminal block

2-way	280-492	200 (25)
-------	---------	----------

Operating tool; insulated

2-way	280-432	1
3-way	280-433	1

Operating tool; insulated

10-way	280-440	1
--------	---------	---

Wire commoning chain; insulated; 50 connections; I_N 8 A

black	210-103	5
-------	---------	---

Wire commoning chain; insulated; 50 connections; I_N 8 A

blue	210-123	5
------	---------	---

280-801/281-411

280-801/281-420

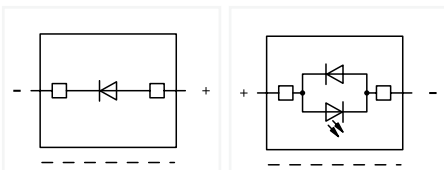

Diode module; with 1N4007 diode; 5 mm wide; gray

	Item No.	Pack. Unit
○ anode right	280-801/281-411	100

Diode module; with 1N4007 recovery diode; red LED; 5 mm wide; gray

○ 24 VDC	280-801/281-420	100
○ 48 VDC	280-801/281-421	100

Accessories; Carrier Terminal Blocks

Appropriate marking system:
 WMB

2-conductor carrier terminal block; 0.08 ... 2.5 mm² / 28 ... 12 AWG*
 Terminal block width: 5 mm / 0.197 inch

gray	280-916	100
------	---------	-----

End and intermediate plate; 2.5 mm thick

orange	280-309	100 (25)
gray	280-308	100 (25)

3-conductor carrier terminal block; 0.08 ... 2.5 mm² / 28 ... 12 AWG*
 Terminal block width: 5 mm / 0.197 inch

gray	280-610	100
------	---------	-----

End and intermediate plate; 2.5 mm thick

orange	280-326	100 (25)
gray	280-324	100 (25)

4-conductor carrier terminal block; 0.08 ... 2.5 mm² / 28 ... 12 AWG*
 Terminal block width: 5 mm / 0.197 inch

gray	280-816	100
------	---------	-----

End and intermediate plate; 2.5 mm thick

orange	280-315	100 (25)
gray	280-314	100 (25)

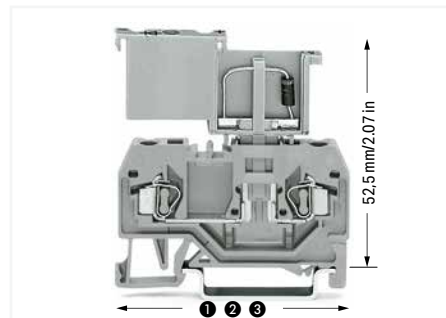

Lengths of carrier terminal blocks with a pluggable diode module:

- ① 53 mm / 2.09 inch for 280-916
- ② 64 mm / 2.52 inch for 280-610
- ③ 75 mm / 2.95 inch for 280-816

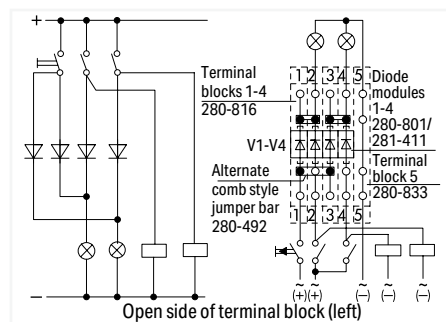

Lamp test circuit with blocking diodes

These diode modules are ideal for custom diode circuits (e.g., lamp test and collective fault signal circuits) and offer the following advantages:

- Separation into functional and wiring levels
- Polarized switching direction
- Quick and easy module replacement
- Terminal blocks/modules provide high-density wiring in a width of just 5 mm

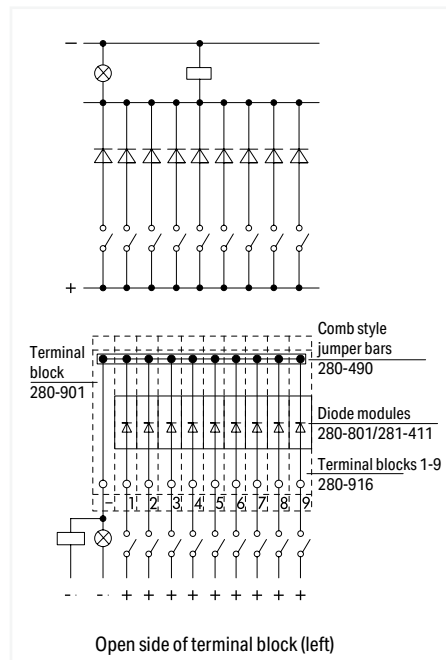

Diode gate for collective fault indication

6

Pluggable Diode Module on Through Terminal Block 2.5 mm² 280 Series

Technical Data

U_N 250 V; U_{RM} 1000 V
 I_N 0.5 A
 Plug width: 10 mm / 0.394 inch



280-803/281-411

280-803/281-420

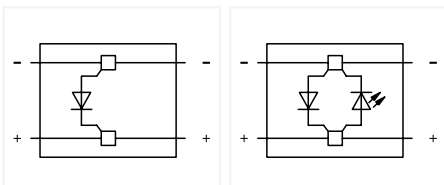

Diode module; with 1N4007 diode; 10 mm wide; gray

	Item No.	Pack. Unit
○ anode right	280-803/281-411	50

Diode module; with 1N4007 recovery diode; red LED; 10 mm wide; gray

○ 24 VDC	280-803/281-420	50
----------	-----------------	----

Accessories; Through Terminal Blocks

Appropriate marking system:
WMB

2-conductor through terminal block;
0.08 ... 2.5 mm² / 28 ... 12 AWG*
Terminal block width: 5 mm / 0.197 inch

gray	280-901	100
------	---------	-----

End and intermediate plate; 2.5 mm thick

orange	280-309	100 (25)
gray	280-308	100 (25)

3-conductor through terminal block;
0.08 ... 2.5 mm² / 28 ... 12 AWG*
Terminal block width: 5 mm / 0.197 inch

gray	280-681	100
------	---------	-----

End and intermediate plate; 2.5 mm thick

orange	280-326	100 (25)
gray	280-324	100 (25)

4-conductor through terminal block;
0.08 ... 2.5 mm² / 28 ... 12 AWG*
Terminal block width: 5 mm / 0.197 inch

gray	280-833	100
------	---------	-----

End and intermediate plate; 2.5 mm thick

orange	280-315	100 (25)
gray	280-314	100 (25)

*12 AWG: THHN, THWN

Please observe the application notes:
Insulation stop, page 425
Comb-style jumper bar, page 426
Marking, from page 684

Approvals and corresponding ratings,
visit www.wago.com

Accessories; 280 Series

Appropriate marking systems:
WMB/WMB Inline/WFB

2-conductor through terminal block;
0.08 ... 2.5 mm² / 28 ... 12 AWG*
Terminal block width: 5 mm / 0.197 inch

gray	280-101	100
------	---------	-----

End and intermediate plate; 2.5 mm thick

orange	280-302	100 (25)
gray	280-301	100 (25)

Insulation stop; 0.08 ... 0.2 mm² "s" (0.14 mm² "f-st"); 5 pcs/strip

white	280-470	200 (25)
-------	---------	----------

Insulation stop; 0.25 ... 0.5 mm²; 5 pcs/strip

light gray	280-471	200 (25)
------------	---------	----------

Insulation stop; 0.75 ... 1 mm²; 5 pcs/strip

dark gray	280-472	200 (25)
-----------	---------	----------

Adjacent jumper; insulated; I_N = I_N terminal block

gray	280-402	200 (25)
------	---------	----------

Wire commoning chain; insulated; 50 connections; I_N 8 A

black	210-103	5
-------	---------	---

Wire commoning chain; insulated; 50 connections; I_N 8 A

blue	210-123	5
------	---------	---

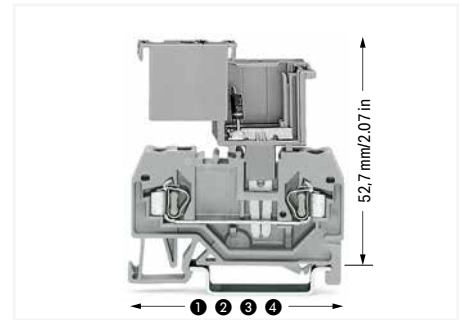

Lengths of through terminal blocks with a pluggable diode module:

- ① 53 mm / 2.09 inch for 280-901
- ② 64 mm / 2.52 inch for 280-681
- ③ 75 mm / 2.95 inch for 280-833
- ④ 45.5 mm / 1.67 inch for 280-101



Similar to push-in type jumpers, these diode modules are simply pushed into the current bar's contact slots of two adjacent through terminal blocks, providing the following advantages:

- Compatibility with all 280 Series Through Terminal Blocks
- Easy retrofits for existing systems
- Separation into functional and wiring levels
- Fast replacement of other functional units

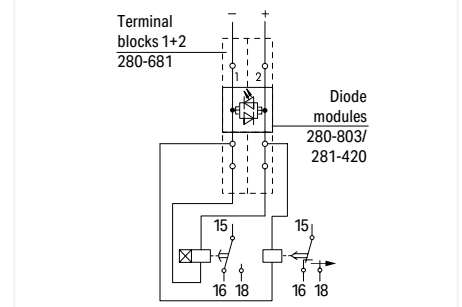
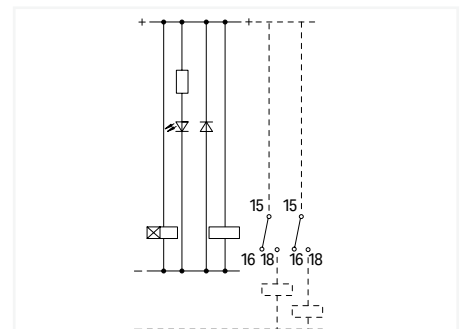

Free-wheeling diode and voltage check

Pluggable LED and Neon Indicator Module on Carrier Terminal Block 2.5 mm² 280 Series

Technical Data

Plug width: 5 mm / 0.197 inch

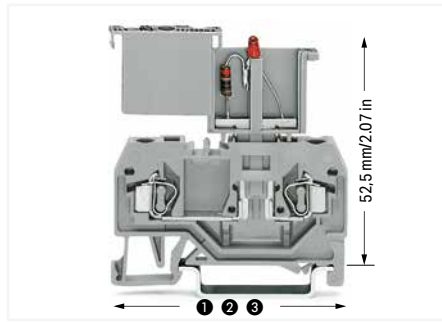

Lengths of carrier terminal blocks with a pluggable diode module:

- ❶ 53 mm / 2.09 inch for 280-916
- ❷ 64 mm / 2.52 inch for 280-610
- ❸ 75 mm / 2.95 inch for 280-816

LED module; with red LED; 5 mm wide; I_N 5.6 mA; I_F 25 mA; gray

	Item No.	Pack. Unit
○ 24 VDC	280-801/281-413	100
○ 48 VDC	280-801/281-414	100

LED module; with red LED; 5 mm wide; I_N 5.6 mA; I_F 25 mA; gray

○ 24 VAC/DC	280-801/281-415	100
○ 48 VAC/VDC	280-801/281-416	100

Neon indicator module; 5 mm wide; I_N 0.5 mA; gray

○ 120 VAC/VDC	280-801/281-418	100
○ 230 VAC/VDC	280-801/281-417	100

Carrier terminal blocks, see page 374

Circuit Diagrams

LED module

	24 VDC	280-801/281-413
	48 VDC	280-801/281-414

LED module

	24 VAC/DC	280-801/281-415
	48 VAC/VDC	280-801/281-416

Neon indicator module

	120 VAC/VDC	280-801/281-418
	230 VAC/VDC	280-801/281-417



The monitoring of control and operating current circuits with LED modules on rail-mount terminal blocks provides several advantages:

- No additional cost for assembly and wiring
- Separation into functional and wiring levels
- Modules can be replaced quickly by other types of modules
- Polarized switching direction
- Terminal blocks/modules provide high-density wiring in a width of just 5 mm

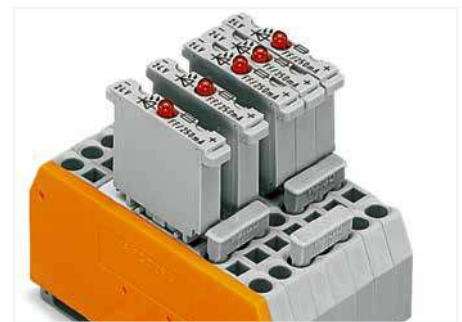

Carrier terminal blocks with component plugs, alternate comb-style jumper bars, 3-way, comb-style jumper bar

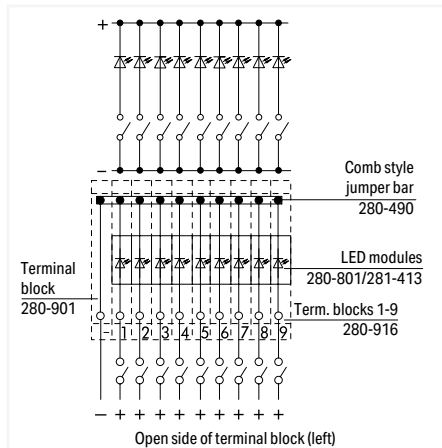

LED gate for collective fault indication – individual display

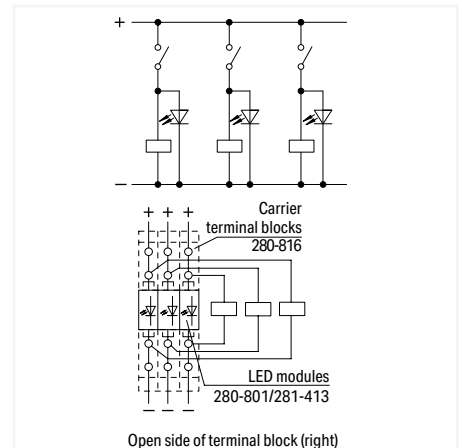

Voltage control assigned to current circuits

Pluggable LED and Neon Indicator Module on Through Terminal Block 2.5 mm² 280 Series

Technical Data

Plug width: 10 mm / 0.394 inch

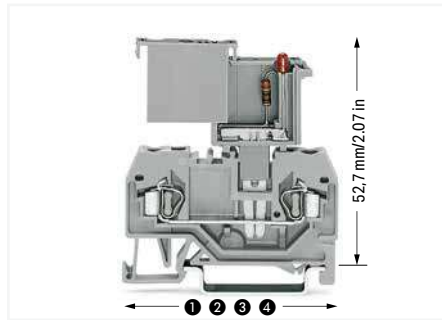

Lengths of through terminal blocks with a pluggable diode module:

- ❶ 53 mm / 2.09 inch for 280-901
- ❷ 64 mm / 2.52 inch for 280-681
- ❸ 75 mm / 2.95 inch for 280-833
- ❹ 45.5 mm / 1.67 inch for 280-101

LED module; with red LED; 10 mm wide; I_V 5.6 mA; I_F 25 mA; gray

	Item No.	Pack. Unit
○ 24 VDC	280-803/281-413	100
○ 48 VDC	280-803/281-414	100

LED module; with red LED; 10 mm wide; I_V 5.6 mA; I_F 25 mA; gray

○ 24 VAC/DC	280-803/281-415	100
○ 48 VAC/VDC	280-803/281-416	100

Neon indicator module; 10 mm wide; I_V 0.5 mA; gray

○ 120 VAC/VDC	280-803/281-418	100
○ 230 VAC/VDC	280-803/281-417	100

Through terminal blocks, see page 375

Circuit Diagrams

LED module

	24 VDC	280-803/281-413
	48 VDC	280-803/281-414

LED module

	24 VAC/DC	280-803/281-415
	48 VAC/VDC	280-803/281-416

Neon indicator module

	120 VAC/VDC	280-803/281-418
	230 VAC/VDC	280-803/281-417



Similar to push-in type jumpers, these LED and neon indicator modules are simply pushed into the current bar's contact slots of two adjacent through terminal blocks, providing the following advantages:

- Compatibility with all 280 Series Through Terminal Blocks
- Easy retrofits for existing systems
- Separation into functional and wiring levels
- Fast replacement of other functional units

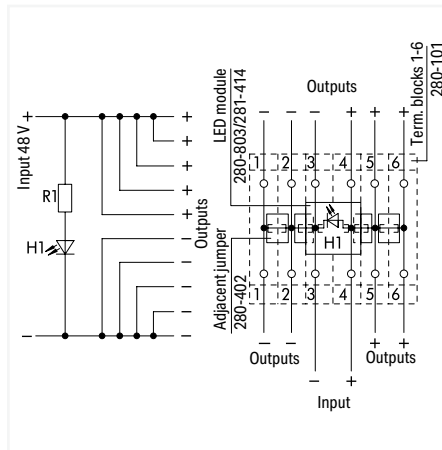

Multiple outputs with indicator lamp

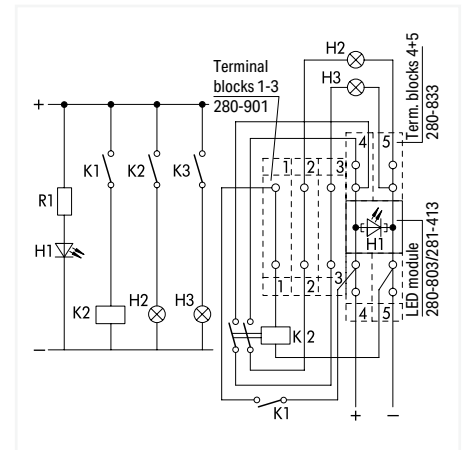

Control unit

L-Type Test Plug Module for Testing 5 mm or 6 mm Wide Rail-Mount Terminal Blocks via Conductor Entry

249 Series

Technical Data	
0.08 ... 1.5 mm ²	28 ... 16 AWG
Test voltage: 630 V	Test current: 6 A
Module width: 5 mm / 0.197 inch	
This test plug is not suitable for Ex e applications.	



Technical Data	
0.08 ... 2.5 mm ²	28 ... 14 AWG
Test voltage: 630 V	Test current: 6 A
Module width: 6 mm / 0.236 inch	
This test plug is not suitable for Ex e applications.	

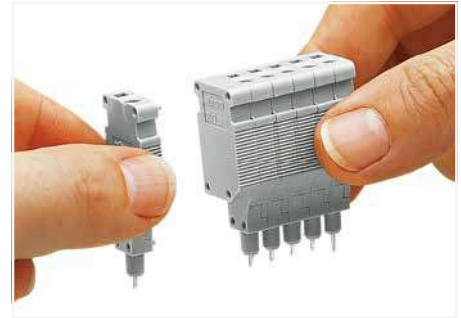

Snapping test plug and spacer modules together to assemble a multipole test plug module (max. 10 poles).

L-type test plug module; with spring-loaded contact pin; center module; snaps together
Module width: 5 mm

Color	Item No.	Pack. Unit
○ gray	249-141	100 (25)

L-type test plug module; with spring-loaded contact pin; center module; snaps together
Module width: 6 mm

Color	Item No.	Pack. Unit
○ gray	249-144	100 (25)

L-type end test plug module; with rigid contact pin; end module; snaps together
Module width: 5 mm

○ gray	249-142	100 (25)
--------	---------	----------

L-type end test plug module; with rigid contact pin; end module; snaps together
Module width: 6 mm

○ gray	249-145	100 (25)
--------	---------	----------

L-type spacer module; snaps together; bridges wired terminal blocks
Module width: 5 mm

○ gray	249-143	100 (25)
--------	---------	----------

L-type spacer module; snaps together; bridges wired terminal blocks
Module width: 6 mm

○ gray	249-146	100 (25)
--------	---------	----------

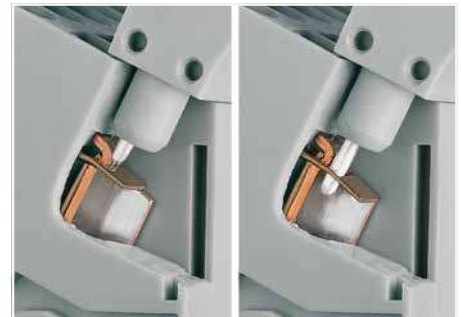

A = Center module with a spring-loaded contact pin
B = End module with a rigid contact pin

Accessories; for L-type test plug modules

Appropriate marking systems: WMB/WMB Inline/Mini-WSB/Mini-WSB Inline

WMB marking card; white; 10 strips with 10 markers/card; stretchable 5 ... 5.2 mm

plain	793-5501	5
-------	----------	---



Mini-WSB marking card; 10 strips with 10 markers/card; 5 mm wide markers

plain	248-501	5
-------	---------	---

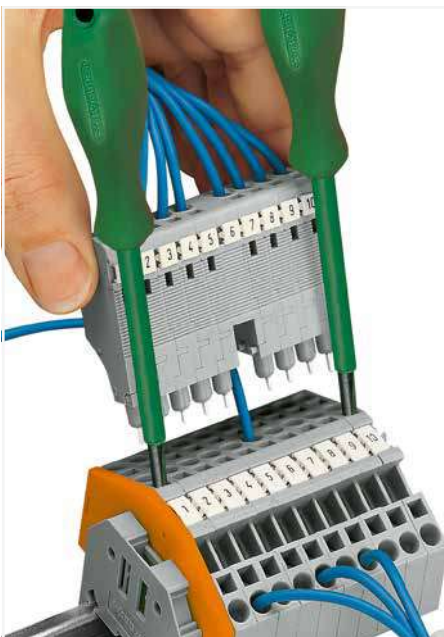

For easily testing terminal block assemblies, WAGO's L-type test plug modules with CAGE CLAMP® may be used on unwired terminal blocks. For testing, the module is assembled with spring-loaded pins in the center positions and rigid pin modules at the ends. The terminal blocks corresponding to the end position modules are opened using operating tools (as shown) – these rigid pins are then held in place by the CAGE CLAMP®.

The intermediate pins are spring-loaded and make contact with the current bars of the unwired clamping units. Clamping units needing to remain wired may be skipped by assembling a spacer in the test plug module.

Notice:
Mating direction must be observed (see picture).



CAGE CLAMP® connection
0.08 ... 1.5 mm²; 5 mm wide module
0.08 ... 2.5 mm²; 6 mm wide module

Power must be switched off when installing the test plug adapter. The safety guidelines for working on live installations must be observed.

B-Type Test Plug Module for Testing 5 mm or 6 mm Wide Rail-Mount Terminal Blocks via Jumper Contact Slot in Current Bar 249 Series

Technical Data	
0.08 ... 1.5 mm ²	28 ... 16 AWG
Test voltage: 630 V	Test current: 10 A
Module width: 5 mm / 0.197 inch	
This test plug is not suitable for Ex e applications.	



Technical Data	
0.08 ... 2.5 mm ²	28 ... 14 AWG
Test voltage: 630 V	Test current: 10 A
Module width: 6 mm / 0.236 inch	
This test plug is not suitable for Ex e applications.	



Snapping test plug and spacer modules together to assemble a multipole test plug module (max. 10 poles).

B-type test plug module; snaps together Module width: 5 mm		
Color	Item No.	Pack. Unit
○ gray	249-106	100 (25)

B-type test plug module; snaps together Module width: 6 mm		
Color	Item No.	Pack. Unit
○ gray	249-147	100 (25)

B-type spacer module; snaps together; bridges commoned terminal blocks, Module width: 5 mm		
Color	Item No.	Pack. Unit
○ gray	249-107	100 (25)

B-type spacer module; snaps together; bridges commoned terminal blocks, Module width: 6 mm		
Color	Item No.	Pack. Unit
○ gray	249-148	100 (25)

Accessories; for B-type test plug modules
Appropriate marking systems: WMB/WMB Inline/Mini-WSB/Mini-WSB Inline

WMB Inline, plain; 1,500 WMB markers (5 mm)/reel; 5 ... 5.2 mm stretchable			
Color	Item No.	Item No.	Pack. Unit
white	2009-115	1	

Mini-WSB Inline, plain; 1,700 Mini-WSB markers (5 mm wide) per reel; stretchable 5 ... 5.2 mm			
Color	Item No.	Item No.	Pack. Unit
white	2009-145	1	

WMB marking card; white; 10 strips with 10 markers/card; stretchable 5 ... 5.2 mm			
Color	Item No.	Item No.	Pack. Unit
plain	793-5501	5	

Mini-WSB marking card; 10 strips with 10 markers/card; 5 mm wide markers			
Color	Item No.	Item No.	Pack. Unit
plain	248-501	5	

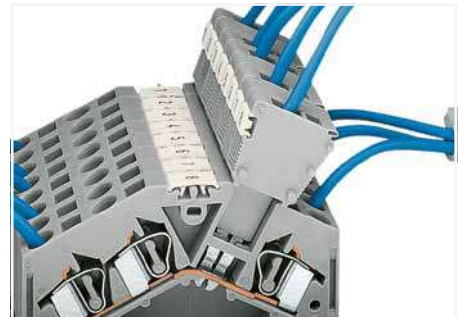

B-type test plugs are directly plugged into the jumper contact slot of the current bar.

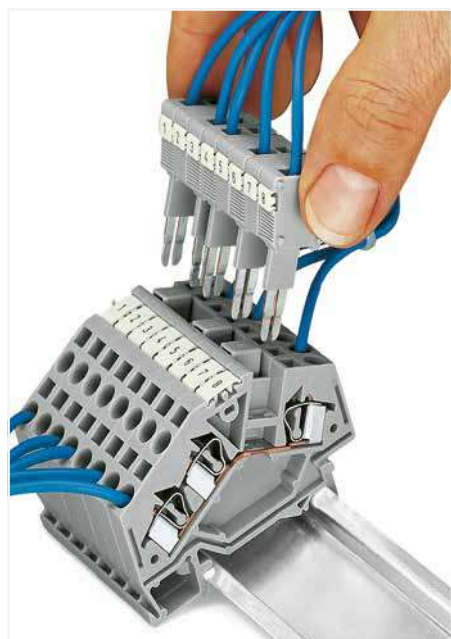

For testing individual circuits, offers a single-pole test plug accessory with CAGE CLAMP® up to 2.5 mm² (14 AWG) for direct contact with the current bar of a terminal block, or 1-pole test plug adapters for 4 mm Ø test plugs.

For serial testing on terminal block assemblies, has developed special multipole (max. 10-pole) modular test plug modules. WAGO's B-type test plug modules with CAGE CLAMP® connection are ideal for testing completely wired terminal blocks – even when using adjacent jumpers. For this testing type, the module assembly exactly matches the terminal block assembly. The test plug modules make direct contact to the jumper contact slots of the terminal blocks to be tested.



CAGE CLAMP® connection
0.08 ... 1.5 mm²; 5 mm wide module
0.08 ... 2.5 mm²; 6 mm wide module

Power must be switched off when installing the test plug adapter. The safety guidelines for working on live installations must be observed.

6

Test Plug Module for Testing 5 mm or 6 mm Wide Rail-Mount Terminal Blocks via Jumper Contact Slot in Current Bar

Technical Data	
Test voltage: 400 V	Test current: 6 A
Module width: 5 mm / 0.197 inch	
This test plug is not suitable for Ex e applications.	



Technical Data	
Test voltage: 400 V	Test current: 6 A
Module width: 6 mm / 0.236 inch	
This test plug is not suitable for Ex e applications.	

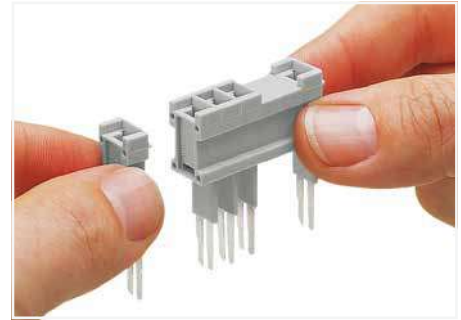

Snapping test plug and spacer modules together to assemble a multipole test plug module.

Test plug module; snaps together Module width: 5 mm		
Color	Item No.	Pack. Unit
○ gray	280-418	100 (25)

Test plug module; snaps together Module width: 6 mm		
Color	Item No.	Pack. Unit
○ gray	281-418	100 (25)

Spacer module; snaps together; bridges terminal blocks Module width: 5 mm		
Color	Item No.	Pack. Unit
○ gray	280-419	100 (25)

Spacer module; snaps together; bridges terminal blocks Module width: 6 mm		
Color	Item No.	Pack. Unit
○ gray	281-419	100 (25)

Accessories; for test plug modules

Test plug; with 500 mm cable; 2 mm Ø; max. 42 V		
Color	Item No.	Pack. Unit
red	210-136	50

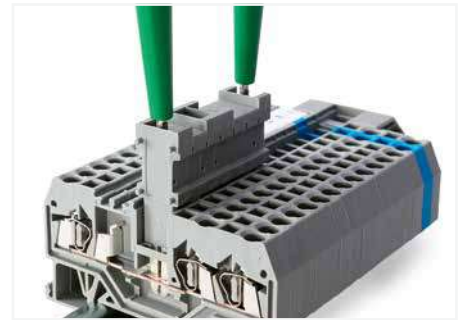

The test plug modules are directly plugged into the jumper contact slot of the current bar.

6

B-Type Test Plug Module for Testing 8 mm or 10 mm Wide Rail-Mount Terminal Blocks via Jumper Contact Slot in Current Bar 709 Series

Technical Data

0.2 ... 6 mm ²	24 ... 10 AWG
Test voltage: 800 V	Test current: 32 A
Module width: 8 mm / 0.315 inch	
This test plug is not suitable for Ex e applications.	



Technical Data

Module width: 2 mm / 0.079 inch
This intermediate plate is not suitable for Ex e applications.

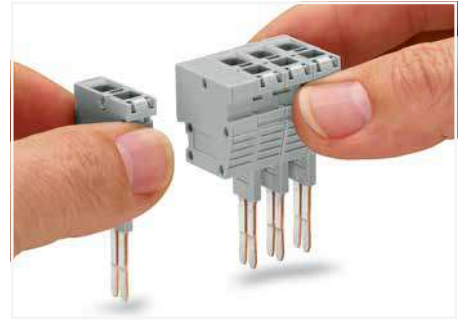

Snapping test plug and spacer modules together to assemble a multi-pole test plug module (max. 10 poles) for 8 mm terminal block width.

B-type test plug module; snaps together
Module width: 8 mm

Color	Item No.	Pack. Unit
○ gray	709-310	100 (25)

B-type spacer plate; snaps together; snaps on B-type test plug modules (709-310) and B-type spacer modules (709-311)
Module width: 2 mm

Color	Item No.	Pack. Unit
○ gray	709-312	100 (25)

B-type spacer module; snaps together; bridges commoned terminal blocks,
Module width: 8 mm

○ gray	709-311	100 (25)
--------	---------	----------

Accessories; item-specific

Strain relief plate; gray; for 8 mm wide terminal blocks

	2-pole	709-322	100 (25)
	4-pole	709-324	100 (25)
	6-pole	709-326	100 (25)

Accessories; item-specific

Strain relief plate; gray; for 10 mm wide terminal blocks

	2-pole	709-332	100 (25)
	4-pole	709-334	100 (25)
	6-pole	709-336	100 (25)

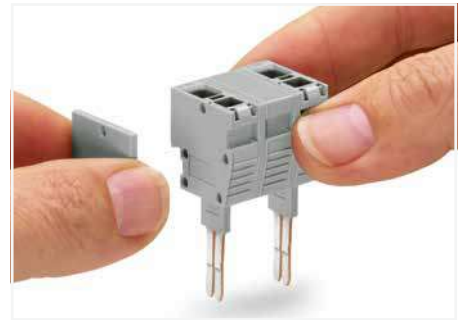

Snapping test plug and spacer modules (each with a spacer plate) together to assemble a multi-pole test plug module (max. 10 poles) for 10 mm terminal block width.

6



For testing individual circuits, offers a single-pole test plug accessory with CAGE CLAMP® up to 2.5 mm² (14 AWG) for direct contact with the current bar of a terminal block, or 1-pole test plug adapters for 4 mm Ø test plugs.

For serial testing on terminal block assemblies, has developed special multipole (max. 10-pole) modular test plug modules. WAGO's B-type test plug modules with CAGE CLAMP® connection are ideal for testing completely wired terminal blocks – even when using adjacent jumpers. For this testing type, the module assembly exactly matches the terminal block assembly. The test plug modules make direct contact to the jumper contact slots of the terminal blocks to be tested.

Power must be switched off when installing the test plug adapter. The safety guidelines for working on live installations must be observed.



The test plug modules are directly plugged into the jumper contact slot of the current bar (picture shows 284 Series).

Conductor Insulation Stop for Conductors 0.08 ... 1.5 mm² / 28 ... 16 AWG

Technical Data

Terminal block width: 4 mm / 0.157 inch



Technical Data

Terminal block width: 5 mm / 0.197 inch



Technical Data

Terminal block width: 6 mm / 0.236 inch

Insulation stop; 0.08 ... 0.2 mm² "s" (0.14 mm² "f-st"); 5 pcs/strip

Color	Item No.	Pack. Unit
○ white	279-470	200 (25)

Insulation stop; 0.08 ... 0.2 mm² "s" (0.14 mm² "f-st"); 5 pcs/strip

Color	Item No.	Pack. Unit
○ white	280-470	200 (25)

Insulation stop; 0.08 ... 0.2 mm² "s" (0.14 mm² "f-st"); 5 pcs/strip

Color	Item No.	Pack. Unit
○ white	281-470	200 (25)

Insulation stop; 0.25 mm²; 5 pcs/strip

● dark gray	279-471	200 (25)
-------------	---------	----------

Insulation stop; 0.25 ... 0.5 mm²; 5 pcs/strip

○ light gray	280-471	200 (25)
--------------	---------	----------

Insulation stop; 0.25 ... 0.5 mm²; 5 pcs/strip

○ light gray	281-471	200 (25)
--------------	---------	----------

Insulation stop; 0.75 ... 1 mm²; 5 pcs/strip

● dark gray	280-472	200 (25)
-------------	---------	----------

Insulation stop; 0.75 ... 1.5 mm²; 5 pcs/strip

● dark gray	281-472	200 (25)
-------------	---------	----------

6

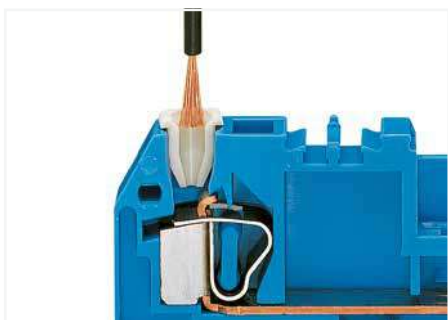

Insert stripped, untwisted conductor into insulation stop.



The problem: Wiring programmable logic controllers and microprocessor-operated control circuits often relies on very small, fine-stranded conductors. These conductors are highly flexible and deform when pushed against the conductor stop in terminal blocks. As a result, the conductor insulation – not the copper conductor – may be clamped, causing intermittent contact or no contact at all. Common to all terminal block types currently offered, this problem creates unnecessary downtime for troubleshooting.

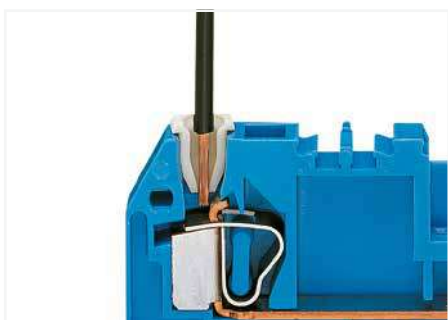

The conductor is bundled.

The solution: An insulation stop for rail-mount terminal blocks. Insulation stops automatically bundle the cores of fine-stranded conductors when inserted into the clamping unit, preventing splaying. This also limits the conductor entry to a defined cross sectional area – ensuring the actual conductor, not the insulation, will enter the clamping unit

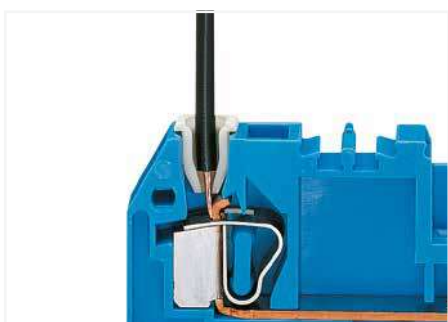

The conductor insulation is prevented from being pushed into the clamping unit by the positive stop.

Insulation stops are available as dividable 5-pole strips for 279, 280/780/870/880 and 281/781 Series Rail-Mount Terminal Blocks.

Insulation stop usage will not affect the conductor strip lengths for the aforementioned rail-mount terminal blocks.

Comb-Style Jumper Bar and Alternate Comb-Style Jumper Bar Operating Tool



Comb-style jumper bar; insulated; $I_N = I_N$ of terminal block; for 279 Series

	Item No.	Pack. Unit
○ 2-way	279-482	200 (25)
○ 3-way	279-483	200 (25)
○ 10-way	279-490	50 (25)

Comb-style jumper bar; insulated; $I_N = I_N$ of terminal block; for 280/769/780/880 Series

	Item No.	Pack. Unit
○ 2-way	280-482	200 (25)
○ 3-way	280-483	200 (25)
○ 10-way	280-490	50 (25)

Comb-style jumper bar; insulated; $I_N = I_N$ of terminal block; for 281/781 Series

	Item No.	Pack. Unit
○ 2-way	281-482	100 (25)
○ 3-way	281-483	100 (25)
○ 5-way	281-485	100 (25)
○ 10-way	281-490	50 (25)

Alternate comb-style jumper bar; insulated; $I_N = I_N$ of terminal block

○ 2-way	279-492	200 (25)
---------	---------	----------

Alternate comb-style jumper bar; insulated; $I_N = I_N$ of terminal block

○ 2-way	280-492	200 (25)
---------	---------	----------

Alternate comb-style jumper bar; insulated; $I_N = I_N$ of terminal block

○ 2-way	281-492	100 (25)
---------	---------	----------

Operating tool; insulated

2-way	279-432	1
3-way	279-433	1
10-way	279-440	1

Operating tool; insulated

2-way	280-432	1
3-way	280-433	1
10-way	280-440	1

Operating tool; insulated

2-way	280-432	1
3-way	280-433	1
5-way	281-440	1

6

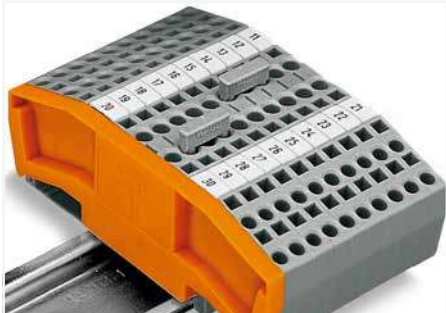

Commoning using comb-style jumper bars. Push comb-style jumper bars down until fully inserted.



4-conductor through terminal blocks, angled type – formation of groups with 3-way, comb-style jumper bars

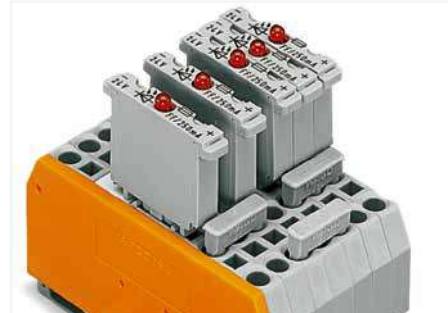

Carrier terminal blocks with component plugs, alternate comb-style jumper bars, 3-way, comb-style jumper bar

Staggered Jumper

Technical Data

400 V / 6 kV / 3



- ① Suitable for Ex e II applications
Rated voltage (max.): 275 V
23 A, for 2-conductor terminal blocks
22 A, for 3-conductor terminal blocks
20 A, for 4-conductor terminal blocks
(see Section 15)
- ② Suitable for Ex e II applications
Rated voltage (max.): 275 V; 26 A
(see Section 15)

Staggered jumper; insulated; 5 mm wide; I_n 24 A

	Item No.	Pack. Unit
<input type="radio"/> 1 to 2	780-452 ①	100 (25)
<input type="radio"/> 1 to 3	780-453 ①	100 (25)
<input type="radio"/> 1 to 4	780-454 ①	100 (25)
<input type="radio"/> 1 to 5	780-455 ①	50 (25)
<input type="radio"/> 1 to 6	780-456 ①	50 (25)
<input type="radio"/> 1 to 7	780-457 ①	50 (25)
<input type="radio"/> 1 to 8	780-458 ①	50 (25)

Staggered jumper; insulated; 6 mm wide; I_n 32 A

<input type="radio"/> 1 to 2	781-452 ②	100 (25)
<input type="radio"/> 1 to 3	781-453 ②	100 (25)
<input type="radio"/> 1 to 4	781-454 ②	100 (25)
<input type="radio"/> 1 to 5	781-455 ②	50 (25)
<input type="radio"/> 1 to 6	781-456 ②	50 (25)

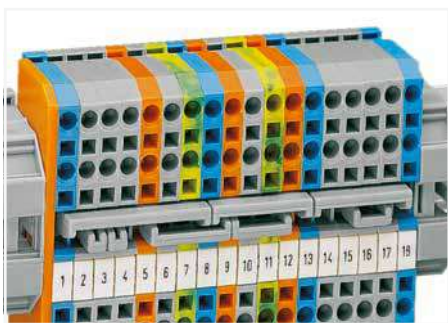

Staggered jumpers for sophisticated circuit requirements
– push jumpers down until fully inserted.

Push-In Type Wire Jumper

Technical Data

800 V / 8 kV / 3

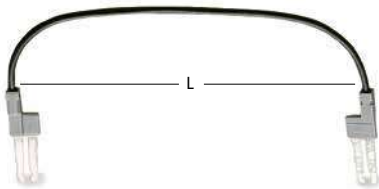
I_N 9 A

Push-in type wire jumper; insulated; 0.75 mm² conductor cross section

	Item No.	Pack. Unit
L = 60 mm	249-125	10

Push-in type wire jumper; insulated; 0.75 mm² conductor cross section

L = 110 mm	249-126	10
------------	---------	----

Push-in type wire jumper; insulated; 0.75 mm² conductor cross section

L = 250 mm	249-127	10
------------	---------	----

Terminal Blocks Series	Wire Jumpers Item No.	"n"
279 (1.5 mm ² /16 AWG)	249-125	13
	249-126	25
	249-127	60
280, 775, 780 (2.5 mm ² /14 AWG) 769, 880 (4 mm ² /12 AWG)	249-125	10
	249-126	20
	249-127	48
281, 781, 776, 777 (4 mm ² /12 AWG)	249-125	9
	249-126	17
	249-127	40

"n" = number of 279, 280/769/780/880 and 281/781 Series Rail-Mount Terminal Blocks that can be skipped with a wire jumper.

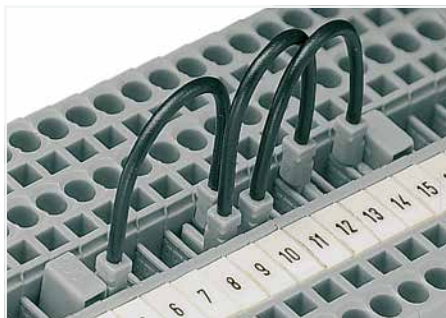

The 280/775/780 and 281/776/777/781 Series Terminal Blocks accept two wire jumpers, allowing the use of commoning chains. Furthermore, the 280/769/775/780/880 and 281/776/777/781 Series allow both wire jumper and adjacent jumper to be simultaneously plugged into a same terminal block.

Push-in type wire jumper:

When installing machines or control systems, it is often necessary to make an additional connection between two terminal blocks that are not next to each other on the rail. In such cases, WAGO's touch-proof, push-in type wire jumpers are the ideal solution.





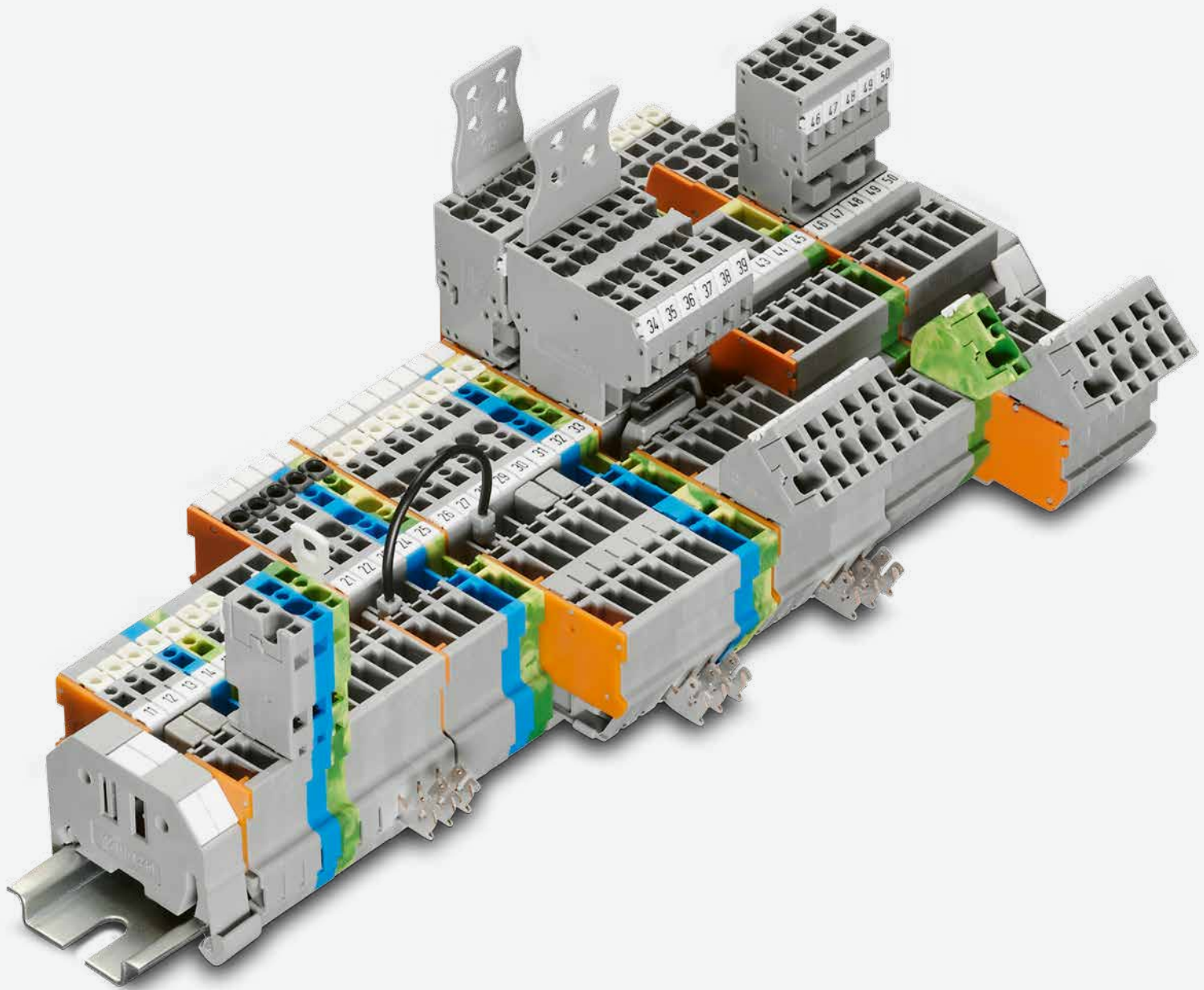



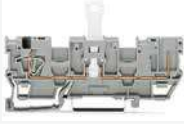

This jumper is compatible with the following rail-mount terminal blocks:

- 279 Series (1.5 mm²/16 AWG),
 - 280/775/780 Series (2.5 mm²/14 AWG)
 - 281/769/776/777/781 and 880 Series (4 mm²/12 AWG)
- They are available in three conductor lengths (60, 110 and 250 mm), allowing up to 60 terminal blocks to be commoned depending on their width (see table on the right).

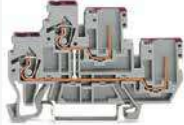

WAGO Rail-Mount Terminal Blocks with a Pluggable Connector X-COM[®]-SYSTEM

WAGO Rail-Mount Terminal Blocks with a Pluggable Connector X-COM®-SYSTEM

			Page
	Carrier Terminal Blocks 0.08 ... 4 mm ² (28 ... 12 AWG)	769 Series	436
	Carrier Terminal Blocks; with Three Jumper Positions 0.08 ... 4 mm ² (28 ... 12 AWG)	769 Series	446
	Disconnect Carrier Terminal Blocks; with Two Jumper Positions 0.08 ... 4 mm ² (28 ... 12 AWG)	769 Series	438
	Diode and LED Carrier Terminal Blocks 0.08 ... 4 mm ² (28 ... 12 AWG)	769 Series	440
	Carrier Terminal Blocks for a Pluggable Module 0.08 ... 4 mm ² (28 ... 12 AWG)	769 Series	458
	Double-Deck Carrier Terminal Blocks 0.08 ... 2.5 (4 "f-st") mm ² (28 ... 12 AWG)	870 Series	466
	Male Connectors; with CAGE CLAMP® Connection 0.08 ... 4 mm ² (28 ... 12 AWG)	769 Series	476
	Male Headers; with Solder Pins 0.08 ... 4 mm ² (28 ... 12 AWG)	769 Series	480
	Female Plugs; with/without Lateral Locking Levers 0.08 ... 4 mm ² (28 ... 12 AWG)	769 Series	486
	Female Plugs for Self-Assembly 0.08 ... 4 mm ² (28 ... 12 AWG)	769 Series	490
	Pre-Assembled Female Plugs 0.08 ... 4 mm ² (28 ... 12 AWG)	769 Series	492
	Strain Relief Housings	769 Series	494

COM-bining Connectors and Rail-Mount Terminal Blocks X-COM®-SYSTEM

The X-COM-SYSTEM® is the perfect solution for switchgear and control applications.

X-COM® is designed for a **rated current up to 16/32 A at U_N 500 V and 4 mm² (12 AWG) rated cross section (up to 600 V, 10 A, and 12 AWG UL)**. This offers an alternative to heavy-duty rectangular and circular connectors used in power wiring applications where electrical compliance is more important than a high degree of protection.

X-COM® conveniently enables the use of pre-assembled connector systems and offers the following advantages:

- During manufacturing: Pre-wired subassemblies can be tested before installation.
- During assembly: Pre-assembled pluggable cable harnesses help solve time and space issues on site. Connector systems with protection against mismatching can be handled by installers of all skill levels.
- During maintenance: Subassemblies can be replaced quickly and without errors.

The X-COM®-SYSTEM consists of rail-mount carrier terminal blocks, male connectors and female plugs with different mounting systems, as well as male headers with solder pins. Pin spacing is generally 5 mm (0.197 inch).

Protection Against Mismatching and Accidental Contact

The WAGO-X-COM®-SYSTEM is **fully protected against accidental contact – even when plugs are disconnected**. This dramatically simplifies the planning of power distribution.

Furthermore, the whole system is **100% protected against mismatching**. Its coding, without the loss of any poles, prevents mismatching of male connectors and female plugs having the same number of poles.

Carrier Terminal Blocks

Carrier terminal blocks are available as through terminal blocks, double-deck terminal blocks and ground conductor terminal blocks with automatic contact to the DIN-rail. Carrier terminal blocks with specialty functions are available in disconnect, diode and LED versions. Carrier terminal blocks equipped with an additional socket can accommodate a wide range of pluggable electronic modules (e.g., relays, optocouplers, signal conditioners).

Depending on the type of terminal block, the carrier terminal blocks are equipped with one to three jumper positions for commoning signals via insulated push-in type jumpers.

Applications

X-COM®-SYSTEM connects to:

- Frequency converters
- Thyristor actuators
- Soft start motor controllers
- Motors
- Phase filters
- Power subassemblies
- Power supply units
- Uninterruptible power supply (UPS)
- "Panel-to-door" wiring
- Pluggable high-current, feed-through connections
- Flying leads

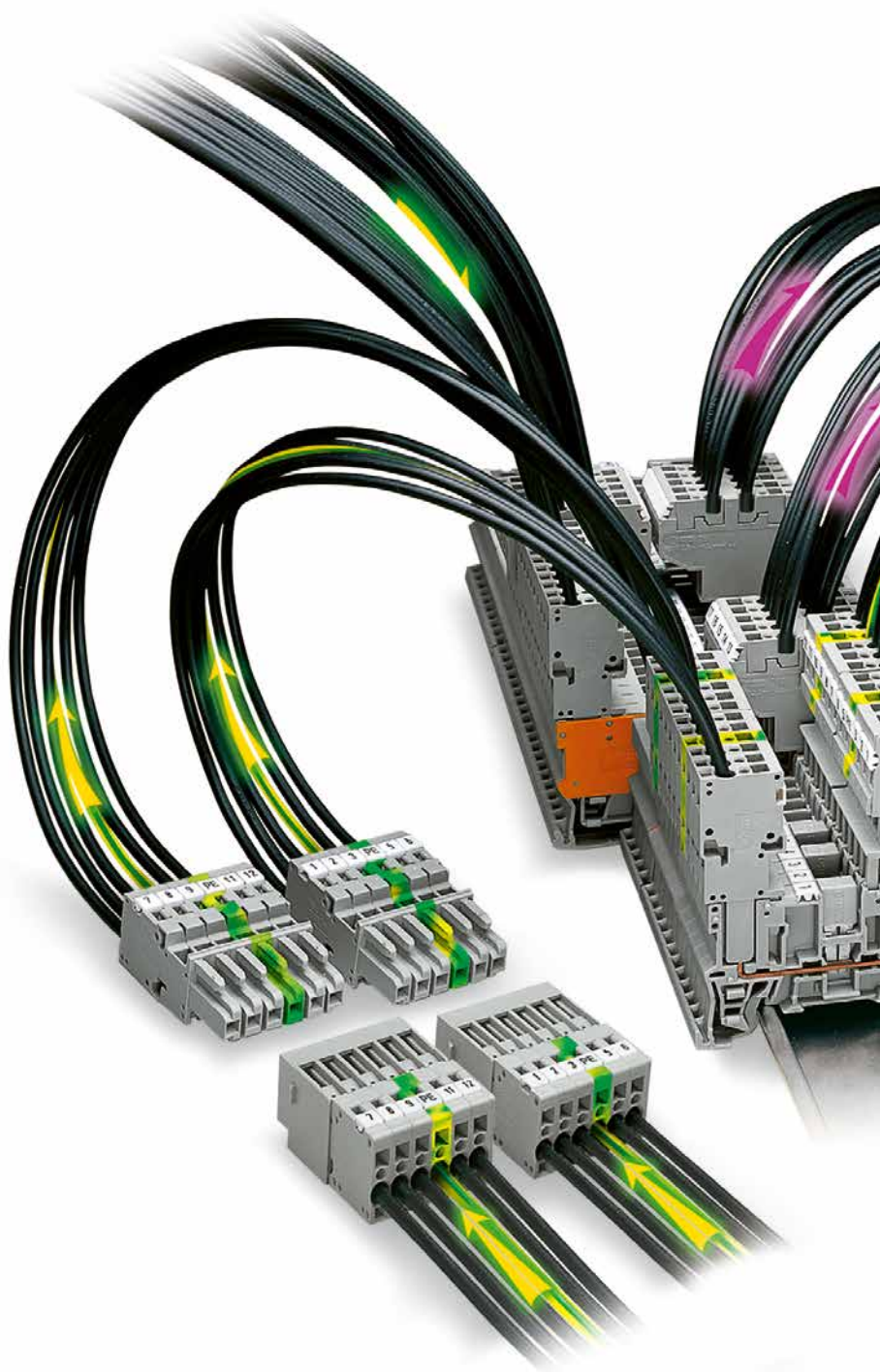

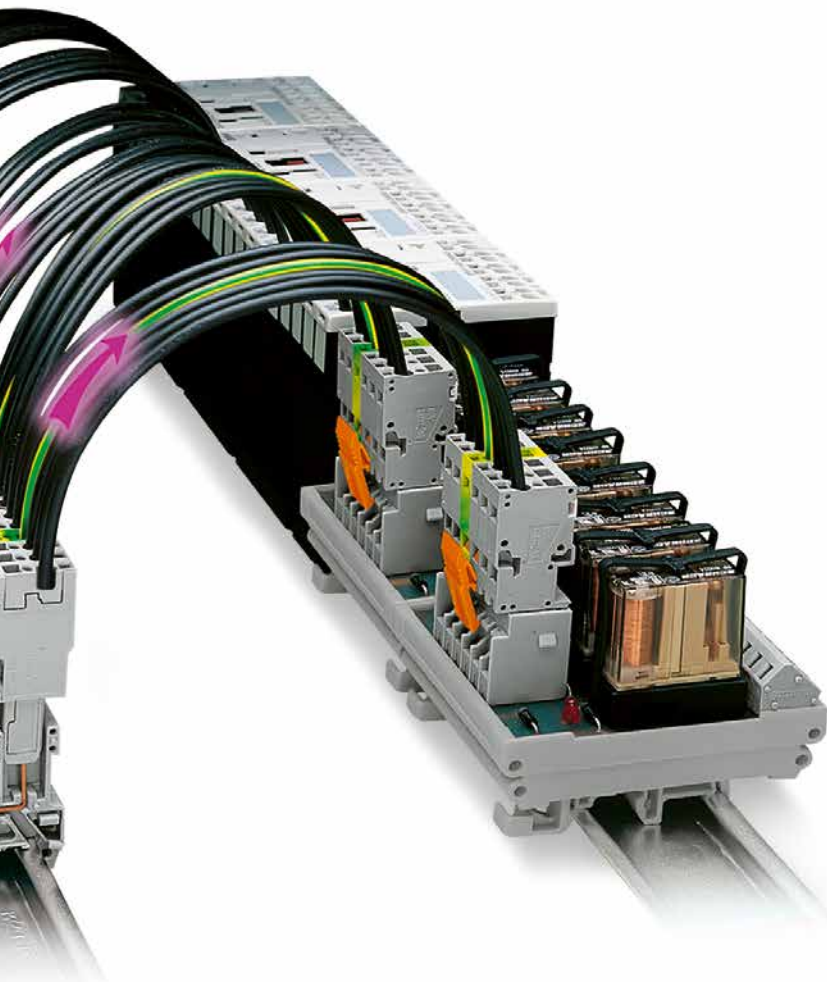

Female Plugs

The mating half of the carrier terminal blocks consists of modular female plugs (1- to 15-pole, 1-/2-conductor, straight/angled). Angled female plugs combined with double-deck terminal blocks offer high-density wiring and reduce overall terminal block height. A jumper slot simplifies potential distribution.

This makes commoning supply lines particularly easy as the power supply of downstream subassemblies is maintained even after female plugs have been removed.

1-Pole Female Plugs

Special 1-pole female plugs can carry the full rated current of the terminal blocks for many applications:

- as test plug adapters
- as connectors for motor lead tests
- for all types of patchboard applications
- for the creation of multipole prototypes
- for phase selection of 230 V loads in a three-phase network without interfering with the wiring
- for single-pole power supply in commercial or recreational vehicles. The grounding of all electrical components is connected through the chassis.

Male Connectors

Male connectors are available with snap-in mounting feet for panel mounting, with mounting flanges for feedthrough applications or without mounting elements for flying leads. Strain relief plates are available as accessories.

Subassemblies on printed circuit boards can be integrated into the system wiring using male headers with solder pins. As a result, parts can be exchanged quickly without wiring errors.

Degree of Protection

Mated: IP20

Unmated: IP20

Temperature range:

-35 ... +100 °C

Carrier Terminal Blocks and Female Plugs X-COM®-SYSTEM

769 Series

Description and Installation

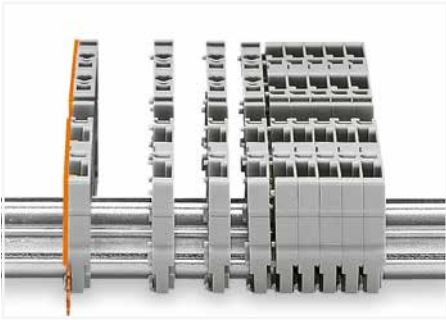

Snap individual carrier terminal blocks onto the DIN-rail and slide together.



Open the assembly by laterally sliding a block via operating tool and remove terminal block via release lever.

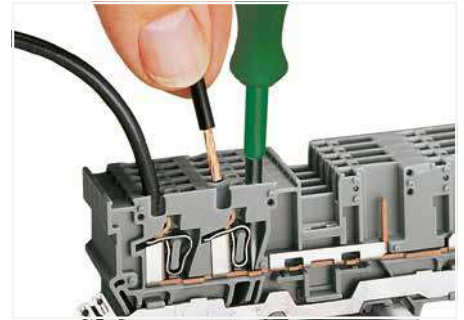

Carrier terminal block: Insert/remove conductor via operating tool (3.5 x 0.5 mm blade).



Coding a female plug by removing coding finger(s) via cutting tool. Do not remove the first and last coding fingers or use an additional locking lever.

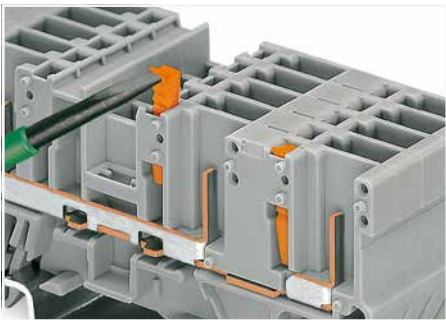

Snap coding pin in proper direction on carrier terminal block.
Shown: Coding pin removal from carrier terminal block.

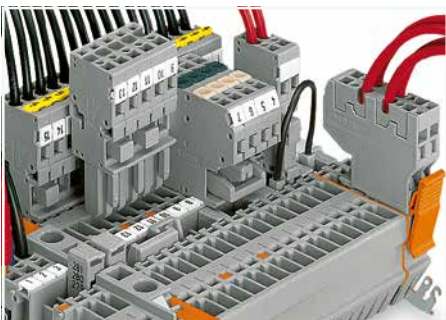
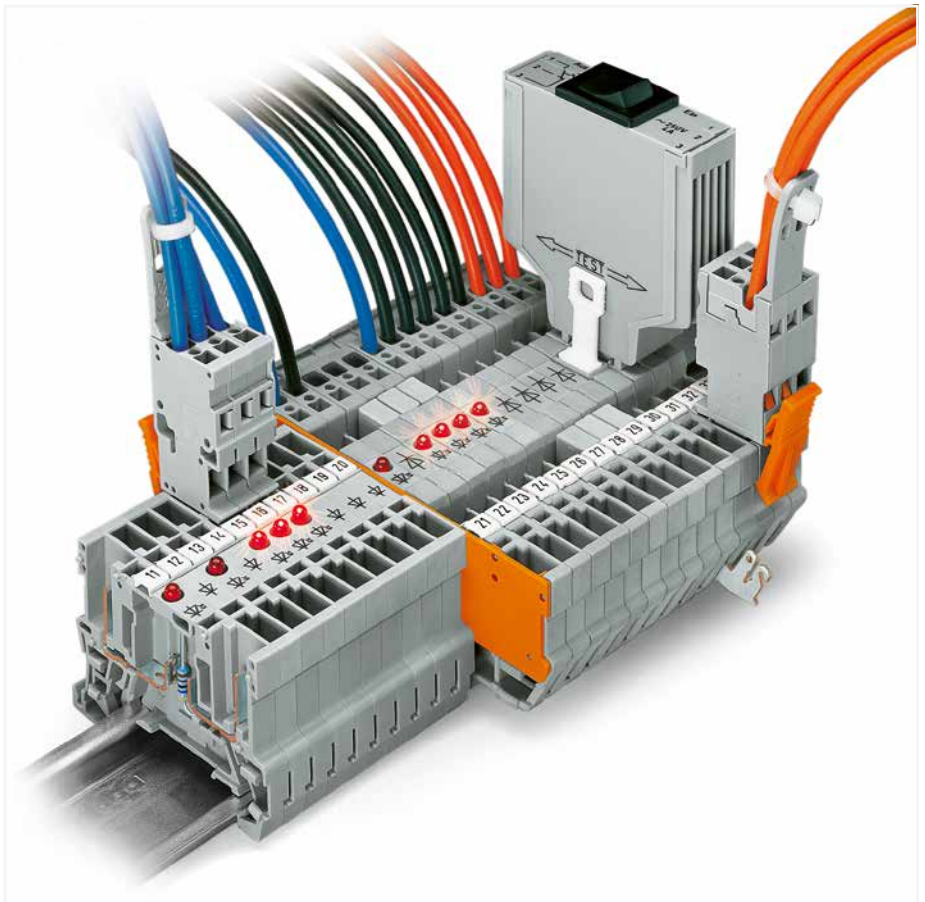

Commoning with adjacent or staggered jumpers – push jumpers down until fully inserted.



Commoning carrier terminal blocks via staggered jumpers.

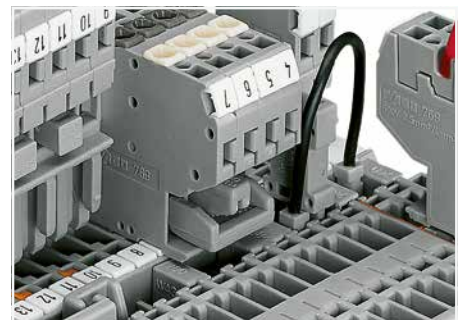

Commoning a 2-conductor female plug via staggered jumper and carrier terminal blocks via adjacent jumpers.



CAGE CLAMP® terminates the following copper conductors:
solid "s"



stranded "st"



fine-stranded "f-st", also with tinned single strands

With ferruled conductors, it is necessary to use a terminal block one size smaller than the conductor's nominal cross section.

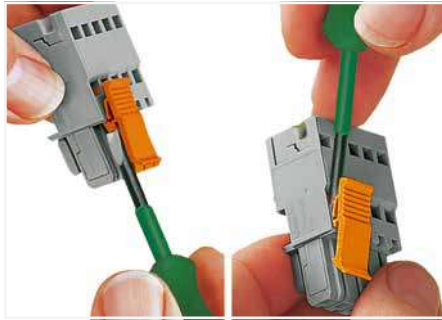
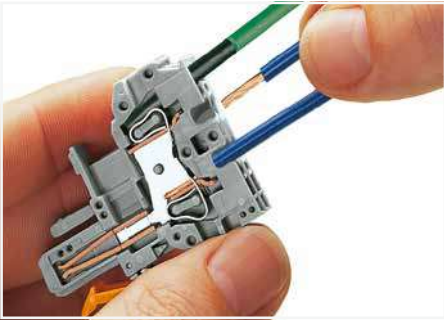

CAGE CLAMP® connection
 Female plug: Inserting/removing a conductor via operating tool.
 Operation 90° to conductor is also possible.
 With ferruled conductors, it is necessary to use a terminal block one size smaller than the conductor's nominal cross section.

Locking/releasing a lever.

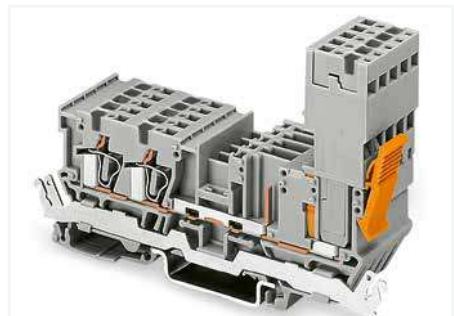
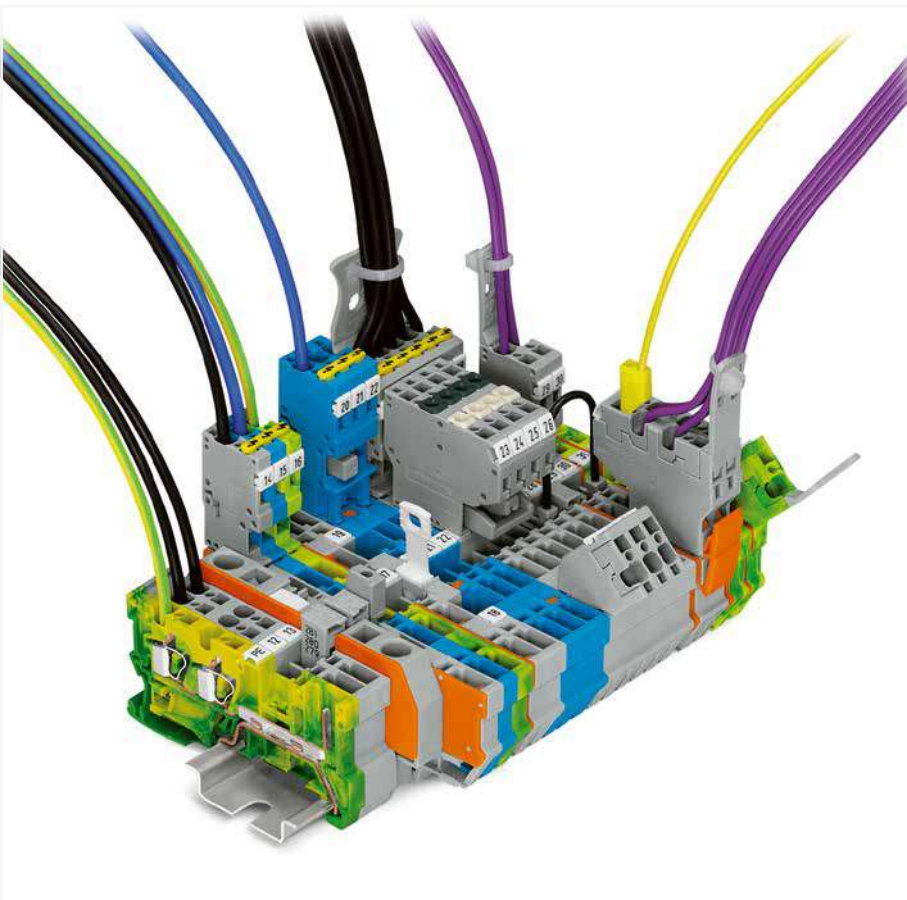

Female plug secured with locking lever on the terminal block side.

7



Removing a female plug via conductor bundle provided with strain relief plate.

Note: Female plugs used according to the regulations must not be connected/disconnected when live or under load.

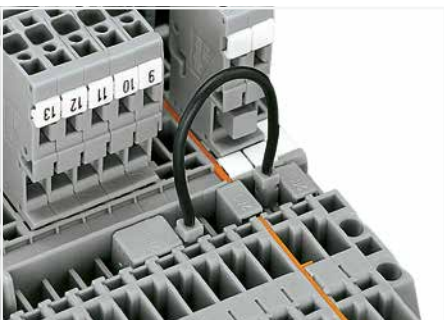

Commoning carrier terminal blocks via push-in type wire jumpers or adjacent jumpers – even over an intermediate plate.

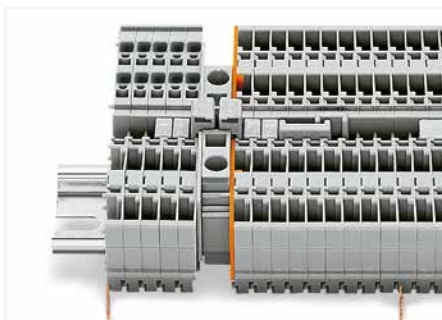

Commoning "supply terminal blocks" (up to 10 mm²/8 AWG) with carrier terminal blocks via step-down jumpers.



Commoning a 1-conductor female plug via miniature adjacent jumpers.



fine-stranded, tip-bonded



fine-stranded, with ferrule (gastight crimped)



fine-stranded, with pin terminal (gastight crimped)

Carrier Terminal Blocks, Female Plugs and Male Connectors X-COM®-SYSTEM

769 Series

Product Range Overview



1-conductor/1-pin carrier terminal block
1-conductor female plug; straight*
*1-conductor angled female plug is also possible!

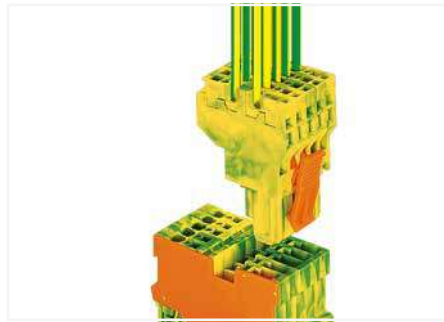

1-conductor/1-pin ground carrier terminal block
2-conductor female plug; green-yellow

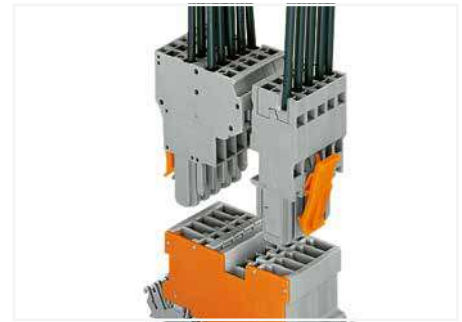

2-pin carrier terminal block; with shield contact
2-conductor female plug
1-conductor female plug; straight*
*1-conductor angled female plug is also possible!

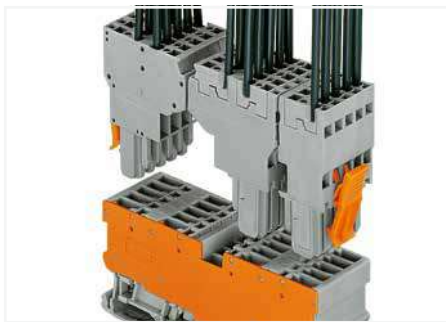

4-pin carrier terminal block
2-conductor female plug
1-conductor female plug; straight

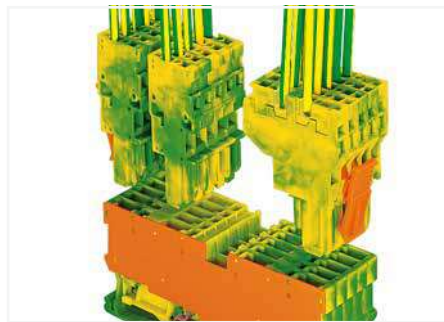

4-pin ground carrier terminal block
1-conductor female plug; straight
2-conductor female plug

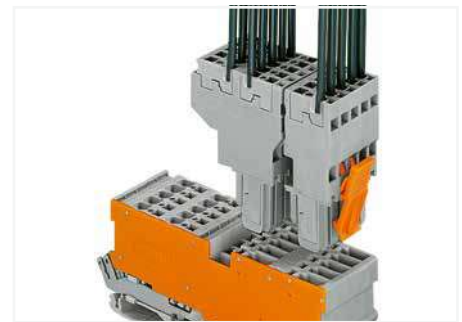

2-conductor/2-pin carrier terminal block; with shield contact
2-conductor female plug
1-conductor female plug; straight



1-conductor/1-pin disconnect carrier terminal block
1-conductor female plug; straight*
*1-conductor angled female plug is also possible!



2-pin diode carrier block
1-conductor female plug; straight*
*1-conductor angled female plug is also possible!



2-pin LED carrier block
1-conductor female plug; straight*
*1-conductor angled female plug is also possible!

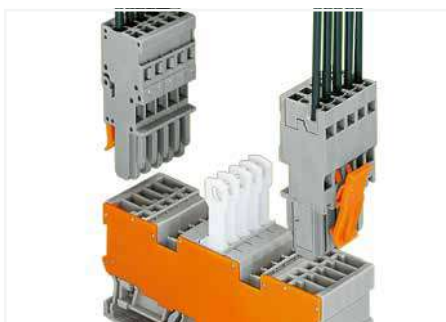

2-pin disconnect carrier terminal block; with two jumper positions
1-conductor female plug; straight*
*1-conductor angled female plug is also possible!

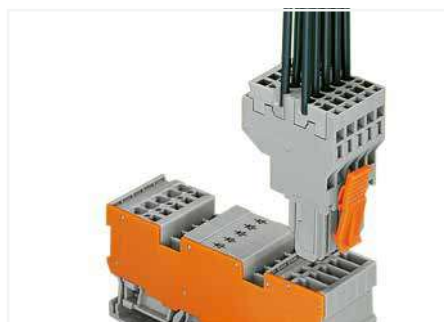

1-conductor/1-pin diode carrier terminal block; with two jumper positions
2-conductor female plug

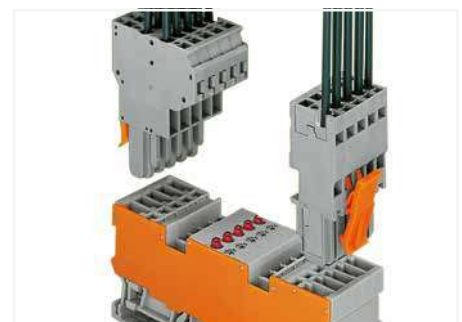

2-pin LED carrier terminal block; with two jumper positions
2-conductor female plug
1-conductor female plug; straight



1-conductor/1-pin carrier terminal block; with three jumper positions
1-conductor female plug; straight*
*1-conductor angled female plug is also possible!



Male connector; with CAGE CLAMP® connection
1-conductor female plug; straight

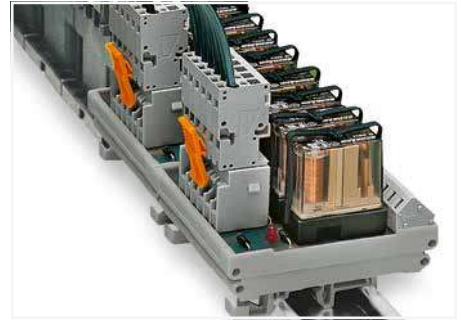

Male header; with straight solder pins and 1-conductor female plug (picture shows a relay module)

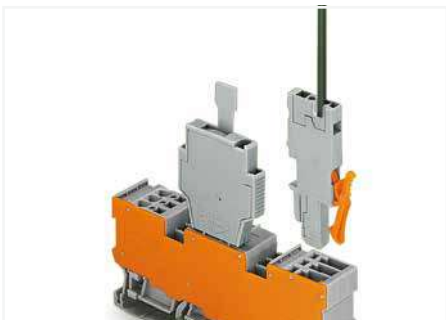

1-conductor/1-pin carrier terminal block; with two jumper positions
1-conductor female plug; straight*
Fuse plug; 6 mm wide (every other terminal block)
*1-conductor angled female plug is also possible!



Male connector; with CAGE CLAMP® connection and snap-in mounting feet
1-conductor female plug; straight

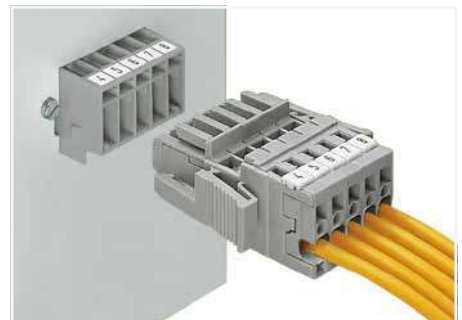

Male header and 1-conductor female plug; with lateral locking levers



2-pin terminal block for pluggable modules; with two jumper positions and separator plate
1-conductor female plug; straight*
Relay plug; 25 mm wide
*1-conductor angled female plug is also possible!

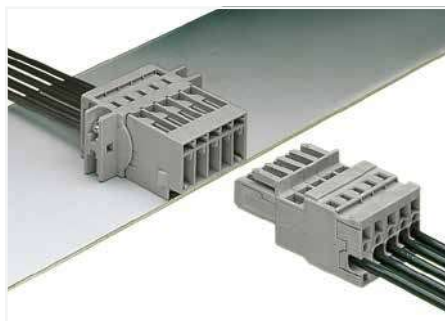

Male connector; with CAGE CLAMP® and mounting flanges
1-conductor female plug; straight

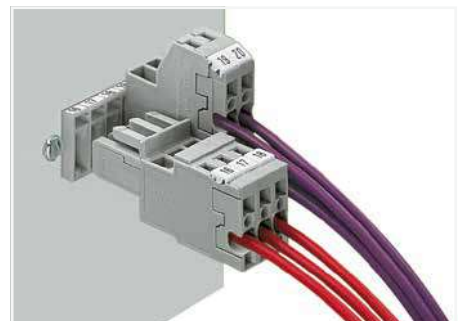

Male header; with feedthrough flanges
1-conductor female plug
2-conductor female plug



1-conductor/1-pin double-deck carrier terminal block
1-conductor female plug; angled*
*1-conductor straight female plug is also possible!

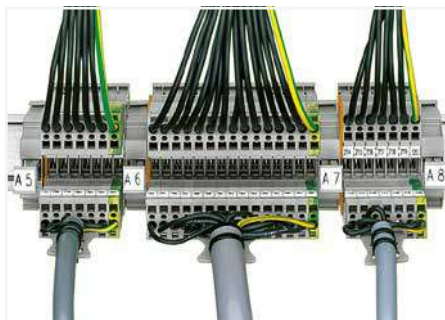

Cable entry into the control cabinet:
The cables are led into the control cabinet with the connected female plugs and are directly plugged onto the carrier terminal blocks.





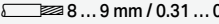

Cable entry in the base of the control cabinet
Separate strain relief, movable IP54 bottom plates sealed with sponge rubber (e.g., by Rittal)

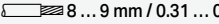
1-Conductor/1-Pin Carrier Terminal Block X-COM®-SYSTEM 4 mm²; 769 Series

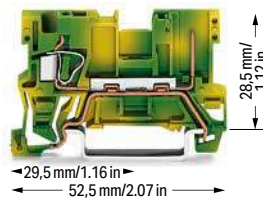
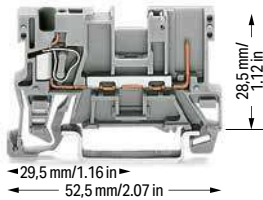
Technical Data	
0.08 ... 4 mm ²	28 ... 12 AWG
500 V / 6 kV / 3 ①	300 V, 20 A ②
I _N 32 A ②	300 V, 20 A ③
Terminal block width: 5 mm / 0.197 inch	
 8 ... 9 mm / 0.31 ... 0.35 inch	

Technical Data	
0.08 ... 4 mm ²	28 ... 12 AWG
Terminal block width: 5 mm / 0.197 inch	
 8 ... 9 mm / 0.31 ... 0.35 inch	





1-conductor/1-pin carrier terminal block		
Color	Item No.	Pack. Unit
 gray	769-176	100
 blue	769-176/000-006	100
 orange	769-176/000-012	100

1-conductor/1-pin ground carrier terminal block		
Color	Item No.	Pack. Unit
 green-yellow	769-237	100

1-conductor/1-pin carrier terminal block; with shield contact		
Color	Item No.	Pack. Unit
 gray	769-231 ①	50

Accessories; item-specific			
Protective warning marker; with black high-voltage symbol; for 5 terminal blocks			
	yellow	280-415	100 (25)

Accessories; 769 Series
Appropriate marking systems: Mini-WSB/Mini-WSB Inline

End and intermediate plate; 1.1 mm thick			
	orange	769-308	100 (25)
	gray	769-307	100 (25)

Staggered jumper; insulated; 5 mm wide; I _N 24 A			
	1 to 2	780-452	100 (25)
	1 to 3	780-453	100 (25)
	1 to 4	780-454	100 (25)
	1 to 5	780-455	50 (25)
	1 to 6	780-456	50 (25)
	1 to 7	780-457	50 (25)
	1 to 8	780-458	50 (25)

Insulation stop; 0.08 ... 0.2 mm ² "s" (0.14 mm ² "f-st"); 5 pcs/strip			
	white	769-470	200 (25)

Push-in type wire jumper; insulated; 0.75 mm ² conductor cross section; I _N 9 A			
	L = 60 mm	249-125	100 (10)
	L = 110 mm	249-126	100 (10)
	L = 250 mm	249-127	100 (10)

Insulation stop; 0.25 ... 0.5 mm ² ; 5 pcs/strip			
	light gray	769-471	200 (25)

Test plug module; snaps together; 5 mm wide			
	gray	280-418	100 (25)

Insulation stop; 0.75 ... 1 mm ² ; 5 pcs/strip			
	dark gray	769-472	200 (25)

Spacer module; snaps together; 5 mm wide			
	gray	280-419	100 (25)

Coding pin; for coding female plugs			
	orange	769-435	100 (25)

Adjacent jumper; insulated; I _N = I _N terminal block			
	gray	280-402	200 (25)

Test plug; with 500 mm cable; 2 mm Ø; max. 42 V			
	red	210-136	50

Alternate jumper; insulated; I _N = I _N terminal block			
	gray	280-409	100 (25)

① 500 V = rated voltage
6 kV = rated impulse voltage
3 = pollution degree
250 V / 4 kV / 3 = Nominal voltage with shield contact (see Section 15)

② See current-carrying capacity curve on page 454 and upon request

Please observe the application notes:
Insulation stop, page 425
Jumpers, from page 426
Testing accessories, from page 421
Mini-WSB marking system, page 684

Approvals and corresponding ratings, visit www.wago.com

Accessories; 769 Series
Appropriate marking systems:
Mini-WSB/Mini-WSB Inline

Test plug adapter; 5 mm wide; for 1.5 ... 4 mm² terminal blocks

	gray	280-404	100 (25)
---	------	---------	----------

Pin cover; with Mini-WSB marker slot			
	gray	769-438	100 (25)
	orange	769-439	100 (25)

1-connector female plug; straight			
	gray	769-101	200

1-conductor female plug; angled			
	gray	769-101/022-000	200

2-conductor female plug			
	gray	769-121	100

Mini-WSB Inline, plain; 1,700 WMB markers (5 mm)/reel; 5 ... 5.2 mm stretchable			
	white	2009-145	1

Mini-WSB marking card; white; 10 strips with 10 markers/card; 5 mm wide markers			
	plain	248-501	5

1-Conductor/1-Pin Carrier Terminal Blocks and 1-/2-Conductor Female Plugs X-COM®-SYSTEM Assembly Types



1-conductor female plug
Carrier terminal blocks can be commoned via 280 and 780 Series Jumpers and tested using a test plug adapter (280-4..).

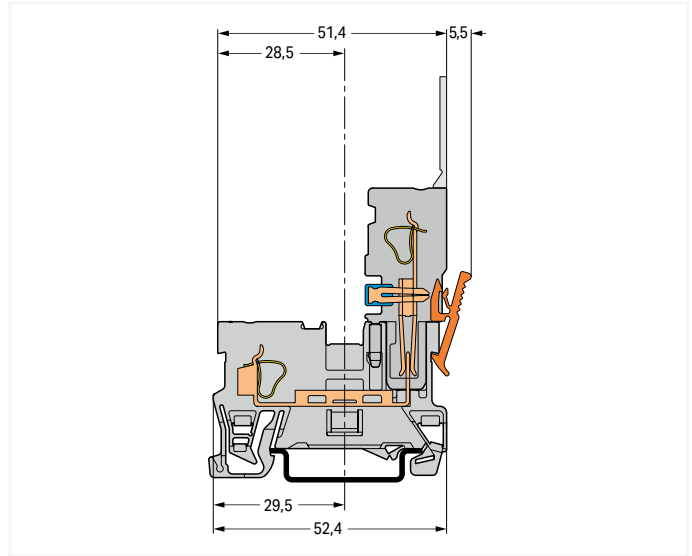

Carrier terminal block



2-conductor female plug
Carrier terminal blocks can only be commoned via 280 Series Adjacent and Alternate Jumpers.

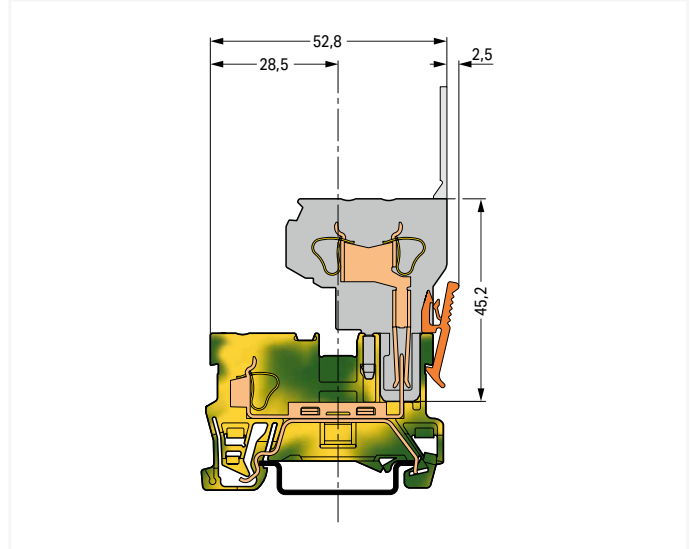

Ground carrier terminal block

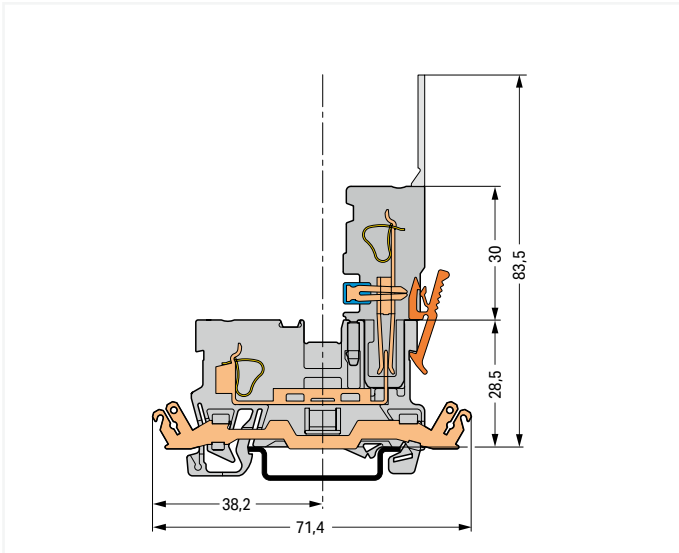

Carrier terminal block; with shield contact

2-Pin Carrier Terminal Block X-COM®-SYSTEM 769 Series

Technical Data

500 V / 6 kV / 3 ①

300 V, 20 A ②

 I_N 32 A ②

300 V, 20 A ②

Terminal block width: 5 mm / 0.197 inch

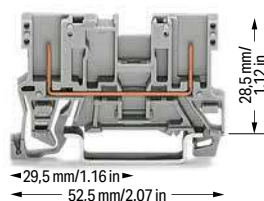

2-Pin Carrier Terminal Block

Color	Item No.	Pack. Unit
gray	769-156	100
blue	769-156/000-006	100

2-pin carrier terminal block; with shield contact

gray	769-221 ①	50
------	-----------	----

Technical Data

Terminal block width: 5 mm / 0.197 inch

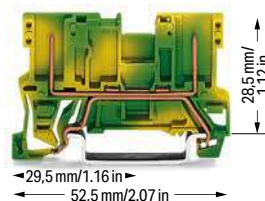

2-pin ground carrier terminal block

Color	Item No.	Pack. Unit
green-yellow	769-227	100

① 500 V = rated voltage
6 kV = rated impulse voltage
3 = pollution degree
250 V / 4 kV / 3 = Nominal voltage with shield contact (see Section 15)

② See current-carrying capacity curve and upon request

Please observe the application notes:
Jumpers, from page 426
Testing accessories, from page 421
Mini-WSB marking system, page 684

Approvals and corresponding ratings, visit www.wago.com

Accessories; 769 Series

Appropriate marking systems: Mini-WSB/Mini-WSB Inline

End and intermediate plate; 1.1 mm thick

orange	769-306	100 (25)
gray	769-305	100 (25)

Coding pin; for coding female plugs

orange	769-435	100 (25)
--------	---------	----------

Adjacent jumper; insulated; $I_N = I_N$ terminal block

gray	280-402	200 (25)
------	---------	----------

Alternate jumper; insulated; $I_N = I_N$ terminal block

gray	280-409	100 (25)
------	---------	----------

Staggered jumper; insulated; 5 mm wide; I_N 24 A

1 to 2	780-452	100 (25)
1 to 3	780-453	100 (25)
1 to 4	780-454	100 (25)
1 to 5	780-455	50 (25)
1 to 6	780-456	50 (25)
1 to 7	780-457	50 (25)
1 to 8	780-458	50 (25)

Push-in type wire jumper; insulated; 0.75 mm² conductor cross section; I_N 9 A

L = 60 mm	249-125	100 (10)
L = 110 mm	249-126	100 (10)
L = 250 mm	249-127	100 (10)

Test plug module; snaps together; 5 mm wide

gray	280-418	100 (25)
------	---------	----------

Spacer module; snaps together; 5 mm wide

gray	280-419	100 (25)
------	---------	----------

Test plug adapter; 5 mm wide; for 1.5 ... 4 mm² terminal blocks

gray	280-404	100 (25)
------	---------	----------

Pin cover; with Mini-WSB marker slot

gray	769-438	100 (25)
orange	769-439	100 (25)

1-conductor female plug; straight

gray	769-101	200
------	---------	-----

1-conductor female plug; angled

gray	769-101/022-000	200
------	-----------------	-----

2-conductor female plug

gray	769-121	100
------	---------	-----

Mini-WSB Inline, plain; 1,700 WMB markers (5 mm)/reel; 5 ... 5.2 mm stretchable

white	2009-145	1
-------	----------	---

Mini-WSB marking card; white; 10 strips with 10 markers/card; 5 mm wide markers

plain	248-501	5
-------	---------	---

7

2-Pin Carrier Terminal Blocks and 1-/2-Conductor Female Plugs X-COM®-SYSTEM Assembly Types



1-Conductor Female Plugs
Carrier terminal blocks can be commoned via 280 and 780 Series Jumpers and tested using a test plug adapter (280-4..).

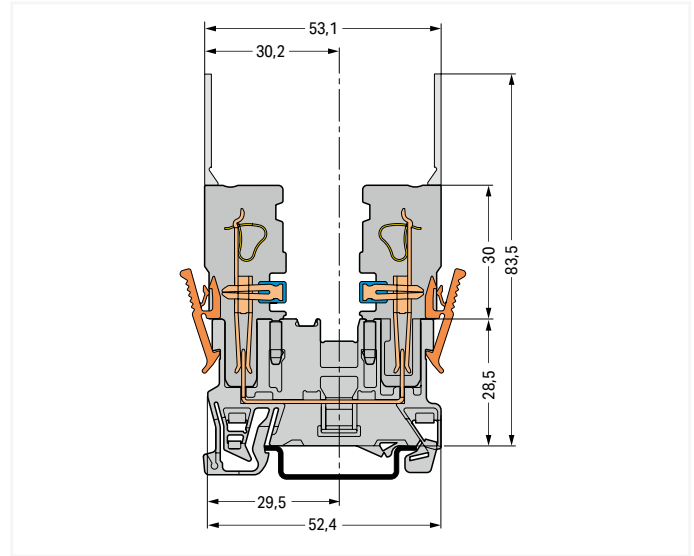

Carrier terminal block



1- and 2-Conductor Female Plug
Carrier terminal blocks can only be commoned via 280 Series Adjacent and Alternate Jumpers.

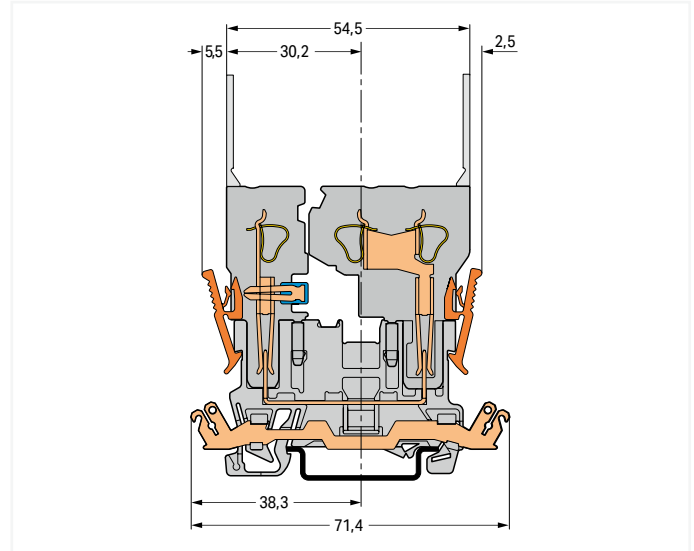

Carrier terminal block; with shield contact



2- and 1-Conductor Female Plug
Carrier terminal blocks can be commoned via 280 and 780 Series Jumpers.

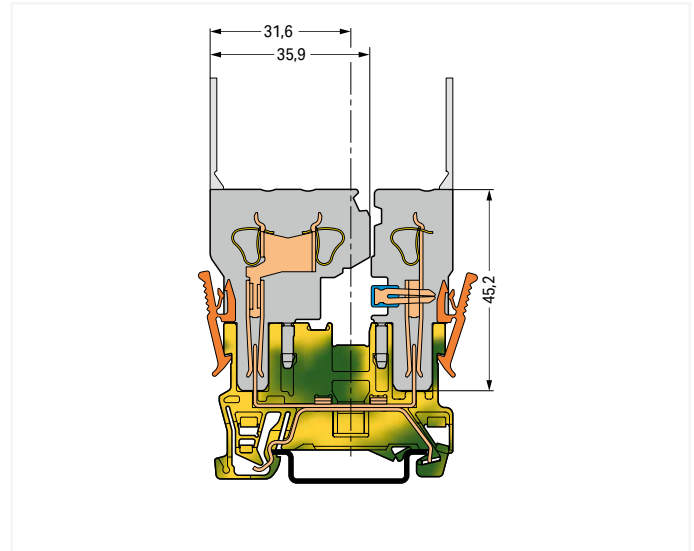

Ground carrier terminal block

2-Conductor/2-Pin Carrier Terminal Block X-COM®-SYSTEM 4 mm²; 769 Series

Technical Data

0.08 ... 4 mm ²	28 ... 12 AWG
500 V / 6 kV / 3 ①	300 V, 20 A ②
I _N 32 A ②	300 V, 20 A ③

Terminal block width: 5 mm / 0.197 inch

8 ... 9 mm / 0.31 ... 0.35 inch

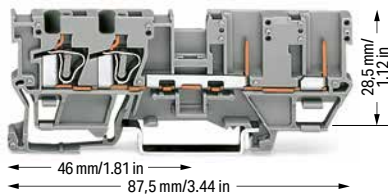

2-conductor/2-pin carrier terminal block

Color	Item No.	Pack. Unit
gray	769-171	50
blue	769-171/000-006	50

2-conductor/2-pin carrier terminal block; with shield contact

gray	769-211 ①	50
------	-----------	----

Accessories; item-specific

Protective warning marker; with black high-voltage symbol; for 5 terminal blocks

yellow	280-415	100 (25)
--------	---------	----------

Accessories; 769 Series

Appropriate marking systems: Mini-WSB/Mini-WSB Inline

End and intermediate plate; 1.1 mm thick

orange	769-304	100 (25)
gray	769-303	100 (25)

Insulation stop; 0.08 ... 0.2 mm² "s" (0.14 mm² "f-st"); 5 pcs/strip

white	769-470	200 (25)
-------	---------	----------

Insulation stop; 0.25 ... 0.5 mm²; 5 pcs/strip

light gray	769-471	200 (25)
------------	---------	----------

Insulation stop; 0.75 ... 1 mm²; 5 pcs/strip

dark gray	769-472	200 (25)
-----------	---------	----------

Coding pin; for coding female plugs

orange	769-435	100 (25)
--------	---------	----------

Adjacent jumper; insulated; I_N = I_N terminal block

gray	280-402	200 (25)
------	---------	----------

Alternate jumper; insulated; I_N = I_N terminal block

gray	280-409	100 (25)
------	---------	----------

Technical Data

0.08 ... 4 mm ²	28 ... 12 AWG
----------------------------	---------------

Terminal block width: 5 mm / 0.197 inch

8 ... 9 mm / 0.31 ... 0.35 inch

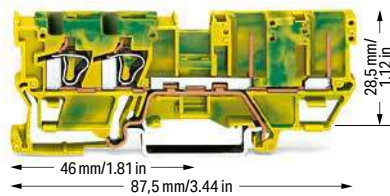

2-conductor/2-pin ground carrier terminal block

Color	Item No.	Pack. Unit
green-yellow	769-217	50

① 500 V = rated voltage
6 kV = rated impulse voltage
3 = pollution degree
250 V / 4 kV / 3 = Nominal voltage with shield contact (see Section 15)

② See current-carrying capacity curve on page 455 and upon request

Note: 1-conductor angled female plugs cannot be used.

Please observe the application notes:
Insulation stop, page 425
Jumpers, from page 426
Testing accessories, from page 420
Mini-WSB marking system, page 684

Approvals and corresponding ratings, visit www.wago.com

Accessories; 769 Series

Appropriate marking systems:
Mini-WSB/Mini-WSB Inline

Test plug adapter; 5 mm wide; for 1.5 ... 4 mm² terminal blocks

gray	280-404	100 (25)
------	---------	----------

Pin cover; with Mini-WSB marker slot

gray	769-438	100 (25)
orange	769-439	100 (25)

1-connector female plug; straight

gray	769-101	200
------	---------	-----

2-conductor female plug

gray	769-121	100
------	---------	-----

Mini-WSB Inline, plain; 1,700 WMB markers (5 mm)/reel; 5 ... 5.2 mm stretchable

white	2009-145	1
-------	----------	---

Mini-WSB marking card; white; 10 strips with 10 markers/card; 5 mm wide markers

plain	248-501	5
-------	---------	---

Staggered jumper; insulated; 5 mm wide; I_N 24 A

1 to 2	780-452	100 (25)
1 to 3	780-453	100 (25)
1 to 4	780-454	100 (25)
1 to 5	780-455	50 (25)
1 to 6	780-456	50 (25)
1 to 7	780-457	50 (25)
1 to 8	780-458	50 (25)

Push-in type wire jumper; insulated; 0.75 mm² conductor cross section; I_N 9 A

L = 60 mm	249-125	100 (10)
L = 110 mm	249-126	100 (10)
L = 250 mm	249-127	100 (10)

Test plug module; snaps together; 5 mm wide

gray	280-418	100 (25)
------	---------	----------

Spacer module; snaps together; 5 mm wide

gray	280-419	100 (25)
------	---------	----------

Test plug; with 500 mm cable; 2 mm Ø; max. 42 V

red	210-136	50
-----	---------	----

7

2-Conductor/2-Pin Carrier Terminal Blocks and 1-/2-Conductor Female Plugs X-COM®-SYSTEM Assembly Types

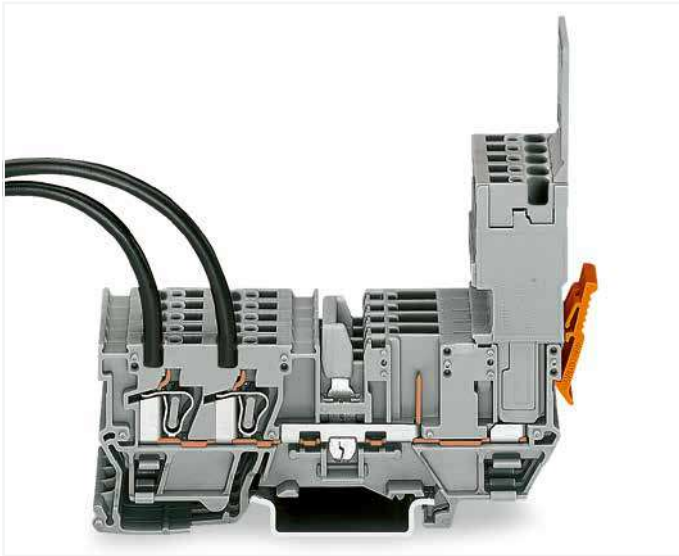

1-conductor female plug
Carrier terminal blocks can be commoned via 280 and 780 Series Jumpers and tested using a test plug adapter (280-4..).



2 x 1-conductor female plugs
Carrier terminal blocks can be commoned via 280 and 780 Series Jumpers and tested using a test plug adapter (280-4..).

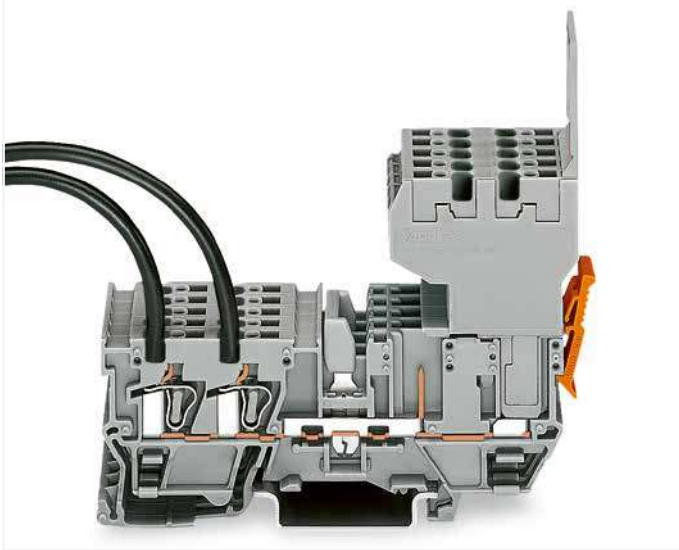

2-conductor female plug
Carrier terminal blocks can be commoned via 280 and 780 Series Jumpers and tested using a test plug adapter (280-4..).

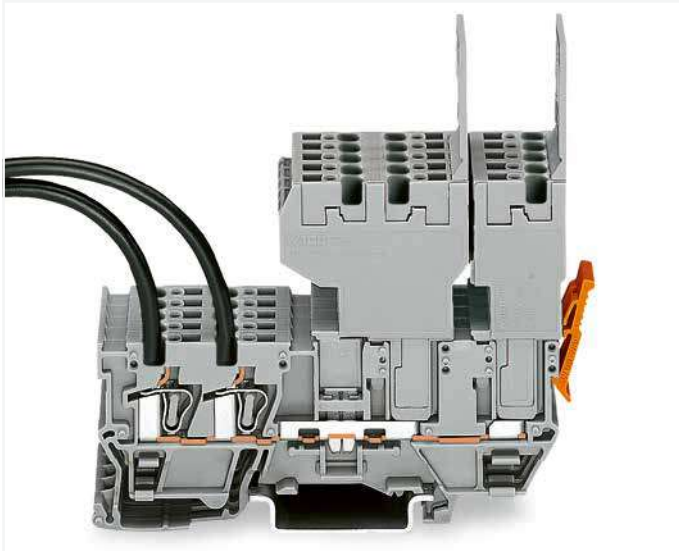

1- and 2-Conductor Female Plug
Carrier terminal blocks can only be commoned via 280 Series Adjacent and Alternate Jumpers.

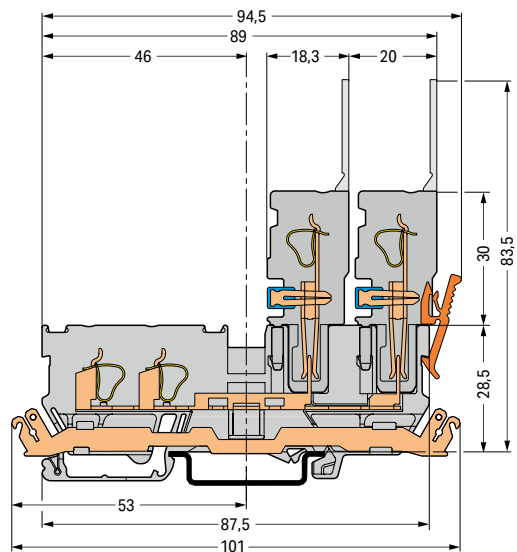
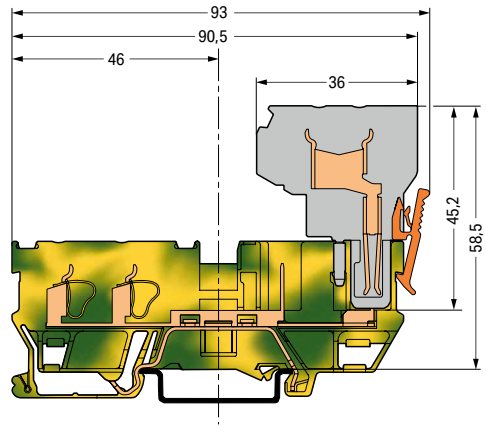

Ground carrier terminal block
Carrier terminal block; with shield contact

4-Pin Carrier Terminal Block X-COM®-SYSTEM 769 Series

Technical Data

500 V / 6 kV / 3 ①	300 V, 20 A ②
I _N 32 A ②	300 V, 20 A ②
Terminal block width: 5 mm / 0.197 inch	

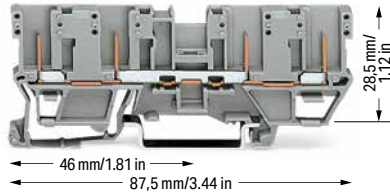

4-pin carrier terminal block

Color	Item No.	Pack. Unit
○ gray	769-151	50

4-pin carrier terminal block; with shield contact

○ gray	769-201 ①	50
--------	-----------	----

Technical Data

Terminal block width: 5 mm / 0.197 inch

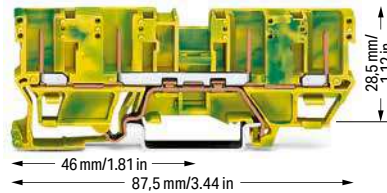

4-pin ground carrier terminal block

Color	Item No.	Pack. Unit
● green-yellow	769-207	50

① 500 V = rated voltage
6 kV = rated impulse voltage
3 = pollution degree
250 V / 4 kV / 3 = Nominal voltage with shield contact (see Section 15)

② See current-carrying capacity curve on page 455 and upon request

Note: 1-conductor angled female plugs cannot be used.

Please observe the application notes:
Jumpers, from page 426
Testing accessories, from page 421
Mini-WSB marking system, page 684

Approvals and corresponding ratings, visit www.wago.com

Accessories; 769 Series

Appropriate marking systems: Mini-WSB/Mini-WSB Inline

End and intermediate plate; 1.1 mm thick

orange	769-302	100 (25)
gray	769-301	100 (25)

Coding pin; for coding female plugs

orange	769-435	100 (25)
--------	---------	----------

Adjacent jumper; insulated; I_N = I_N terminal block

gray	280-402	200 (25)
------	---------	----------

Alternate jumper; insulated; I_N = I_N terminal block

gray	280-409	100 (25)
------	---------	----------

Staggered jumper; insulated; 5 mm wide; I_N 24 A

1 to 2	780-452	100 (25)
1 to 3	780-453	100 (25)
1 to 4	780-454	100 (25)
1 to 5	780-455	50 (25)
1 to 6	780-456	50 (25)
1 to 7	780-457	50 (25)
1 to 8	780-458	50 (25)

Push-in type wire jumper; insulated; 0.75 mm² conductor cross section; I_N 9 A

L = 60 mm	249-125	100 (10)
L = 110 mm	249-126	100 (10)
L = 250 mm	249-127	100 (10)

Test plug module; snaps together; 5 mm wide

gray	280-418	100 (25)
------	---------	----------

Spacer module; snaps together; 5 mm wide

gray	280-419	100 (25)
------	---------	----------

Test plug adapter; 5 mm wide; for 1.5 ... 4 mm² terminal blocks

gray	280-404	100 (25)
------	---------	----------

Pin cover; with Mini-WSB marker slot

gray	769-438	100 (25)
orange	769-439	100 (25)

1-conductor female plug; straight

gray	769-101	200
------	---------	-----

2-conductor female plug

gray	769-121	100
------	---------	-----

Mini-WSB Inline, plain; 1,700 WMB markers (5 mm)/reel; 5 ... 5.2 mm stretchable

white	2009-145	1
-------	----------	---

Mini-WSB marking card; white; 10 strips with 10 markers/card; 5 mm wide markers

plain	248-501	5
-------	---------	---

7

4-Pin Carrier Terminal Blocks and 1-/2-Conductor Female Plugs X-COM®-SYSTEM Assembly Types

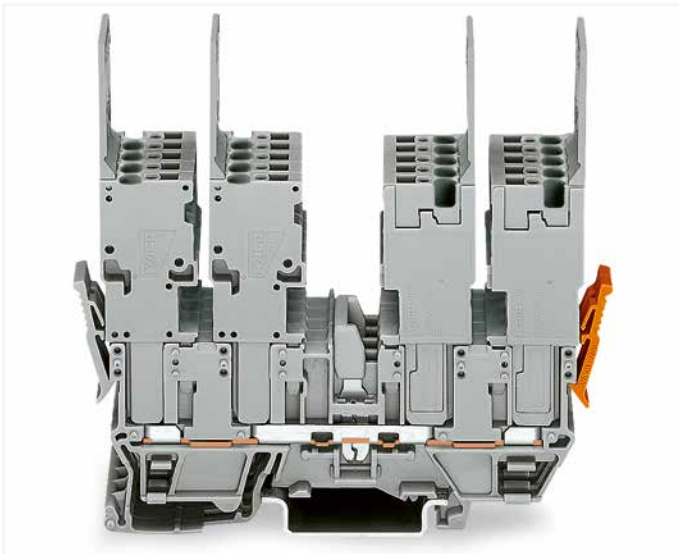

4 x 1-conductor female plugs
Carrier terminal blocks can be commoned via 280 and 780 Series Jumpers and tested using a test plug adapter (280-4..).



2 x 2-conductor female plugs
Carrier terminal blocks can be commoned via 280 and 780 Series Jumpers and tested using a test plug adapter (280-4..).

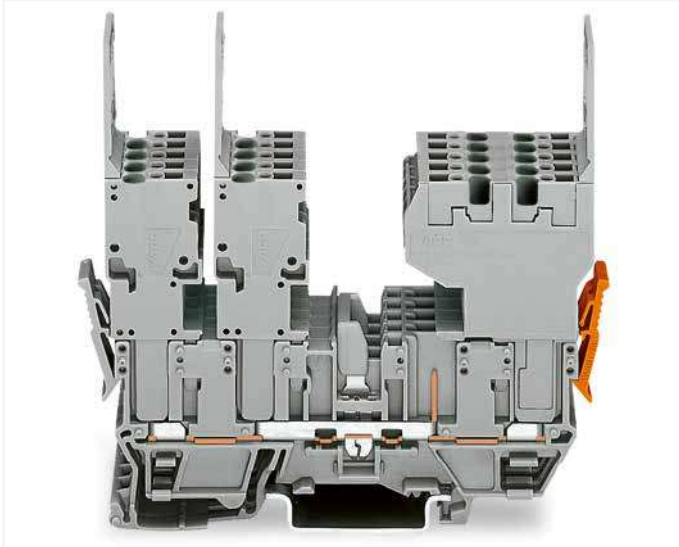

2 x 1-conductor female plug (left), 1 x 2-conductor female plug (right), may be reversed – carrier terminal blocks can be commoned via 280 and 780 Series Jumpers and tested using a test plug adapter (280-4..).

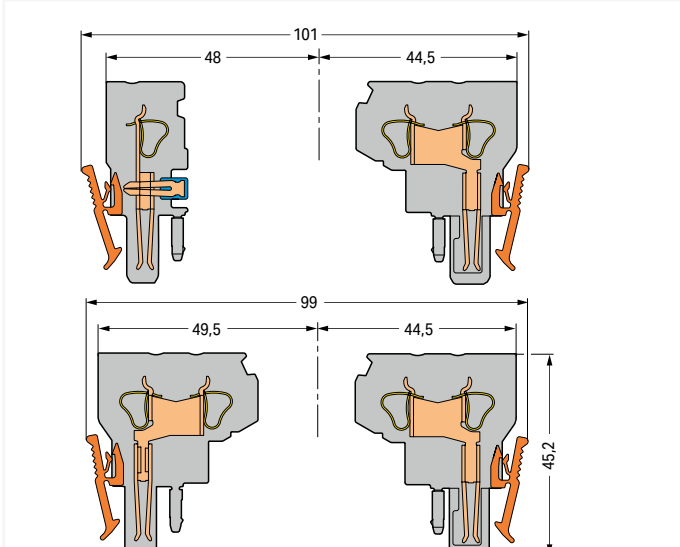

1-conductor and 2-conductor female plugs (left), 2-conductor female plug (right), may be reversed – carrier terminal blocks can only be commoned via 280 Series Adjacent and Alternate Jumpers.

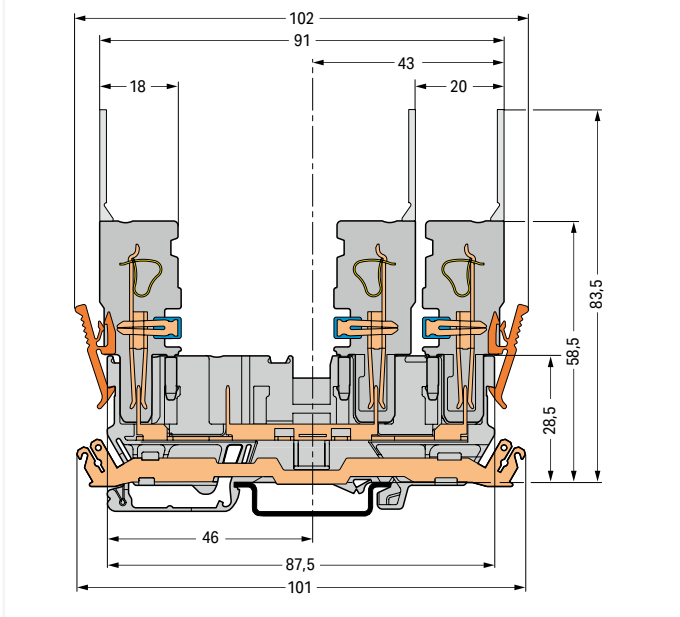

Carrier terminal block; with shield contact

2-Conductor/1-Pin Carrier Terminal Block X-COM®-SYSTEM 4 mm²; 769 Series

Technical Data

0.08 ... 4 mm ²	28 ... 12 AWG
500 V / 6 kV / 3 ①	300 V, 20 A
I _N 32 A ②	300 V, 20 A
Terminal block width: 5 mm / 0.197 inch	
8 ... 9 mm / 0.31 ... 0.35 inch	

Technical Data

0.08 ... 4 mm ²	28 ... 12 AWG
Terminal block width: 5 mm / 0.197 inch	
8 ... 9 mm / 0.31 ... 0.35 inch	

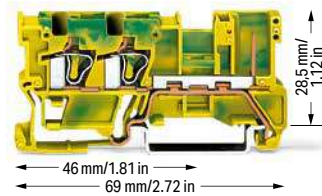
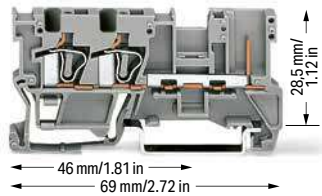

2-Conductor/1-Pin Carrier Terminal Block

Color	Item No.	Pack. Unit
gray	769-251	50
blue	769-251/000-006	50

1-conductor/1-pin ground carrier terminal block

Color	Item No.	Pack. Unit
green-yellow	769-257	50

Accessories; item-specific

Protective warning marker; with black high-voltage symbol; for 5 terminal blocks

yellow	280-415	100 (25)
--------	---------	----------

Accessories; 769 Series

Appropriate marking systems: Mini-WSB/Mini-WSB Inline

End and intermediate plate; 1.1 mm thick

orange	769-321	100 (25)
gray	769-320	100 (25)

Insulation stop; 0.08 ... 0.2 mm² "s" (0.14 mm² "f-st"); 5 pcs/strip

white	769-470	200 (25)
-------	---------	----------

Insulation stop; 0.25 ... 0.5 mm²; 5 pcs/strip

light gray	769-471	200 (25)
------------	---------	----------

Insulation stop; 0.75 ... 1 mm²; 5 pcs/strip

dark gray	769-472	200 (25)
-----------	---------	----------

Coding pin; for coding female plugs

orange	769-435	100 (25)
--------	---------	----------

Adjacent jumper; insulated; I_N = I_N terminal block

gray	280-402	200 (25)
------	---------	----------

Alternate jumper; insulated; I_N = I_N terminal block

gray	280-409	100 (25)
------	---------	----------

Push-in type wire jumper; insulated; 0.75 mm² conductor cross section; I_N 9 A

L = 60 mm	249-125	100 (10)
L = 110 mm	249-126	100 (10)
L = 250 mm	249-127	100 (10)

Staggered jumper; insulated; 5 mm wide; I_N 24 A

1 to 2	780-452	100 (25)
1 to 3	780-453	100 (25)
1 to 4	780-454	100 (25)
1 to 5	780-455	50 (25)
1 to 6	780-456	50 (25)
1 to 7	780-457	50 (25)
1 to 8	780-458	50 (25)

Test plug module; snaps together; 5 mm wide

gray	280-418	100 (25)
------	---------	----------

Spacer module; snaps together; 5 mm wide

gray	280-419	100 (25)
------	---------	----------

B-type test plug module; snaps together; 5 mm wide

gray	249-106	100 (25)
------	---------	----------

Test plug; with 500 mm cable; 2 mm Ø; max. 42 V

red	210-136	50
-----	---------	----

Test plug adapter; 5 mm wide; for 1.5 ... 4 mm² terminal blocks

gray	280-404	100 (25)
------	---------	----------

- ① 500 V = rated voltage
6 kV = rated impulse voltage
3 = pollution degree
(see Section 15)

- ② Current-carrying capacity curves upon request

Please observe the application notes:
Insulation stop, page 425
Jumpers, from page 426
Testing accessories, from page 420
Mini-WSB marking system, page 684

Approvals and corresponding ratings,
visit www.wago.com

Accessories; 769 Series

Appropriate marking systems:
Mini-WSB/Mini-WSB Inline

Pin cover; with Mini-WSB marker slot

gray	769-438	100 (25)
orange	769-439	100 (25)

1-connector female plug; straight

gray	769-101	200
------	---------	-----

1-conductor female plug; angled

gray	769-101/022-000	200
------	-----------------	-----

2-conductor female plug

gray	769-121	100
------	---------	-----

Mini-WSB Inline, plain; 1,700 WMB markers (5 mm)/reel; 5 ... 5.2 mm stretchable

white	2009-145	1
-------	----------	---

Mini-WSB marking card; white; 10 strips with 10 markers/ card; 5 mm wide markers

plain	248-501	5
-------	---------	---

7

2-Conductor/1-Pin Carrier Terminal Blocks and 1-/2-Conductor Female Plugs X-COM®-SYSTEM Assembly Types

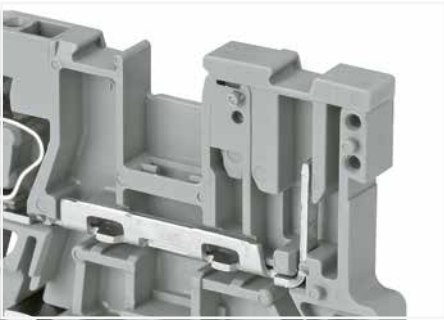

Pin cover (769-438); with Mini-WSB marker slot



1-conductor female plug
Carrier terminal blocks can be commoned via 280 and 780 Series Jumpers and tested using a test plug adapter (280-4..).

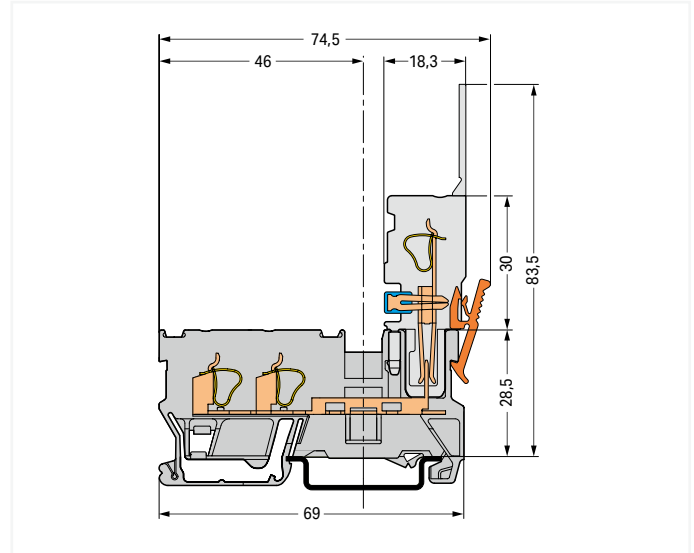

Carrier terminal block

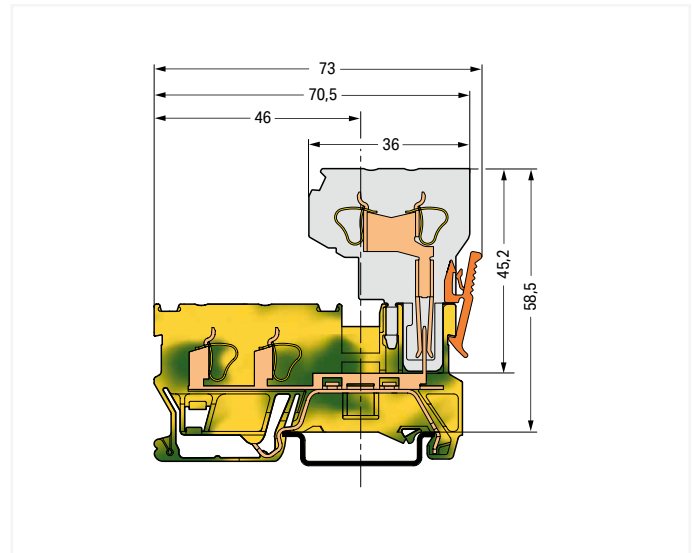

Ground carrier terminal block

1-Conductor/1-Pin Carrier Terminal Block X-COM®-SYSTEM; with Three Jumper Positions 4 mm²; 769 Series

Technical Data

0.08 ... 4 mm ²	28 ... 12 AWG
500 V / 6 kV / 3 ①	300 V, 20 A
I _N 32 A ②	300 V, 20 A @
Terminal block width: 5 mm / 0.197 inch	
8 ... 9 mm / 0.31 ... 0.35 inch	

- ① 500 V = rated voltage
6 kV = rated impulse voltage
3 = pollution degree
(see Section 15)
- ② Current-carrying capacity curves upon request

Please observe the application notes:
Insulation stop, page 425
Mini-WSB marking system, page 684

Approvals and corresponding ratings,
visit www.wago.com

Accessories; 769 Series

Appropriate marking systems:
Mini-WSB/Mini-WSB Inline

Insulation stop; 0.75 ... 1 mm²; 5 pcs/strip

	dark gray	769-472	200 (25)
--	-----------	---------	----------

Coding pin; for coding female plugs

	orange	769-435	100 (25)
--	--------	---------	----------

Adjacent jumper; insulated; I_N = I_N terminal block

	gray	280-402	200 (25)
--	------	---------	----------

Alternate jumper; insulated; I_N = I_N terminal block

	gray	280-409	100 (25)
--	------	---------	----------

Pin cover; with Mini-WSB marker slot

	gray	769-438	100 (25)
	orange	769-439	100 (25)

Accessories; 769 Series

Appropriate marking systems:
Mini-WSB/Mini-WSB Inline

1-connector female plug; straight

	gray	769-101	200
--	------	---------	-----

1-conductor female plug; angled

	gray	769-101/022-000	200
--	------	-----------------	-----

2-conductor female plug

	gray	769-121	100
--	------	---------	-----

Mini-WSB Inline, plain; 1,700 WMB markers (5 mm)/reel; 5 ... 5.2 mm stretchable

	white	2009-145	1
--	-------	----------	---

Mini-WSB marking card; white; 10 strips with 10 markers/ card; 5 mm wide markers

	plain	248-501	5
--	-------	---------	---

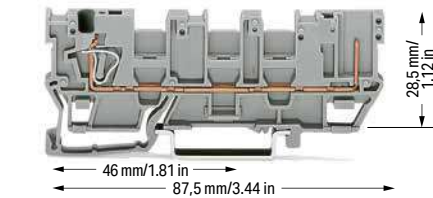

1-conductor/1-pin carrier terminal block; with three jumper positions

Color	Item No.	Pack. Unit
	769-214	50

Accessories; 769 Series

Appropriate marking systems:
Mini-WSB/Mini-WSB Inline

End and intermediate plate; 1.1 mm thick

	orange	769-316	100 (25)
	gray	769-315	100 (25)

Insulation stop; 0.08 ... 0.2 mm² "s" (0.14 mm² "f-st"); 5 pcs/strip

	white	769-470	200 (25)
--	-------	---------	----------

Insulation stop; 0.25 ... 0.5 mm²; 5 pcs/strip

	light gray	769-471	200 (25)
--	------------	---------	----------

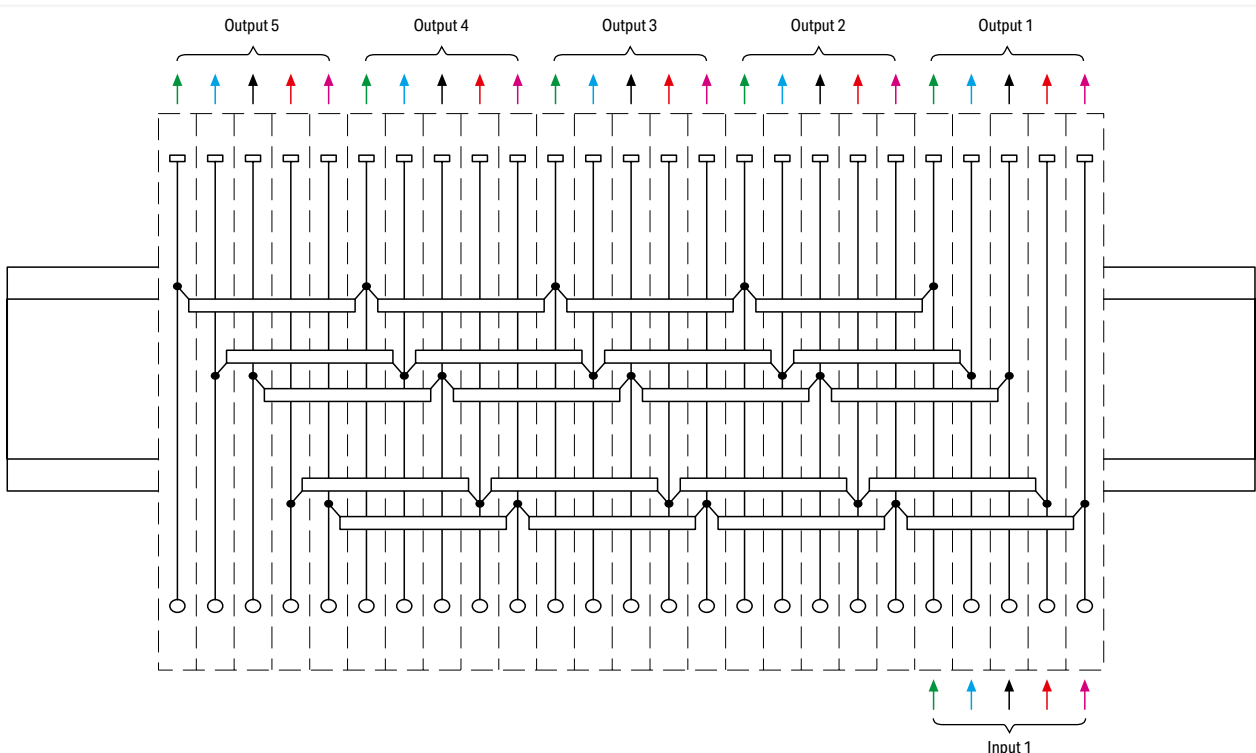

1-Conductor/1-Pin Carrier Terminal Blocks and 1-/2-Conductor Female Plugs X-COM®-SYSTEM Assembly Types

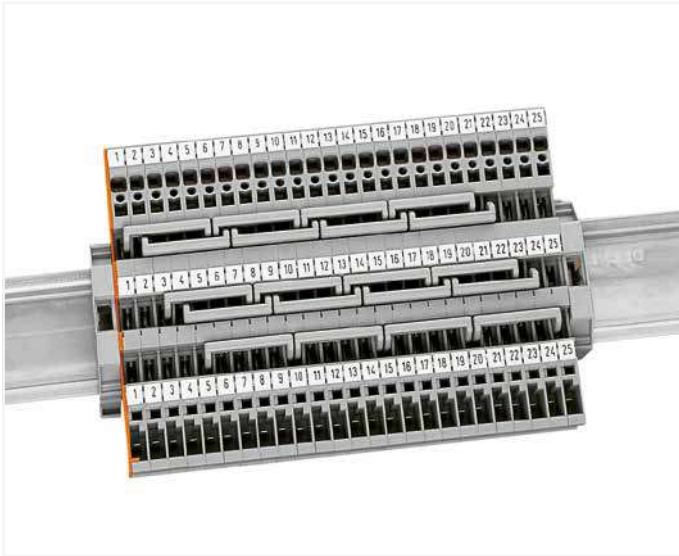

1-conductor/1-pin carrier terminal blocks; with three jumper positions
The three jumper positions allow up to six commoning options for staggered jumpers.

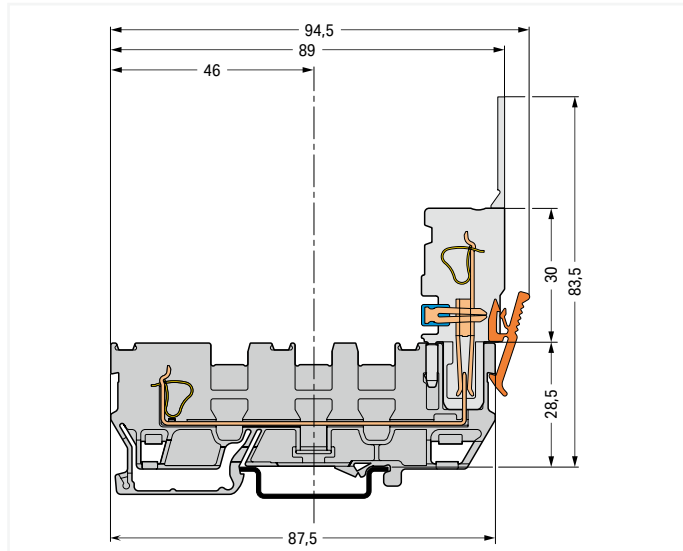
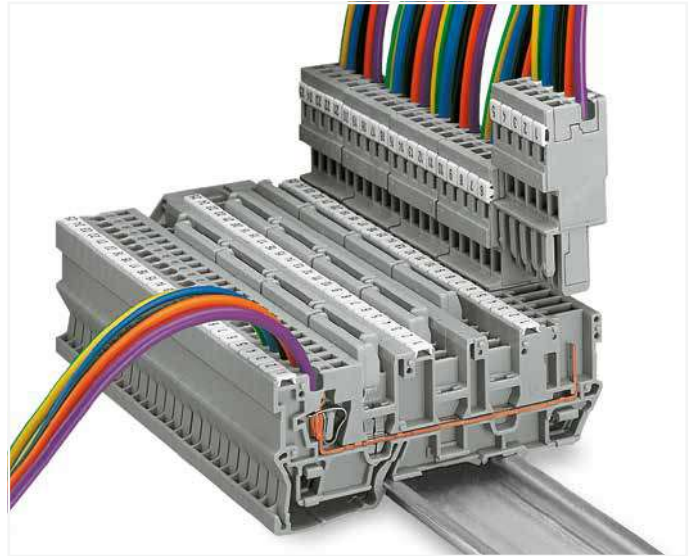

Carrier terminal block

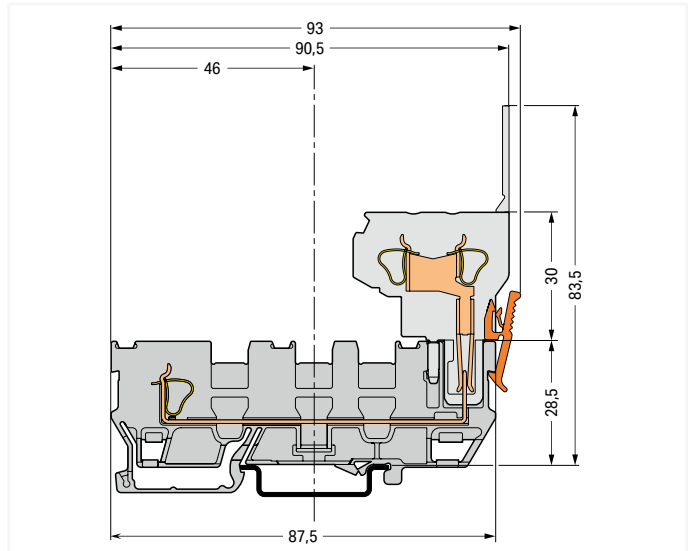

Carrier terminal block

Application examples:

Multiplication of three-phase circuits L1-L2-L3-N-PE
with pluggable outputs (e.g., for motors, frequency converters, power units)
Voltage supplies to multiple locations
(e.g., ±15 V, 0 V, +5 V, +12 V, +24 V)
Various wire-to-wire interfacing possibilities

1-Conductor/1-Pin and 2-Pin Disconnect Carrier Terminal Block X-COM®-SYSTEM 4 mm²; 769 Series

Technical Data	
0.08 ... 4 mm ²	28 ... 12 AWG
400 V / 6 kV / 3 ①	300 V, 20 A ②
I _N 16 A ②	300 V, 20 A ③
Terminal block width: 5 mm / 0.197 inch	
8 ... 9 mm / 0.31 ... 0.35 inch	

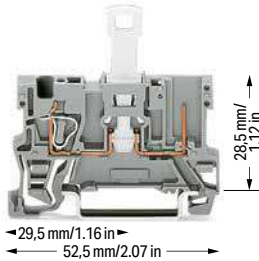

Technical Data	
400 V / 6 kV / 3 ①	300 V, 20 A ②
I _N 16 A ②	300 V, 20 A ③
Terminal block width: 5 mm / 0.197 inch	

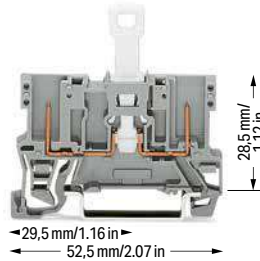

① 400 V = rated voltage
6 kV = rated impulse voltage
3 = pollution degree
250 V / 4 kV / 3 = Nominal voltage with shield contact (see Section 15)

② 16 A, 85°C upper temperature limit, current-carrying capacity curves upon request

Note: 2-conductor female plugs cannot be used.

Please observe the application notes:
Insulation stop, page 425
Mini-WSB marking system, page 684

Approvals and corresponding ratings, visit www.wago.com

Accessories; 769 Series

Appropriate marking systems:
Mini-WSB/Mini-WSB Inline

Mini-WSB Inline, plain; 1,700 WMB markers (5 mm)/reel; 5 ... 5.2 mm stretchable

white	2009-145	1
-------	----------	---

Mini-WSB marking card; white; 10 strips with 10 markers/
card; 5 mm wide markers

plain	248-501	5
-------	---------	---

1-conductor/1-pin disconnect carrier terminal block		
Color	Item No.	Pack. Unit
gray	769-232	50

2-pin disconnect carrier terminal block		
Color	Item No.	Pack. Unit
gray	769-222	50

1-conductor/1-pin disconnect carrier terminal block; with shield contact		
Color	Item No.	Pack. Unit
gray	769-233 ①	50

2-pin disconnect carrier terminal block; with shield contact		
Color	Item No.	Pack. Unit
gray	769-223 ①	50

Accessories; item-specific			
End and intermediate plate; 1.1 mm thick			
orange	769-308	100 (25)	
gray	769-307	100 (25)	

Accessories; item-specific			
End and intermediate plate; 1.1 mm thick			
orange	769-306	100 (25)	
gray	769-305	100 (25)	

Insulation stop; 0.08 ... 0.2 mm ² "s" (0.14 mm ² "f-st"); 5 pcs/strip			
white	769-470	200 (25)	

Insulation stop; 0.25 ... 0.5 mm ² ; 5 pcs/strip			
light gray	769-471	200 (25)	

Insulation stop; 0.75 ... 1 mm ² ; 5 pcs/strip			
dark gray	769-472	200 (25)	

Protective warning marker; with black high-voltage symbol; for 5 terminal blocks			
yellow	280-415	100 (25)	

Test plug; with 500 mm cable; 2 mm Ø; max. 42 V			
red	210-136	50	

Accessories; 769 Series			
Appropriate marking systems: Mini-WSB/Mini-WSB Inline			

Coding pin; for coding female plugs			
orange	769-435	100 (25)	

1-connector female plug; straight			
gray	769-101	200	

Disconnect lock; for disconnect tab used on disconnect terminal blocks (280/281 and 769 Series)			
red	709-170	200 (25)	

1-conductor female plug; angled			
gray	769-101/022-000	200	

7

1-Conductor/1-Pin and 2-Pin Disconnect Carrier Terminal Block X-COM®-SYSTEM; with Two Jumper Positions

4 mm²; 769 Series

Technical Data

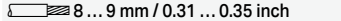
0.08 ... 4 mm ²	28 ... 12 AWG
400 V / 6 kV / 3 ①	300 V, 20 A ②
I _N 16 A ②	300 V, 20 A ③
Terminal block width: 5 mm / 0.197 inch	
 8 ... 9 mm / 0.31 ... 0.35 inch	

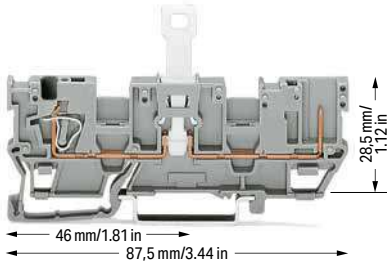

1-conductor/1-pin disconnect carrier terminal block; with two jumper positions

Color	Item No.	Pack. Unit
○ gray	769-212	50

1-conductor/1-pin disconnect carrier terminal block; with shield contact; with two jumper positions

○ gray	769-213 ①	50
--------	-----------	----

Accessories; item-specific

End and intermediate plate; 1.1 mm thick

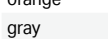
 orange	769-312	100 (25)
 gray	769-311	100 (25)

Separator; oversized; 1.1 mm thick

 orange	769-314	100 (25)
--	---------	----------

Insulation stop; 0.08 ... 0.2 mm² "s" (0.14 mm² "f-st"); 5 pcs/strip

 white	769-470	200 (25)
---	---------	----------

Insulation stop; 0.25 ... 0.5 mm²; 5 pcs/strip

 light gray	769-471	200 (25)
--	---------	----------

Insulation stop; 0.75 ... 1 mm²; 5 pcs/strip

 dark gray	769-472	200 (25)
---	---------	----------

Protective warning marker; with black high-voltage symbol; for 5 terminal blocks

 yellow	280-415	100 (25)
--	---------	----------

Test plug; with 500 mm cable; 2 mm Ø; max. 42 V

 red	210-136	50
---	---------	----

Accessories; 769 Series

Appropriate marking systems: Mini-WSB/Mini-WSB Inline

Coding pin; for coding female plugs

 orange	769-435	100 (25)
--	---------	----------

Technical Data

400 V / 6 kV / 3 ①	300 V, 20 A ②
I _N 16 A ②	300 V, 20 A ③
Terminal block width: 5 mm / 0.197 inch	

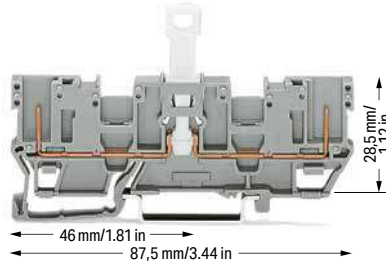

2-pin disconnect carrier terminal block; with two jumper positions

Color	Item No.	Pack. Unit
○ gray	769-202	50

2-pin disconnect carrier terminal block; with shield contact; with two jumper positions

○ gray	769-203 ①	50
--------	-----------	----

Accessories; item-specific

End and intermediate plate; 1.1 mm thick

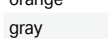
 orange	769-310	100 (25)
 gray	769-309	100 (25)

Separator; oversized; 1.1 mm thick

 orange	769-313	100 (25)
--	---------	----------

① 400 V = rated voltage
6 kV = rated impulse voltage
3 = pollution degree
250 V / 4 kV / 3 = Nominal voltage with shield contact (see Section 15)

② 16 A, 85°C upper temperature limit, current-carrying capacity curves upon request

Please observe the application notes:
Insulation stop, page 425
Jumpers, from page 426
Testing accessories, from page 422
Mini-WSB marking system, page 684

Approvals and corresponding ratings, visit www.wago.com

Accessories; 769 Series

Appropriate marking systems:
Mini-WSB/Mini-WSB Inline







Adjacent jumper; insulated; I_N = I_N terminal block

 gray	280-402	200 (25)
--	---------	----------

Alternate jumper; insulated; I_N = I_N terminal block

 gray	280-409	100 (25)
--	---------	----------

Staggered jumper; insulated; 5 mm wide; I_N 24 A

 1 to 2	780-452	100 (25)
 1 to 3	780-453	100 (25)
 1 to 4	780-454	100 (25)
 1 to 5	780-455	50 (25)
 1 to 6	780-456	50 (25)
 1 to 7	780-457	50 (25)
 1 to 8	780-458	50 (25)

Push-in type wire jumper; insulated; 0.75 mm² conductor cross section; I_N 9 A

 L = 60 mm	249-125	100 (10)
 L = 110 mm	249-126	100 (10)
 L = 250 mm	249-127	100 (10)

Test plug module; snaps together; 5 mm wide

 gray	280-418	100 (25)
--	---------	----------

1-connector female plug; straight

 gray	769-101	200
--	---------	-----

1-conductor female plug; angled

 gray	769-101/022-000	200
--	-----------------	-----

2-conductor female plug

 gray	769-121	100
--	---------	-----

Mini-WSB Inline, plain; 1,700 WMB markers (5 mm)/reel; 5 ... 5.2 mm stretchable

 white	2009-145	1
---	----------	---

Mini-WSB marking card; white; 10 strips with 10 markers/card; 5 mm wide markers

 plain	248-501	5
---	---------	---

1-Conductor/1-Pin and 2-Pin Diode Carrier Terminal Block X-COM®-SYSTEM 4 mm²; 769 Series

Technical Data	
0.08 ... 4 mm ²	28 ... 12 AWG
U _N 250 V; U _{RM} 1000 V	
1N4007 – 0.5 A continuous current	
Terminal block width: 5 mm / 0.197 inch	
8 ... 9 mm / 0.31 ... 0.35 inch	

Technical Data	
U _N 250 V; U _{RM} 1000 V	
1N4007 – 0.5 A continuous current	
Terminal block width: 5 mm / 0.197 inch	

Note: 2-conductor female plugs cannot be used.

Please observe the application notes:
Insulation stop, page 425
Mini-WSB marking system, page 684

Approvals and corresponding ratings,
visit www.wago.com

Accessories; 769 Series

Appropriate marking systems:
Mini-WSB/Mini-WSB Inline

Mini-WSB Inline, plain; 1,700 WMB markers (5 mm)/reel; 5 ... 5.2 mm stretchable

	white	2009-145	1
--	-------	----------	---

Mini-WSB marking card; white; 10 strips with 10 markers/
card; 5 mm wide markers

	plain	248-501	5
--	-------	---------	---

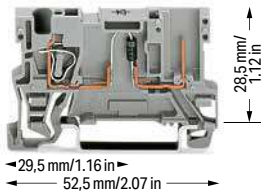

769-238/281-411 769-238/281-410

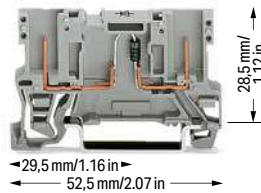

769-228/281-411 769-228/281-410

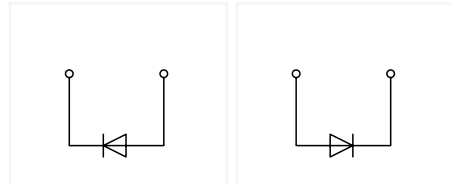
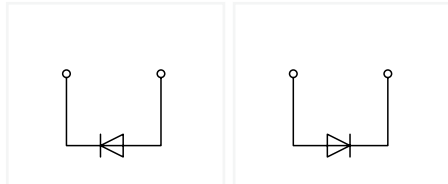

1-conductor/1-pin diode carrier terminal block		
	Item No.	Pack. Unit
○ Anode, right side	769-238/281-411	100
○ Anode, left side	769-238/281-410	100

2-pin diode carrier block		
	Item No.	Pack. Unit
○ Anode, right side	769-228/281-411	100
○ Anode, left side	769-228/281-410	100

Accessories; item-specific			
End and intermediate plate; 1.1 mm thick			
	orange	769-308	100 (25)
	gray	769-307	100 (25)

Accessories; item-specific			
End and intermediate plate; 1.1 mm thick			
	orange	769-306	100 (25)
	gray	769-305	100 (25)

Insulation stop; 0.08 ... 0.2 mm ² "s" (0.14 mm ² "f-st"); 5 pcs/strip			
	white	769-470	200 (25)

Insulation stop; 0.25 ... 0.5 mm ² ; 5 pcs/strip			
	light gray	769-471	200 (25)

Insulation stop; 0.75 ... 1 mm ² ; 5 pcs/strip			
	dark gray	769-472	200 (25)

Protective warning marker; with black high-voltage symbol; for 5 terminal blocks			
	yellow	280-415	100 (25)

Test plug; with 500 mm cable; 2 mm Ø; max. 42 V			
	red	210-136	50

Accessories; 769 Series
Appropriate marking systems: Mini-WSB/Mini-WSB Inline

Coding pin; for coding female plugs			
	orange	769-435	100 (25)

1-connector female plug; straight			
	gray	769-101	200

1-conductor female plug; angled			
	gray	769-101/022-000	200

7

1-Conductor/1-Pin and 2-Din Diode Carrier Terminal Block X-COM®-SYSTEM; with Two Jumper Positions

4 mm²; 769 Series

Technical Data	
0.08 ... 4 mm ²	28 ... 12 AWG
U _N 250 V; U _{RM} 1000 V	
1N4007 – 0.5 A continuous current	
Terminal block width: 5 mm / 0.197 inch	
8 ... 9 mm / 0.31 ... 0.35 inch	

Technical Data	
U _N 250 V; U _{RM} 1000 V	
1N4007 – 0.5 A continuous current	
Terminal block width: 5 mm / 0.197 inch	

Please observe the application notes:
 Insulation stop, page 425
 Jumpers, from page 426
 Testing accessories, from page 422
 Mini-WSB marking system, page 684

Approvals and corresponding ratings, visit www.wago.com

Accessories; 769 Series
 Appropriate marking systems:
 Mini-WSB/Mini-WSB Inline

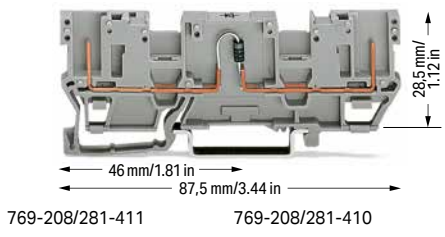
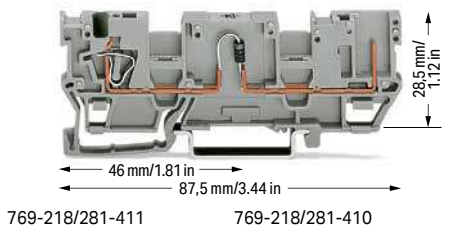

Coding pin; for coding female plugs			
	orange	769-435	100 (25)

Adjacent jumper; insulated; I _N = I _N terminal block			
	gray	280-402	200 (25)

Alternate jumper; insulated; I _N = I _N terminal block			
	gray	280-409	100 (25)

Staggered jumper; insulated; 5 mm wide; I _N 24 A			
	1 to 2	780-452	100 (25)
	1 to 3	780-453	100 (25)
	1 to 4	780-454	100 (25)
	1 to 5	780-455	50 (25)
	1 to 6	780-456	50 (25)
	1 to 7	780-457	50 (25)
	1 to 8	780-458	50 (25)

Push-in type wire jumper; insulated; 0.75 mm ² conductor cross section; I _N 9 A			
	L = 60 mm	249-125	100 (10)
	L = 110 mm	249-126	100 (10)
	L = 250 mm	249-127	100 (10)

Test plug module; snaps together; 5 mm wide			
	gray	280-418	100 (25)

Spacer module; snaps together; 5 mm wide			
	gray	280-419	100 (25)

1-connector female plug; straight			
	gray	769-101	200

1-conductor female plug; angled			
	gray	769-101/022-000	200

2-conductor female plug			
	gray	769-121	100

Mini-WSB Inline, plain; 1,700 WMB markers (5 mm)/reel; 5 ... 5.2 mm stretchable			
	white	2009-145	1

Mini-WSB marking card; white; 10 strips with 10 markers/card; 5 mm wide markers			
	plain	248-501	5

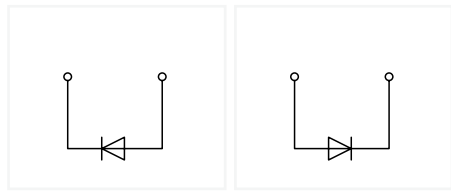

1-conductor/1-pin diode carrier terminal block; with two jumper positions

	Item No.	Pack. Unit
○ Anode, right side	769-218/281-411	50
○ Anode, left side	769-218/281-410	50

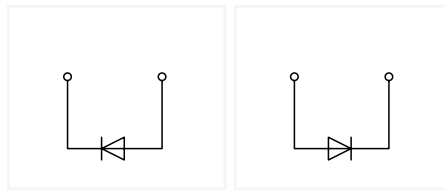

2-pin diode carrier terminal block; with two jumper positions

	Item No.	Pack. Unit
○ Anode, right side	769-208/281-411	50
○ Anode, left side	769-208/281-410	50

Accessories; item-specific

End and intermediate plate; 1.1 mm thick			
	orange	769-312	100 (25)
	gray	769-311	100 (25)

Separator; oversized; 1.1 mm thick			
	orange	769-314	100 (25)

Insulation stop; 0.08 ... 0.2 mm ² "s" (0.14 mm ² "f-st"); 5 pcs/strip			
	white	769-470	200 (25)

Insulation stop; 0.25 ... 0.5 mm ² ; 5 pcs/strip			
	light gray	769-471	200 (25)

Insulation stop; 0.75 ... 1 mm ² ; 5 pcs/strip			
	dark gray	769-472	200 (25)

Protective warning marker; with black high-voltage symbol; for 5 terminal blocks			
	yellow	280-415	100 (25)

Test plug; with 500 mm cable; 2 mm Ø; max. 42 V			
	red	210-136	50

1-Conductor/1-Pin and 2-Pin LED Carrier Terminal Block X-COM®-SYSTEM 4 mm²; 769 Series

Technical Data	
0.08 ... 4 mm ²	28 ... 12 AWG
24 VDC	
I _F 0.025 A max.	
Terminal block width: 5 mm / 0.197 inch	
8 ... 9 mm / 0.31 ... 0.35 inch	

Technical Data	
24 VDC	
I _F 0.025 A max.	
Terminal block width: 5 mm / 0.197 inch	

Note: 2-conductor female plugs cannot be used.

Please observe the application notes:
Insulation stop, page 425
Mini-WSB marking system, page 684

Approvals and corresponding ratings, visit www.wago.com

Accessories; 769 Series

Appropriate marking systems:
Mini-WSB/Mini-WSB Inline

Mini-WSB Inline, plain; 1,700 WMB markers (5 mm)/reel; 5 ... 5.2 mm stretchable

	white	2009-145	1
--	-------	----------	---

Mini-WSB marking card; white; 10 strips with 10 markers/card; 5 mm wide markers

	plain	248-501	5
--	-------	---------	---

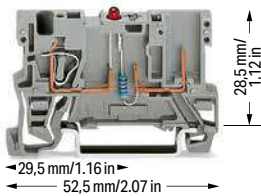

769-239/281-413

769-239/281-434

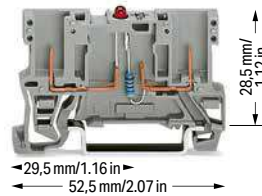

769-229/281-413

769-229/281-434

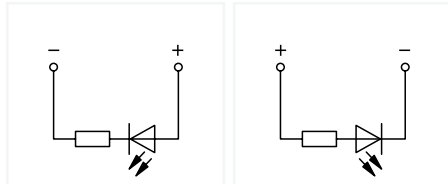

1-cond./1-pin LED carrier block

	Item No.	Pack. Unit
○ Anode, right side	769-239/281-413	100
○ Anode, left side	769-239/281-434	100

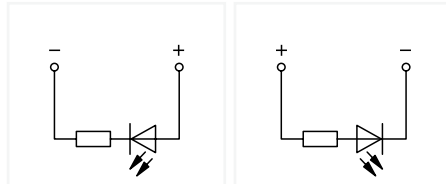

2-pin LED carrier block

	Item No.	Pack. Unit
○ Anode, right side	769-229/281-413	100
○ Anode, left side	769-229/281-434	100

Accessories; item-specific

End and intermediate plate; 1.1 mm thick

	orange	769-308	100 (25)
	gray	769-307	100 (25)

Insulation stop; 0.08 ... 0.2 mm² "s" (0.14 mm² "f-st"); 5 pcs/strip

	white	769-470	200 (25)
--	-------	---------	----------

Insulation stop; 0.25 ... 0.5 mm²; 5 pcs/strip

	light gray	769-471	200 (25)
--	------------	---------	----------

Insulation stop; 0.75 ... 1 mm²; 5 pcs/strip

	dark gray	769-472	200 (25)
--	-----------	---------	----------

Protective warning marker; with black high-voltage symbol; for 5 terminal blocks

	yellow	280-415	100 (25)
--	--------	---------	----------

Test plug; with 500 mm cable; 2 mm Ø; max. 42 V

	red	210-136	50
--	-----	---------	----

Accessories; 769 Series

Appropriate marking systems: Mini-WSB/Mini-WSB Inline

Coding pin; for coding female plugs

	orange	769-435	100 (25)
--	--------	---------	----------

1-connector female plug; straight

	gray	769-101	200
--	------	---------	-----

1-conductor female plug; angled

	gray	769-101/022-000	200
--	------	-----------------	-----

7

1-Conductor/1-Pin and 2-Pin LED Carrier Terminal Block X-COM®-SYSTEM; with Two Jumper Positions

4 mm²; 769 Series

Technical Data	
0.08 ... 4 mm ²	28 ... 12 AWG
24 VDC	
I _F 0.025 A max.	
Terminal block width: 5 mm / 0.197 inch	
8 ... 9 mm / 0.31 ... 0.35 inch	

Technical Data	
24 VDC	
I _F 0.025 A max.	
Terminal block width: 5 mm / 0.197 inch	

Please observe the application notes:
 Insulation stop, page 425
 Jumpers, from page 426
 Testing accessories, from page 422
 Mini-WSB marking system, page 684

Approvals and corresponding ratings, visit www.wago.com

Accessories; 769 Series

Appropriate marking systems:
 Mini-WSB/Mini-WSB Inline

Coding pin; for coding female plugs

orange	769-435	100 (25)
--------	---------	----------

Adjacent jumper; insulated; I_N = I_N terminal block

gray	280-402	200 (25)
------	---------	----------

Alternate jumper; insulated; I_N = I_N terminal block

gray	280-409	100 (25)
------	---------	----------

Staggered jumper; insulated; 5 mm wide; I_N 24 A

1 to 2	780-452	100 (25)
1 to 3	780-453	100 (25)
1 to 4	780-454	100 (25)
1 to 5	780-455	50 (25)
1 to 6	780-456	50 (25)
1 to 7	780-457	50 (25)
1 to 8	780-458	50 (25)

Push-in type wire jumper; insulated; 0.75 mm² conductor cross section; I_N 9 A

L = 60 mm	249-125	100 (10)
L = 110 mm	249-126	100 (10)
L = 250 mm	249-127	100 (10)

Test plug module; snaps together; 5 mm wide

gray	280-418	100 (25)
------	---------	----------

Spacer module; snaps together; 5 mm wide

gray	280-419	100 (25)
------	---------	----------

1-connector female plug; straight

gray	769-101	200
------	---------	-----

1-conductor female plug; angled

gray	769-101/022-000	200
------	-----------------	-----

2-conductor female plug

gray	769-121	100
------	---------	-----

Mini-WSB Inline, plain; 1,700 WMB markers (5 mm)/reel; 5 ... 5.2 mm stretchable

white	2009-145	1
-------	----------	---

Mini-WSB marking card; white; 10 strips with 10 markers/card; 5 mm wide markers

plain	248-501	5
-------	---------	---

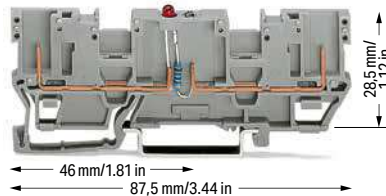
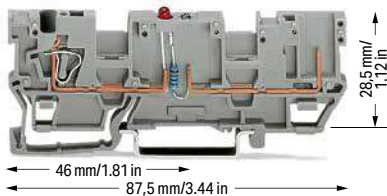

769-219/281-434

769-219/281-413

769-209/281-434

769-209/281-413

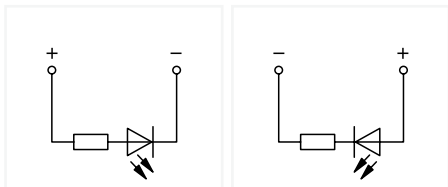

1-conductor/1-pin LED carrier terminal block; with two jumper positions

	Item No.	Pack. Unit
○ Anode, left side	769-219/281-434	50
○ Anode, right side	769-219/281-413	50

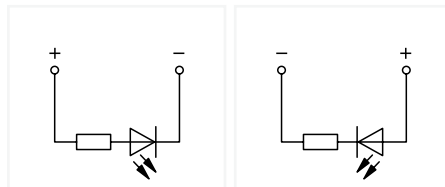

2-pin LED carrier terminal block; with two jumper positions

	Item No.	Pack. Unit
○ Anode, left side	769-209/281-434	50
○ Anode, right side	769-209/281-413	50

Accessories; item-specific

End and intermediate plate; 1.1 mm thick

orange	769-312	100 (25)
gray	769-311	100 (25)

Separator; oversized; 1.1 mm thick

orange	769-314	100 (25)
--------	---------	----------

Insulation stop; 0.08 ... 0.2 mm² "s" (0.14 mm² "f-st"); 5 pcs/strip

white	769-470	200 (25)
-------	---------	----------

Insulation stop; 0.25 ... 0.5 mm²; 5 pcs/strip

light gray	769-471	200 (25)
------------	---------	----------

Insulation stop; 0.75 ... 1 mm²; 5 pcs/strip

dark gray	769-472	200 (25)
-----------	---------	----------

Protective warning marker; with black high-voltage symbol; for 5 terminal blocks

yellow	280-415	100 (25)
--------	---------	----------

Test plug; with 500 mm cable; 2 mm Ø; max. 42 V

red	210-136	50
-----	---------	----

1-Conductor/1-Pin and 2-Pin Carrier Terminal Blocks and 1-Conductor Female Plugs X-COM®-SYSTEM Assembly Types



1-conductor female plug
Disconnect carrier terminal blocks cannot be commoned.



1-conductor female plug
Disconnect carrier terminal blocks cannot be commoned.



1-conductor female plug
Diode carrier terminal blocks cannot be commoned.

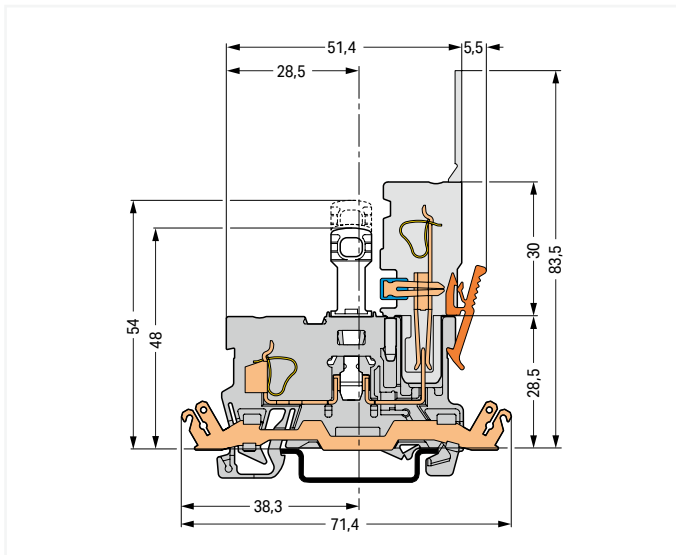

Disconnect carrier terminal block; with shield contact



1-conductor female plug
LED carrier terminal blocks cannot be commoned.

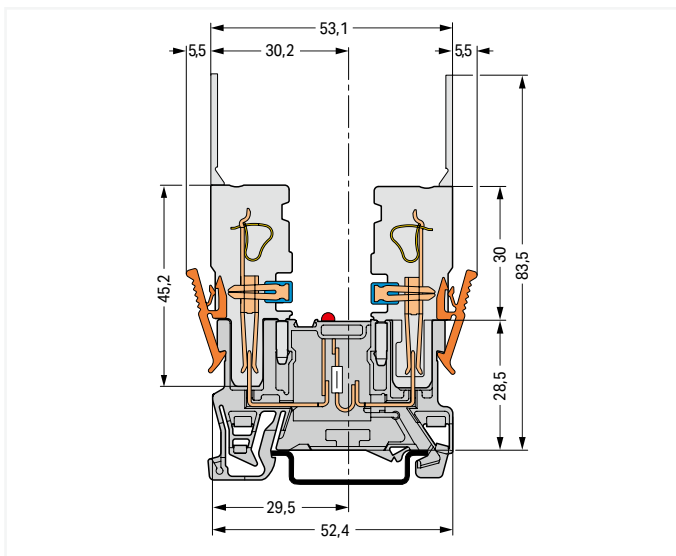

LED carrier terminal block

7

1-Conductor/1-Pin and 2-Pin Carrier Terminal Blocks X-COM®-SYSTEM; with Two Jumper Positions and 1-/2-Conductor Female Plugs Assembly Types

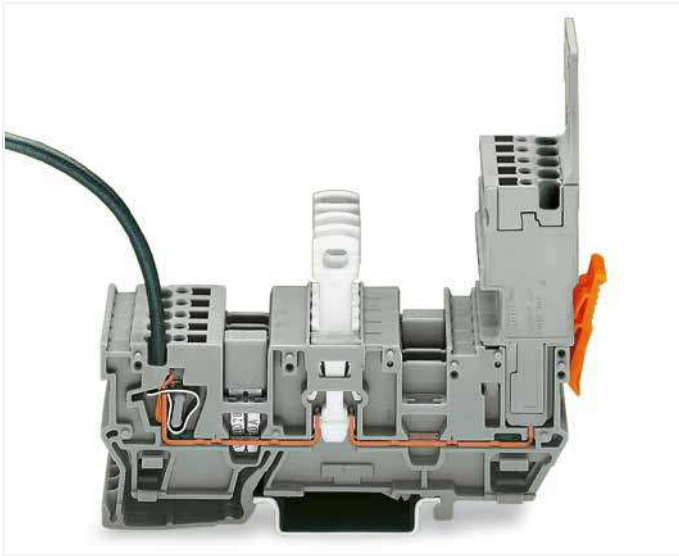

1-conductor female plug
Disconnect carrier terminal blocks can be commoned via 280 and 780 Series Jumpers and tested using a test plug adapter (280-4..).

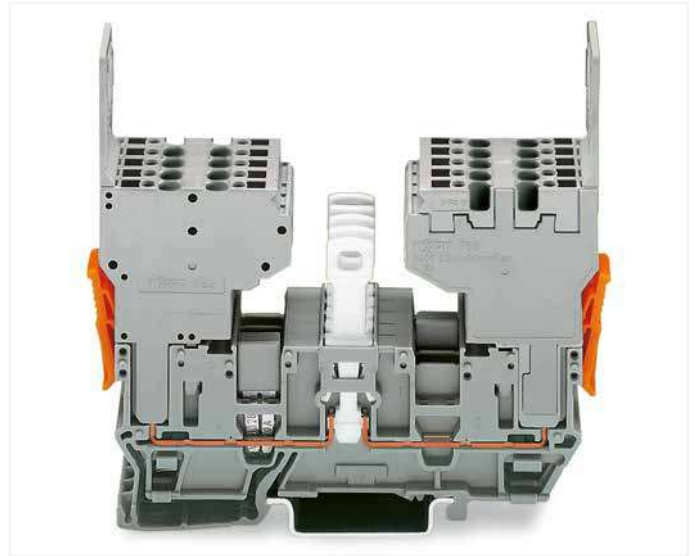

2-conductor female plug
Disconnect carrier terminal blocks can be commoned via 280 and 780 Series Jumpers.



2-conductor female plug
Diode carrier terminal blocks can be commoned via 280 and 780 Series Jumpers and tested using a test plug adapter (280-4..).

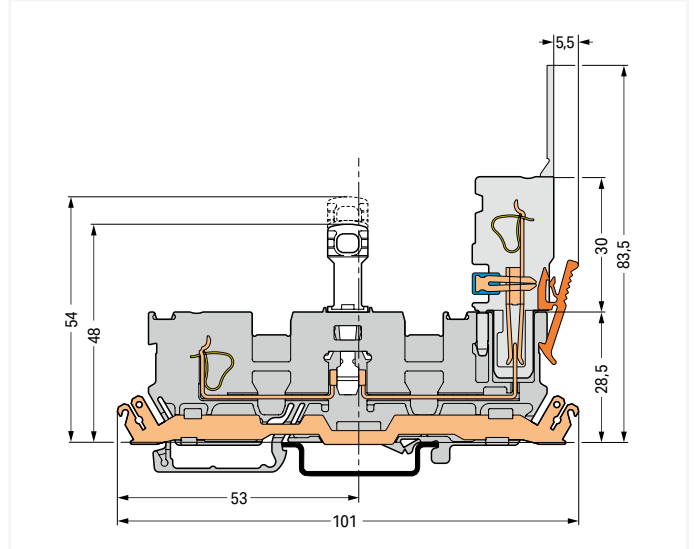

Disconnect carrier terminal block; with shield contact

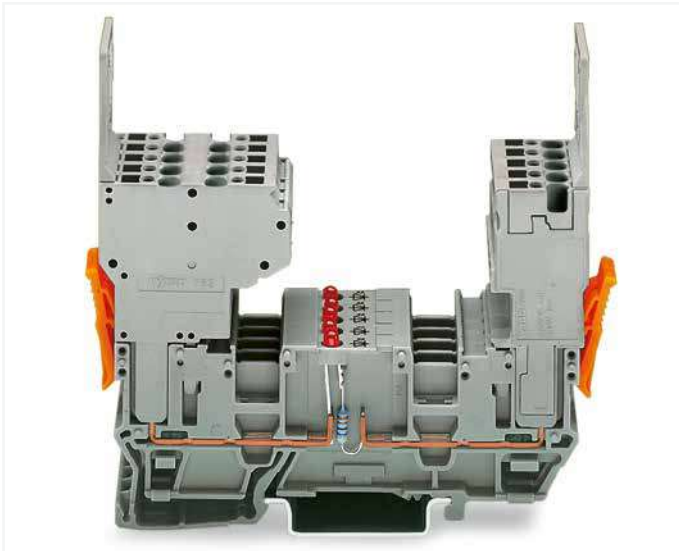

2-conductor and 1-conductor female plugs (may be reversed)
LED carrier terminal blocks can be commoned via 280 and 780 Series Jumpers and tested using a test plug adapter (280-4..).

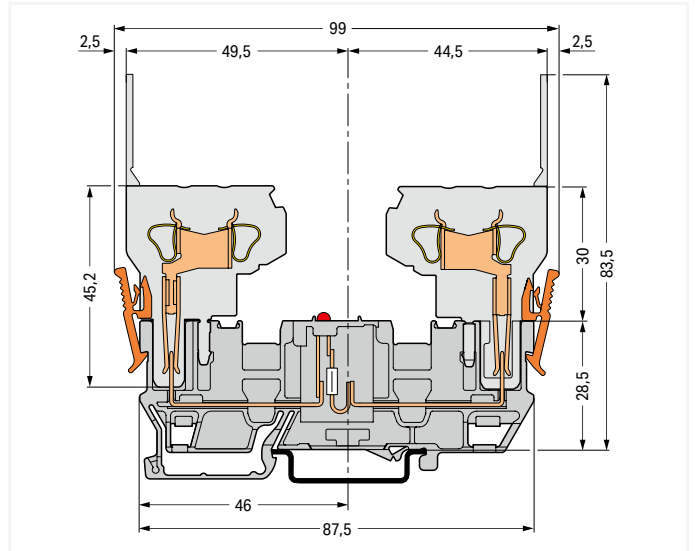

LED carrier terminal block

1-Conductor/1-Conductor Pin Disconnect Carrier Terminal Block X-COM®-SYSTEM; with Two Jumper Positions

4 mm²; 769 Series

Technical Data

0.08 ... 4 mm² | 28 ... 12 AWG

400 V / 6 kV / 3 ①

I_N 16 A

Terminal block width: 5 mm / 0.197 inch

8 ... 9 mm / 0.31 ... 0.35 inch

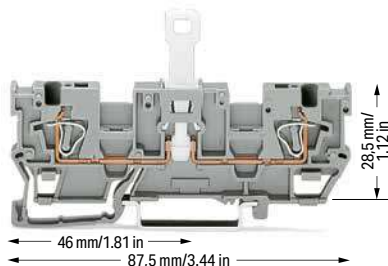

1-conductor/1-conductor pin disconnect carrier terminal block; with two jumper positions

Color	Item No.	Pack. Unit
○ gray	769-242	50

1-conductor/1-conductor disconnect carrier terminal block; with shield contact

○ gray	769-243 ①	50
--------	-----------	----

Accessories; 769 Series

Appropriate marking systems:
Mini-WSB/Mini-WSB Inline

End and intermediate plate; 1.1 mm thick

orange	769-318	100 (25)
gray	769-317	100 (25)

Separator plate; oversized; 1.1 mm thick

orange	769-319	100 (25)
--------	---------	----------

Insulation stop; 0.08 ... 0.2 mm² "s" (0.14 mm² "f-st"); 5 pcs/strip

white	769-470	200 (25)
-------	---------	----------

Insulation stop; 0.25 ... 0.5 mm²; 5 pcs/strip

light gray	769-471	200 (25)
------------	---------	----------

Insulation stop; 0.75 ... 1 mm²; 5 pcs/strip

dark gray	769-472	200 (25)
-----------	---------	----------

Protective warning marker; with black high-voltage symbol; for 5 terminal blocks

yellow	280-415	100 (25)
--------	---------	----------

Adjacent jumper; insulated; I_N = I_N terminal block

gray	280-402	200 (25)
------	---------	----------

Alternate jumper; insulated; I_N = I_N terminal block

gray	280-409	100 (25)
------	---------	----------

- ① 400 V = rated voltage
6 kV = rated impulse voltage
3 = pollution degree
250 V / 4 kV / 3 = Nominal voltage with shield contact (see Section 15)

Please observe the application notes:
Insulation stop, page 425
Jumpers, from page 426
Testing accessories, from page 422
Mini-WSB marking system, page 684

Approvals and corresponding ratings,
visit www.wago.com

Accessories; 769 Series

Appropriate marking systems:
Mini-WSB/Mini-WSB Inline

Staggered jumper; insulated; 5 mm wide; I_N 24 A

1 to 2	780-452	100 (25)
1 to 3	780-453	100 (25)
1 to 4	780-454	100 (25)
1 to 5	780-455	50 (25)
1 to 6	780-456	50 (25)
1 to 7	780-457	50 (25)
1 to 8	780-458	50 (25)

Push-in type wire jumper; insulated; 0.75 mm² conductor cross section; I_N 9 A

L = 60 mm	249-125	100 (10)
L = 110 mm	249-126	100 (10)
L = 250 mm	249-127	100 (10)

Test plug module; snaps together; 5 mm wide

gray	280-418	100 (25)
------	---------	----------

Spacer module; snaps together; 5 mm wide

gray	280-419	100 (25)
------	---------	----------

Test plug; with 500 mm cable; 2 mm Ø; max. 42 V

red	210-136	50
-----	---------	----

Test plug adapter; 5 mm wide; for 1.5 ... 4 mm² terminal blocks

gray	280-404	100 (25)
------	---------	----------

Disconnect lock; for disconnect tab used on disconnect terminal blocks (280/281 and 769 Series)

red	709-170	200 (25)
-----	---------	----------

Mini-WSB Inline, plain; 1,700 WMB markers (5 mm)/reel; 5 ... 5.2 mm stretchable

white	2009-145	1
-------	----------	---

Mini-WSB marking card; white; 10 strips with 10 markers/card; 5 mm wide markers

plain	248-501	5
-------	---------	---

1-Conductor/1-Conductor Pin Disconnect Carrier Terminal Blocks X-COM®-SYSTEM; with Two Jumper Positions Assembly Types

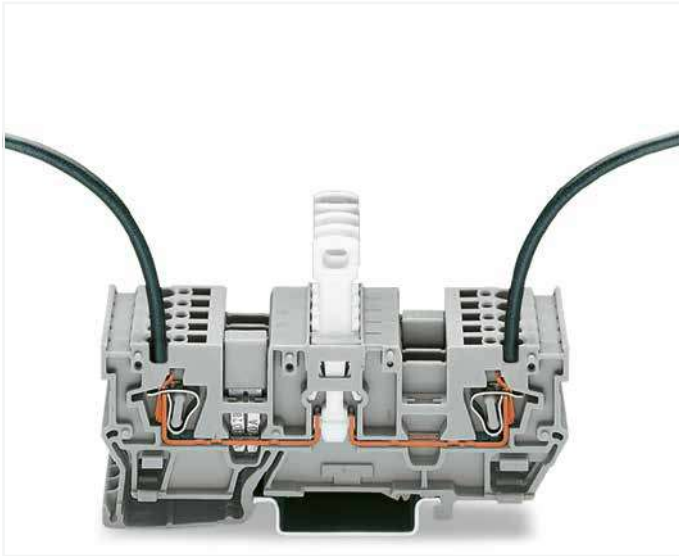

Carrier terminal blocks can be commoned via 280 and 780 Series Jumpers and tested using a test plug adapter (280-4..).

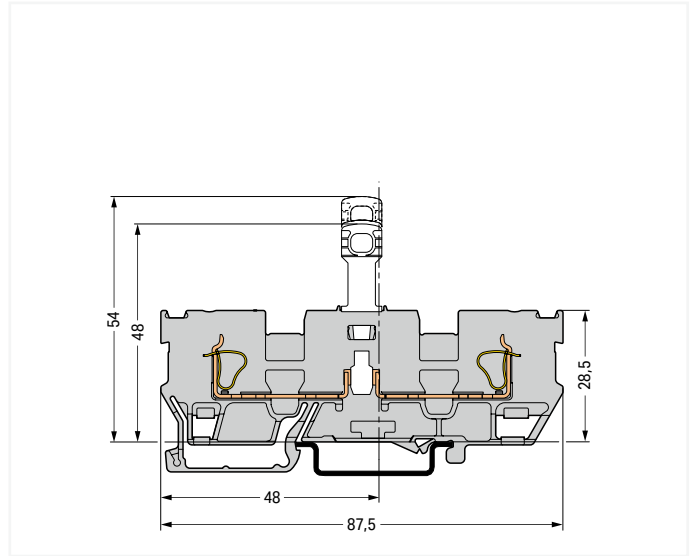

Disconnect carrier terminal block

1-Conductor/1-Pin Carrier Terminal Block and Carrier Terminal Block X-COM®-SYSTEM; for Pluggable Module (Fuses, Relays, Optocouplers, etc.) 4 mm²; 769 Series

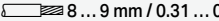
Technical Data	
0.08 ... 4 mm ²	28 ... 12 AWG
400 V / 6 kV / 3 ①	300 V, 20 A ②
I _N 16 A ②	300 V, 20 A ②
Terminal block width: 5 mm / 0.197 inch	
 8 ... 9 mm / 0.31 ... 0.35 inch	

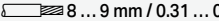
Technical Data	
0.08 ... 4 mm ²	28 ... 12 AWG
400 V / 6 kV / 3 ①	300 V, 20 A ②
I _N 16 A ②	300 V, 20 A ②
 8 ... 9 mm / 0.31 ... 0.35 inch	

① 400 V = rated voltage
6 kV = rated impulse voltage
3 = pollution degree
(see Section 15)

② 16 A, 85°C upper temperature limit, current-carrying capacity curves upon request

Note: 2-conductor female plugs cannot be used.

Please observe the application notes:
Insulation stop, page 425
Jumpers, from page 426
Testing accessories, from page 422
Mini-WSB marking system, page 684

Approvals and corresponding ratings, visit www.wago.com

Accessories; 769 Series

Appropriate marking systems:
Mini-WSB/Mini-WSB Inline

Test plug adapter; 5 mm wide; for 1.5 ... 4 mm² terminal blocks

	gray	280-404	100 (25)
---	------	---------	----------

1-connector female plug; straight

	gray	769-101	200
---	------	---------	-----

Mini-WSB Inline, plain; 1,700 WMB markers (5 mm)/reel; 5 ... 5.2 mm stretchable

	white	2009-145	1
---	-------	----------	---

Mini-WSB marking card; white; 10 strips with 10 markers/card; 5 mm wide markers

	plain	248-501	5
---	-------	---------	---

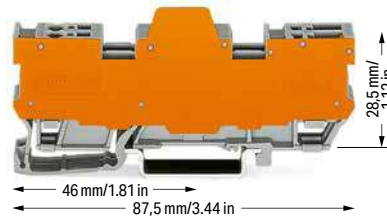
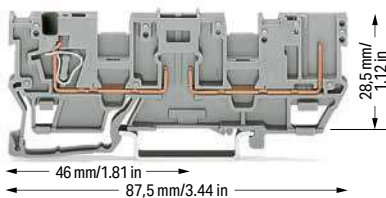

1-conductor/1-pin carrier terminal block; with two jumper positions; gray

	Item No.	Pack. Unit
○ 2-pole	769-181	50

1-conductor/1-pin terminal block for pluggable modules; with two jumper positions; with orange separator plate; gray

	Item No.	Pack. Unit
○ 4-pole; 11.1 mm wide	769-182/769-314	10
○ 6-pole; 16.1 mm wide	769-183/769-314	5
○ 8-pole; 21.1 mm wide	769-184/769-314	5
○ 10-pole; 26.1 mm wide	769-185/769-314	5

Accessories; 769 Series

Appropriate marking systems: Mini-WSB/Mini-WSB Inline

End and intermediate plate; 1.1 mm thick

	orange	769-312	100 (25)
	gray	769-311	100 (25)

Separator; oversized; 1.1 mm thick

	orange	769-314	100 (25)
--	--------	---------	----------

Insulation stop; 0.08 ... 0.2 mm² "s" (0.14 mm² "f-st"); 5 pcs/strip

	white	769-470	200 (25)
---	-------	---------	----------

Insulation stop; 0.25 ... 0.5 mm²; 5 pcs/strip

	light gray	769-471	200 (25)
---	------------	---------	----------

Insulation stop; 0.75 ... 1 mm²; 5 pcs/strip

	dark gray	769-472	200 (25)
---	-----------	---------	----------

Protective warning marker; with black high-voltage symbol; for 5 terminal blocks

	yellow	280-415	100 (25)
---	--------	---------	----------

Coding pin; for coding female plugs

	orange	769-435	100 (25)
---	--------	---------	----------

Adjacent jumper; insulated; I_N = I_N terminal block

	gray	280-402	200 (25)
---	------	---------	----------

Alternate jumper; insulated; I_N = I_N terminal block

	gray	280-409	100 (25)
---	------	---------	----------

Staggered jumper; insulated; 5 mm wide; I_N 24 A

	1 to 2	780-452	100 (25)
	1 to 3	780-453	100 (25)
	1 to 4	780-454	100 (25)
	1 to 5	780-455	50 (25)
	1 to 6	780-456	50 (25)
	1 to 7	780-457	50 (25)
	1 to 8	780-458	50 (25)

Push-in type wire jumper; insulated; 0.75 mm² conductor cross section; I_N 9 A

	L = 60 mm	249-125	100 (10)
	L = 110 mm	249-126	100 (10)
	L = 250 mm	249-127	100 (10)

Test plug module; snaps together; 5 mm wide

	gray	280-418	100 (25)
---	------	---------	----------

Spacer module; snaps together; 5 mm wide

	gray	280-419	100 (25)
---	------	---------	----------

Test plug; with 500 mm cable; 2 mm Ø; max. 42 V

	red	210-136	50
---	-----	---------	----

1-Conductor Female Plugs and Selection of Pluggable Modules X-COM®-SYSTEM Assembly Types

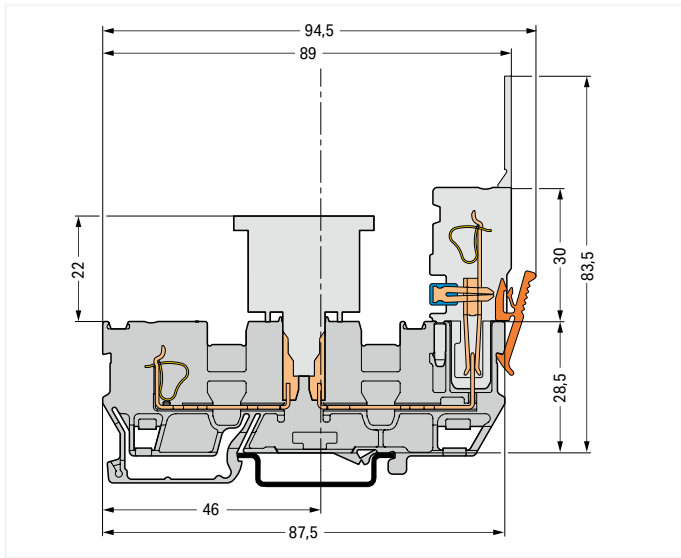

Carrier terminal block

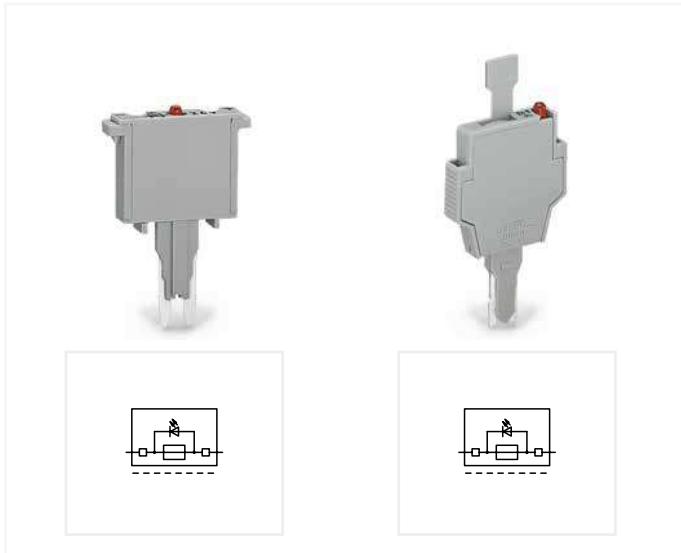

Selection of pluggable modules

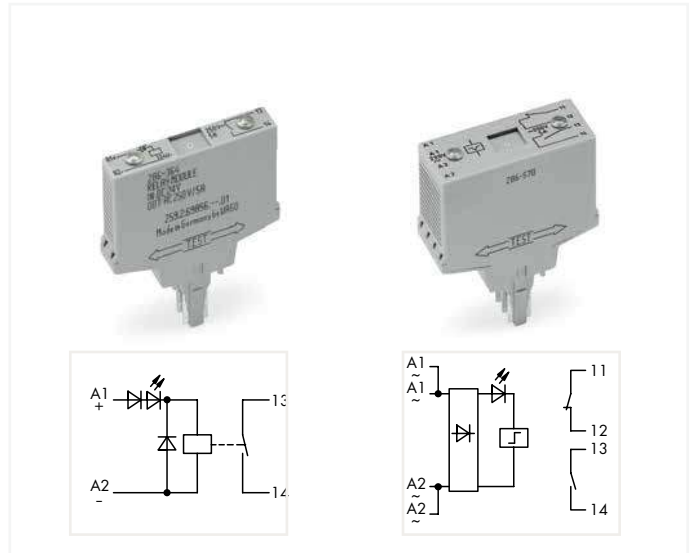

Selection of pluggable modules

2-Pin Carrier Terminal Block and Carrier Terminal Block X-COM®-SYSTEM; for Pluggable Module (Fuses, Relays, Optocouplers, etc.) 769 Series

Technical Data

400 V / 6 kV / 3 ①	300 V, 20 A ②
I _N 16 A ②	300 V, 20 A ②
Terminal block width: 5 mm / 0.197 inch	

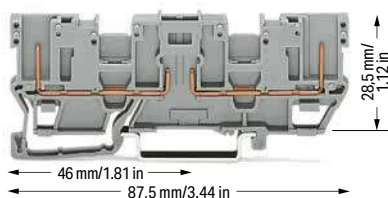

2-pin carrier terminal block; with two jumper positions; gray

	Item No.	Pack. Unit
○ 2-pole	769-161	50

Technical Data

400 V / 6 kV / 3 ①	300 V, 20 A ②
I _N 16 A ②	300 V, 20 A ②

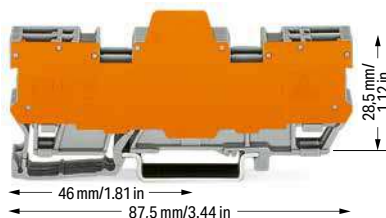

2-pin terminal block for pluggable modules; with two jumper positions; with orange separator plate; gray

	Item No.	Pack. Unit
○ 4-pole; 11.1 mm wide	769-162/769-313	10
○ 6-pole; 16.1 mm wide	769-163/769-313	5
○ 8-pole; 21.1 mm wide	769-164/769-313	5
○ 10-pole; 26.1 mm wide	769-165/769-313	5

- ① 400 V = rated voltage
6 kV = rated impulse voltage
3 = pollution degree
(see Section 15)

- ② 16 A, 85°C upper temperature limit, current-carrying capacity curves upon request

Note: 2-conductor female plugs cannot be used.

Please observe the application notes:
Jumpers, from page 426
Mini-WSB marking system, page 684

Approvals and corresponding ratings,
visit www.wago.com

7

Accessories; 769 Series

Appropriate marking systems: Mini-WSB/Mini-WSB Inline

End and intermediate plate; 1.1 mm thick

orange	769-310	100 (25)
gray	769-309	100 (25)

Separator; oversized; 1.1 mm thick

orange	769-313	100 (25)
--------	---------	----------

Coding pin; for coding female plugs

orange	769-435	100 (25)
--------	---------	----------

Adjacent jumper; insulated; I_N = I_N terminal block

gray	280-402	200 (25)
------	---------	----------

Alternate jumper; insulated; I_N = I_N terminal block

gray	280-409	100 (25)
------	---------	----------

Staggered jumper; insulated; 5 mm wide; I_N 24 A

1 to 2	780-452	100 (25)
1 to 3	780-453	100 (25)
1 to 4	780-454	100 (25)
1 to 5	780-455	50 (25)
1 to 6	780-456	50 (25)
1 to 7	780-457	50 (25)
1 to 8	780-458	50 (25)

Push-in type wire jumper; insulated; 0.75 mm² conductor cross section; I_N 9 A

L = 60 mm	249-125	100 (10)
L = 110 mm	249-126	100 (10)
L = 250 mm	249-127	100 (10)

1-conductor female plug; straight

gray	769-101	200
------	---------	-----

1-conductor female plug; angled

gray	769-101/022-000	200
------	-----------------	-----

Mini-WSB Inline, plain; 1,700 WMB markers (5 mm)/reel; 5 ... 5.2 mm stretchable

white	2009-145	1
-------	----------	---

Mini-WSB marking card; white; 10 strips with 10 markers/card; 5 mm wide markers

plain	248-501	5
-------	---------	---

1-Conductor Female Plugs and Selection of Pluggable Modules X-COM®-SYSTEM Assembly Types

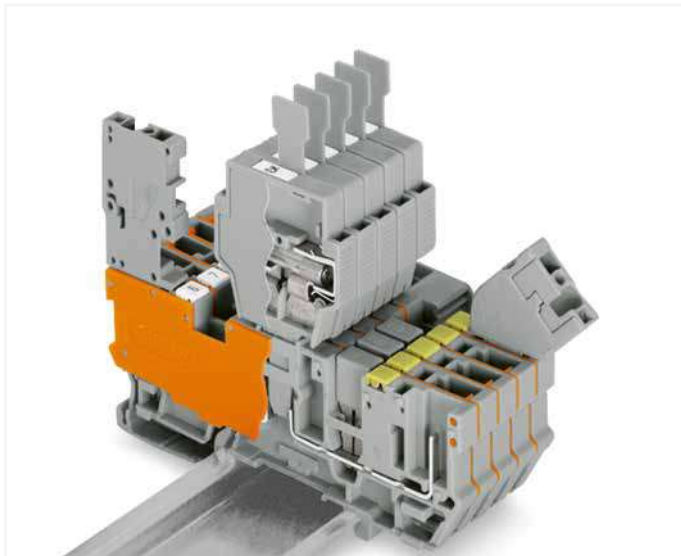

With 6 mm wide fuse plugs, only 1-pole female plugs can be used. Commoning is only possible using adjacent jumpers (280 Series) and push-in type wire jumpers.

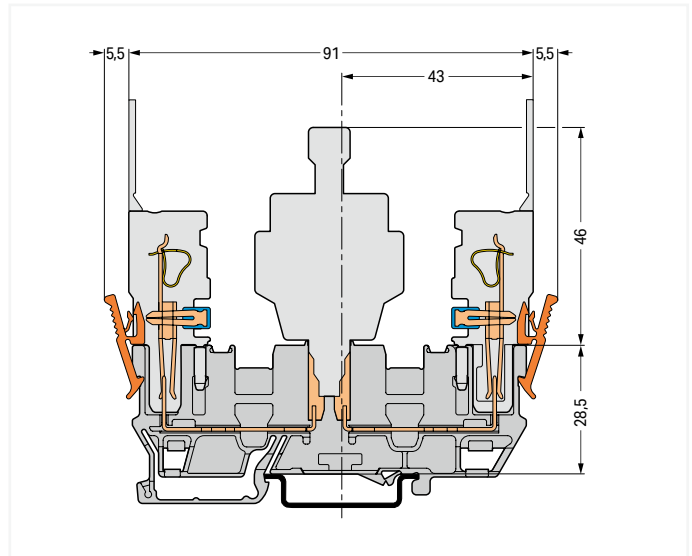

Carrier terminal block
For other dimensions, see carrier terminal block (769-151).



2-pin terminal block for pluggable modules; with orange separator plate

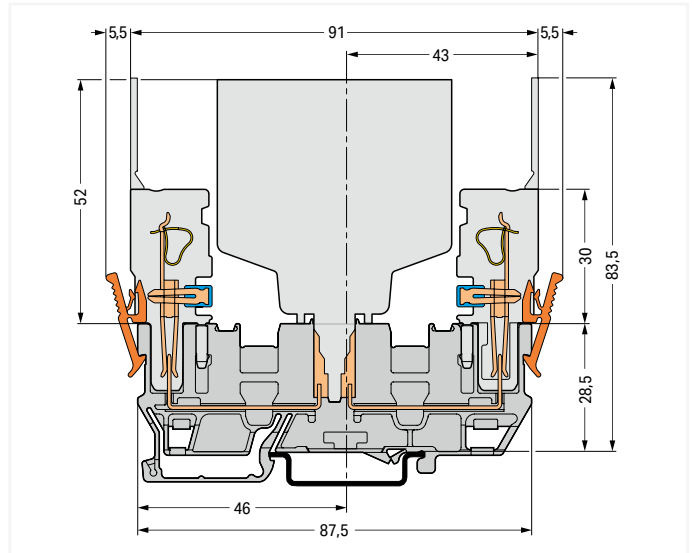

Carrier terminal block

7

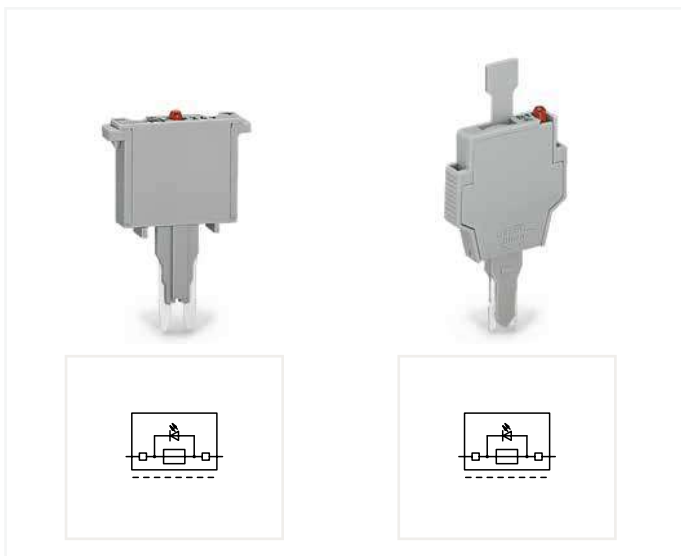

Selection of pluggable modules

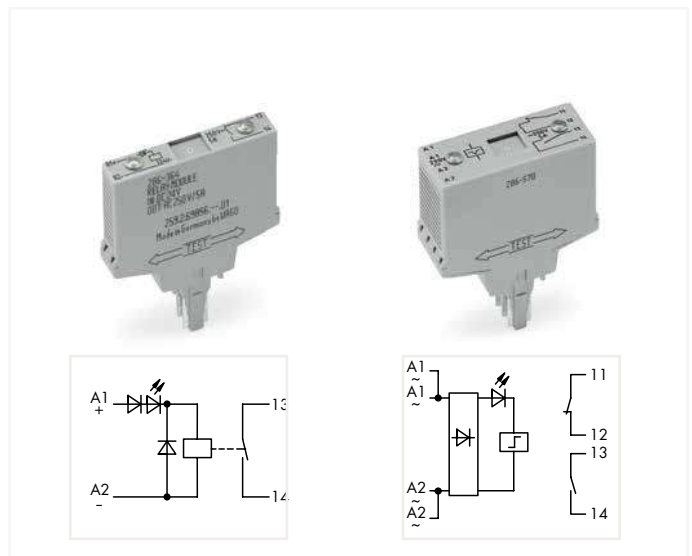

Selection of pluggable modules

CAGE CLAMP®

1-Conductor/1-Conductor Carrier Terminal Block and Carrier Terminal Block X-COM®-SYSTEM; for Pluggable Module (Fuses, Relays, Optocouplers, etc.) 4 mm²; 769 Series

Technical Data

0.08 ... 4 mm ²	28 ... 12 AWG
400 V / 6 kV / 3 ①	300 V, 20 A ②
I _N 16 A ②	300 V, 20 A ②

Terminal block width: 5 mm / 0.197 inch

 8 ... 9 mm / 0.31 ... 0.35 inch

Technical Data

0.08 ... 4 mm ²	28 ... 12 AWG
400 V / 6 kV / 3 ①	300 V, 20 A ②
I _N 16 A ②	300 V, 20 A ②

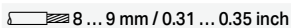
 8 ... 9 mm / 0.31 ... 0.35 inch

- ① 400 V = rated voltage
6 kV = rated impulse voltage
3 = pollution degree
(see Section 15)

- ② 16 A, 85°C upper temperature limit, current-carrying capacity curves upon request

Please observe the application notes:
Insulation stop, page 425
Jumpers, from page 426
Testing accessories, from page 422
Mini-WSB marking system, page 684

Approvals and corresponding ratings,
visit www.wago.com

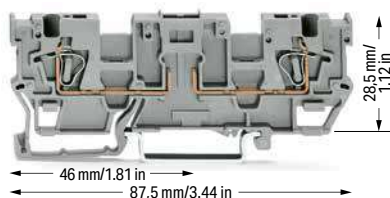

1-conductor/1-conductor carrier terminal block; with two jumper positions; gray

	Item No.	Pack. Unit
○ 2-pole	769-191	50

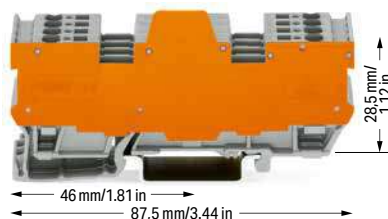

1-conductor/1-conductor terminal block for pluggable modules; with two jumper positions; with orange separator plate; gray

	Item No.	Pack. Unit
○ 4-pole; 11.1 mm wide	769-192/769-319	10
○ 6-pole; 16.1 mm wide	769-193/769-319	5
○ 8-pole; 21.1 mm wide	769-194/769-319	5
○ 10-pole; 26.1 mm wide	769-195/769-319	5

Accessories; 769 Series

Appropriate marking systems: Mini-WSB/Mini-WSB Inline

End and intermediate plate; 1.1 mm thick

 orange	769-318	100 (25)
 gray	769-317	100 (25)

Separator; oversized; 1.1 mm thick

 orange	769-319	100 (25)
---	---------	----------

Insulation stop; 0.08 ... 0.2 mm² "s" (0.14 mm² "f-st"); 5 pcs/strip

 white	769-470	200 (25)
--	---------	----------

Insulation stop; 0.25 ... 0.5 mm²; 5 pcs/strip

 light gray	769-471	200 (25)
---	---------	----------

Insulation stop; 0.75 ... 1 mm²; 5 pcs/strip

 dark gray	769-472	200 (25)
--	---------	----------

Protective warning marker; with black high-voltage symbol; for 5 terminal blocks

 yellow	280-415	100 (25)
---	---------	----------

Adjacent jumper; insulated; I_N = I_N terminal block

 gray	280-402	200 (25)
---	---------	----------

Alternate jumper; insulated; I_N = I_N terminal block

 gray	280-409	100 (25)
---	---------	----------

Staggered jumper; insulated; 5 mm wide; I_N 24 A

 1 to 2	780-452	100 (25)
1 to 3	780-453	100 (25)
1 to 4	780-454	100 (25)
1 to 5	780-455	50 (25)
1 to 6	780-456	50 (25)
1 to 7	780-457	50 (25)
1 to 8	780-458	50 (25)

Push-in type wire jumper; insulated; 0.75 mm² conductor cross section; I_N 9 A

 L = 60 mm	249-125	100 (10)
L = 110 mm	249-126	100 (10)
L = 250 mm	249-127	100 (10)

Test plug; with 500 mm cable; 2 mm Ø; max. 42 V

 red	210-136	50
---	---------	----

Mini-WSB Inline, plain; 1,700 WMB markers (5 mm)/reel; 5 ... 5.2 mm stretchable

 white	2009-145	1
---	----------	---

Mini-WSB marking card; white; 10 strips with 10 markers/card; 5 mm wide markers

 plain	248-501	6
---	---------	---

Selection of Pluggable Modules Assembly Types

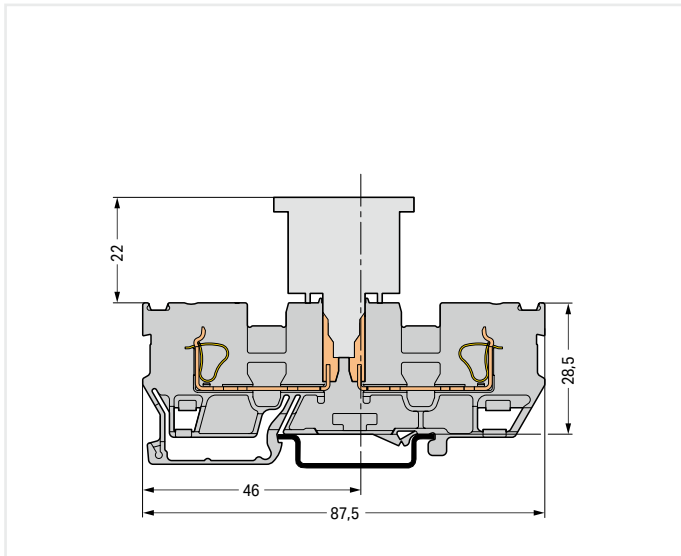

Carrier terminal block

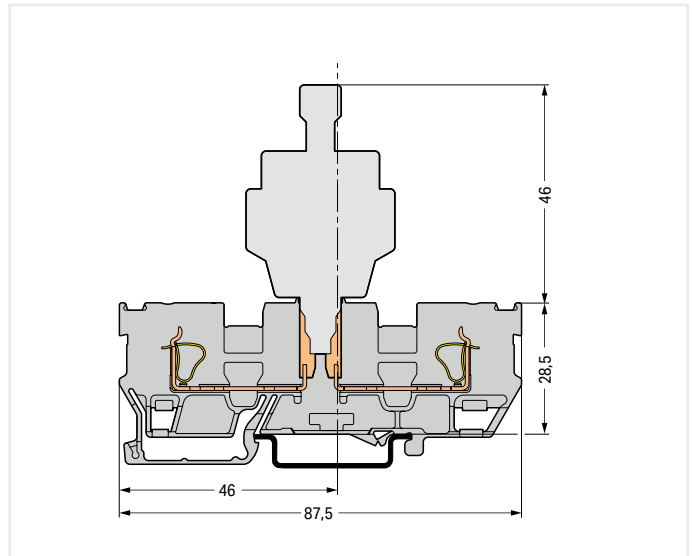

Carrier terminal block

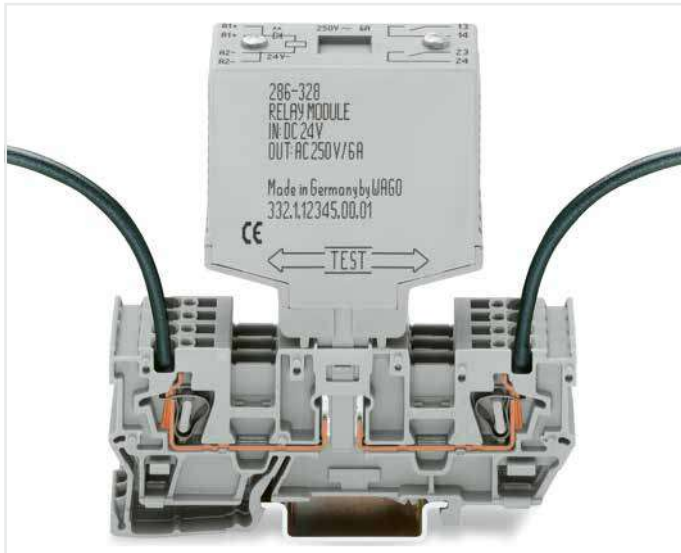

1-conductor/1-conductor carrier terminal block; with two jumper positions

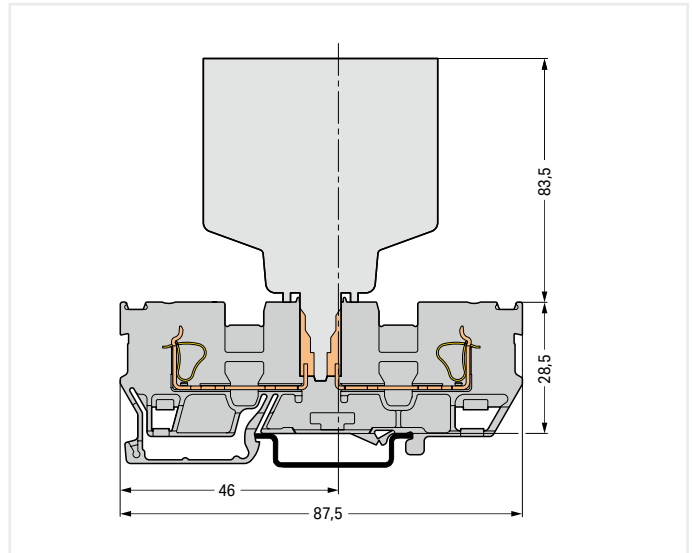

Carrier terminal block

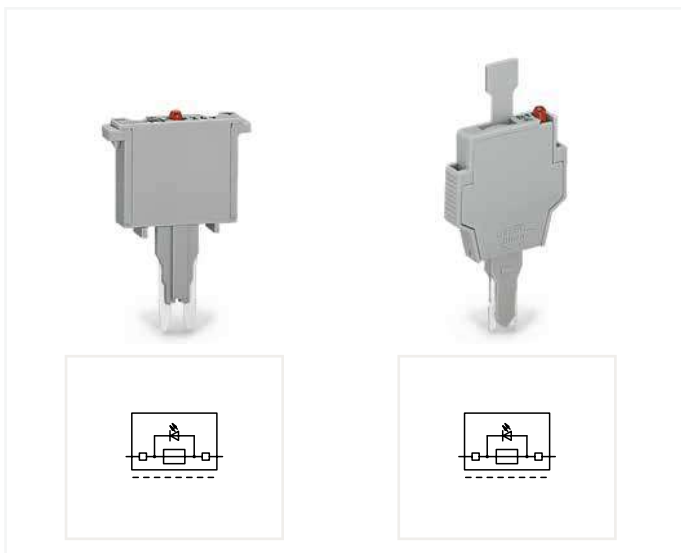

Selection of pluggable modules

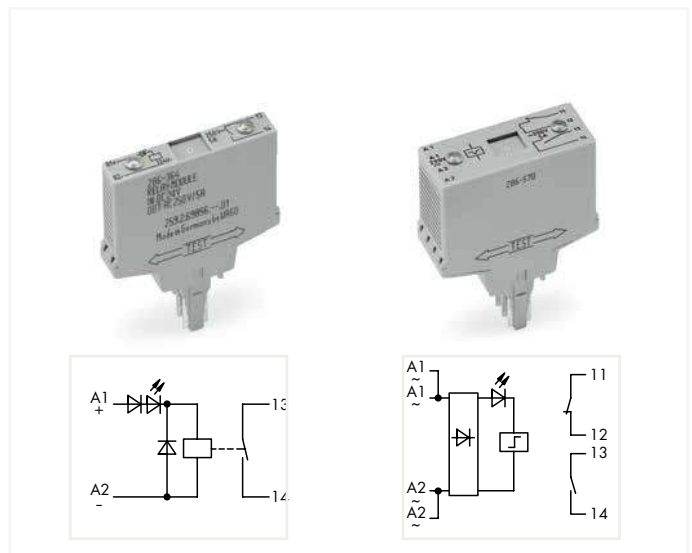

Selection of pluggable modules

7

Fuse Plugs, Pluggable Diode and LED Modules



Fuse plug; with soldered miniature fuse; 5 mm wide; gray
Electrical ratings are given by the fuse.

	Item No.	Pack. Unit
	250 mA FF 280-850	100
	500 mA FF 280-852	100
	1 A FF 280-854	100
	2 A FF 280-856	100

Diode module; with 1N4007 diode; 5 mm wide

	Item No.	Pack. Unit
	gray 280-801/281-411	100

LED module; with red LED; 5 mm wide; I_N 5.6 mA; I_F 25 mA; gray

	Item No.	Pack. Unit
	24 VDC 280-801/281-413	100
	48 VDC 280-801/281-414	100

Fuse plug; with soldered miniature fuse; with additional indicator lamp; red LED; 15 ... 30 VDC; 5 mm wide; gray
Electrical ratings are given by the fuse and blown fuse indication. Leakage current in case of a blown fuse: LED 5 ... 20 mA

	250 mA FF 280-850/281-413	100
	500 mA FF 280-852/281-413	100
	1 A FF 280-854/281-413	100
	2 A FF 280-856/281-413	100

Diode module; with 1N4007 recovery diode; red LED; 5 mm wide; gray

	24 VDC 280-801/281-420	100
	48 VDC 280-801/281-421	100

LED module; with red LED; 5 mm wide; I_N 5.6 mA; I_F 25 mA; gray

	24 VAC/DC 280-801/281-415	100
	48 VAC/VDC 280-801/281-416	100

Fuse plug with pull-tab; for 5 x 20 mm and 5 x 25 mm glass cartridge fuses; 6 mm wide
Electrical ratings are given by the fuse.

	281-511	50
--	---------	----

Fuse plug with pull-tab; for 5 x 20 mm and 5 x 25 mm glass cartridge fuses; with hole for one LED (for self-assembly); 6 mm wide; gray
Electrical ratings are given by the fuse and blown fuse indication.

	281-512	50
--	---------	----

Fuse plug with pull-tab; for 5 x 20 mm and 5 x 25 mm glass cartridge fuses; with LED; 24 VAC/DC; 6 mm wide
Electrical ratings are given by the fuse and blown fuse indication. Leakage current in case of a blown fuse: LED 5 ... 20 mA

	281-512/281-501	50
--	-----------------	----

Fuse plug with pull-tab; for 5 x 20 mm and 5 x 25 mm glass cartridge fuses; with neon lamp; 120 VAC/DC; 6 mm wide
Electrical ratings are given by the fuse and blown fuse indication. Leakage current in case of a blown fuse: Neon lamp < 0.4 mA

	281-512/281-418	50
	281-512/281-417	50

Neon indicator module; 5 mm wide; I_N 0.5 mA; gray

	120 VAC/VDC 280-801/281-418	100
	230 VAC/VDC 280-801/281-417	100

1-Conductor/1-Pin Double-Deck Carrier Terminal Block X-COM®-SYSTEM

2.5 (4 "f-st") mm²; 870 Series

Technical Data	
0.08 ... 2.5 (4 "f-st") mm ² ①	28 ... 12 AWG
500 V / 6 kV / 3 ②	300 V, 20 A I_N
I_N 16 A	
Terminal block width: 5 mm / 0.197 inch	
6 ... 7 mm / 0.24 ... 0.28 inch	

Technical Data	
0.08 ... 2.5 (4 "f-st") mm ² ①	28 ... 12 AWG
500 V / 6 kV / 3 ②	
I_N 16 A	
Terminal block width: 5 mm / 0.197 inch	
6 ... 7 mm / 0.24 ... 0.28 inch	

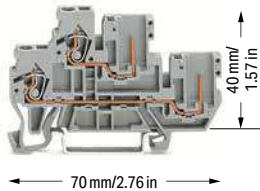

1-conductor/1-pin double-deck carrier terminal block; through/through terminal block; gray

	Item No.	Pack. Unit
○ L/L	870-101	50
○ N/L	870-102	50
○ L/N	870-103	50

1-conductor/1-pin double-deck carrier terminal block; through/through terminal block; blue

● N/N	870-104	50
-------	---------	----

Other terminal blocks with the same profile:

Through	870-501	Page 432
---------	---------	----------

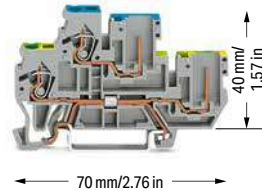

1-conductor/1-pin double-deck carrier terminal block; ground conductor/through terminal block; gray

	Item No.	Pack. Unit
○ PE/N	870-117	50
○ PE/L	870-127	50

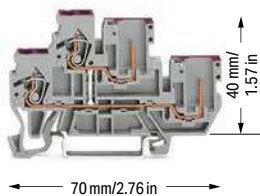

2-conductor/2-pin double-deck carrier terminal block; 2-conductor/2-pin through terminal block; internally commoned; Violet conductor entry; gray

	Item No.	Pack. Unit
○ L	870-108	50

2-conductor/2-pin double-deck carrier terminal block; 2-conductor/2-pin through terminal block; internally commoned; Violet conductor entry; blue

● N	870-109	50
-----	---------	----

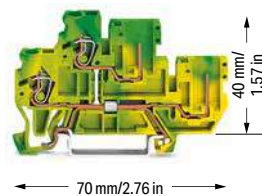

2-conductor/2-pin double-deck carrier block; 2-conductor/2-pin ground conductor block; internally commoned; green-yellow

	Item No.	Pack. Unit
● PE	870-107	50

- ① Max. insulation diameter: 4.4 mm
- ② 500 V = rated voltage
6 kV = rated impulse voltage
3 = pollution degree (see Section 15)

Note: 2-conductor female plugs cannot be used.

Please observe the application notes:
Insulation stop, page 425
Marking, from page 684

Approvals and corresponding ratings, visit www.wago.com

Accessories; 870 Series

Appropriate marking systems:
Mini-WSB/Mini-WSB Inline/WMB/WMB Inline

End and intermediate plate; 1 mm thick

 orange	870-119	100 (25)
 gray	870-118	100 (25)

Insulation stop; 0.08 ... 0.2 mm² "s" (0.14 mm² "f-st"); 5 pcs/strip

 white	280-470	200 (25)
---	---------	----------

Insulation stop; 0.25 ... 0.5 mm²; 5 pcs/strip

 light gray	280-471	200 (25)
--	---------	----------

Insulation stop; 0.75 ... 1 mm²; 5 pcs/strip

 dark gray	280-472	200 (25)
---	---------	----------

Coding pin; for coding female plugs

 orange	769-435	100 (25)
--	---------	----------

Push-in type jumper bar; insulated; I_N 18 A; light gray

 2-way	870-402	200 (25)
3-way	870-403	200 (25)
4-way	870-404	100 (25)
5-way	870-405	100 (25)
6-way	870-406	100 (25)
7-way	870-407	100 (25)
8-way	870-408	100 (25)
9-way	870-409	100 (25)
10-way	870-410	50 (25)

Push-in type jumper bar; insulated; I_N 18 A; light gray

 1 to 3	870-433	200 (25)
1 to 4	870-434	200 (25)
1 to 5	870-435	100 (25)
1 to 6	870-436	100 (25)
1 to 7	870-437	100 (25)
1 to 8	870-438	100 (25)
1 to 9	870-439	100 (25)
1 to 10	870-440	50 (25)

Pin cover; with Mini-WSB marker slot

 gray	769-438	100 (25)
orange	769-439	100 (25)

1-connector female plug; straight

 gray	769-101	200
--	---------	-----

1-conductor female plug; angled

 gray	769-101/022-000	200
--	-----------------	-----

7

1-Conductor/1-Pin Double-Deck Carrier Terminal Blocks and 1-/2-Conductor Female Plugs X-COM®-SYSTEM Assembly Types



Commoning a double-deck through terminal block (870-501) with a 1-conductor/1-pin double-deck terminal block (870-101) via push-in type jumper bar.

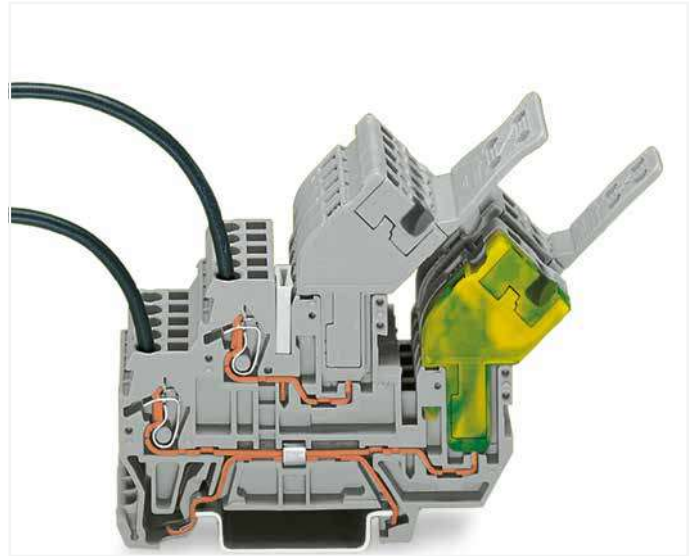

1-conductor female plug; angled
Double-deck carrier terminal blocks can be commoned via 870 Series Push-In Type Jumper Bars.

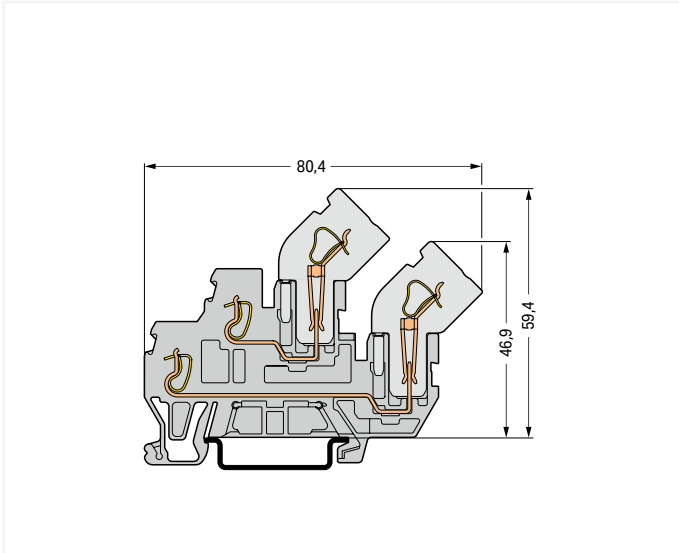

Carrier terminal block

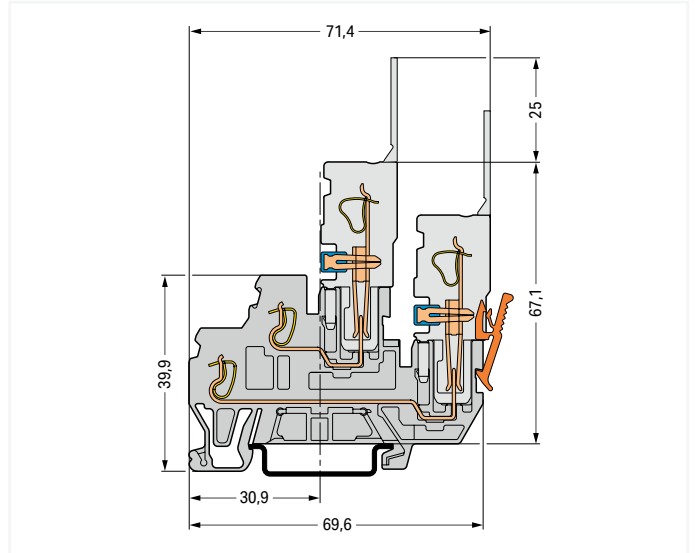

Carrier terminal block

2-Conductor/1-Pin Double-Deck Carrier Terminal Block X-COM®-SYSTEM

2.5 (4 "f-st") mm²; 870 Series

Technical Data

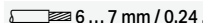
0.08 ... 2.5 (4 "f-st") mm² ① | 28 ... 12 AWG
 500 V / 6 kV / 3 ② | 300 V, 20 A I_N
 I_N 16 A
 Terminal block width: 5 mm / 0.197 inch
 6 ... 7 mm / 0.24 ... 0.28 inch

Technical Data

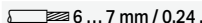
0.08 ... 2.5 (4 "f-st") mm² ① | 28 ... 12 AWG
 Terminal block width: 5 mm / 0.197 inch
 6 ... 7 mm / 0.24 ... 0.28 inch

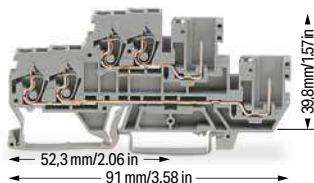

2-conductor/1-pin double-deck carrier terminal block; through/through terminal block; gray

	Item No.	Pack. Unit
<input type="radio"/> L/L	870-1131	40

4-conductor/2-pin double-deck carrier terminal block; 2-conductor/2-pin through terminal block; internally commoned; Violet conductor entry; gray

<input type="radio"/> L	870-1138	40
-------------------------	----------	----

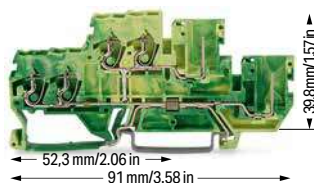

4-conductor/2-pin double-deck carrier block; 4-conductor/2-pin ground conductor block; internally commoned; green-yellow

	Item No.	Pack. Unit
<input type="radio"/> PE/N	870-1137	40

① Max. insulation diameter: 4.4 mm

② 500 V = rated voltage
 6 kV = rated impulse voltage
 3 = pollution degree
 (see Section 15)

Note: 2-conductor female plugs cannot be used.



Please observe the application notes:
 Insulation stop, page 425
 Marking, from page 684

Approvals and corresponding ratings,
 visit www.wago.com

Accessories; 870 Series

Appropriate marking systems:
 Mini-WSB/Mini-WSB Inline/WMB/WMB Inline

End and intermediate plate; 1 mm thick

	orange	870-1149	100 (25)
	gray	870-1148	100 (25)

Insulation stop; 0.08 ... 0.2 mm² "s" (0.14 mm² "f-st"); 5 pcs/strip

	white	280-470	200 (25)
---	-------	---------	----------

Insulation stop; 0.25 ... 0.5 mm²; 5 pcs/strip

	light gray	280-471	200 (25)
---	------------	---------	----------

Insulation stop; 0.75 ... 1 mm²; 5 pcs/strip

	dark gray	280-472	200 (25)
---	-----------	---------	----------

Coding pin; for coding female plugs

	orange	769-435	100 (25)
---	--------	---------	----------

Push-in type jumper bar; insulated; I_N 18 A; light gray

	2-way	870-402	200 (25)
	3-way	870-403	200 (25)
	4-way	870-404	100 (25)
	5-way	870-405	100 (25)
	6-way	870-406	100 (25)
	7-way	870-407	100 (25)
	8-way	870-408	100 (25)
	9-way	870-409	100 (25)
	10-way	870-410	50 (25)

Push-in type jumper bar; insulated; I_N 18 A; light gray

	1 to 3	870-433	200 (25)
	1 to 4	870-434	200 (25)
	1 to 5	870-435	100 (25)
	1 to 6	870-436	100 (25)
	1 to 7	870-437	100 (25)
	1 to 8	870-438	100 (25)
	1 to 9	870-439	100 (25)
	1 to 10	870-440	50 (25)

Pin cover; with Mini-WSB marker slot

	gray	769-438	100 (25)
	orange	769-439	100 (25)

1-conductor female plug; straight

	gray	769-101	200
---	------	---------	-----

1-conductor female plug; angled

	gray	769-101/022-000	200
---	------	-----------------	-----

2-Pin/2-Pin Double-Deck Carrier Terminal Block X-COM®-SYSTEM 870 Series

Technical Data

500 V / 6 kV / 3 ① | 300 V, 20 A I_{Nmax}

I_N 16 A

Terminal block width: 5 mm / 0.197 inch

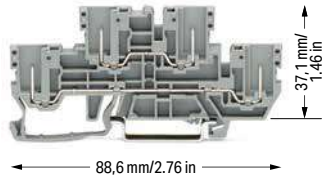

2-pin/2-pin double-deck carrier terminal block; through/through terminal block; gray

	Item No.	Pack. Unit
○ L/L	870-151	50

Technical Data

Terminal block width: 5 mm / 0.197 inch

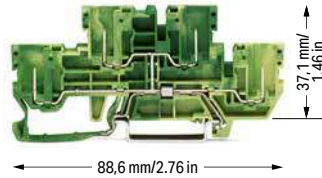

4-pin double-deck carrier block; 4-pin ground conductor block; internally commoned; green-yellow

	Item No.	Pack. Unit
● PE	870-157	50

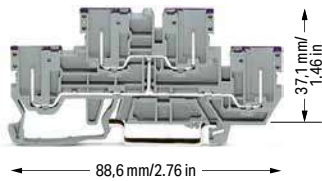

4-pin double-deck carrier terminal block; 4-pin through terminal block; internally commoned; Violet conductor entry; gray

	Item No.	Pack. Unit
○ L	870-158	50

① 500 V = rated voltage

6 kV = rated impulse voltage

3 = pollution degree

(see Section 15)

Note: 2-conductor female plugs cannot be used.

Approvals and corresponding ratings, visit www.wago.com

Accessories; 870 Series

Appropriate marking systems:

Mini-WSB/Mini-WSB Inline/WMB/WMB Inline

End and intermediate plate; 1 mm thick

	orange	870-169	100 (25)
	gray	870-168	100 (25)

Coding pin; for coding female plugs

	orange	769-435	100 (25)
--	--------	---------	----------

Push-in type jumper bar; insulated; I_N 18 A; light gray

	2-way	870-402	200 (25)
	3-way	870-403	200 (25)
	4-way	870-404	100 (25)
	5-way	870-405	100 (25)
	6-way	870-406	100 (25)
	7-way	870-407	100 (25)
	8-way	870-408	100 (25)
	9-way	870-409	100 (25)
	10-way	870-410	50 (25)

Push-in type jumper bar; insulated; I_N 18 A; light gray

	1 to 3	870-433	200 (25)
	1 to 4	870-434	200 (25)
	1 to 5	870-435	100 (25)
	1 to 6	870-436	100 (25)
	1 to 7	870-437	100 (25)
	1 to 8	870-438	100 (25)
	1 to 9	870-439	100 (25)
	1 to 10	870-440	50 (25)

Pin cover; with Mini-WSB marker slot

	gray	769-438	100 (25)
	orange	769-439	100 (25)

1-conductor female plug; straight

	gray	769-101	200
--	------	---------	-----

1-conductor female plug; angled

	gray	769-101/022-000	200
--	------	-----------------	-----

Mini-WSB Inline, plain; 1,700 WMB markers (5 mm)/reel; 5 ... 5.2 mm stretchable

	white	2009-145	1
--	-------	----------	---

Mini-WSB marking card; white; 10 strips with 10 markers/card; 5 mm wide markers

	plain	248-501	5
--	-------	---------	---

7

2-Pin/2-Pin Double-Deck Carrier Terminal Blocks and 1-Conductor Female Plugs X-COM®-SYSTEM Assembly Types



1-conductor female plug; straight
Double-deck carrier terminal blocks can be commoned via 870 Series Push-In Type Jumper Bars.
Notice: 2-conductor female plugs cannot be used.

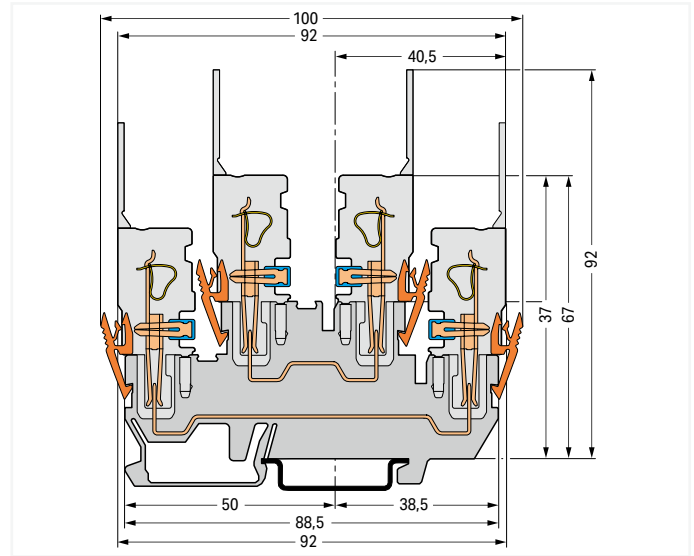

Carrier terminal block

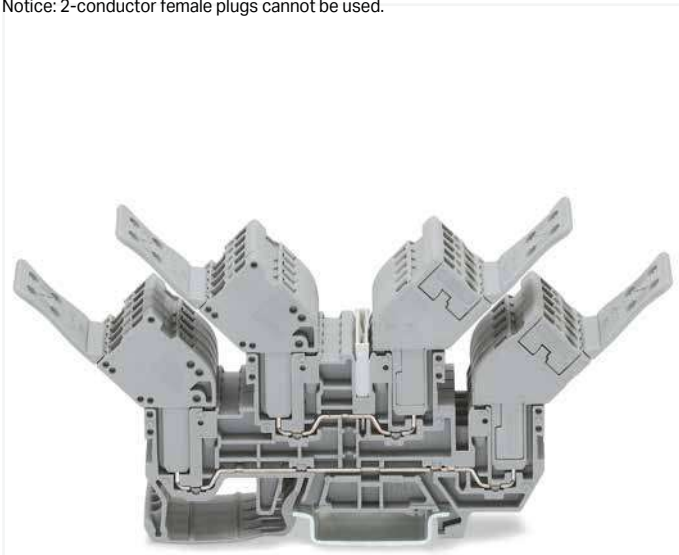

1-conductor female plug; angled
Double-deck carrier terminal blocks can be commoned via 870 Series Push-In Type Jumper Bars.

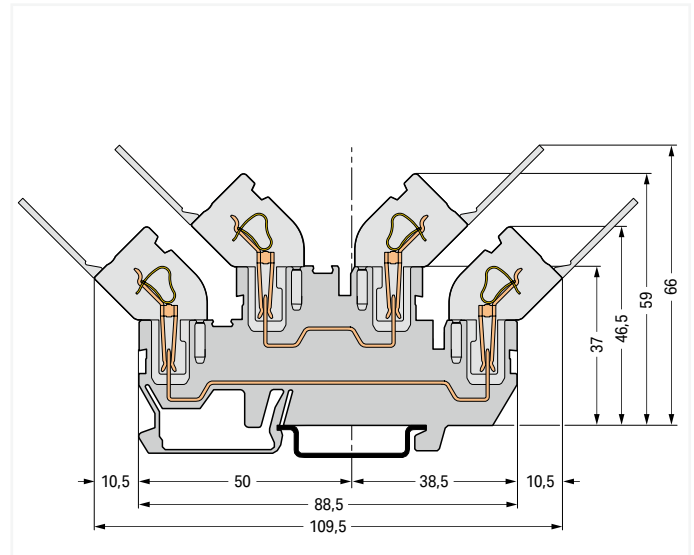

Carrier terminal block

2-Conductor/2-Pin Double-Deck Carrier Terminal Block X-COM®-SYSTEM 2.5 (4 "f-st") mm²; 870 Series

Technical Data

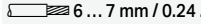
0.08 ... 2.5 (4 "f-st") mm² ① | 28 ... 12 AWG
 500 V / 6 kV / 3 ② | 300 V, 20 A $I_{N, max}$
 I_N 16 A
 Terminal block width: 5 mm / 0.197 inch
 6 ... 7 mm / 0.24 ... 0.28 inch

Technical Data

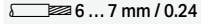
0.08 ... 2.5 (4 "f-st") mm² ① | 28 ... 12 AWG
 Terminal block width: 5 mm / 0.197 inch
 6 ... 7 mm / 0.24 ... 0.28 inch

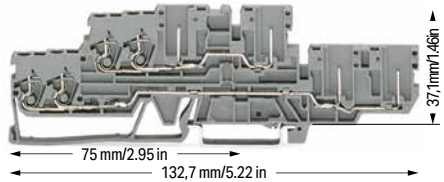

2-conductor/2-pin double-deck carrier terminal block; through/through terminal block; gray

	Item No.	Pack. Unit
○ L/L	870-131	40

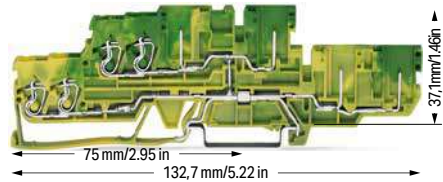

4-conductor/4-pin double-deck carrier block; 4-conductor/4-pin ground conductor block; internally commoned; green-yellow

	Item No.	Pack. Unit
● PE	870-137	40

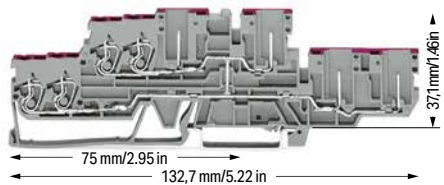

4-conductor/4-pin double-deck carrier terminal block; 4-conductor/4-pin through terminal block; internally commoned; Violet conductor entry; gray

	Item No.	Pack. Unit
○ L	870-138	40

① Max. insulation diameter: 4.4 mm

② 500 V = rated voltage
 6 kV = rated impulse voltage
 3 = pollution degree
 (see Section 15)

Note: 2- and 1-conductor angled female plugs cannot be used.

Please observe the application notes:
 Insulation stop, page 425
 Marking, from page 684

Approvals and corresponding ratings, visit www.wago.com

Accessories; 870 Series

Appropriate marking systems:
 Mini-WSB/Mini-WSB Inline/WMB/WMB Inline

End and intermediate plate; 1 mm thick

	orange	870-149	100 (25)
	gray	870-148	100 (25)

Insulation stop; 0.08 ... 0.2 mm² "s" (0.14 mm² "f-st"); 5 pcs/strip

	white	280-470	200 (25)
---	-------	---------	----------

Insulation stop; 0.25 ... 0.5 mm²; 5 pcs/strip

	light gray	280-471	200 (25)
--	------------	---------	----------

Insulation stop; 0.75 ... 1 mm²; 5 pcs/strip

	dark gray	280-472	200 (25)
---	-----------	---------	----------

Coding pin; for coding female plugs

	orange	769-435	100 (25)
---	--------	---------	----------

Push-in type jumper bar; insulated; I_N 18 A; light gray

	2-way	870-402	200 (25)
	3-way	870-403	200 (25)
	4-way	870-404	100 (25)
	5-way	870-405	100 (25)
	6-way	870-406	100 (25)
	7-way	870-407	100 (25)
	8-way	870-408	100 (25)
	9-way	870-409	100 (25)
	10-way	870-410	50 (25)

Push-in type jumper bar; insulated; I_N 18 A; light gray

	1 to 3	870-433	200 (25)
	1 to 4	870-434	200 (25)
	1 to 5	870-435	100 (25)
	1 to 6	870-436	100 (25)
	1 to 7	870-437	100 (25)
	1 to 8	870-438	100 (25)
	1 to 9	870-439	100 (25)
	1 to 10	870-440	50 (25)

Pin cover; with Mini-WSB marker slot

	gray	769-438	100 (25)
	orange	769-439	100 (25)

1-connector female plug; straight

	gray	769-101	200
---	------	---------	-----

7

2-Conductor/2-Pin Double-Deck Carrier Terminal Blocks and 1-Conductor Female Plugs X-COM®-SYSTEM Assembly Types

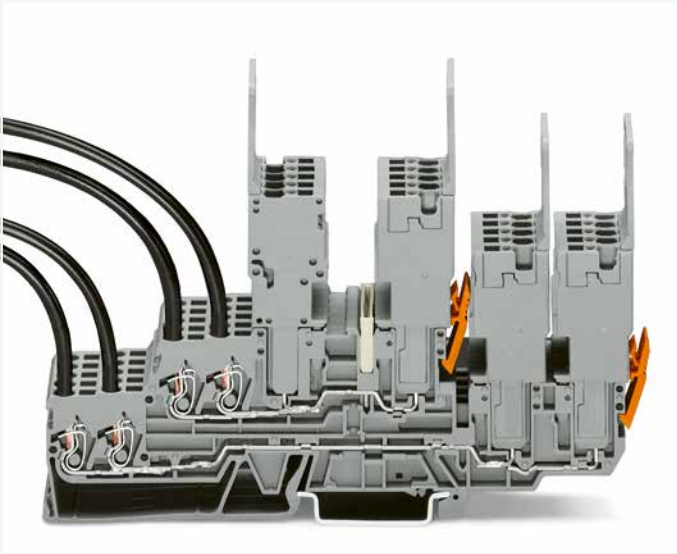

1-conductor female plug; straight

Double-deck carrier terminal blocks can be commoned via 870 Series Push-In Type Jumper Bars.

Notice: Female plugs must be arranged in the opposite direction on the upper deck. 2-conductor female plugs and angled 1-conductor female plugs cannot be used.

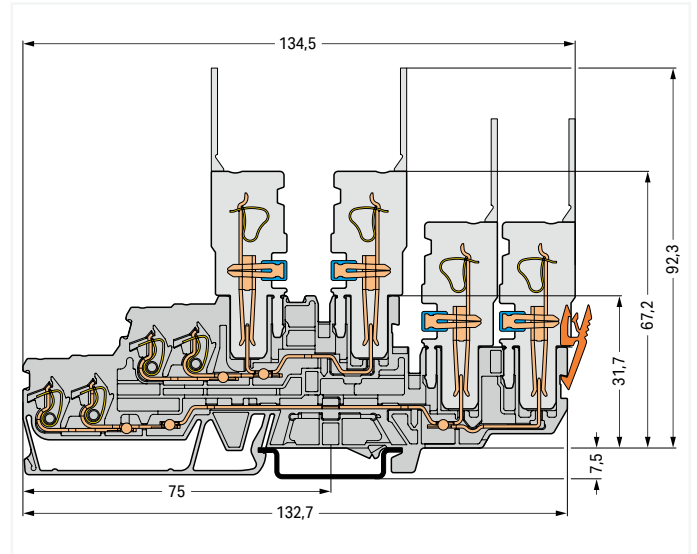

Carrier terminal block

Male Connectors, Headers and Female Plugs X-COM®-SYSTEM

769 Series

Description and Installation



Male connector; with CAGE CLAMP® connection
1-connector female plug; straight

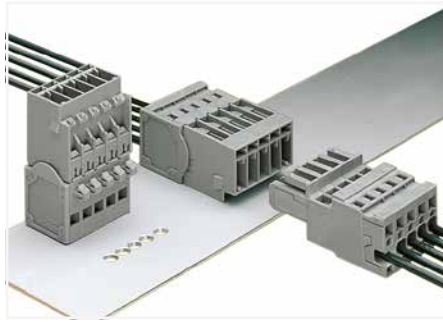

Male connector; with CAGE CLAMP® connection and
snap-in mounting feet
1-connector female plug; straight

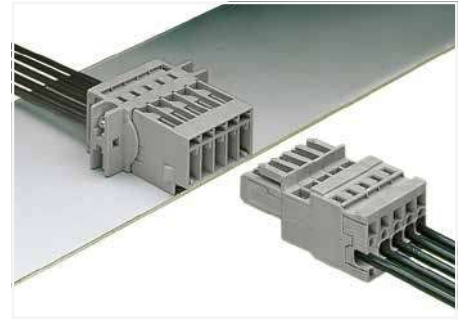

Male connector; with CAGE CLAMP® and mounting flanges
1-connector female plug; straight



Insert a male connector with snap-in flanges
(769-604/005-000) into the cutout.



Male connector; with snap-in flanges
Tool-free assembly



Male connector; with snap-in flanges
Tool-free assembly



Operating tool
Inserting a conductor – side-entry wiring (example shows
a female plug).
With ferruled conductors, it is necessary to use a terminal
block one size smaller than the conductor's nominal cross
section.



Operating tool
Inserting a conductor via operating tool (example shows a
male connector).

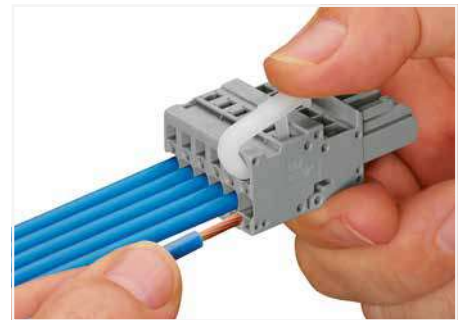

Operating lever
Conductor termination – side-entry wiring (example shows
a female plug)



Strain relief plates can be snapped into both male connector
and female plug.



Labeling a male connector with CAGE CLAMP® connection
via Mini-WSB Quick Markers.



Labeling a female plug with CAGE CLAMP® connection via
Mini-WSB Quick Markers.



CAGE CLAMP® terminates the
following copper conductors:
solid "s"



stranded "st"



fine-stranded "f-st",
also with tinned
single strands

With ferruled conductors, it is necessary to use a terminal block one size smaller than the conductor's nominal cross section.





Coding a female plug by removing coding finger(s) via cutting tool. Do not remove the first and last coding fingers or use an additional locking lever.

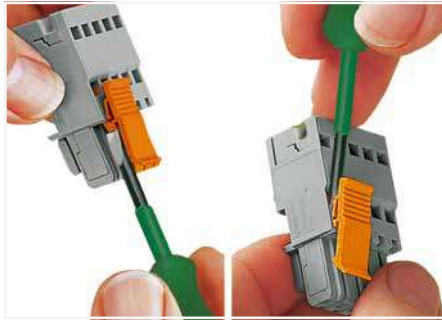

Locking/releasing a lever.



Commoning a 1-conductor female plug via miniature adjacent jumpers.

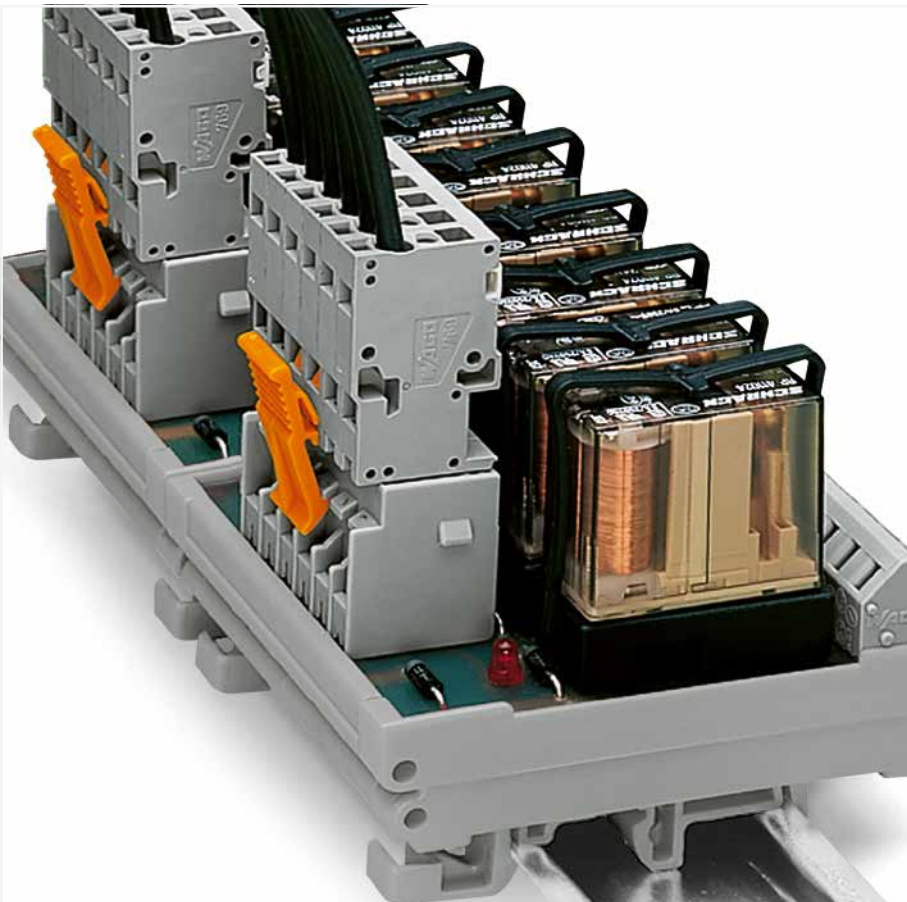

Note: Female plugs used according to the regulations must not be connected/disconnected when live or under load.

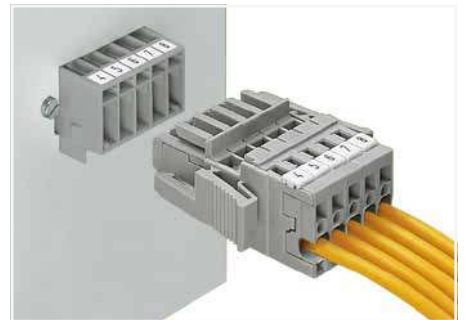

Male header and 1-conductor female plug; with lateral locking levers



Male header; with solder pins for PCBs

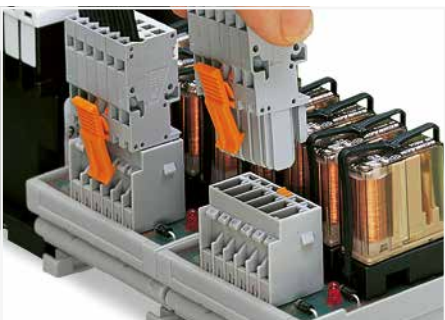

Pluggable PCB connection
Connection to a relay module inside the control cabinet

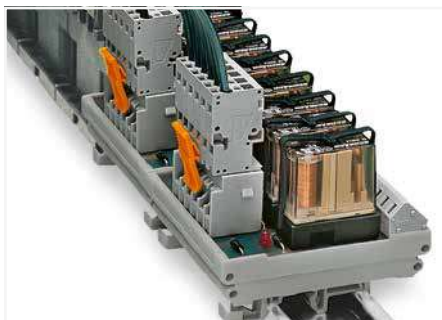

Male header; with straight solder pins and 1-conductor female plug (picture shows a relay module)

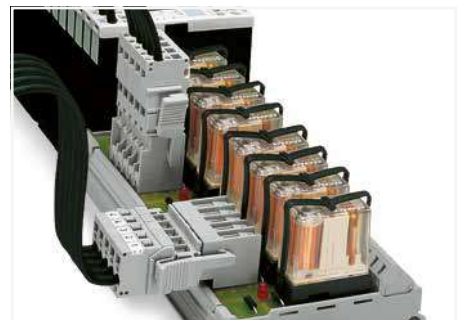

Male header; with solder pins
Integrating PCB components into the system wiring.



fine-stranded,
tip-bonded



fine-stranded,
with ferrule
(gastight crimped)



fine-stranded,
with pin terminal
(gastight crimped)

Male Connector X-COM®-SYSTEM; with CAGE CLAMP® Connection; 5 mm Pin Spacing 4 mm²; 769 Series

Technical Data	
Pin spacing: 5 mm / 0.197 inch	
0.08 ... 4 mm ²	28 ... 12 AWG
500 V / 6 kV / 3 ①	300 V, 20 A ②
I _N 32 A ②	300 V, 20 A ③
8 ... 9 mm / 0.31 ... 0.35 inch	

Technical Data	
Pin spacing: 5 mm / 0.197 inch	
0.08 ... 4 mm ²	28 ... 12 AWG
500 V / 6 kV / 3 ①	300 V, 20 A ②
I _N 32 A ②	300 V, 20 A ③
8 ... 9 mm / 0.31 ... 0.35 inch	

Technical Data	
Pin spacing: 5 mm / 0.197 inch	
0.08 ... 4 mm ²	28 ... 12 AWG
500 V / 6 kV / 3 ①	300 V, 20 A ②
I _N 32 A ②	300 V, 20 A ③
8 ... 9 mm / 0.31 ... 0.35 inch	



Dimensions (in mm)

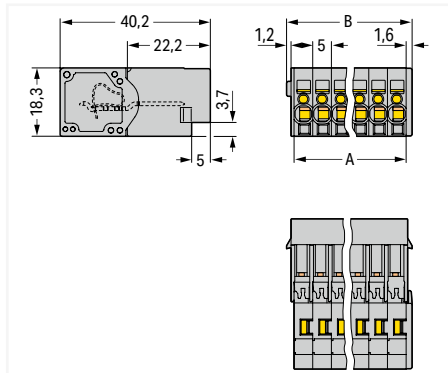

B = A + 3.6 mm
A = pole no. x pin spacing

Male connector; with CAGE CLAMP® connection; for flying leads; gray

Pole No.	Item No.	Pack. Unit
○ 2	769-602	100
○ 3	769-603	100
○ 4	769-604	100
○ 5	769-605	50
○ 6	769-606	50
○ 7	769-607	25
○ 8	769-608	25
○ 9	769-609	25
○ 10	769-610	25
○ 11	769-611	25
○ 12	769-612	25
○ 13	769-613	25
○ 14	769-614	15
○ 15	769-615	10

Accessories; item-specific

Strain relief plate; gray			
	2- ... 3-pole	769-411	100 (25)
	4- ... 5-pole	769-412	100 (25)
	6- ... 9-pole	769-413	100 (25)
	10- ... 15-pole	769-414	100 (25)

Dimensions (in mm)

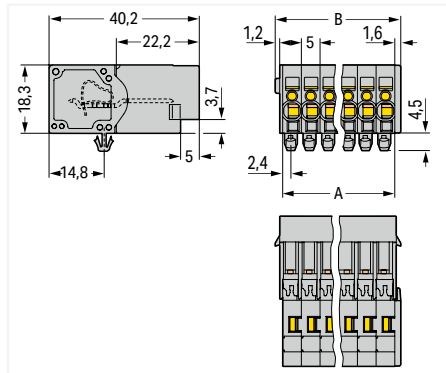

B = A + 3.6 mm
A = pole no. x pin spacing

Male connector; with CAGE CLAMP® connection and snap-in mounting feet; for 0.6 ... 1.2 mm plate thickness; 3.5 mm Ø mounting holes; with mounting adapter (209-137) for DIN-35 rail; gray

Pole No.	Item No.	Pack. Unit
○ 2	769-602/001-000	100
○ 3	769-603/001-000	100
○ 4	769-604/001-000	50
○ 5	769-605/001-000	50
○ 6	769-606/001-000	50
○ 7	769-607/001-000	25
○ 8	769-608/001-000	25
○ 9	769-609/001-000	25
○ 10	769-610/001-000	25
○ 11	769-611/001-000	25
○ 12	769-612/001-000	25
○ 13	769-613/001-000	15
○ 14	769-614/001-000	15
○ 15	769-615/001-000	20

Accessories; item-specific

Mounting adapter; for DIN-35 rail; can be used as end plate; 6.5 mm wide			
	gray	209-137	25

Dimensions (in mm)

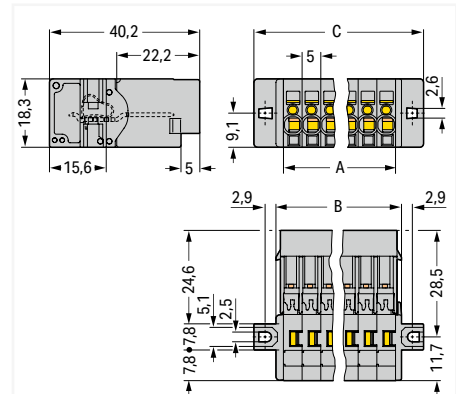

C = A + 15.4 mm
B = A + 3.6 mm
A = pole no. x pin spacing

Male connector; with CAGE CLAMP® connection and mounting flanges; for screw or similar mounting types; for vertical or horizontal mounting; gray

Pole No.	Item No.	Pack. Unit
○ 2	769-602/002-000	100
○ 3	769-603/002-000	50
○ 4	769-604/002-000	50
○ 5	769-605/002-000	50
○ 6	769-606/002-000	50
○ 7	769-607/002-000	25
○ 8	769-608/002-000	25
○ 9	769-609/002-000	25
○ 10	769-610/002-000	25
○ 11	769-611/002-000	25
○ 12	769-612/002-000	25
○ 13	769-613/002-000	15
○ 14	769-614/002-000	10
○ 15	769-615/002-000	20

Accessories; item-specific

Mounting screw (M2.5 x 16) and hexagon nut (M2.5)			
		769-499	100 (25)

Technical Data

Pin spacing: 5 mm / 0.197 inch

0.08 ... 4 mm² | 28 ... 12 AWG

500 V / 6 kV / 3 ① | 300 V, 20 A ②

I_N 32 A ② | 300 V, 20 A ③

8 ... 9 mm / 0.31 ... 0.35 inch



Dimensions (in mm)

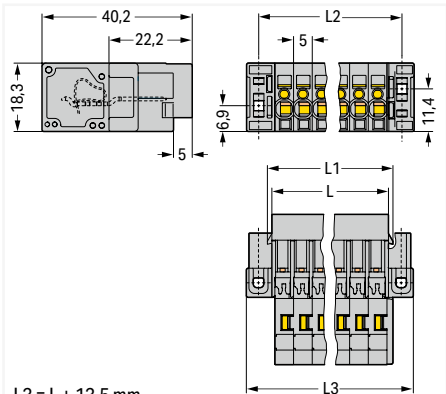

L3 = L + 13.5 mm
 L2 = L + 7 mm
 L1 = L + 2.4 mm
 L = (pole no. - 1) x pin spacing + 6.2 mm

Male connector; with CAGE CLAMP® connection and feedthrough flanges; for screw or similar mounting types; for vertical or horizontal mounting; gray

Pole No.	Item No.	Pack. Unit
○ 2	769-602/004-000	100
○ 3	769-603/004-000	50
○ 4	769-604/004-000	25
○ 5	769-605/004-000	25
○ 6	769-606/004-000	25
○ 7	769-607/004-000	25
○ 8	769-608/004-000	25
○ 9	769-609/004-000	25
○ 10	769-610/004-000	25
○ 11	769-611/004-000	25
○ 12	769-612/004-000	15
○ 13	769-613/004-000	15
○ 14	769-614/004-000	10
○ 15	769-615/004-000	10

- ① 500 V = rated voltage
6 kV = rated impulse voltage
3 = pollution degree
(see Section 15)
 - ② Current-carrying capacity curve on page 456 and upon request
- Approvals and corresponding ratings, visit www.wago.com

Accessories; for male connectors
 Appropriate marking systems:
 Mini-WSB/Mini-WSB Inline

1-conductor female plug; straight

	gray	769-102	100
--	------	---------	-----

1-conductor female plug; with lateral locking levers

	gray	769-102/021-000	50
--	------	-----------------	----

2-conductor female plug

	gray	769-122	50
--	------	---------	----

Coding pin; for coding female plugs

	orange	769-435	100 (25)
--	--------	---------	----------

Operating tool; for female plugs and male connectors with CAGE CLAMP® connection

		210-490	1
--	--	---------	---

Operating lever; loose; for male and female connectors with CAGE CLAMP® connection

		769-434	2000 (100)
--	--	---------	------------

Mini-WSB Inline, plain; 1,700 WMB markers (5 mm)/reel; 5 ... 5.2 mm stretchable

	white	2009-145	1
--	-------	----------	---

Mini-WSB marking card; white; 10 strips with 10 markers/card; 5 mm wide markers

	plain	248-501	5
--	-------	---------	---



Male connector; with CAGE CLAMP® connection
 1-conductor female plug; straight

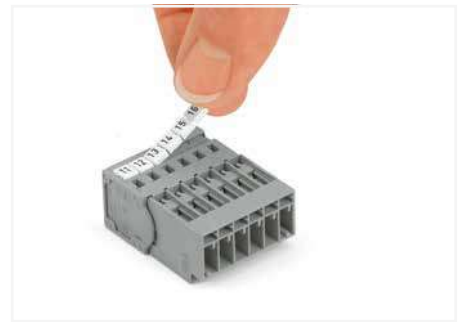

Labeling a male connector with CAGE CLAMP® connection via Mini-WSB Quick Markers.

CAGE CLAMP®

Male Connector X-COM®-SYSTEM; with CAGE CLAMP® Connection and Snap-In Flanges; 5 mm Pin Spacing

4 mm²; 769 Series

Technical Data

Pin spacing: 5 mm / 0.197 inch

0.08 ... 4 mm²

28 ... 12 AWG

500 V / 6 kV / 3 ①

300 V, 20 A ②

I_N 32 A ②

300 V, 20 A ③

8 ... 9 mm / 0.31 ... 0.35 inch



- ① 500 V = rated voltage
6 kV = rated impulse voltage
3 = pollution degree
(see Section 15)
- ② Current-carrying capacity curves upon request

Approvals and corresponding ratings, visit www.wago.com

Accessories; for male connectors

Appropriate marking systems:
Mini-WSB/Mini-WSB Inline

1-conductor female plug; straight

	gray	769-102	100
--	------	---------	-----

1-conductor female plug; with lateral locking levers

	gray	769-102/021-000	50
--	------	-----------------	----

2-conductor female plug

	gray	769-122	50
--	------	---------	----

Coding pin; for coding female plugs

	orange	769-435	100 (25)
--	--------	---------	----------

Operating tool; for female plugs and male connectors with CAGE CLAMP® connection

		210-490	1
--	--	---------	---

Operating lever; loose; for male and female connectors with CAGE CLAMP® connection

		769-434	2000 (100)
--	--	---------	------------

Mini-WSB Inline, plain; 1,700 WMB markers (5 mm)/reel; 5 ... 5.2 mm stretchable

	white	2009-145	1
--	-------	----------	---

Mini-WSB marking card; white; 10 strips with 10 markers/ card; 5 mm wide markers

	plain	248-501	5
--	-------	---------	---

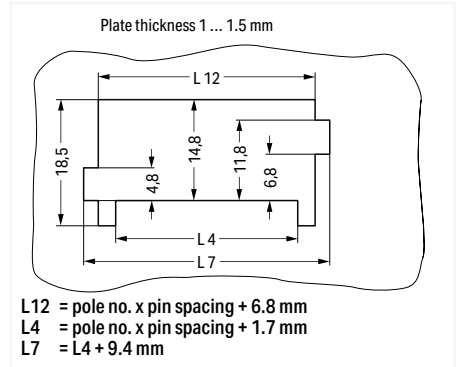

Cutout

Male connector with CAGE CLAMP® connection (769-6xx/005-000) and snap-in flanges



Insert a male connector with snap-in flanges (769-604/005-000) into the cutout.



Male connector; with snap-in flanges
Tool-free assembly



Male connector; with snap-in flanges
Tool-free assembly

Dimensions (in mm)

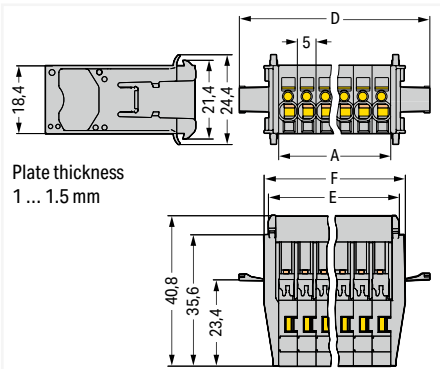

Plate thickness
1 ... 1.5 mm

F = A + 8.1 mm
E = A + 4.9 mm
D = A + 21.3 mm
A = pole no. x pin spacing

Male connector; with CAGE CLAMP® connection and snap-in flanges; for flying leads; gray

Pole No.	Item No.	Pack. Unit
2	769-602/005-000	50
3	769-603/005-000	25
4	769-604/005-000	25
5	769-605/005-000	25
6	769-606/005-000	25
7	769-607/005-000	25
8	769-608/005-000	20
9	769-609/005-000	20
10	769-610/005-000	20
11	769-611/005-000	15
12	769-612/005-000	15
13	769-613/005-000	15
14	769-614/005-000	10
15	769-615/005-000	10

7

Male Connector X-COM®-SYSTEM; with CAGE CLAMP® Connection and Snap-In Flanges; 5 mm Pin Spacing

4 mm²; 769 Series

Technical Data

Pin spacing: 5 mm / 0.197 inch	
0.08 ... 4 mm ² 28 ... 12 AWG	
500 V / 6 kV / 3 ①	300 V, 20 A
I _N 32 A ②	300 V, 20 A
8 ... 9 mm / 0.31 ... 0.35 inch	

- ① 500 V = rated voltage
6 kV = rated impulse voltage
3 = pollution degree
(see Section 15)
 - ② Current-carrying capacity curves upon request
- Approvals and corresponding ratings, visit www.wago.com

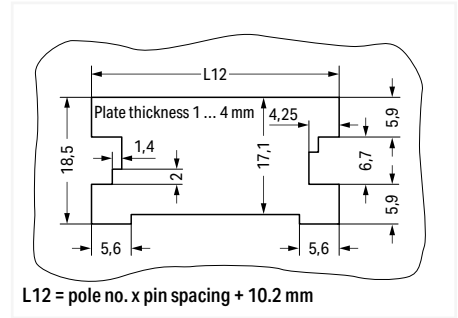

Sheet metal cutout (for female connectors without locking levers)
Male connector with CAGE CLAMP® connection (769-6xx/006-000) and snap-in flanges



Dimensions (in mm)

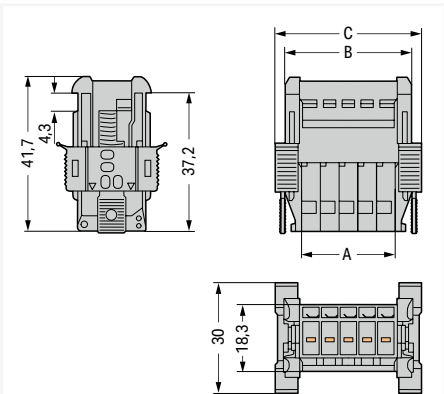

$C = A + 14.3 \text{ mm}$
 $B = A + 9.3 \text{ mm}$
 $A = \text{pole no.} \times \text{pin spacing}$

Male connector; with CAGE CLAMP® connection and snap-in flanges; for flying leads; gray

Pole No.	Item No.	Pack. Unit
○ 2	769-602/006-000	50
○ 3	769-603/006-000	25
○ 4	769-604/006-000	25
○ 5	769-605/006-000	25
○ 6	769-606/006-000	25
○ 7	769-607/006-000	25
○ 8	769-608/006-000	20
○ 9	769-609/006-000	20
○ 10	769-610/006-000	20
○ 11	769-611/006-000	15
○ 12	769-612/006-000	15
○ 13	769-613/006-000	15
○ 14	769-614/006-000	10
○ 15	769-615/006-000	10



Insert a male connector with snap-in flanges (769-605/006-000) into the cutout.



Secure the snap-in flange.



For removal, insert operating tool (2.5 mm blade) into release slot.

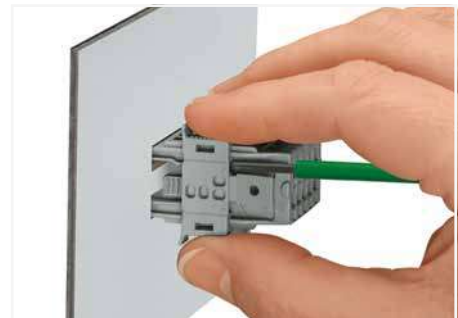

Press center part on both the top and bottom of the connector. Then remove snap-in flange.

Male Header X-COM®-SYSTEM; with Solder Pins; 5 mm Pin Spacing 769 Series

Technical Data

Pin spacing: 5 mm / 0.197 inch

250 V / 4 kV / 3 ① | 300 V, 20 A ②

500 V / 4 kV / 2 ① | 300 V, 20 A ②

I_N 32 A ②

Technical Data

Pin spacing: 5 mm / 0.197 inch

250 V / 4 kV / 3 ① | 300 V, 20 A ②

500 V / 4 kV / 2 ① | 300 V, 20 A ②

I_N 32 A ②

- ① 250 V / 500 V = rated voltage
4 kV = rated impulse voltage
3 = pollution degree
(see Section 15)

- ② Current-carrying capacity curve on page 457 and upon request

Approvals and corresponding ratings, visit www.wago.com



Dimensions (in mm)

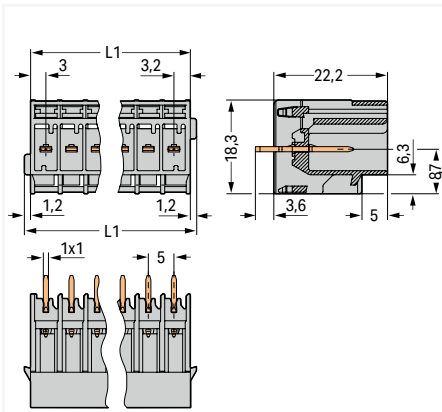

$L1 = L + 2.4 \text{ mm}$
 $L = (\text{pole no.} - 1) \times \text{pin spacing} + 6.2 \text{ mm}$

Male header; with straight solder pins; 1 x 1 mm; Vertical mating direction to the PCB; gray

Pole No.	Item No.	Pack. Unit
2	769-632	200
3	769-633	100
4	769-634	50
5	769-635	50
6	769-636	50
7	769-637	50
8	769-638	25
9	769-639	25
10	769-640	25
11	769-641	25
12	769-642	25
13	769-643	25
14	769-644	25
15	769-645	25

Dimensions (in mm)

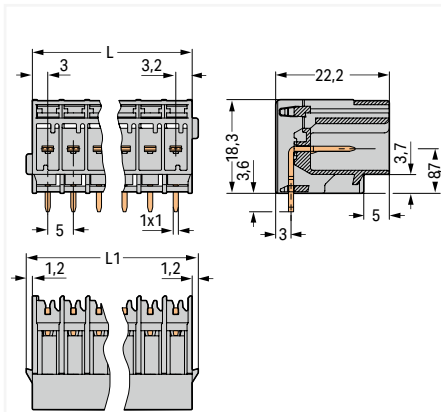

$L1 = L + 2.4 \text{ mm}$
 $L = (\text{pole no.} - 1) \times \text{pin spacing} + 6.2 \text{ mm}$

Male header; with angled solder pins; 1 x 1 mm; Horizontal mating direction to the PCB; gray

Pole No.	Item No.	Pack. Unit
2	769-662	200
3	769-663	100
4	769-664	50
5	769-665	50
6	769-666	50
7	769-667	50
8	769-668	25
9	769-669	25
10	769-670	25
11	769-671	25
12	769-672	25
13	769-673	25
14	769-674	25
15	769-675	25

Male header; with preceding contact; with straight solder pins; 1 x 1 mm; Vertical mating direction to the PCB; gray

Pole No.	Item No.	Pack. Unit
2	769-632/000-036	200
3	769-633/000-036	100
4	769-634/000-036	50
5	769-635/000-036	50

Accessories; for male connectors

1-connector female plug; straight

Color	Item No.	Pack. Unit
gray	769-102	100

1-conductor female plug; with lateral locking levers

Color	Item No.	Pack. Unit
gray	769-102/021-000	50

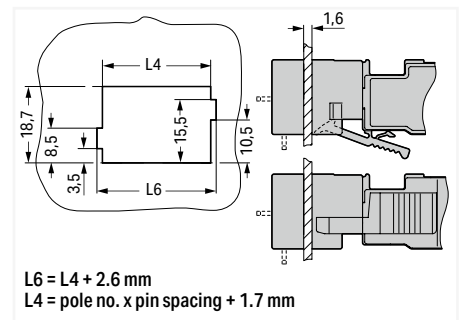

$L6 = L4 + 2.6 \text{ mm}$
 $L4 = \text{pole no.} \times \text{pin spacing} + 1.7 \text{ mm}$

Cutout
Male header; with solder pins

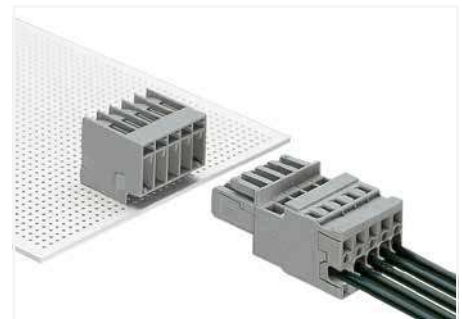

Male header; with angled solder pins

Male Header X-COM®-SYSTEM; with Solder Pins and Mounting Flanges; 5 mm Pin Spacing 769 Series

Technical Data

Pin spacing: 5 mm / 0.197 inch

250 V / 4 kV / 3 ① | 300 V, 20 A^{RA}

500 V / 4 kV / 2 ① | 300 V, 20 A^{AE}

I_N 32 A ②

Technical Data

Pin spacing: 5 mm / 0.197 inch

250 V / 4 kV / 3 ① | 300 V, 20 A^{RA}

500 V / 4 kV / 2 ① | 300 V, 20 A^{AE}

I_N 32 A ②

- ① 250 V / 500 V = rated voltage
4 kV = rated impulse voltage
3 = pollution degree
(see Section 15)

- ② Current-carrying capacity curve on page 457 and upon request

Approvals and corresponding ratings, visit www.wago.com

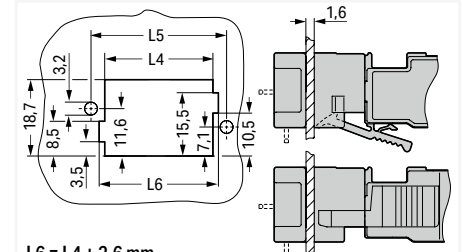

L6 = L4 + 2.6 mm
L5 = L5 + 6.6 mm
L4 = pole no. x pin spacing + 1.7 mm

Cutout

Male header; with solder pins and mounting flanges

Dimensions (in mm)

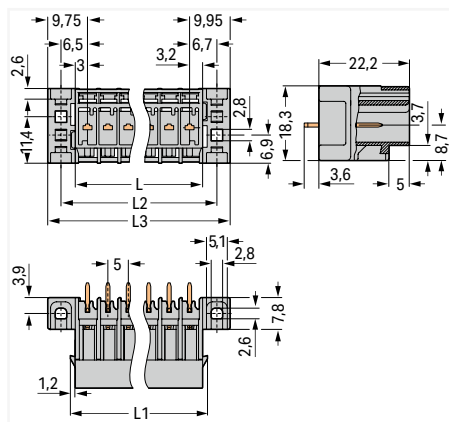

L1 = L + 2.4 mm, L2 = L + 7 mm, L3 = L + 13.5 mm
L = (pole no. - 1) x pin spacing + 6.2 mm

Dimensions (in mm)

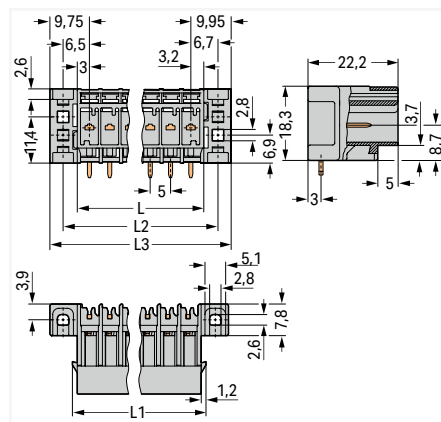

L1 = L + 2.4 mm, L2 = L + 7 mm, L3 = L + 13.5 mm
L = (pole no. - 1) x pin spacing + 6.2 mm

Male header; with straight solder pins and mounting flanges; 1 x 1 mm; Vertical mating direction to the PCB; gray

Pole No.	Item No.	Pack. Unit
2	769-632/003-000	200
3	769-633/003-000	100
4	769-634/003-000	50
5	769-635/003-000	50
6	769-636/003-000	25
7	769-637/003-000	25
8	769-638/003-000	25
9	769-639/003-000	25
10	769-640/003-000	25
11	769-641/003-000	25
12	769-642/003-000	25
13	769-643/003-000	15
14	769-644/003-000	15
15	769-645/003-000	15

Male header; with angled solder pins and mounting flanges; 1 x 1 mm; Horizontal mating direction to the PCB; gray

Pole No.	Item No.	Pack. Unit
2	769-662/003-000	100
3	769-663/003-000	100
4	769-664/003-000	50
5	769-665/003-000	50
6	769-666/003-000	50
7	769-667/003-000	25
8	769-668/003-000	25
9	769-669/003-000	25
10	769-670/003-000	25
11	769-671/003-000	25
12	769-672/003-000	25
13	769-673/003-000	15
14	769-674/003-000	15
15	769-675/003-000	15

Male header; with preceding contact; with straight solder pins and mounting flanges; 1 x 1 mm; Vertical mating direction to the PCB; gray

2	769-632/003-036	200
3	769-633/003-036	100
4	769-634/003-036	50
5	769-635/003-036	50
6	769-636/003-036	25

Accessories; for male connectors

1-conductor female plug; straight

	gray	769-102	100
--	------	---------	-----

1-conductor female plug; with lateral locking levers

	gray	769-102/021-000	50
--	------	-----------------	----

Male header; with preceding contact; with straight solder pins and mounting flanges

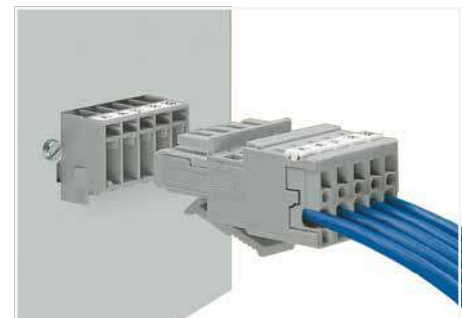

Male header with mounting flanges
1-conductor female plug with bottom-mount locking levers

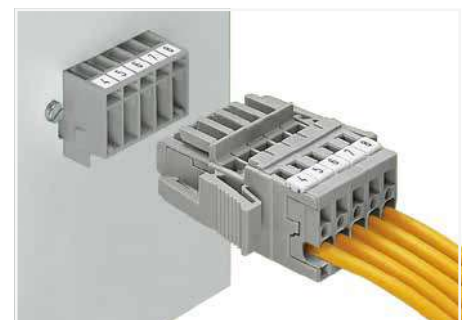

Male header and 1-conductor female plug with lateral locking levers

Male Header X-COM®-SYSTEM; with Solder Pins and Feedthrough Flanges; 5 mm Pin Spacing 769 Series

Technical Data

Pin spacing: 5 mm / 0.197 inch

250 V / 4 kV / 3 ① | 300 V, 20 A^{II}

500 V / 4 kV / 2 ① | 300 V, 20 A^{III}

I_N 32 A ②

Technical Data

Pin spacing: 5 mm / 0.197 inch

250 V / 4 kV / 3 ① | 300 V, 20 A^{II}

500 V / 4 kV / 2 ① | 300 V, 20 A^{III}

I_N 32 A ②

- ① 250 V / 500 V = rated voltage
4 kV = rated impulse voltage
3 = pollution degree
(see Section 15)

- ② Current-carrying capacity curve on page 457 and upon request

Approvals and corresponding ratings, visit www.wago.com



Dimensions (in mm)

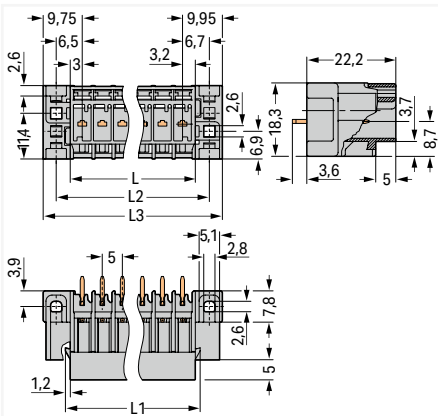

L1 = L + 2.4 mm, L2 = L + 7 mm, L3 = L + 13.5 mm
L = (pole no. - 1) x pin spacing + 6.2 mm

Dimensions (in mm)

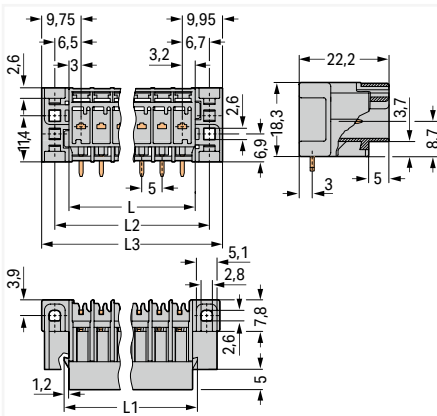

L1 = L + 2.4 mm, L2 = L + 7 mm, L3 = L + 13.5 mm
L = (pole no. - 1) x pin spacing + 6.2 mm

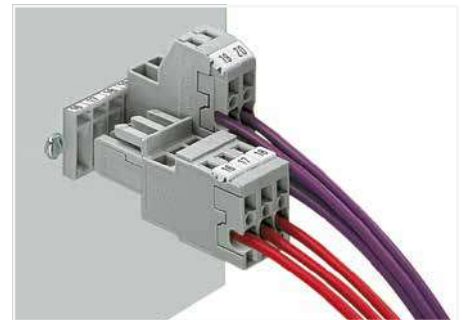

Male header; with feedthrough flanges
1-conductor female plug
2-conductor female plug

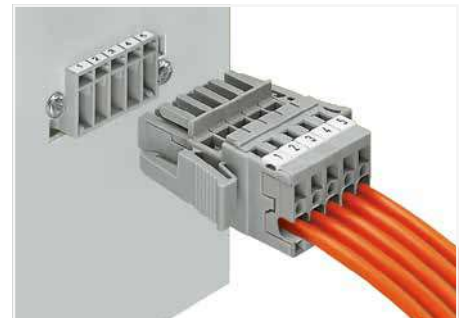

Male header and 1-conductor female plug with lateral locking levers

Male header; with straight solder pins and feedthrough flanges; 1 x 1 mm; Vertical mating direction to the PCB; gray

Pole No.	Item No.	Pack. Unit
2	769-632/004-000	200
3	769-633/004-000	50
4	769-634/004-000	50
5	769-635/004-000	50
6	769-636/004-000	50
7	769-637/004-000	25
8	769-638/004-000	25
9	769-639/004-000	25
10	769-640/004-000	25
11	769-641/004-000	25
12	769-642/004-000	25
13	769-643/004-000	15
14	769-644/004-000	15
15	769-645/004-000	15

Male header; with angled solder pins and feedthrough flanges; 1 x 1 mm; Horizontal mating direction to the PCB; gray

Pole No.	Item No.	Pack. Unit
2	769-662/004-000	200
3	769-663/004-000	100
4	769-664/004-000	50
5	769-665/004-000	50
6	769-666/004-000	50
7	769-667/004-000	50
8	769-668/004-000	25
9	769-669/004-000	25
10	769-670/004-000	25
11	769-671/004-000	25
12	769-672/004-000	25
13	769-673/004-000	25
14	769-674/004-000	15
15	769-675/004-000	15

Accessories; for male connectors

1-conductor female plug; straight

	gray	769-102	100
--	------	---------	-----

1-conductor female plug; with lateral locking levers

	gray	769-102/021-000	50
--	------	-----------------	----

Coding pin; for coding female plugs

	orange	769-435	100 (25)
--	--------	---------	----------

Male Headers X-COM®-SYSTEM; with Solder Pins; with 1-/2-Conductor Female Plugs Assembly Types

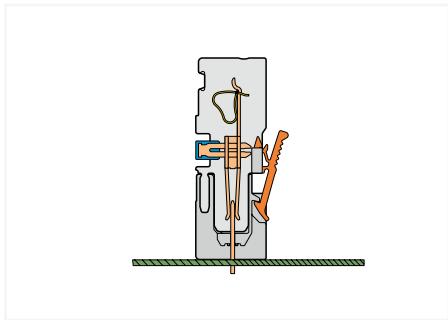

Male header; with straight solder pins

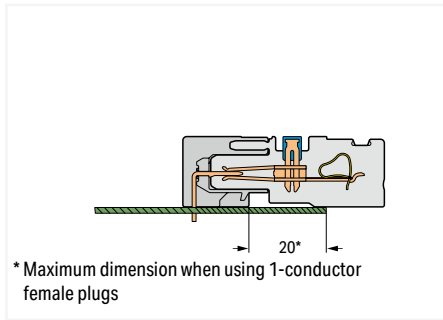

* Maximum dimension when using 1-conductor female plugs

Male header; with angled solder pins

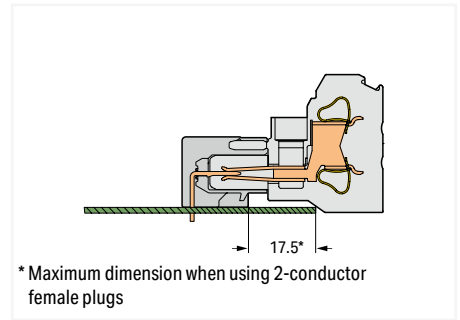

* Maximum dimension when using 2-conductor female plugs

Male header; with angled solder pins

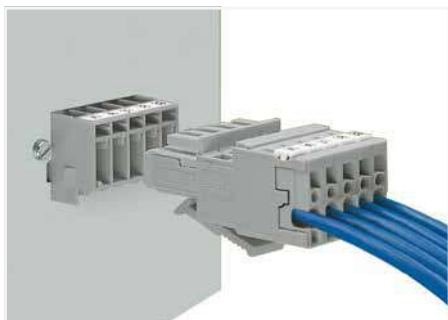

Male header; with mounting flanges
1-conductor female plug; with bottom-mount locking levers

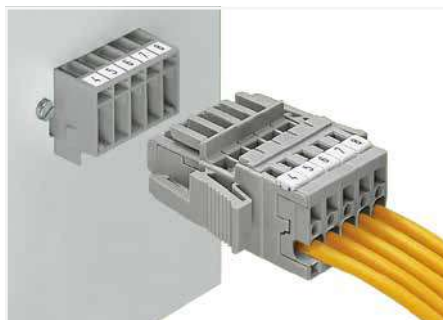

Male header; with mounting flanges
1-conductor female plug; with lateral locking levers

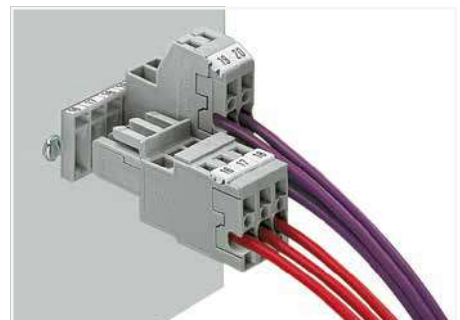

Male header; with feedthrough flanges
1-conductor female plug
2-conductor female plug

7

Cutouts for headers with fixing flanges for feedthrough applications and locking levers

Female plugs with bottom-mounted locking levers

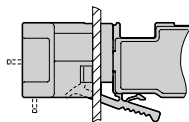

Cutouts for 2-pole locking levers (2- to 15-pole female plugs)

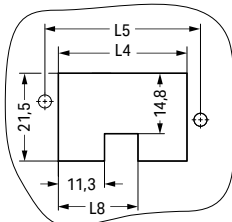

Layout for locking levers outer ...

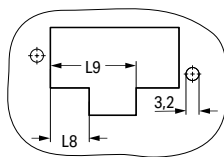

... inner

Cutouts for single pole locking levers

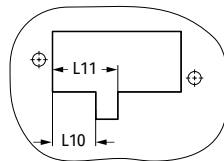
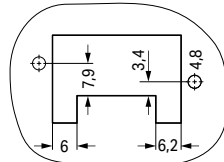

Female plug without locking levers

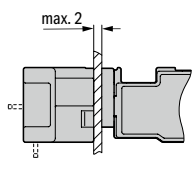
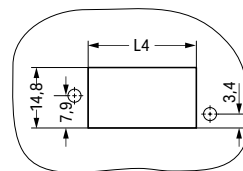

Female plug with lateral locking levers

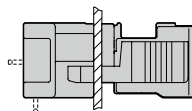
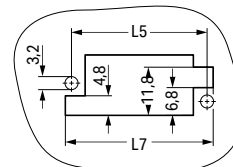

- L 4 = pole no. x pin spacing + 1.7 mm
- L 5 = L 4 + 6.6 mm
- L 7 = L 4 + 9.4 mm
- L 8 = pole no. LL x pin spacing - 0.3 mm
- L 9 = L 8 + 11.6 mm
- L 10 = pole no. LL x pin spacing + 0.6 mm
- L 11 = L 10 + 5.4 mm
- Pole no. LL: Number of poles ahead of the poles attached to the locking lever
- LL = locking lever

Male Header X-COM®-SYSTEM; with Solder Pins and Rivet Mounting Flanges; 5 mm Pin Spacing 769 Series

Technical Data

Pin spacing: 5 mm / 0.197 inch

250 V / 4 kV / 3 ①

500 V / 4 kV / 2 ①

I_N 32 A ②

- ① 250 V / 500 V = rated voltage
4 kV = rated impulse voltage
3 = pollution degree
(see Section 15)

- ② Current-carrying capacity curves upon request

Approvals and corresponding ratings,
visit www.wago.com

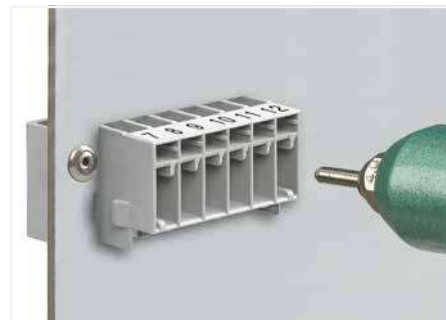

Mounting with 3 mm Ø blind rivets

Dimensions (in mm)

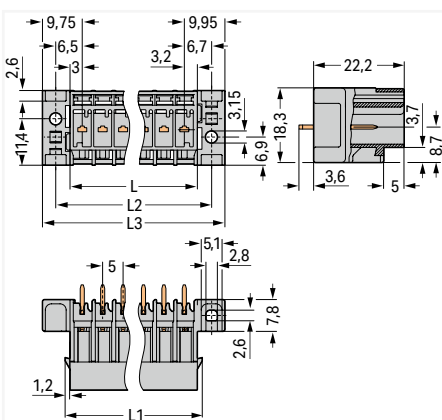

$$L1 = L + 2.4 \text{ mm}, L2 = L + 7 \text{ mm}, L3 = L + 13.5 \text{ mm}$$

$$L = (\text{pole no.} - 1) \times \text{pin spacing} + 6.2 \text{ mm}$$

Male header; with straight solder pins and rivet mounting flanges; 1 x 1 mm; Vertical mating direction to the PCB; gray

Pole No.	Item No.	Pack. Unit
2	769-632/007-000	200
3	769-633/007-000	50
4	769-634/007-000	50
5	769-635/007-000	50
6	769-636/007-000	50
7	769-637/007-000	25
8	769-638/007-000	25
9	769-639/007-000	25
10	769-640/007-000	25
11	769-641/007-000	25
12	769-642/007-000	25
13	769-643/007-000	15
14	769-644/007-000	15
15	769-645/007-000	15

Accessories; for male connectors

1-conductor female plug; straight

	gray	769-102	100
---	------	---------	-----

1-conductor female plug; with lateral locking levers

	gray	769-102/021-000	50
---	------	-----------------	----

Coding pin; for coding female plugs

	orange	769-435	100 (25)
--	--------	---------	----------

1-Conductor Female Plug X-COM®-SYSTEM

4 mm²; 769 Series

Technical Data

0.08 ... 4 mm ²	28 ... 12 AWG
500 V / 6 kV / 3 ①	300 V, 20 A
I _N 32 A ②	300 V, 20 A
Module width: 5 mm / 0.197 inch	
8 ... 9 mm / 0.31 ... 0.35 inch	



Dimensions (in mm)

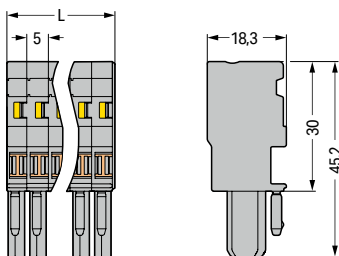

L = pole no. x module width

1-conductor female plug; straight; fits into carrier terminal blocks or male connectors; with coding fingers; can be commoned with miniature adjacent jumpers; gray

Pole No.	Item No.	Pack. Unit
1	769-101	200
2	769-102	100
3	769-103	50
4	769-104	50
5	769-105	50
6	769-106	25
7	769-107	25
8	769-108	25
9	769-109	25
10	769-110	25
11	769-111	20
12	769-112	20
13	769-113	10
14	769-114	10
15	769-115	10

1-conductor female plug; straight; fits into carrier terminal blocks or male connectors; with coding fingers; can be commoned with miniature adjacent jumpers

1 blue	769-101/000-006	200
1 green-yellow	769-101/000-016	200

- ① 500 V = rated voltage
6 kV = rated impulse voltage
3 = pollution degree
(see Section 15)
- ② Current-carrying capacity curve from page 453 and upon request

Item no. suffixes
blue .../000-006

Snap-on type strain relief housing, see page 452

Note:
According to EN 61984, pluggable connectors without a current interrupting capacity must not be mated or unmated when live or under load.

Approvals and corresponding ratings, visit www.wago.com

Accessories; for female plugs
Appropriate marking systems:
Mini-WSB/Mini-WSB Inline

Insulation stop; 0.08 ... 0.2 mm² "s" (0.14 mm² "f-st"); 5 pcs/strip

white	769-470	200 (25)
-------	---------	----------

Insulation stop; 0.25 ... 0.5 mm²; 5 pcs/strip

light gray	769-471	200 (25)
------------	---------	----------

Insulation stop; 0.75 ... 1 mm²; 5 pcs/strip

dark gray	769-472	200 (25)
-----------	---------	----------

Protective warning marker; with black high-voltage symbol; for 5 terminal blocks

yellow	280-415	100 (25)
--------	---------	----------

Adjacent jumper; insulated; I_N 24 A

gray	769-402	100 (25)
------	---------	----------

Jumper cover; for 1-conductor female plugs; for 5 poles

gray	769-436	100 (25)
------	---------	----------

Operating lever; loose; for male and female connectors with CAGE CLAMP® connection

yellow	769-434	2000 (100)
--------	---------	------------

Locking Lever; for 1-pole female plugs

gray	769-428	100 (25)
orange	769-429	100 (25)

Locking lever; for female plugs with 2 poles and more

gray	769-431	100 (25)
orange	769-430	100 (25)

Strain relief plate; gray

1-pole	769-410	100 (25)
2- ... 3-pole	769-411	100 (25)
4- ... 5-pole	769-412	100 (25)

Strain relief plate; gray

6- ... 9-pole	769-413	100 (25)
10- ... 15-pole	769-414	100 (25)

Accessories; for female plugs

Appropriate marking systems:
Mini-WSB/Mini-WSB Inline

Snap-on type strain relief housing; consists of strain relief support and housing

5-pole	769-1605	25
--------	----------	----

Mini-WSB Inline, plain; 1,700 WMB markers (5 mm)/reel; 5 ... 5.2 mm stretchable

white	2009-145	1
-------	----------	---

Mini-WSB marking card; white; 10 strips with 10 markers/card; 5 mm wide markers

plain	248-501	5
-------	---------	---



1-pole female plug
Application examples:

- Phase selection in three-phase network
- Test plug with rated current capability
- Simplified circuit expansion – addition of base circuits requires only female plugs to be plugged in

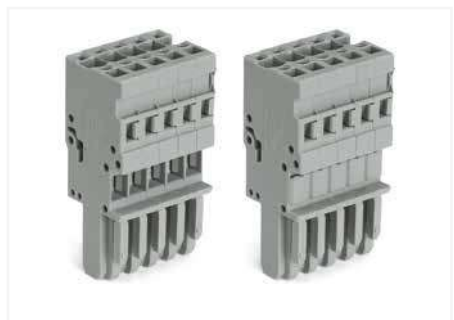

Jumper cover for 1-conductor female plugs

1-Conductor Female Plug X-COM®-SYSTEM; with Lateral Locking Levers 4 mm²; 769 Series

Technical Data

0.08 ... 4 mm ²	28 ... 12 AWG
500 V / 6 kV / 3 ①	300 V, 20 A
I _N 32 A ②	300 V, 20 A
Module width: 5 mm / 0.197 inch	
8 ... 9 mm / 0.31 ... 0.35 inch	



Dimensions (in mm)

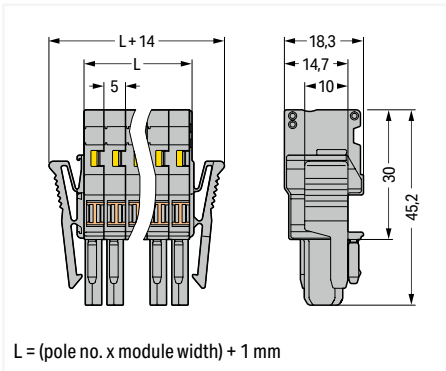

1-conductor female plug; with lateral locking levers; only compatible with male connectors; codable; can be commoned with miniature adjacent jumpers; gray

Pole No.	Item No.	Pack. Unit
2	769-102/021-000	200
3	769-103/021-000	50
4	769-104/021-000	50
5	769-105/021-000	50
6	769-106/021-000	50
7	769-107/021-000	25
8	769-108/021-000	25
9	769-109/021-000	25
10	769-110/021-000	25
11	769-111/021-000	25
12	769-112/021-000	25
13	769-113/021-000	15
14	769-114/021-000	15
15	769-115/021-000	15

- ① 500 V = rated voltage
6 kV = rated impulse voltage
3 = pollution degree
(see Section 15)
- ② Current-carrying capacity curve from page 455 and upon request

Snap-on type strain relief housing, see page 452

Note:
According to EN 61984, pluggable connectors without a current interrupting capacity must not be mated or unmated when live or under load.

Approvals and corresponding ratings, visit www.wago.com

Accessories; for female plugs

Appropriate marking systems:
Mini-WSB/Mini-WSB Inline

Insulation stop; 0.08 ... 0.2 mm² "s" (0.14 mm² "f-st"); 5 pcs/strip

white	769-470	200 (25)
-------	---------	----------

Insulation stop; 0.25 ... 0.5 mm²; 5 pcs/strip

light gray	769-471	200 (25)
------------	---------	----------

Insulation stop; 0.75 ... 1 mm²; 5 pcs/strip

dark gray	769-472	200 (25)
-----------	---------	----------

Protective warning marker; with black high-voltage symbol; for 5 terminal blocks

yellow	280-415	100 (25)
--------	---------	----------

Adjacent jumper; insulated; I_N 24 A

gray	769-402	100 (25)
------	---------	----------

Jumper cover; for 1-conductor female plugs; for 5 poles

gray	769-436	100 (25)
------	---------	----------

Operating lever; loose; for male and female connectors with CAGE CLAMP® connection

gray	769-434	2000 (100)
------	---------	------------

Strain relief plate; gray

2- ... 3-pole	769-411	100 (25)
4- ... 5-pole	769-412	100 (25)

Strain relief plate; gray

6- ... 9-pole	769-413	100 (25)
10- ... 15-pole	769-414	100 (25)

Snap-on type strain relief housing; consists of strain relief support and housing

5-pole	769-1605	25
--------	----------	----

Accessories; for female plugs

Appropriate marking systems:
Mini-WSB/Mini-WSB Inline

Mini-WSB Inline, plain; 1,700 WMB markers (5 mm)/reel; 5 ... 5.2 mm stretchable

white	2009-145	1
-------	----------	---

Mini-WSB marking card; white; 10 strips with 10 markers/card; 5 mm wide markers

plain	248-501	5
-------	---------	---

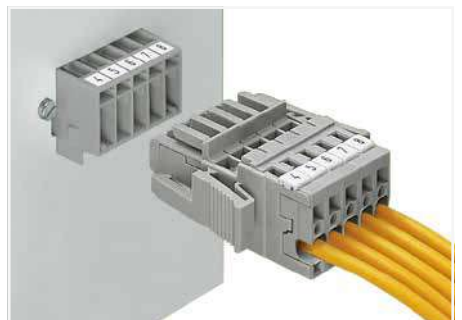

Male header; with mounting flanges
1-conductor female plug with lateral locking levers

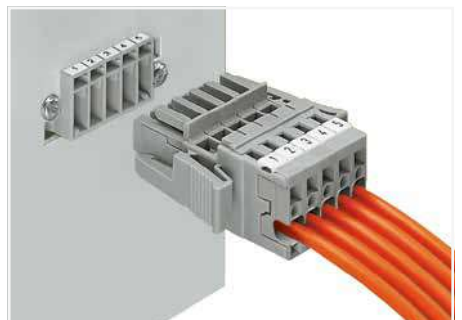

Male header and 1-conductor female plug with lateral locking levers

7

2-Conductor Female Plug X-COM®-SYSTEM 4 mm²; 769 Series

Technical Data

0.08 ... 4 mm ²	28 ... 12 AWG
500 V / 6 kV / 3 ①	300 V, 20 A ^{II}
I _N 32 A ②	300 V, 20 A [@]
Module width: 5 mm / 0.197 inch	
8 ... 9 mm / 0.31 ... 0.35 inch	

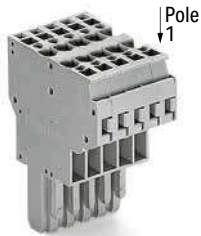

Dimensions (in mm)

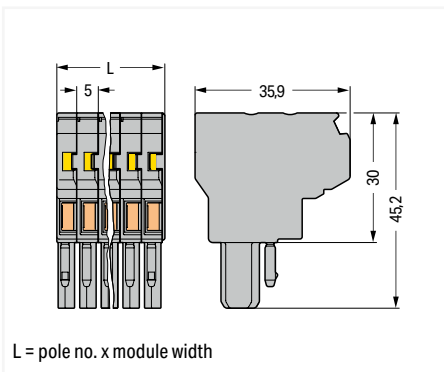

2-conductor female plug; fits into carrier terminal blocks or male connectors; codable; can be commoned with adjacent and staggered jumpers; gray

Pole No.	Item No.	Pack. Unit
1	769-121	100
2	769-122	50
3	769-123	25
4	769-124	25
5	769-125	20
6	769-126	10
7	769-127	10
8	769-128	10
9	769-129	10
10	769-130	10
11	769-131	5
12	769-132	5
13	769-133	5
14	769-134	5
15	769-135	5

2-conductor female plug; fits into carrier terminal blocks or male connectors; codable; can be commoned with adjacent and staggered jumpers

1 green-yellow	769-121/000-016	100
----------------	-----------------	-----

- 500 V = rated voltage
6 kV = rated impulse voltage
3 = pollution degree
(see Section 15)
- Current-carrying capacity curves upon request

Please observe the application notes:
Jumpers, from page 426

Note:
According to EN 61984, pluggable connectors without a current interrupting capacity must not be mated or unmated when live or under load.

Approvals and corresponding ratings,
visit www.wago.com

Accessories; for female plugs

Appropriate marking systems:
Mini-WSB/Mini-WSB Inline

Insulation stop; 0.08 ... 0.2 mm² "s" (0.14 mm² "f-st"); 5 pcs/strip

white	769-470	200 (25)
-------	---------	----------



Insulation stop; 0.25 ... 0.5 mm²; 5 pcs/strip

light gray	769-471	200 (25)
------------	---------	----------



Insulation stop; 0.75 ... 1 mm²; 5 pcs/strip

dark gray	769-472	200 (25)
-----------	---------	----------



Protective warning marker; with black high-voltage symbol; for 5 terminal blocks

yellow	280-415	100 (25)
--------	---------	----------



Adjacent jumper; insulated; I_N = I_N terminal block

gray	280-402	200 (25)
------	---------	----------



Staggered jumper; insulated; 5 mm wide; I_N 24 A

1 to 2	780-452	100 (25)
1 to 3	780-453	100 (25)
1 to 4	780-454	100 (25)
1 to 5	780-455	50 (25)
1 to 6	780-456	50 (25)
1 to 7	780-457	50 (25)
1 to 8	780-458	50 (25)

Locking Lever; for 1-pole female plugs

gray	769-428	100 (25)
orange	769-429	100 (25)



Locking lever; for female plugs with 2 poles and more

gray	769-431	100 (25)
orange	769-430	100 (25)



Strain relief plate; gray

1-pole	769-410	100 (25)
2- ... 3-pole	769-411	100 (25)
4- ... 5-pole	769-412	100 (25)



Strain relief plate; gray

6- ... 9-pole	769-413	100 (25)
10- ... 15-pole	769-414	100 (25)



Accessories; for female plugs

Appropriate marking systems:
Mini-WSB/Mini-WSB Inline

Mini-WSB Inline, plain; 1,700 WMB markers (5 mm)/reel; 5 ... 5.2 mm stretchable

white	2009-145	1
-------	----------	---



Mini-WSB marking card; white; 10 strips with 10 markers/card; 5 mm wide markers

plain	248-501	5
-------	---------	---

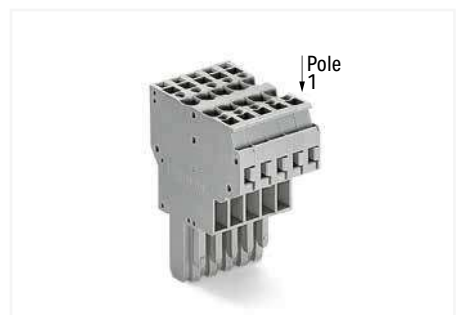

2-conductor female plugs:

- Common signals from one subassembly to the other (bus structure)
- Can be used as a T-wire branch tap connection (e.g. for lighting wiring)
- Enable a higher number of connection possibilities

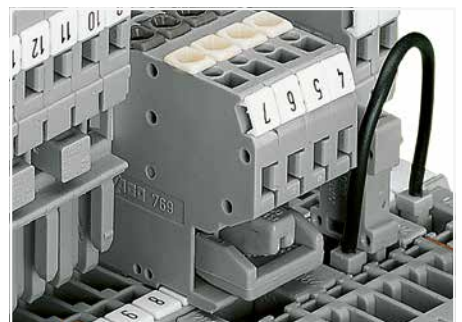

Commoning options of female plugs:

- After removal, commoned potentials still remain commoned
- Use of plug-in jumpers instead of additional wired jumpers
- Can be used as a "hardware" key for safety lockout
- Can also be used as a commoning jumper for sensor circuits or machine programming

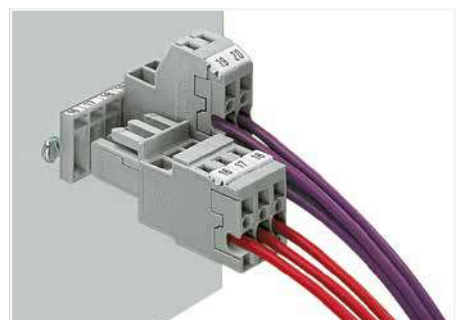

Male header; with feedthrough flanges
1-conductor female plug
2-conductor female plug

7

1-Conductor Female Plug X-COM®-SYSTEM; Angled 4 mm²; 769 Series

Technical Data

0.08 ... 4 mm ²	28 ... 12 AWG
500 V / 6 kV / 3 ①	300 V, 20 A
I _N 32 A ②	300 V, 20 A
Module width: 5 mm / 0.197 inch	
8 ... 9 mm / 0.31 ... 0.35 inch	



Dimensions (in mm)

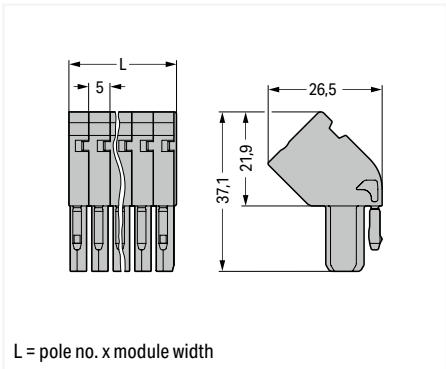

1-conductor female plug; angled; fits into carrier terminal blocks; codable; gray

Pole No.	Item No.	Pack. Unit
○ 1	769-101/022-000	200
○ 2	769-102/022-000	100
○ 3	769-103/022-000	50
○ 4	769-104/022-000	50
○ 5	769-105/022-000	50
○ 6	769-106/022-000	25
○ 7	769-107/022-000	25
○ 8	769-108/022-000	25
○ 9	769-109/022-000	25
○ 10	769-110/022-000	25
○ 11	769-111/022-000	20
○ 12	769-112/022-000	20
○ 13	769-113/022-000	10
○ 14	769-114/022-000	10
○ 15	769-115/022-000	10

1-conductor female plug; angled; fits into carrier terminal blocks; codable

1 green-yellow	769-101/022-016	200
----------------	-----------------	-----

- ① 500 V = rated voltage
6 kV = rated impulse voltage
3 = pollution degree (see Section 15)
- ② Current-carrying capacity curves upon request

Note:
According to EN 61984, pluggable connectors without a current interrupting capacity must not be mated or unmated when live or under load.

Approvals and corresponding ratings, visit www.wago.com

Accessories; for female plugs

Appropriate marking systems:
Mini-WSB/Mini-WSB Inline

Insulation stop; 0.08 ... 0.2 mm² "s" (0.14 mm² "f-st"); 5 pcs/strip

	white	769-470	200 (25)
--	-------	---------	----------

Insulation stop; 0.25 ... 0.5 mm²; 5 pcs/strip

	light gray	769-471	200 (25)
--	------------	---------	----------

Insulation stop; 0.75 ... 1 mm²; 5 pcs/strip

	dark gray	769-472	200 (25)
--	-----------	---------	----------

Protective warning marker; with black high-voltage symbol; for 5 terminal blocks

	yellow	280-415	100 (25)
--	--------	---------	----------

Operating lever; loose; for male and female connectors with CAGE CLAMP® connection

		769-434	2000 (100)
--	--	---------	------------

Test plug; with 500 mm cable; 2 mm Ø; max. 42 V

	red	210-136	50
--	-----	---------	----

Strain relief plate; gray

	1-pole	769-410	100 (25)
	2- ... 3-pole	769-411	100 (25)
	4- ... 5-pole	769-412	100 (25)

Strain relief plate; gray

	6- ... 9-pole	769-413	100 (25)
	10- ... 15-pole	769-414	100 (25)

Snap-on type strain relief housing; consists of strain relief support and housing

	5-pole	769-1605	25
--	--------	----------	----

Accessories; for female plugs

Appropriate marking systems:
Mini-WSB/Mini-WSB Inline

Mini-WSB Inline, plain; 1,700 WMB markers (5 mm)/reel; 5 ... 5.2 mm stretchable

	white	2009-145	1
--	-------	----------	---

Mini-WSB marking card; white; 10 strips with 10 markers/card; 5 mm wide markers

	plain	248-501	5
--	-------	---------	---

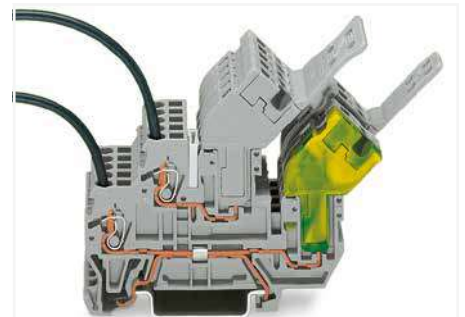

Angled female plugs provide reduced installation height.



1-conductor/1-pin double-deck carrier terminal block
1-conductor female plug, angled*
*1-conductor straight female plug is also possible!

Female Plug for Self-Assembly X-COM®-SYSTEM

4 mm²; 769 Series

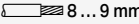
Technical Data	
0.08 ... 4 mm ²	28 ... 12 AWG
500 V / 6 kV / 3 ①	
I _N 32 A ②	
Terminal block width: 5 mm / 0.197 inch	
 8 ... 9 mm / 0.31 ... 0.35 inch	



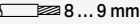





Technical Data	
0.08 ... 4 mm ²	28 ... 12 AWG
500 V / 6 kV / 3 ①	
I _N 32 A ②	
Terminal block width: 5 mm / 0.197 inch	
 8 ... 9 mm / 0.31 ... 0.35 inch	









Technical Data	
0.08 ... 4 mm ²	28 ... 12 AWG
500 V / 6 kV / 3 ①	
I _N 32 A ②	
Terminal block width: 5 mm / 0.197 inch	
 8 ... 9 mm / 0.31 ... 0.35 inch	









1-conductor end module; codable; can be commoned with miniature adjacent jumpers		
Color	Item No.	Pack. Unit
 gray	769-503	250
 blue	769-503/000-006	250
 green-yellow	769-503/000-016	250



2-conductor end module; codable; can be commoned with adjacent and staggered jumpers		
Color	Item No.	Pack. Unit
 gray	769-506	250
 blue	769-506/000-006	250
 green-yellow	769-506/000-016	250



1-conductor end module; angled; codable		
Color	Item No.	Pack. Unit
 gray	769-515	250
 blue	769-515/000-006	250
 green-yellow	769-515/000-016	250



1-conductor center module; codable; can be commoned with miniature adjacent jumpers		
Color	Item No.	Pack. Unit
 gray	769-502	250
 blue	769-502/000-006	250
 green-yellow	769-502/000-016	250

2-conductor center module; codable; can be commoned with adjacent and staggered jumpers		
Color	Item No.	Pack. Unit
 gray	769-505	250
 blue	769-505/000-006	250
 green-yellow	769-505/000-016	250

1-conductor center module; angled; codable		
Color	Item No.	Pack. Unit
 gray	769-513	250
 blue	769-513/000-006	250
 green-yellow	769-513/000-016	250



1-conductor base module; with integrated end plate; codable; can be commoned with miniature adjacent jumpers		
Color	Item No.	Pack. Unit
 gray	769-501	250
 blue	769-501/000-006	250
 green-yellow	769-501/000-016	250



2-conductor base module; with integrated end plate; codable; can be commoned with adjacent and staggered jumpers		
Color	Item No.	Pack. Unit
 gray	769-504	250
 blue	769-504/000-006	250
 green-yellow	769-504/000-016	250



1-conductor base module; angled; with integrated end plate; codable		
Color	Item No.	Pack. Unit
 gray	769-512	250
 blue	769-512/000-006	250
 green-yellow	769-512/000-016	250



Accessories; item-specific			
Adjacent jumper; insulated; I _N 24 A			
	gray	769-402	100 (25)

Accessories; item-specific			
Adjacent jumper; insulated; I _N = I _N terminal block			
	gray	280-402	200 (25)

Locking Lever; for 1-pole female plugs			
	gray	769-428	100 (25)
	orange	769-429	100 (25)

Locking Lever; for 1-pole female plugs			
	gray	769-428	100 (25)
	orange	769-429	100 (25)

Locking lever; for female plugs with 2 poles and more			
	gray	769-431	100 (25)
	orange	769-430	100 (25)



Locking lever; for female plugs with 2 poles and more			
	gray	769-431	100 (25)
	orange	769-430	100 (25)

Accessories; for female plugs

Insulation stop; 0.08 ... 0.2 mm ² "s" (0.14 mm ² "f-st"); 5 pcs/strip			
	white	769-470	200 (25)



Appropriate marking systems: Mini-WSB/Mini-WSB Inline

Protective warning marker; with black high-voltage symbol; for 5 terminal blocks			
	yellow	280-415	100 (25)

Strain relief plate; gray			
	1-pole	769-410	100 (25)
	2- ... 3-pole	769-411	100 (25)
	4- ... 5-pole	769-412	100 (25)

Insulation stop; 0.25 ... 0.5 mm ² ; 5 pcs/strip			
	light gray	769-471	200 (25)

Operating lever; loose; for male and female connectors with CAGE CLAMP® connection			
		769-434	2000 (100)

Strain relief plate; gray			
	6- ... 9-pole	769-413	100 (25)
	10- ... 15-pole	769-414	100 (25)

Insulation stop; 0.75 ... 1 mm ² ; 5 pcs/strip			
	dark gray	769-472	200 (25)

Test plug; with 500 mm cable; 2 mm Ø; max. 42 V			
	red	210-136	50

- ❶ 500 V = rated voltage
6 kV = rated impulse voltage
3 = pollution degree
(see Section 15)
 - ❷ Current-carrying capacity curves upon request
- Note:**
According to EN 61984, pluggable connectors without a current interrupting capacity must not be mated or unmated when live or under load.
- Approvals and corresponding ratings, visit www.wago.com

Customizing Modular Female Plugs
WAGO's modular X-COM®-SYSTEM female plugs can be customized for applications requiring varying numbers of poles (e.g., when designing prototypes).

- Modules and Pole Numbers**
A customized X-COM®-SYSTEM female plug consists of:
- One base module with an integrated end plate
 - Up to 13 center modules (corresponding to a 15-pole female plug = maximum pole number)
 - One end module

Intended Use
According to EN 61984, pluggable connectors without a current interrupting capacity must not be mated or unmated when live or under load.

Assembly
The appropriate mounting tool shall be used in order to guarantee that the individual modules are properly attached to each other without damaging the locking latches.



End module



Center module



Base module

Example: 5-Pole, 1-Conductor Female Plug



- Base module with integrated end plate
769-501/000-016
- Center module
769-502/000-006
- Center modules
769-502
- End module
769-503

Pre-Assembled 1-Conductor Female Plug X-COM®-SYSTEM 4 mm²; 769 Series

Technical Data	
0.08 ... 4 mm ²	28 ... 12 AWG
500 V / 6 kV / 3 ①	
I _N 32 A ②	
Module width: 5 mm / 0.197 inch	
8 ... 9 mm / 0.31 ... 0.35 inch	

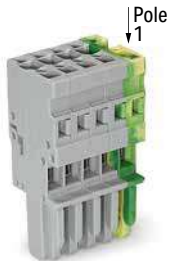

Technical Data	
0.08 ... 4 mm ²	28 ... 12 AWG
500 V / 6 kV / 3 ①	
I _N 32 A ②	
Module width: 5 mm / 0.197 inch	
8 ... 9 mm / 0.31 ... 0.35 inch	



Technical Data	
0.08 ... 4 mm ²	28 ... 12 AWG
500 V / 6 kV / 3 ①	
I _N 32 A ②	
Module width: 5 mm / 0.197 inch	
8 ... 9 mm / 0.31 ... 0.35 inch	

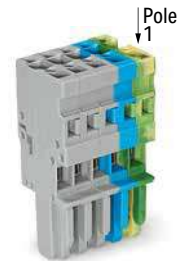

1-conductor female plug; with ground base module (green-yellow); fits into carrier terminal blocks or male connectors; codable; can be commoned with miniature adjacent jumpers

Pole No.	Item No.	Pack. Unit
3	769-103/000-036	25
4	769-104/000-036	25
5	769-105/000-036	20
6	769-106/000-036	10
7	769-107/000-036	10
8	769-108/000-036	10
9	769-109/000-036	10
10	769-110/000-036	10
11	769-111/000-036	5
12	769-112/000-036	5
13	769-113/000-036	5
14	769-114/000-036	5
15	769-115/000-036	5

1-conductor female plug; with ground end module (green-yellow); fits into carrier terminal blocks or male connectors; codable; can be commoned with miniature adjacent jumpers

Pole No.	Item No.	Pack. Unit
3	769-103/000-037	25
4	769-104/000-037	25
5	769-105/000-037	20
6	769-106/000-037	10
7	769-107/000-037	10
8	769-108/000-037	10
9	769-109/000-037	10
10	769-110/000-037	10
11	769-111/000-037	5
12	769-112/000-037	5
13	769-113/000-037	5
14	769-114/000-037	5
15	769-115/000-037	5

1-conductor female plug; with ground base module (green-yellow); fits into carrier terminal blocks or male connectors; codable; can be commoned with miniature adjacent jumpers

Pole No.	Item No.	Pack. Unit
3	769-103/000-038	25
4	769-104/000-038	25
5	769-105/000-038	20
6	769-106/000-038	10
7	769-107/000-038	10
8	769-108/000-038	10
9	769-109/000-038	10
10	769-110/000-038	10
11	769-111/000-038	5
12	769-112/000-038	5
13	769-113/000-038	5
14	769-114/000-038	5
15	769-115/000-038	5

Accessories; for female plugs

Insulation stop; 0.08 ... 0.2 mm² "s" (0.14 mm² "f-st"); 5 pcs/strip

white	769-470	200 (25)
-------	---------	----------

Insulation stop; 0.25 ... 0.5 mm²; 5 pcs/strip

light gray	769-471	200 (25)
------------	---------	----------

Insulation stop; 0.75 ... 1 mm²; 5 pcs/strip

dark gray	769-472	200 (25)
-----------	---------	----------

Protective warning marker; with black high-voltage symbol; for 5 terminal blocks

yellow	280-415	100 (25)
--------	---------	----------

Adjacent jumper; insulated; I_N 24 A

gray	769-402	100 (25)
------	---------	----------

Jumper cover; for 1-conductor female plugs; for 5 poles

gray	769-436	100 (25)
------	---------	----------

Appropriate marking systems: Mini-WSB/Mini-WSB Inline

Test plug; with 500 mm cable; 2 mm Ø; max. 42 V

red	210-136	50
-----	---------	----

Strain relief plate; gray

2- ... 3-pole	769-411	100 (25)
4- ... 5-pole	769-412	100 (25)

Strain relief plate; gray

6- ... 9-pole	769-413	100 (25)
10- ... 15-pole	769-414	100 (25)

Snap-on type strain relief housing; consists of strain relief support and housing

5-pole	769-1605	25
--------	----------	----

Operating lever; loose; for male and female connectors with CAGE CLAMP® connection

	769-434	2000 (100)
--	---------	------------

Mini-WSB Inline, plain; 1,700 WMB markers (5 mm)/reel; 5 ... 5.2 mm stretchable

white	2009-145	1
-------	----------	---

Mini-WSB marking card; white; 10 strips with 10 markers/card; 5 mm wide markers

plain	248-501	5
-------	---------	---

7

Technical Data0.08 ... 4 mm² | 28 ... 12 AWG

500 V / 6 kV / 3 ①

I_N 32 A ②

Module width: 5 mm / 0.197 inch

 8 ... 9 mm / 0.31 ... 0.35 inch

- ① 500 V = rated voltage
6 kV = rated impulse voltage
3 = pollution degree
(see Section 15)
 - ② Current-carrying capacity curves upon request
- Snap-on type strain relief housing, see page 452

Note:

According to EN 61984, pluggable connectors without a current interrupting capacity must not be mated or unmated when live or under load.

Approvals and corresponding ratings, visit www.wago.com

1-conductor female plug; with ground end module (green-yellow); fits into carrier terminal blocks or male connectors; codable; can be commoned with miniature adjacent jumpers

Pole No.	Item No.	Pack. Unit
3	769-103/000-039	25
4	769-104/000-039	25
5	769-105/000-039	20
6	769-106/000-039	10
7	769-107/000-039	10
8	769-108/000-039	10
9	769-109/000-039	10
10	769-110/000-039	10
11	769-111/000-039	5
12	769-112/000-039	5
13	769-113/000-039	5
14	769-114/000-039	5
15	769-115/000-039	5

Strain Relief Housing X-COM®-SYSTEM; for Female Plugs and Male Connectors with CAGE CLAMP® Connection 769 Series

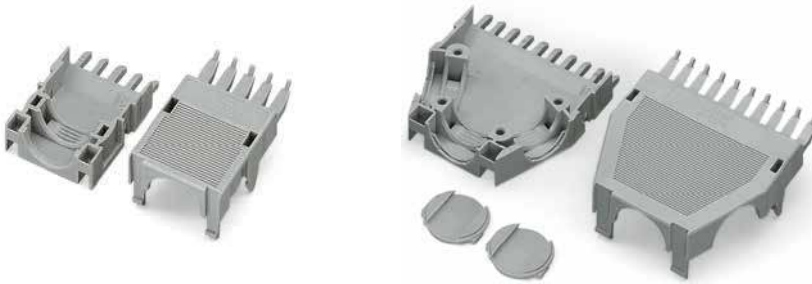

Dimensions (in mm)

Dimensions for strain relief housings

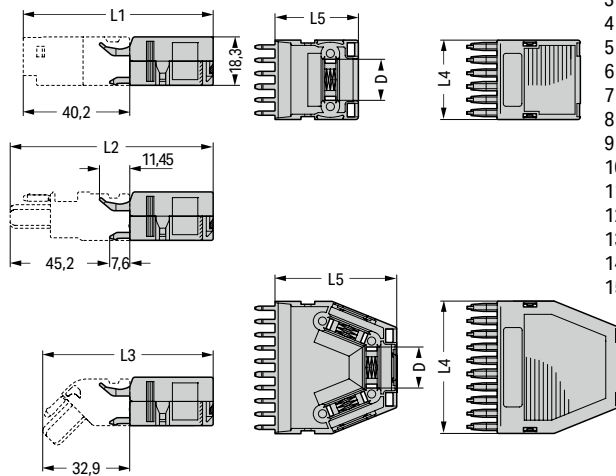

pole no.	L1	L2	L3	L4	L5	D
2	71.7	76.7	64.4	10	31.5	5
3	71.7	76.7	64.4	15	31.5	9.7
4	71.7	76.7	64.4	20	31.5	14
5	71.7	76.7	64.4	25	31.5	14
6	71.7	76.7	64.4	30	31.5	15.5
7	77.7	81.7	69.4	35	36.5	15.5
8	86.2	91.2	78.9	40	46	15.5
9	86.2	91.2	78.9	45	46	15.5
10	86.2	91.2	78.9	50	46	15.5
11	86.2	91.2	78.9	55	46	15.5
12	86.2	91.2	78.9	60	46	15.5
13	86.2	91.2	78.9	65	46	15.5
14	86.2	91.2	78.9	70	46	15.5
15	86.2	91.2	78.9	75	46	15.5

Strain relief housing; consists of strain relief support and housing with 1 cable outlet (rear side), 2- to 5-pole only suitable for cable ties (not offered by WAGO); gray

Polzahl	Bestellnr.	VPE
○ 2	769-1602	100
○ 3	769-1603	100
○ 4	769-1604	100
○ 5	769-1605	50

Strain relief housing; consists of strain relief support and housing with 1 cable outlet; gray

Polzahl	Bestellnr.	VPE
○ 6	769-1606	100
○ 7	769-1607	100

Strain relief housing; consists of strain relief support and housing with 2 cable outlets, 1 cover; gray

○ 8	769-1608	50
○ 9	769-1609	50

Strain relief housing; consists of strain relief support and housing with 3 cable outlets, 2 covers; gray

○ 10	769-1610	50
○ 11	769-1611	25
○ 12	769-1612	25
○ 13	769-1613	25
○ 14	769-1614	25
○ 15	769-1615	25

Accessories; item-specific

WSB Quick Marking System; white; 10 strips with 10 markers/card; for 5 ... 17.5 mm terminal block width

	plain	209-501	5
--	-------	---------	---

Accessories; item-specific

Cable clamp; for strain relief

	6 or more poles	209-174	25
--	-----------------	---------	----

Mounting screw; for cable clamp

	6 or more poles	209-173	50
--	-----------------	---------	----

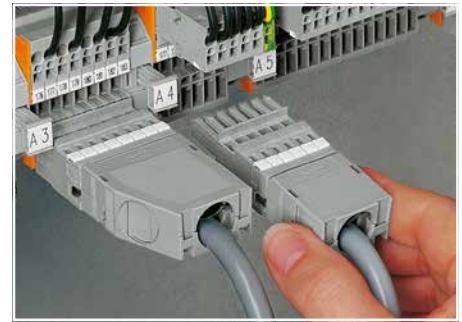

Application:
Strain relief housings for 769 Series

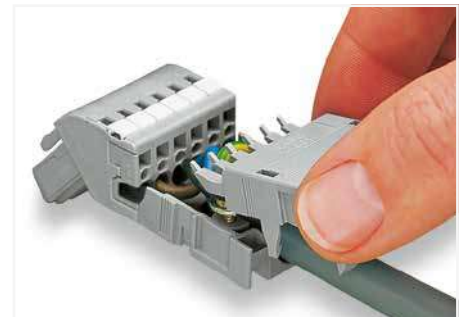

Snapping on a strain relief housing.



Strain relief housing; consists of strain relief support and housing; 6-pole and 1-conductor female plug; angled; 6-pole

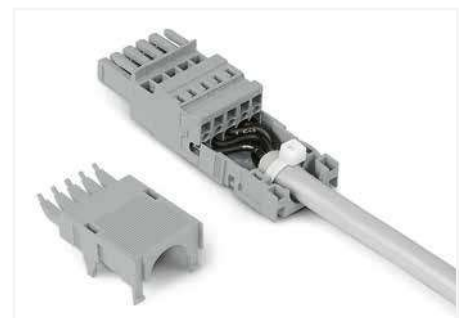

2- to 5-pole strain relief housings feature one cable outlet (rear side).
6- to 7-pole strain relief housings feature one cable outlet
8- to 9-pole strain relief housings feature two cable outlets and one cover.
10- to 16-pole strain relief housings feature three cable outlets and two covers.

1-Conductor/1-Pin and 2-Pin Carrier Terminal Blocks and 1-Conductor Female Plugs X-COM®-SYSTEM Current-Carrying Capacity Curves

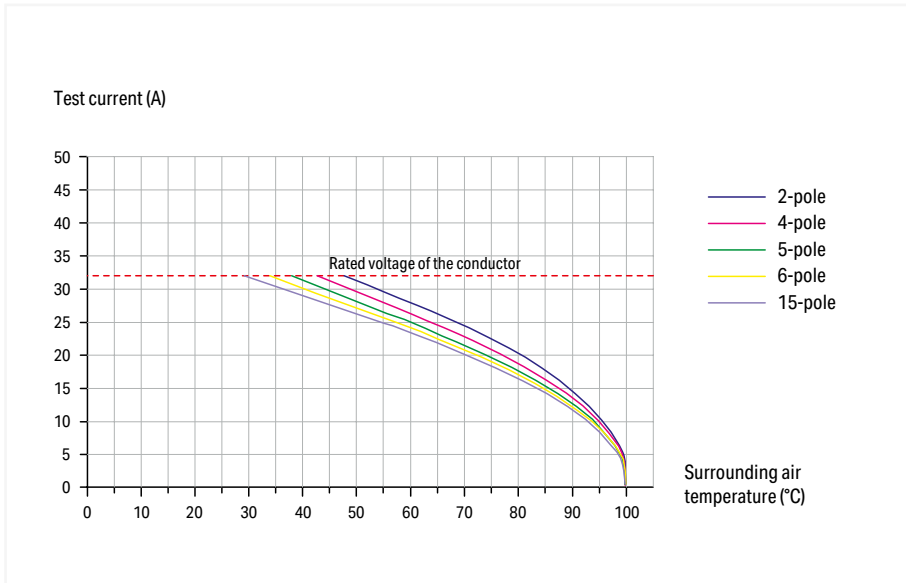

1-conductor/1-pin carrier terminal block (769-176)
Conductor cross section: 4 mm² (12 AWG)

1-conductor female plugs (769-102 to 769-115)
Conductor cross section: 4 mm² (12 AWG)
Conductor loop length: 1 m

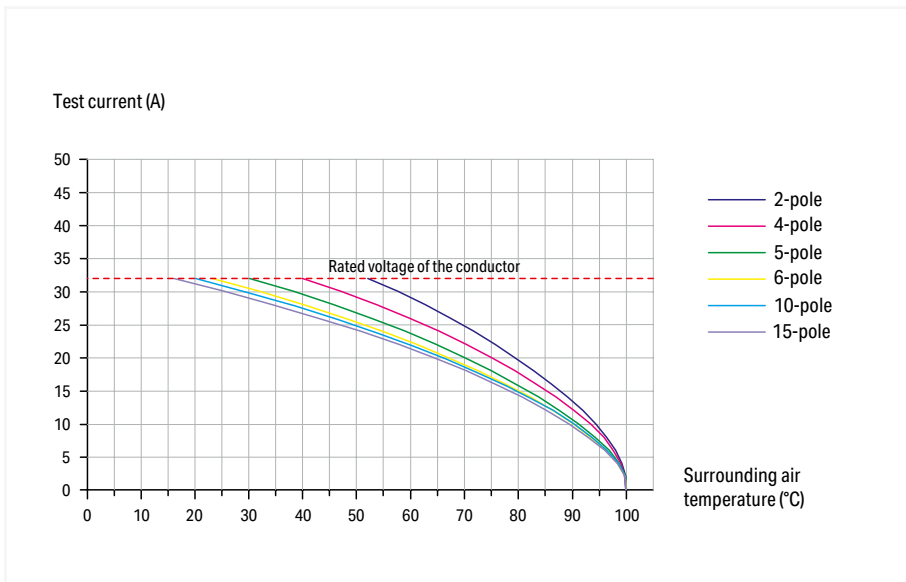

2-pin carrier terminal block (769-156)

1-conductor female plugs (769-102 to 769-115)
Conductor cross section: 4 mm² (12 AWG)
Conductor loop length: 1 m

2-Conductor/2-Pin and 4-Pin Carrier Terminal Blocks and 1-Conductor Female Plugs X-COM®-SYSTEM Current-Carrying Capacity Curves

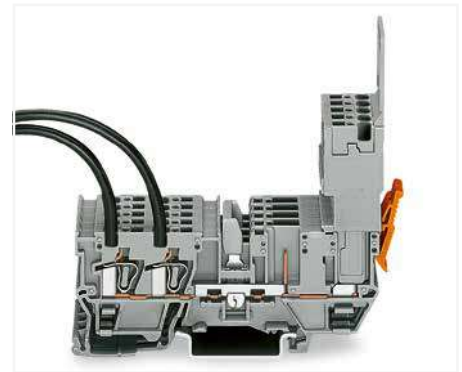
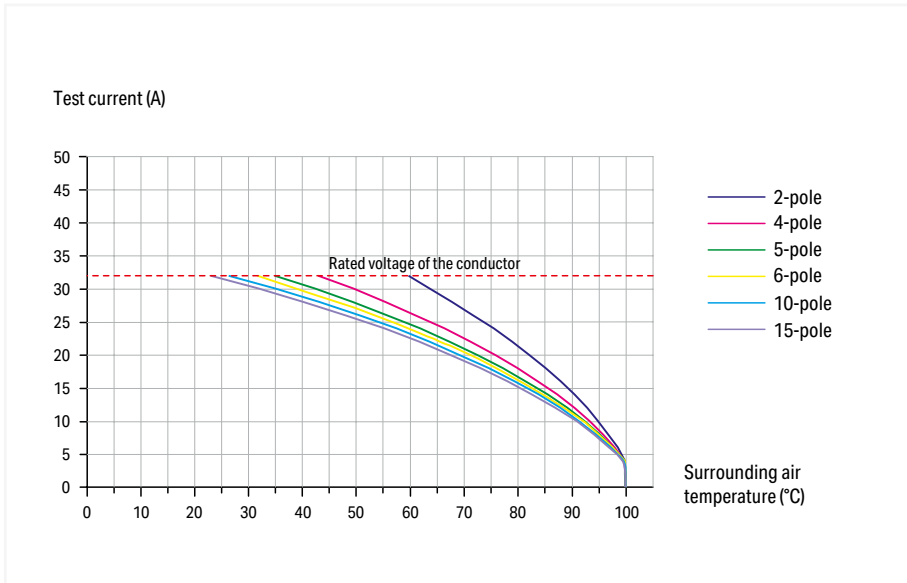

2-conductor/2-pin carrier terminal block (769-171)
Conductor cross section: 4 mm² (12 AWG)

1-conductor female plugs (769-102 to 769-115)
Conductor cross section: 4 mm² (12 AWG)
Conductor loop length: 1 m

7

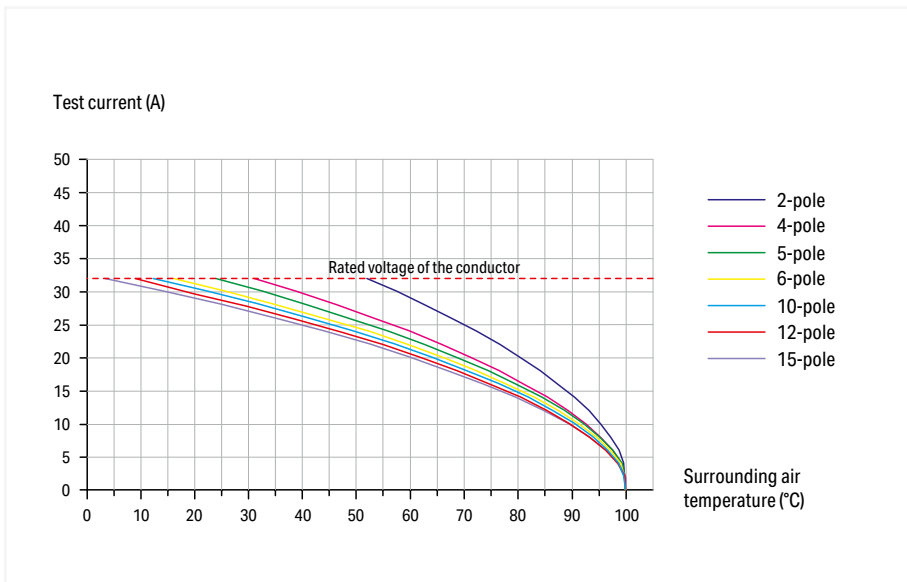

4-pin carrier terminal block (769-151)

1-conductor female plugs (769-102 to 769-115)
Conductor cross section: 4 mm² (12 AWG)
Conductor loop length: 1 m

Male Connectors; with CAGE CLAMP® Connection and 1-Conductor Female Plugs X-COM®-SYSTEM Current-Carrying Capacity Curves

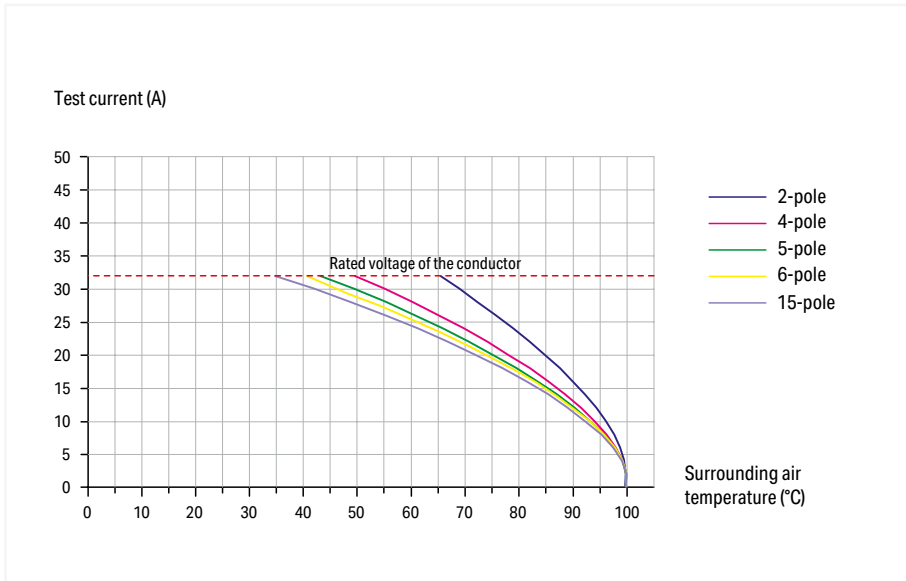

Male connectors with CAGE CLAMP® connection (769-602 to 769-615)
Conductor cross section: 4 mm² (12 AWG)

1-conductor female plugs (769-102 to 769-115)
Conductor cross section: 4 mm² (12 AWG)
Conductor loop length: 1 m



Male Headers with Straight/Angled Solder Pins and 1-Conductor Female Plugs

X-COM®-SYSTEM

Current-Carrying Capacity Curves

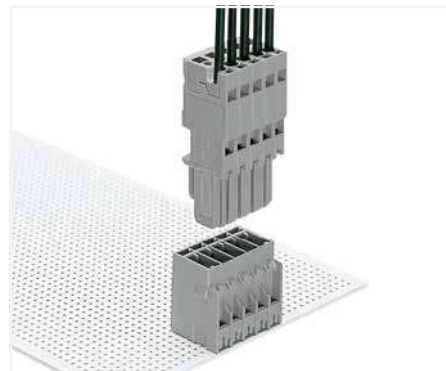
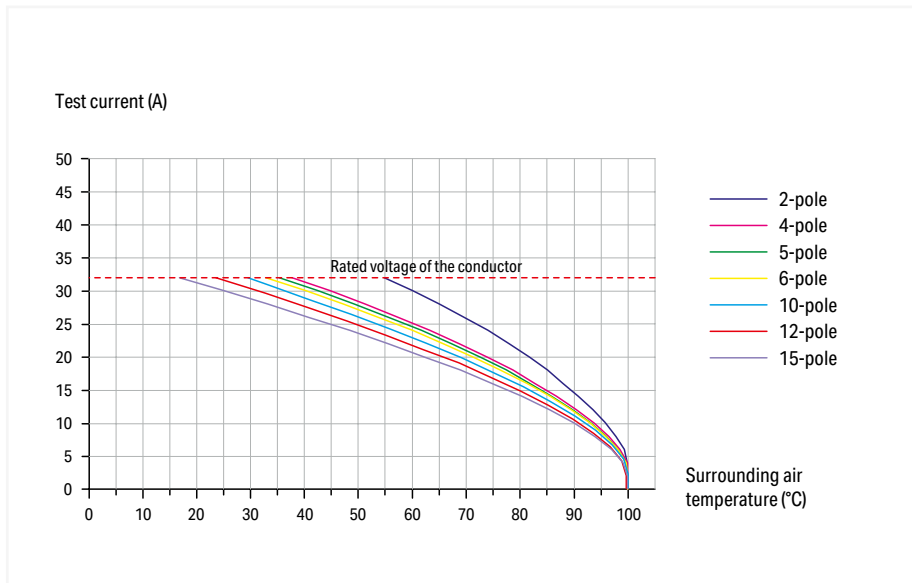

Male headers with straight solder pins (769-632 to 769-645)

1-conductor female plugs (769-102 to 769-115)
 Conductor cross section: 4 mm² (12 AWG)
 Conductor loop length: 1 m

7

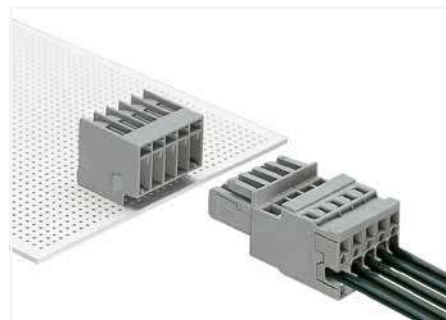
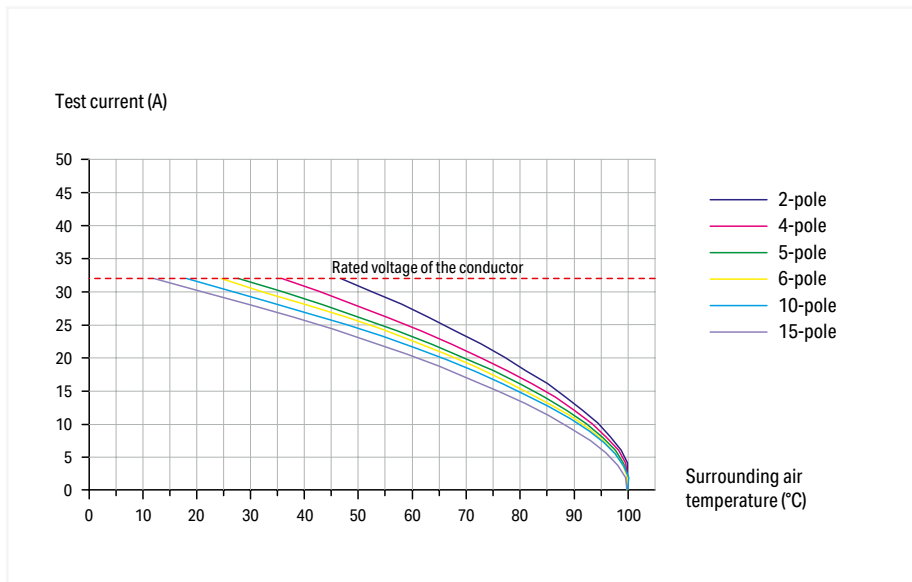

Male headers with angled solder pins (769-662 to 769-675)



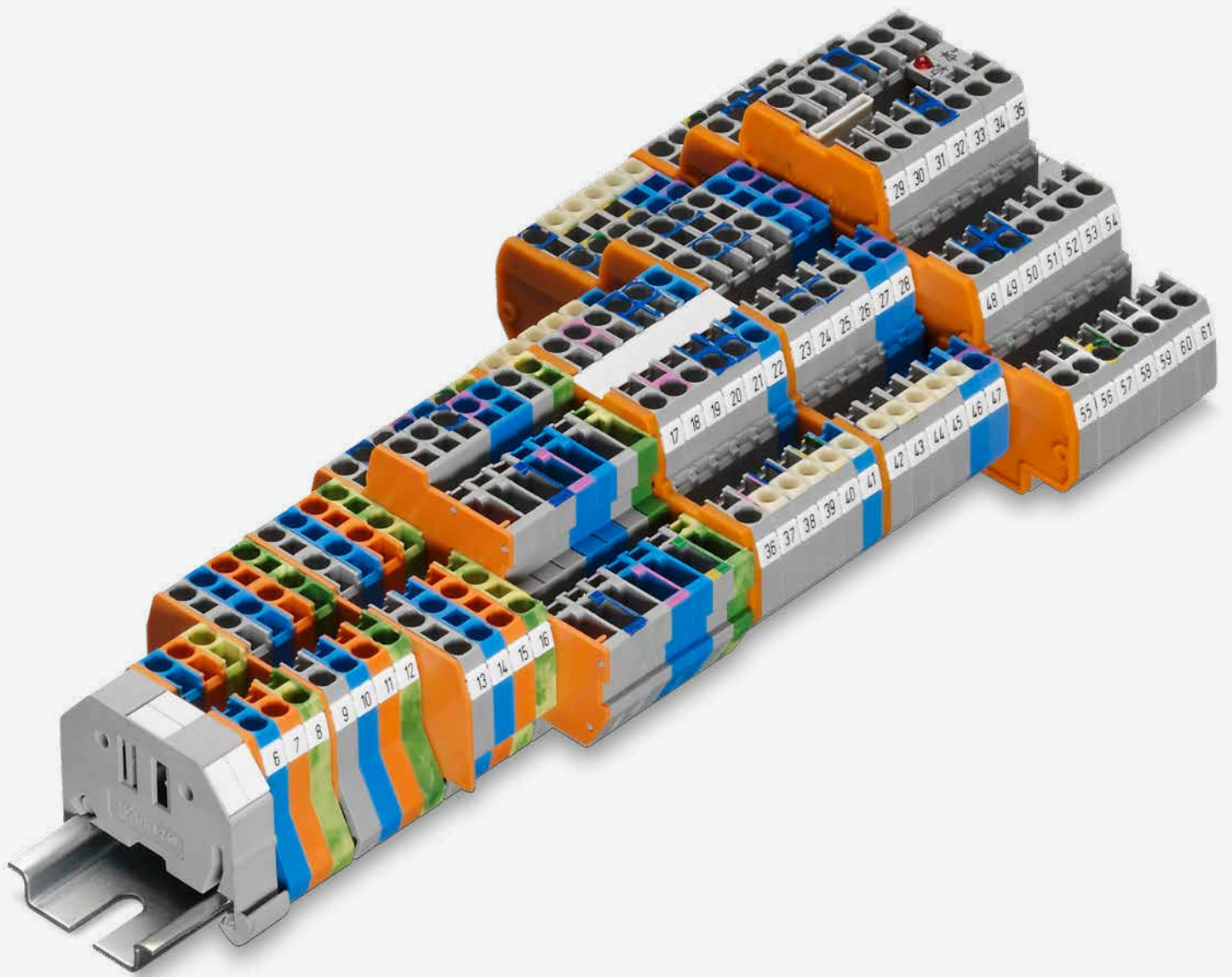



1-conductor female plugs (769-102 to 769-115)
 Conductor cross section: 4 mm² (12 AWG)
 Conductor loop length: 1 m



WAGO Rail-Mount Terminal Blocks Mini
WAGO Rail-Mount Terminal Blocks Compact

WAGO Rail-Mount Terminal Blocks Mini

WAGO Rail-Mount Terminal Blocks Compact

			Page
	Through, Ground Conductor and Ex Terminal Blocks for DIN-35 and DIN-15 Rails 0.08 ... 2.5 mm ² (28 ... 12 AWG)	264 Series	504
	Through, Ground Conductor and Ex Terminal Blocks for DIN-35 and DIN-15 Rails 0.08 ... 2.5 (4 "f-st") mm ² (28 ... 12 AWG)	870 Series	508
	Multilevel Rail-Mount Terminal Blocks 0.08 ... 2.5 (4 "f-st") mm ² (28 ... 12 AWG)	870 Series	510
	Multilevel Diode and LED Terminal Blocks 0.08 ... 2.5 (4 "f-st") mm ² (28 ... 12 AWG)	870 Series	514
	Sensor and Actuator Terminal Blocks 0.08 ... 2.5 mm ² (28 ... 12 AWG)	270 Series	521
	Accessories for Rail-Mount Terminal Blocks		513

Rail-Mount Terminal Blocks Mini; for DIN-15 and DIN-35 Rails

264 Series

Description and Installation

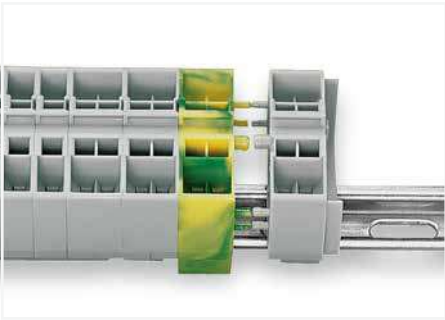

Quick assembly keys prevent reverse mounting.

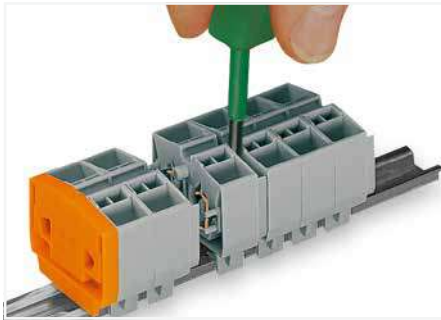

Separate terminal strip and slide individual terminal block laterally.



Remove terminal block from the DIN-rail with a levering action.



Commoning with comb-style jumper bar.

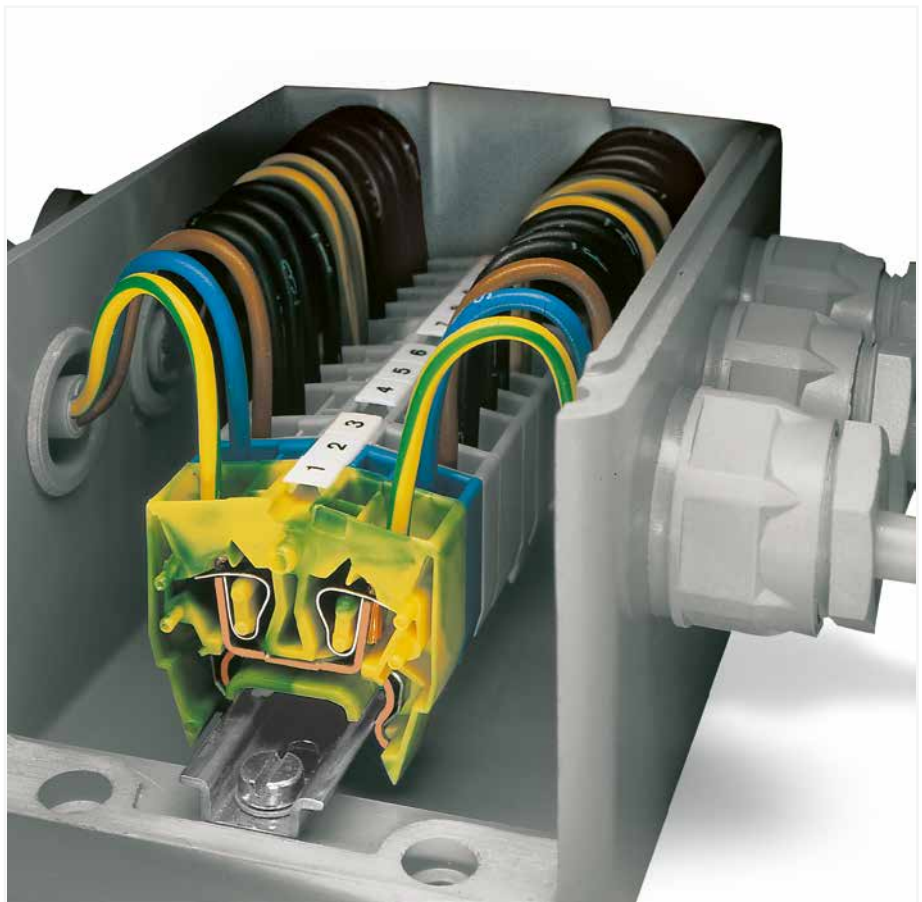

8

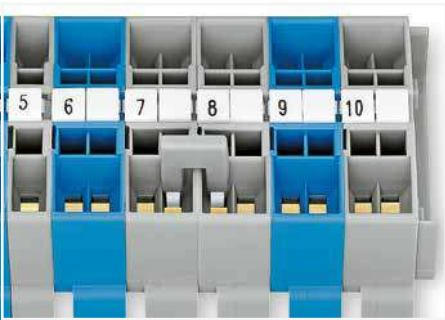

Commoning with comb-style jumper bar.

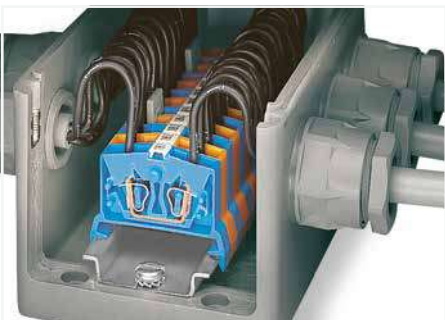

Easy-to-use miniature blocks that require minimal enclosure space.



Combining 2- and 4-conductor terminal blocks.



Marking via Mini-WSB Quick Marking System.



CAGE CLAMP® terminates the following copper conductors: solid "s"



stranded "st"



fine-stranded "f-st", also with tinned single strands



CAGE CLAMP® termination:
Inserting a conductor.
With ferruled conductors, it is necessary to use a terminal block one size smaller than the conductor's nominal cross section.

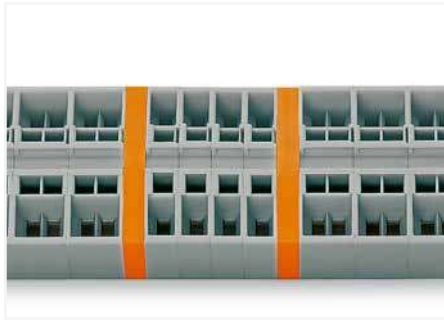

Separating groups via intermediate plates.

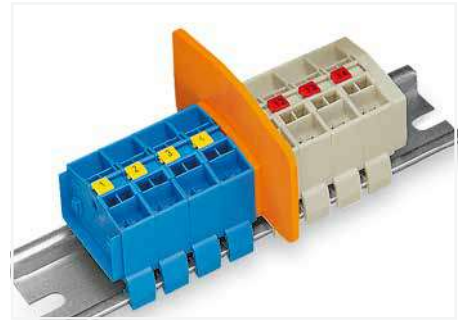

Ex e/Ex i separator plate for miniature rail-mount terminal blocks

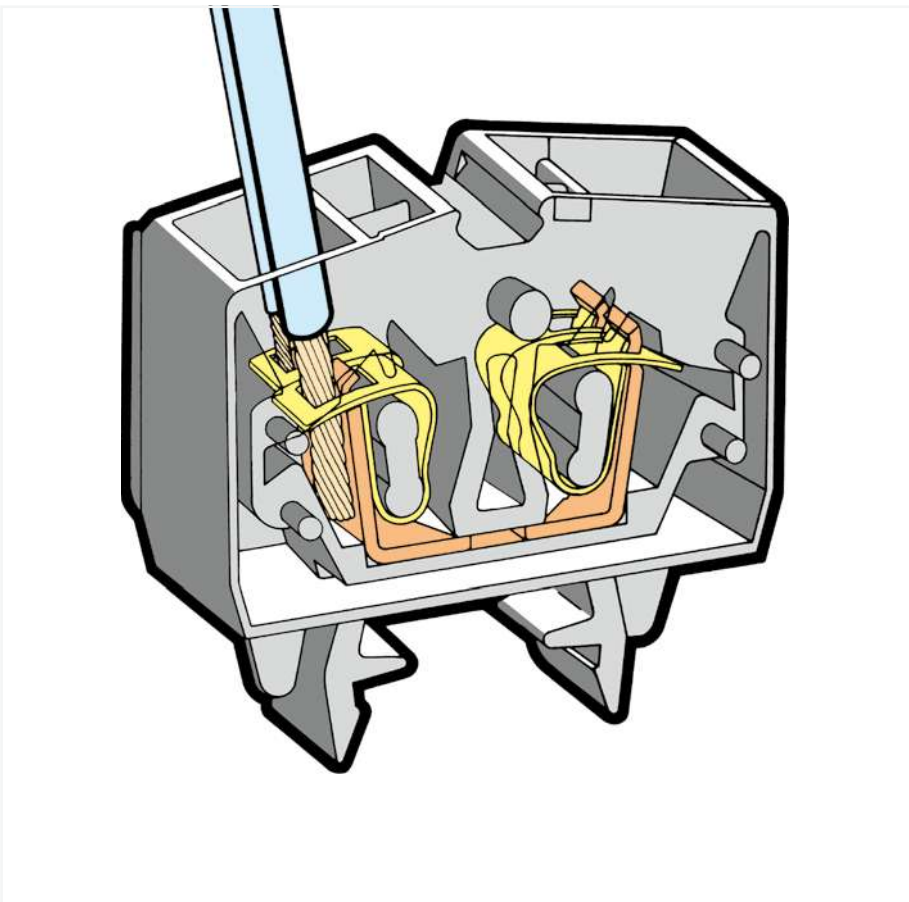

Testing by touch contact to the CAGE CLAMP® spring (limited to 0.5 A and 48 V test voltage) – test pins are not protected against accidental contact.



Testing via CAGE CLAMP® on the current bar (max. nominal current: 6 A) – CAGE CLAMP® clamps individual test contacts. The maximum test voltage is 400 V.



Marking with T-marker tag (209-290).



fine-stranded, tip-bonded



fine-stranded, with ferrule (gastight crimped)



fine-stranded, with pin terminal (gastight crimped)

Miniature Through/Ground Conductor and Ex Terminal Block; for DIN-35 Rail

2.5 mm²; 264 Series

Technical Data	
0.08 ... 2.5 mm ²	28 ... 12 AWG*
800 V / 8 kV / 3 ①	300 V, 20 A ②
I _N 24 A	600 V, 20 A ③
Terminal block width: 6 mm / 0.236 inch	
8 ... 9 mm / 0.31 ... 0.35 inch	



Technical Data	
0.08 ... 2.5 mm ²	28 ... 12 AWG*
800 V / 8 kV / 3 ①	300 V, 20 A ②
I _N 24 A	600 V, 20 A ③
Terminal block width: 10 mm / 0.394 inch	
8 ... 9 mm / 0.31 ... 0.35 inch	

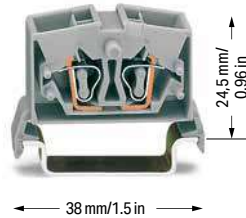

2-conductor miniature through terminal block; for DIN-35 rail		
Color	Item No.	Pack. Unit
gray	264-711	100
blue	264-714 ②	100
orange	264-716	100
light gray ③	264-125 ③	100

Accessories; item-specific		
Alternate comb-style jumper bar; insulated; I _N = I _N of terminal block		

2-way	281-492	100 (25)
-------	---------	----------

Test plug module; snaps together; 6 mm wide		
gray	249-136	100 (25)

4-conductor miniature through terminal block; for DIN-35 rail		
Color	Item No.	Pack. Unit
gray	264-731	100
blue	264-734 ②	100
orange	264-736	100
light gray ③	264-225 ③	100

Accessories; item-specific		
Alternate comb-style jumper bar; insulated; I _N = I _N of terminal block		

2-way	280-492	200 (25)
-------	---------	----------

Test plug module; snaps together; 10 mm wide		
gray	249-139	100 (25)

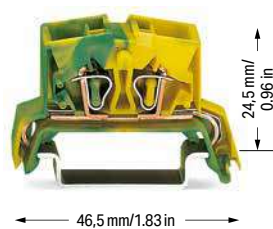

4-conductor miniature ground terminal block; for DIN-35 rail		
Color	Item No.	Pack. Unit
green-yellow	264-737	100
green-yellow ③	264-737/999-950 ③	100

Accessories; item-specific		
Alternate comb-style jumper bar; insulated; I _N = I _N of terminal block		

2-way	280-492	200 (25)
-------	---------	----------

Test plug module; snaps together; 10 mm wide		
gray	249-139	100 (25)

*12 AWG: THHN, THWN

- ① 800 V = rated voltage
8 kV = rated impulse voltage
3 = pollution degree (see Section 15)
- ② Terminal blocks with a blue insulated housing are suitable for Ex i applications.
- ③ Terminal blocks with an Ex mark are suitable for Ex e II applications.
0.5 ... 2.5 mm² / 20 ... 12 AWG*
690 V; 23 A (see Section 15)

See application notes for:
Alternate comb-style jumper bar, page 426
Test plug module, page 420
Mini-WSB marking system, page 684

Approvals and corresponding ratings, visit www.wago.com

Accessories; 264 Series

Appropriate marking systems:
Mini-WSB/Mini-WSB Inline/T-marker tag

End and intermediate plate; 4 mm thick			
orange	264-369	25	
gray	264-368	25	
light gray	264-370	25	

Ex e/Ex i separator; orange; 4 mm thick			
66 mm	264-367	25	

Comb-style jumper bar; insulated; reduces maximum conductor size to 1.5 mm ² ; I _N 16 A; gray			
2-way	264-402	200 (25)	

Operating tool; insulated		
2-way	280-432	1

Test plug; with 500 mm cable; 2 mm Ø; max. 42 V		
red	210-136	50

Mini-WSB Inline, plain; 1,700 WMB markers (5 mm)/reel; 5 ... 5.2 mm stretchable		
white	2009-145	1

Mini-WSB marking card; white; 10 strips with 10 markers/card; 5 mm wide markers		
plain	248-501	5

Screwless end stop; for DIN-35 rail; 6 mm wide		
gray	249-116	100 (25)

Steel DIN-rail; per EN 60715; 35 x 7.5 mm; 1 mm thick; 2 m long			
slotted	210-112	10 (1)	
unslotted	210-113	10	

Aluminum DIN-rail; similar to EN 60715; 35 x 8.2 mm; 1.6 mm thick; 2 m long			
unslotted	210-196	10	

Miniature Through/Ground Conductor and Ex Terminal Block; for DIN-15 Rail

2.5 mm²; 264 Series

Technical Data	
0.08 ... 2.5 mm ²	28 ... 12 AWG*
800 V / 8 kV / 3 ❶	300 V, 20 A ❷
I _N 24 A	600 V, 20 A ❸
Terminal block width: 6 mm / 0.236 inch	
8 ... 9 mm / 0.31 ... 0.35 inch	

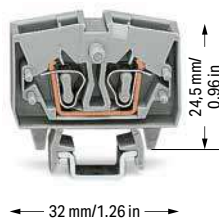

2-conductor miniature through terminal block; for DIN-15 rail		
Color	Item No.	Pack. Unit
gray	264-701	100
blue	264-704 ❷	100
orange	264-706	100
light gray ❸	264-120 ❸	100

Accessories; item-specific		
Alternate comb-style jumper bar; insulated; I _N = I _N of terminal block		
2-way	281-492	100 (25)



Test plug module; snaps together; 6 mm wide		
gray	249-136	100 (25)



Technical Data	
0.08 ... 2.5 mm ²	28 ... 12 AWG*
800 V / 8 kV / 3 ❶	300 V, 20 A ❷
I _N 24 A	600 V, 20 A ❸
Terminal block width: 10 mm / 0.394 inch	
8 ... 9 mm / 0.31 ... 0.35 inch	

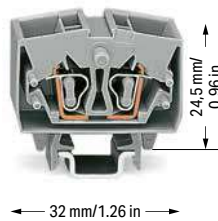

4-conductor miniature through terminal block; for DIN-15 rail		
Color	Item No.	Pack. Unit
gray	264-721	100
blue	264-724 ❷	100
orange	264-726	100
light gray ❸	264-220 ❸	100

Accessories; item-specific		
Alternate comb-style jumper bar; insulated; I _N = I _N of terminal block		
2-way	280-492	200 (25)



Test plug module; snaps together; 10 mm wide		
gray	249-139	100 (25)



4-conductor miniature ground terminal block; for DIN-15 rail		
Color	Item No.	Pack. Unit
green-yellow	264-727	100
green-yellow ❸	264-727/999-950 ❸	100

Accessories; item-specific		
Alternate comb-style jumper bar; insulated; I _N = I _N of terminal block		
2-way	280-492	200 (25)



Test plug module; snaps together; 10 mm wide		
gray	249-139	100 (25)



*12 AWG: THHN, THWN

- ❶ 800 V = rated voltage
8 kV = rated impulse voltage
3 = pollution degree
(see Section 15)
- ❷ Terminal blocks with a blue insulated housing are suitable for Ex i applications.
- ❸ Terminal blocks with an Ex mark are suitable for Ex e II applications.
0.5 ... 2.5 mm² / 20 ... 12 AWG*
690 V; 23 A
(see Section 15)

See application notes for:
Alternate comb-style jumper bar, page 426
Test plug module, page 420
Mini-WSB marking system, page 684

Approvals and corresponding ratings,
visit www.wago.com

Accessories; 264 Series

Appropriate marking systems:
Mini-WSB/Mini-WSB Inline/T-marker tag

End and intermediate plate; 4 mm thick			
	orange	264-369	25
	gray	264-368	25
	light gray	264-370	25

Ex e/Ex i separator; orange; 4 mm thick			
	66 mm	264-367	25

Comb-style jumper bar; insulated; reduces maximum conductor size to 1.5 mm ² ; I _N 16 A; gray			
	2-way	264-402	200 (25)

Operating tool; insulated			
	2-way	280-432	1

Test plug; with 500 mm cable; 2 mm Ø; max. 42 V			
	red	210-136	50

Mini-WSB Inline, plain; 1,700 WMB markers (5 mm)/reel; 5 ... 5.2 mm stretchable			
	white	2009-145	1

Mini-WSB marking card; white; 10 strips with 10 markers/card; 5 mm wide markers			
	plain	248-501	5

Screwless end stop; for DIN-15 rail; 6 mm wide			
	gray	249-101	25

Steel DIN-rail; per EN 60715; 15 x 5.5 mm; 1 mm thick; 2 m long			
	slotted	210-111	10 (1)
	unslotted	210-295	10 (1)

Aluminum DIN-rail; similar to EN 60715; 15 x 5.5 mm; 1 mm thick; 2 m long			
	unslotted	210-296	1

Rail-Mount Terminal Blocks Compact; for DIN-15 and DIN-35 Rails

870 Series

Description and Installation

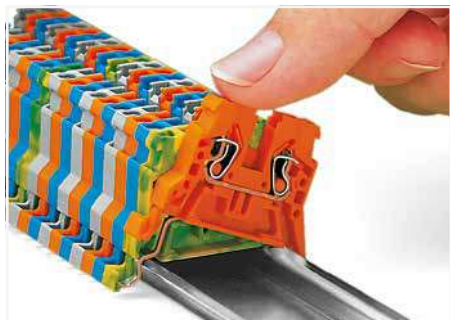

Snapping a rail-mount terminal block onto DIN-35 rail.

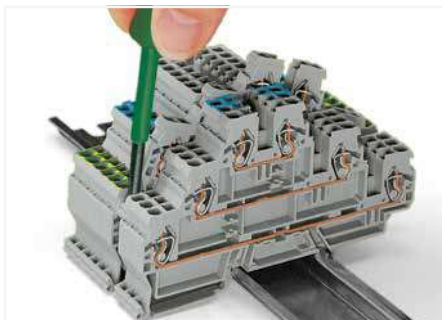

Removing a terminal block from the assembly.



Inserting insulation stops into conductor entry holes of terminal strip.



Push jumper bars down firmly until fully inserted. When using multipole bars, push alternately on the right and then left side until installed.

Push-in type jumper bars 1-3-5-7 or 1-4-7 are available upon request.

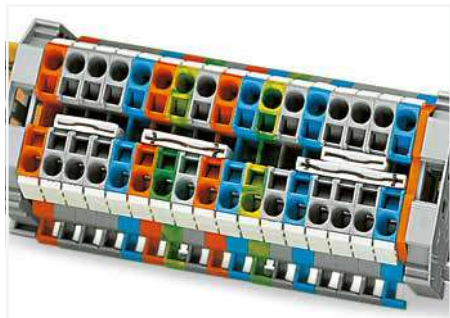

Commoning with push-in type jumper bars: Two parallel jumper slots are accommodated in one terminal block.

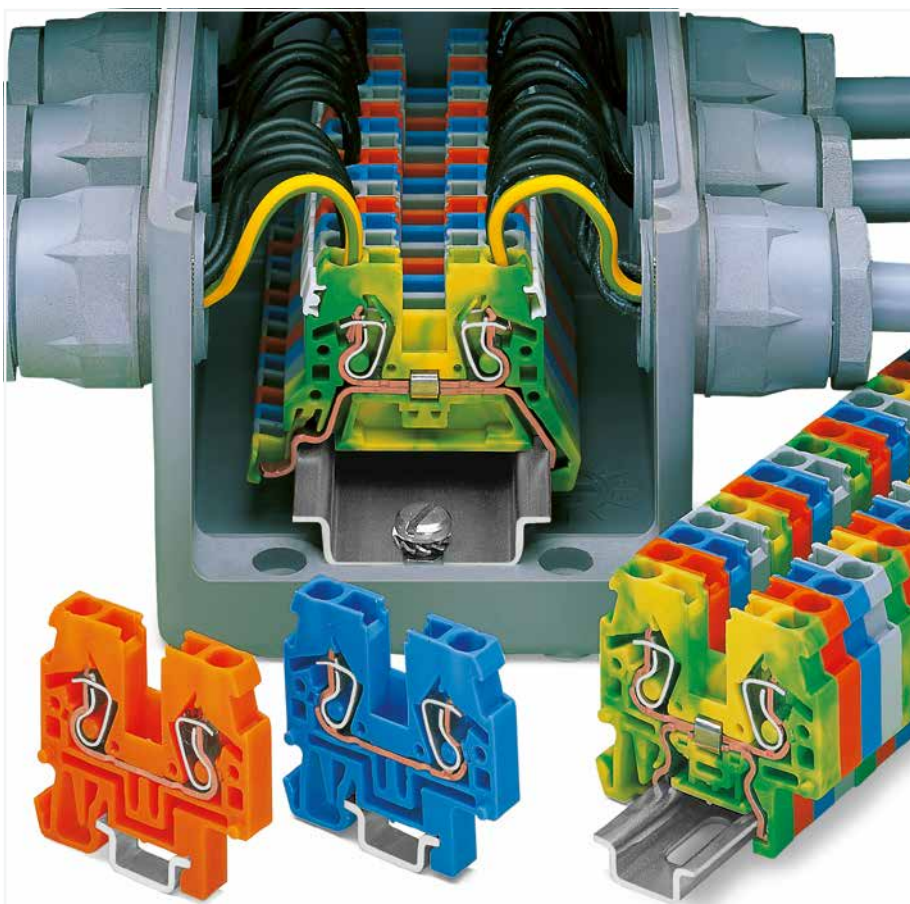

Commoning terminal blocks of different sizes via step-down jumpers.

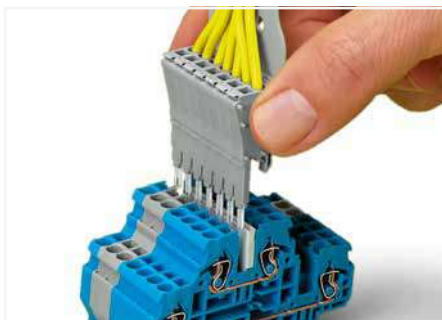

Testing: Using a pre-wired module assembly, similar to test plugs.

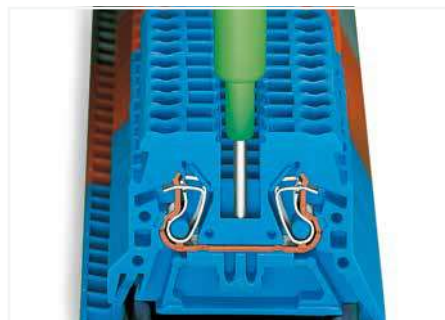

Testing with phase testing device, also possible with single-pole voltage tester.



CAGE CLAMP® terminates the following copper conductors: solid "s"



stranded "st"



fine-stranded "f-st", also with tinned single strands



CAGE CLAMP® termination:
Inserting a conductor via operating tool (0.08 ... 4 mm² "f-st").
With ferruled conductors, it is necessary to use a terminal block one size smaller than the conductor's nominal cross section.

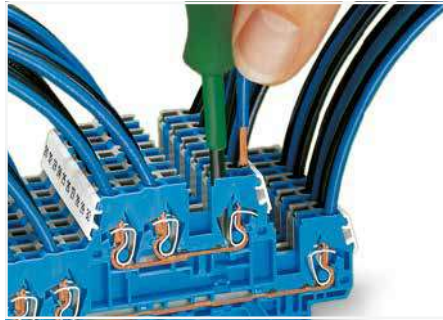

CAGE CLAMP® termination:
Inserting a conductor via operating tool (0.08 ... 4 mm² "f-st").

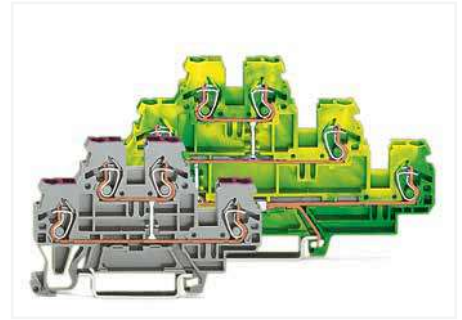

Multilevel terminal blocks:
Double- and triple-deck terminal blocks with internal comings acting as 4- and 6-conductor terminal blocks

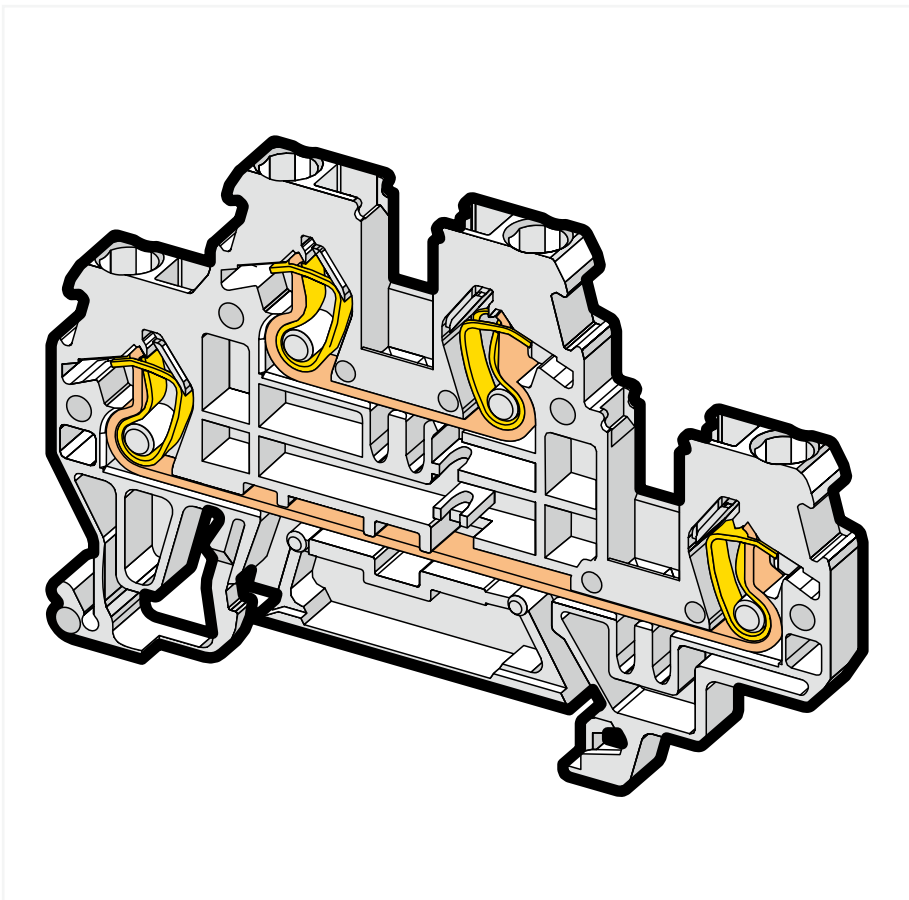

Protective warning marker (280-405); with a black high-voltage symbol

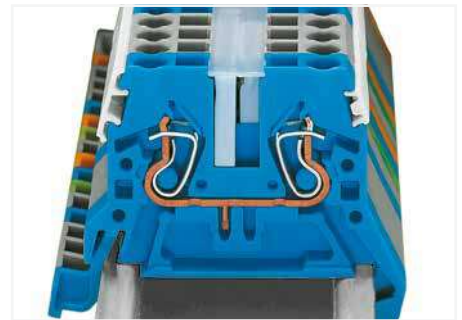

WMB markers in Mini-WSB marker slots
Marking strip; translucent
Mini-WSB markers

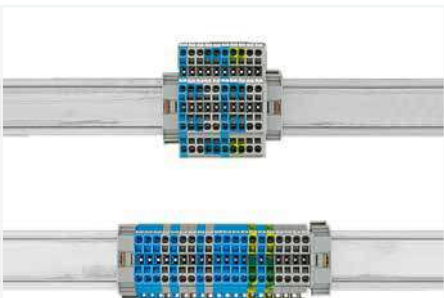

Use 50% less rail space with double-deck terminal blocks.

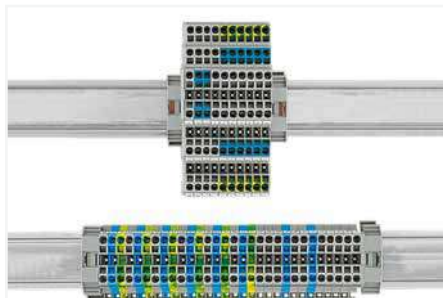

Use 67% less rail space with triple-deck terminal blocks.



Translucent marking strip (709-196) – jumpers below may be visible.



fine-stranded, tip-bonded



fine-stranded, with ferrule (gastight crimped)



fine-stranded, with pin terminal (gastight crimped)

Through/Ground Conductor/Ex and Double-Potential Terminal Block for DIN-35 and DIN-15 Rails

2.5 (4 "f-st") mm²; 870 Series

Technical Data	
0.08 ... 2.5 (4 "f-st") mm ² ①	28 ... 12 AWG
500 V / 6 kV / 3 ②	300 V, 20 A
I _N 24 A	
Terminal block width: 5 mm / 0.197 inch	
6 ... 7 mm / 0.24 ... 0.28 inch	

Technical Data	
0.08 ... 2.5 (4 "f-st") mm ² ①	28 ... 12 AWG
500 V / 6 kV / 3 ②	300 V, 20 A
I _N 24 A	
Terminal block width: 5 mm / 0.197 inch	
6 ... 7 mm / 0.24 ... 0.28 inch	

Technical Data	
0.08 ... 2.5 (4 "f-st") mm ² ①	28 ... 12 AWG
500 V / 6 kV / 3 ②	300 V, 20 A
I _N 24 A	
Terminal block width: 5 mm / 0.197 inch	
6 ... 7 mm / 0.24 ... 0.28 inch	

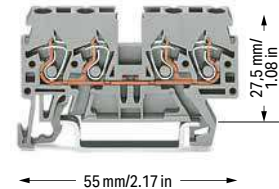
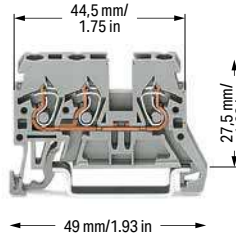
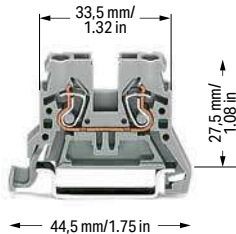

2-conductor through terminal block; for DIN-35 rail		
Color	Item No.	Pack. Unit
gray	870-901	100
blue	870-904 ③	100
orange	870-902	100
light gray ④	870-909 ④	100

3-conductor through terminal block; for DIN-35 rail		
Color	Item No.	Pack. Unit
gray	870-681	100
blue	870-684 ③	100
orange	870-682	100

4-conductor through terminal block; for DIN-35 rail		
Color	Item No.	Pack. Unit
gray	870-831	100
blue	870-834 ③	100
orange	870-832	100

2-conductor ground terminal block; for DIN-35 rail		
Notice: This ground conductor terminal block cannot be commoned with push-in type jumper bars!		
green-yellow	870-907	100
green-yellow ④	870-907/999-950 ④	100

3-conductor ground terminal block; for DIN-35 rail		
Notice: This ground conductor terminal block cannot be commoned with push-in type jumper bars!		
green-yellow	870-687	100

4-conductor ground terminal block; for DIN-35 rail		
Notice: This ground conductor terminal block cannot be commoned with push-in type jumper bars!		
green-yellow	870-837	100

Other terminal blocks with the same profile:		
Double-potential	870-826	Page 467

Accessories; item-specific			
End and intermediate plate; 2 mm thick			
	orange	870-924	100 (25)
	gray	870-923	100 (25)
	light gray	870-925	100 (25)

Accessories; item-specific			
End and intermediate plate; 1 mm thick			
	orange	870-934	100 (25)
	gray	870-933	100 (25)

Accessories; item-specific			
End and intermediate plate; 1 mm thick			
	orange	870-944	100 (25)
	gray	870-943	100 (25)

Separator; oversized; 2 mm thick			
	orange	870-929	100 (25)
	gray	870-928	100 (25)

Separator; oversized; 1 mm thick			
	orange	870-947	100 (25)
	gray	870-946	100 (25)

Separator; oversized; 1 mm thick			
	orange	870-949	100 (25)
	gray	870-948	100 (25)

End and intermediate plate; 2 mm thick; for 2-conductor ground conductor Ex terminal blocks only			
	green-yellow	870-926	100 (25)

Ex e/Ex i separator; orange; 3 mm thick			
	90 mm	209-190	50 (25)
	120 mm	209-191	50 (25)

Accessories; 870 Series

Appropriate marking systems: Mini-WSB/Mini-WSB Inline/WMB/WMB Inline

Insulation stop; 0.08 ... 0.2 mm ² "s" (0.14 mm ² "f-st"); 5 pcs/strip			
	white	280-470	200 (25)

Push-in type jumper bar; insulated; I _N 18 A; light gray			
	2-way	870-402	200 (25)
	3-way	870-403	200 (25)
	4-way	870-404	100 (25)
	5-way	870-405	100 (25)
	6-way	870-406	100 (25)
	7-way	870-407	100 (25)
	8-way	870-408	100 (25)
	9-way	870-409	100 (25)
	10-way	870-410	50 (25)

Push-in type jumper bar; insulated; I _N 18 A; light gray			
	1 to 3	870-433	200 (25)
	1 to 4	870-434	200 (25)
	1 to 5	870-435	100 (25)
	1 to 6	870-436	100 (25)
	1 to 7	870-437	100 (25)
	1 to 8	870-438	100 (25)
	1 to 9	870-439	100 (25)
	1 to 10	870-440	50 (25)

Insulation stop; 0.25 ... 0.5 mm ² ; 5 pcs/strip			
	light gray	280-471	200 (25)

Insulation stop; 0.75 ... 1 mm ² ; 5 pcs/strip			
	dark gray	280-472	200 (25)

Technical Data

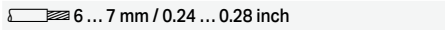
0.08 ... 2.5 (4 "f-st") mm² ① | 28 ... 12 AWG
 500 V / 6 kV / 3 ② | 300 V, 20 A, ③
 I_N 24 A
 Terminal block width: 5 mm / 0.197 inch
 6 ... 7 mm / 0.24 ... 0.28 inch

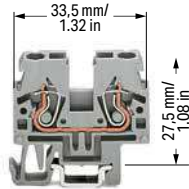

2-conductor through terminal block; for DIN-15 rail

Color	Item No.	Pack. Unit
gray	870-911	100
light gray	870-914 ③	100
orange	870-912	100
light gray ④	870-919 ④	100

2-conductor ground terminal block; for DIN-15 rail



Notice: This ground conductor terminal block cannot be commoned with push-in type jumper bars!
 green-yellow | 870-917 | 100

Accessories; item-specific

End and intermediate plate; 2 mm thick

	orange	870-924	100 (25)
	gray	870-923	100 (25)
	light gray	870-925	100 (25)

Separator; oversized; 2 mm thick

	orange	870-929	100 (25)
	gray	870-928	100 (25)

End and intermediate plate; 2 mm thick; for 2-conductor ground conductor Ex terminal blocks only

	green-yellow	870-926	100 (25)
---	--------------	---------	----------

Protective warning marker; with black high-voltage symbol; for 5 terminal blocks

	yellow	280-405	100 (25)
---	--------	---------	----------

Tap-off module; with anti-reverse mating protection; snaps together; 5 mm wide

	gray	870-425	100 (25)
---	------	---------	----------

Technical Data

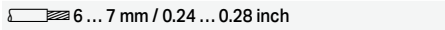
0.08 ... 2.5 (4 "f-st") mm² ① | 28 ... 12 AWG
 500 V / 6 kV / 3 ② | 300 V, 20 A, ③
 I_N 24 A
 Terminal block width: 5 mm / 0.197 inch
 6 ... 7 mm / 0.24 ... 0.28 inch

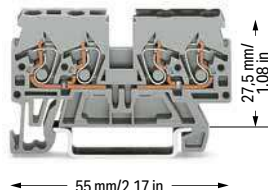

Double-potential terminal block; with integrated marking level

Color	Item No.	Pack. Unit
gray	870-826	100

Notice: These double-potential terminal blocks cannot be commoned with push-in type jumper bars!
 Front-entry double-potential terminal blocks are space savers.

Two independent feedthrough circuits are placed in one insulated housing on one level in just 5 mm. This achieves a width of just 2.5 mm versus standard through terminal blocks for a total height of just 27.5 mm from the upper-edge of DIN-rail.

Input and output of a circuit are placed on the same side of the terminal block. Both circuits can be individually marked according to input and output.



Technical data and accessories, visit www.wago.com

Accessories; item-specific

End and intermediate plate; 1 mm thick

	orange	870-944	100 (25)
	gray	870-943	100 (25)

Separator; oversized; 1 mm thick

	orange	870-949	100 (25)
	gray	870-948	100 (25)

Mini-WSB Inline, plain; 1,700 WMB markers (5 mm)/reel; 5 ... 5.2 mm stretchable

	white	2009-145	1
---	-------	----------	---

Mini-WSB marking card; white; 10 strips with 10 markers/ card; 5 mm wide markers

	plain	248-501	5
---	-------	---------	---

① Max. insulation diameter: 4.4 mm

② 500 V = rated voltage
 6 kV = rated impulse voltage
 3 = pollution degree (see Section 15)

③ Terminal blocks with a blue insulated housing are suitable for Ex i applications.

④ Suitable for Ex e II applications
 0.2 ... 2.5 (4 "f-st") mm² / 24 ... 12 AWG
 440 V; 22 A (see Section 15)
 Using one or more push-in type jumper bars, the maximum rated voltage is reduced to 275 V and the rated current to 13.5 A.

See application notes for:
 Insulation stop, page 425
 Tap-off module, page 518
 Group marker carrier, page 513

Approvals and corresponding ratings, visit www.wago.com



Mounting on DIN-15 rail:
 Snap individual terminal blocks onto the DIN-15 rail and slide together.

Removal from DIN-15 rail:
 Open assembly by laterally sliding terminal blocks with an operating tool and remove them from the rail.



In order to meet creepage and clearance requirements for Ex e applications, it is necessary to insert an end or intermediate plate between a through and a ground conductor terminal block.

End plates 870-923 (gray), 870-924 (orange) and 870-925 (light gray), as well as separator plates 870-928 (gray) and 870-929 (orange) cannot be assembled to 2-conductor ground Ex terminal blocks (870-907/999-950).

Double-Deck Terminal Block

2.5 (4 "f-st") mm²; 870 Series

Technical Data

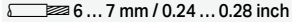
0.08 ... 2.5 (4 "f-st") mm² ① | 28 ... 12 AWG
 500 V / 6 kV / 3 ② | 300 V, 20 A I_N
 I_N 24 A
 Terminal block width: 5 mm / 0.197 inch
 6 ... 7 mm / 0.24 ... 0.28 inch

Technical Data

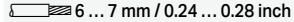
0.08 ... 2.5 (4 "f-st") mm² ① | 28 ... 12 AWG
 500 V / 6 kV / 3 ②
 I_N 24 A
 Terminal block width: 5 mm / 0.197 inch
 6 ... 7 mm / 0.24 ... 0.28 inch

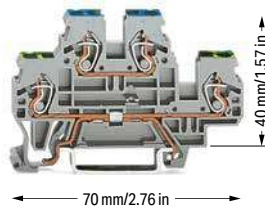
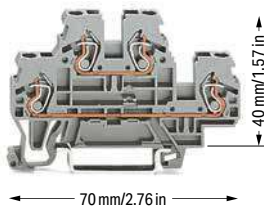

Double-deck terminal block; through/through terminal block; gray

	Item No.	Pack. Unit
○ L/L	870-501	50
○ N/L	870-502	50
○ L/N	870-503	50

Double-deck terminal block; ground conductor/through terminal block; gray

	Item No.	Pack. Unit
○ PE/N	870-517	50
○ PE/L	870-527	50

Double-deck terminal block; through/through terminal block; blue

● N/N	870-504 ③	50
-------	-----------	----

Double-deck terminal block; ground conductor/through terminal block; light gray

○ PE/L ④	870-967/999-950 ③	50
----------	-------------------	----

Double-deck terminal block; through/through terminal block; light gray

○ L/L ⑤	870-961 ④	50
---------	-----------	----

Other terminal blocks with the same profile:

Diode	870-540/281-410	Page 472
LED	870-543/281-434	Page 472

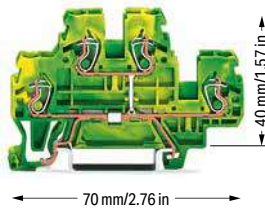
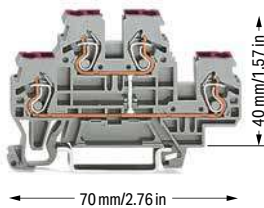

Double-deck terminal block; 4-conductor through terminal block; internally commoned; Violet conductor entry; gray

	Item No.	Pack. Unit
○ L	870-508	50

Double-deck terminal block; 4-conductor ground terminal block; internally commoned; green-yellow

	Item No.	Pack. Unit
● PE	870-507	50

Double-deck terminal block; 4-conductor through terminal block; internally commoned; Violet conductor entry; blue

● N	870-509 ③	50
-----	-----------	----

- Max. insulation diameter: 4.4 mm
 - 500 V = rated voltage
6 kV = rated impulse voltage
3 = pollution degree (see Section 15)
 - Terminal blocks with a blue insulated housing are suitable for Ex i applications.
 - Suitable for Ex e II applications
0.2 ... 2.5 (4 "f-st") mm² / 24 ... 12 AWG
440 V; 22 A (see Section 15)
Using one or more push-in type jumper bars, the maximum rated voltage is reduced to 275 V and the rated current to 13.5 A.
- See application notes for:
Insulation stop, page 425
Group marker carrier, page 513
- Approvals and corresponding ratings, visit www.wago.com

Accessories; 870 Series

- Appropriate marking systems:
Mini-WSB/Mini-WSB Inline/WMB/WMB Inline
- End and intermediate plate; 2 mm thick
- | | | |
|--------|---------|----------|
| orange | 870-519 | 100 (25) |
| gray | 870-518 | 100 (25) |

- Ex e/Ex i separator; orange; 3 mm thick
- | | | |
|----------|---------|---------|
| 125.5 mm | 209-192 | 50 (25) |
|----------|---------|---------|

- Insulation stop; 0.08 ... 0.2 mm² "s" (0.14 mm² "f-st"); 5 pcs/strip
- | | | |
|-------|---------|----------|
| white | 280-470 | 200 (25) |
|-------|---------|----------|

- Insulation stop; 0.25 ... 0.5 mm²; 5 pcs/strip
- | | | |
|------------|---------|----------|
| light gray | 280-471 | 200 (25) |
|------------|---------|----------|

- Insulation stop; 0.75 ... 1 mm²; 5 pcs/strip
- | | | |
|-----------|---------|----------|
| dark gray | 280-472 | 200 (25) |
|-----------|---------|----------|

- Protective warning marker; with black high-voltage symbol; for 5 terminal blocks
- | | | |
|--------|---------|----------|
| yellow | 280-405 | 100 (25) |
|--------|---------|----------|

- Push-in type jumper bar; insulated; I_N 18 A; light gray
- | | | |
|--------|---------|----------|
| 2-way | 870-402 | 200 (25) |
| 3-way | 870-403 | 200 (25) |
| 4-way | 870-404 | 100 (25) |
| 5-way | 870-405 | 100 (25) |
| 6-way | 870-406 | 100 (25) |
| 7-way | 870-407 | 100 (25) |
| 8-way | 870-408 | 100 (25) |
| 9-way | 870-409 | 100 (25) |
| 10-way | 870-410 | 50 (25) |

- Push-in type jumper bar; insulated; I_N 18 A; light gray
- | | | |
|---------|---------|----------|
| 1 to 3 | 870-433 | 200 (25) |
| 1 to 4 | 870-434 | 200 (25) |
| 1 to 5 | 870-435 | 100 (25) |
| 1 to 6 | 870-436 | 100 (25) |
| 1 to 7 | 870-437 | 100 (25) |
| 1 to 8 | 870-438 | 100 (25) |
| 1 to 9 | 870-439 | 100 (25) |
| 1 to 10 | 870-440 | 50 (25) |

3-Conductor Double-Deck Terminal Block 2.5 (4 "f-st") mm²; 870 Series

Technical Data

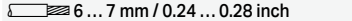
0.08 ... 2.5 (4 "f-st") mm² ① | 28 ... 12 AWG
 500 V / 6 kV / 3 ② | 300 V, 20 A, I_N
 I_N 24 A
 Terminal block width: 5 mm / 0.197 inch
 6 ... 7 mm / 0.24 ... 0.28 inch

Technical Data

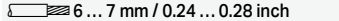
0.08 ... 2.5 (4 "f-st") mm² ① | 28 ... 12 AWG
 500 V / 6 kV / 3 ②
 I_N 24 A
 Terminal block width: 5 mm / 0.197 inch
 6 ... 7 mm / 0.24 ... 0.28 inch

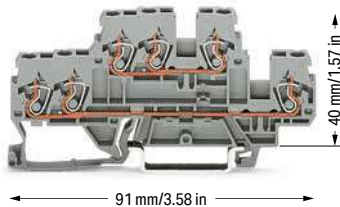

3-conductor double-deck terminal block; through/through terminal block; gray

	Item No.	Pack. Unit
○ L/L	870-531	50
○ N/L	870-532	50
○ L/N	870-533	50

3-conductor double-deck terminal block; through/through terminal block; blue

● N/N	870-534 ③	50
-------	-----------	----

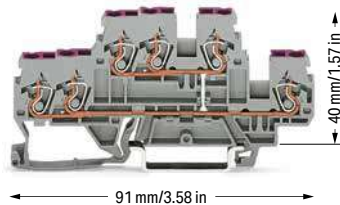

3-conductor double-deck terminal block; 6-conductor through terminal block; internally commoned; Violet conductor entry; gray

	Item No.	Pack. Unit
○ L	870-538	50

3-conductor double-deck terminal block; 6-conductor through terminal block; internally commoned; Violet conductor entry; blue

● N	870-539 ③	50
-----	-----------	----

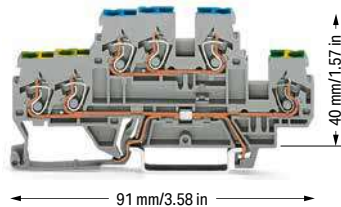

3-conductor double-deck terminal block; ground conductor/through terminal block; gray

	Item No.	Pack. Unit
○ PE/N	870-535	50
○ PE/L	870-536	50

3-conductor double-deck terminal block; 6-conductor ground terminal block; internally commoned; green-yellow

	Item No.	Pack. Unit
● PE	870-537	50

- ① Max. insulation diameter: 4.4 mm
- ② 500 V = rated voltage
6 kV = rated impulse voltage
3 = pollution degree (see Section 15)
- ③ Terminal blocks with a blue insulated housing are suitable for Ex i applications.

See application notes for:
 Insulation stop, page 425
 Group marker carrier, page 513

Approvals and corresponding ratings, visit www.wago.com

Accessories; 870 Series

Appropriate marking systems:
 Mini-WSB/Mini-WSB Inline/WMB/WMB Inline

End and intermediate plate; 2 mm thick

	orange	870-574	100 (25)
	gray	870-573	100 (25)

Insulation stop; 0.08 ... 0.2 mm² "s" (0.14 mm² "f-st"); 5 pcs/strip

	white	280-470	200 (25)
---	-------	---------	----------

Insulation stop; 0.25 ... 0.5 mm²; 5 pcs/strip

	light gray	280-471	200 (25)
--	------------	---------	----------

Insulation stop; 0.75 ... 1 mm²; 5 pcs/strip

	dark gray	280-472	200 (25)
---	-----------	---------	----------

Protective warning marker; with black high-voltage symbol; for 5 terminal blocks

	yellow	280-405	100 (25)
---	--------	---------	----------

Push-in type jumper bar; insulated; I_N 18 A; light gray

	2-way	870-402	200 (25)
	3-way	870-403	200 (25)
	4-way	870-404	100 (25)
	5-way	870-405	100 (25)
	6-way	870-406	100 (25)
	7-way	870-407	100 (25)
	8-way	870-408	100 (25)
	9-way	870-409	100 (25)
	10-way	870-410	50 (25)

Push-in type jumper bar; insulated; I_N 18 A; light gray

	1 to 3	870-433	200 (25)
	1 to 4	870-434	200 (25)
	1 to 5	870-435	100 (25)
	1 to 6	870-436	100 (25)
	1 to 7	870-437	100 (25)
	1 to 8	870-438	100 (25)
	1 to 9	870-439	100 (25)
	1 to 10	870-440	50 (25)

Mini-WSB Inline, plain; 1,700 WMB markers (5 mm)/reel; 5 ... 5.2 mm stretchable

	white	2009-145	1
---	-------	----------	---

Mini-WSB marking card; white; 10 strips with 10 markers/card; 5 mm wide markers

	plain	248-501	5
---	-------	---------	---

Triple-Deck Terminal Block

2.5 (4 "f-st") mm²; 870 Series

Technical Data

0.08 ... 2.5 (4 "f-st") mm² ① | 28 ... 12 AWG
 500 V / 6 kV / 3 ② | 300 V, 20 A I_N
 I_N 24 A
 Terminal block width: 5 mm / 0.197 inch
 6 ... 7 mm / 0.24 ... 0.28 inch

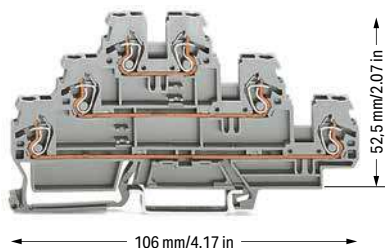

Triple-deck terminal block; through/through/through terminal block; gray

	Item No.	Pack. Unit
○ L/L/L	870-551	50
○ L/L/N	870-553	50

Triple-deck terminal block; through/through/through terminal block; light gray

○ L/L/L ⊕	870-951 ⊕	50
-----------	-----------	----

Other terminal blocks with the same profile:

Diode	870-590/281-410	Page 474
LED	870-593/281-434	Page 474

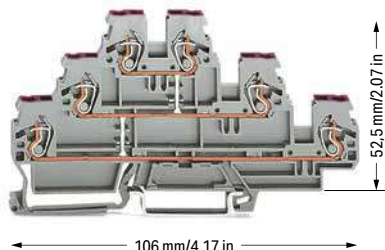

Triple-deck terminal block; 6-conductor through terminal block; internally commoned; Violet conductor entry; gray

	Item No.	Pack. Unit
○ L	870-556	50

Technical Data

0.08 ... 2.5 (4 "f-st") mm² ① | 28 ... 12 AWG
 500 V / 6 kV / 3 ②
 I_N 24 A
 Terminal block width: 5 mm / 0.197 inch
 6 ... 7 mm / 0.24 ... 0.28 inch

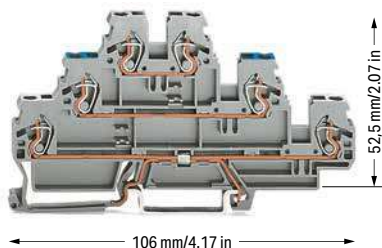

Triple-deck terminal block; shield conductor/through/through terminal block; gray

	Item No.	Pack. Unit
○ Shield/N/L	870-558	50
○ Shield/L/L	870-559	50

Triple-deck terminal block; ground conductor/through/through terminal block; gray

○ PE/N/L	870-567	50
○ PE/L/L	870-577	50

Triple-deck terminal block; ground conductor/through/through terminal block; light gray

○ PE/L/L ⊕	870-957/999-950 ⊕	50
------------	-------------------	----

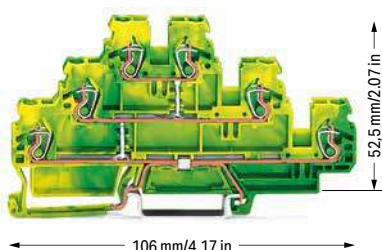

Triple-deck terminal block; 6-conductor ground terminal block; internally commoned; green-yellow

	Item No.	Pack. Unit
● PE	870-557	50

- Max. insulation diameter: 4.4 mm
 - 500 V = rated voltage
6 kV = rated impulse voltage
3 = pollution degree (see Section 15)
 - Terminal blocks with a blue insulated housing are suitable for Ex i applications.
 - Suitable for Ex e II applications
0.2 ... 2.5 (4 "f-st") mm² / 24 ... 12 AWG
440 V; 22 A (see Section 15)
Using one or more push-in type jumper bars, the maximum rated voltage is reduced to 275 V and the rated current to 13.5 A.
- See application notes for:
Insulation stop, page 425
Group marker carrier, page 513
- Approvals and corresponding ratings, visit www.wago.com

Accessories; 870 Series

Appropriate marking systems:
Mini-WSB/Mini-WSB Inline/WMB/WMB Inline

End and intermediate plate; 2 mm thick

orange	870-569	100 (25)
gray	870-568	100 (25)

Insulation stop; 0.08 ... 0.2 mm² "s" (0.14 mm² "f-st"); 5 pcs/strip

white	280-470	200 (25)
-------	---------	----------

Insulation stop; 0.25 ... 0.5 mm²; 5 pcs/strip

light gray	280-471	200 (25)
------------	---------	----------

Insulation stop; 0.75 ... 1 mm²; 5 pcs/strip

dark gray	280-472	200 (25)
-----------	---------	----------

Protective warning marker; with black high-voltage symbol; for 5 terminal blocks

yellow	280-405	100 (25)
--------	---------	----------

Push-in type jumper bar; insulated; I_N 18 A; light gray

2-way	870-402	200 (25)
3-way	870-403	200 (25)
4-way	870-404	200 (25)
5-way	870-405	100 (25)
6-way	870-406	100 (25)
7-way	870-407	100 (25)
8-way	870-408	100 (25)
9-way	870-409	100 (25)
10-way	870-410	50 (25)

Push-in type jumper bar; insulated; I_N 18 A; light gray

1 to 3	870-433	200 (25)
1 to 4	870-434	200 (25)
1 to 5	870-435	100 (25)
1 to 6	870-436	100 (25)
1 to 7	870-437	100 (25)
1 to 8	870-438	100 (25)
1 to 9	870-439	100 (25)
1 to 10	870-440	50 (25)

Mini-WSB Inline, plain; 1,700 WMB markers (5 mm)/reel; 5 ... 5.2 mm stretchable

white	2009-145	1
-------	----------	---

Group Marker Carrier, Marking Strip and Push-In Type Jumper Bar

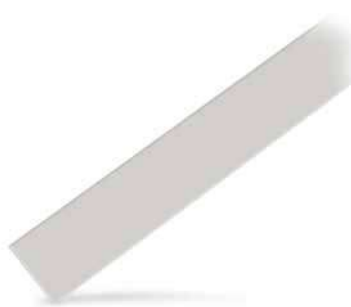

Group marker carrier; fits into the jumper slot of the current bars
Module width: 5 mm

Color	Item No.	Pack. Unit
<input type="radio"/> gray	870-184	50 (25)

Group marker carrier; fits into the jumper slot of the current bars
Module width: 10 mm

<input type="radio"/> gray	870-183	50 (25)
----------------------------	---------	---------

Group marker carrier; fits into the jumper slot of the current bars
Module width: 15 mm

<input type="radio"/> gray	870-182	50 (25)
----------------------------	---------	---------

Marking strip; plain; 7.5 mm wide; 1 m long

Color	Item No.	Pack. Unit
<input type="radio"/> translucent	709-196	50 (25)

In addition to the plastic marker strips, group marker carriers are now available for the WMB and WSB marking systems. They can be mounted in parallel to a push-in type jumper bar via the open jumper contact slot. It is also very useful if the marker slots on the side of the terminal block are hidden. The carriers are available in the following widths: 5 mm (0.197 inch), 10 mm (0.394 inch) and 15 mm (0.591 inch).

Notice:

Group marker carriers are not suitable for ground conductor terminal blocks and double potential terminal blocks as they have no jumper contact slots.



Ready-made push-in type jumper bar; insulated; I_N 18 A; light gray

	Item No.	Pack. Unit
<input type="radio"/> 1-3-5	870-405/011-000	200 (25)
<input type="radio"/> 1-3-5-7	870-407/011-000	200 (25)
<input type="radio"/> 1-3-5-7-9	870-409/011-000	100 (25)

Delta jumper; insulated; 1-2 3-4 5-6; I_N 18 A

Color	Item No.	Pack. Unit
<input type="radio"/> light gray	870-406/020-000	100 (25)

Double-Deck Diode Terminal Block and LED Terminal Block 2.5 (4 "f-st") mm²; 870 Series

Technical Data

0.08 ... 2.5 (4 "f-st") mm² ① | 28 ... 12 AWG

U_N 250 V; U_{RM} 1000 V

1N4007 – 0.5 A continuous current

Terminal block width: 5 mm / 0.197 inch

6 ... 7 mm / 0.24 ... 0.28 inch

Technical Data

0.08 ... 2.5 (4 "f-st") mm² ① | 28 ... 12 AWG

U_N 250 V; U_{RM} 1000 V

1N4007 – 0.5 A continuous current

Terminal block width: 5 mm / 0.197 inch

6 ... 7 mm / 0.24 ... 0.28 inch

Technical Data

0.08 ... 2.5 (4 "f-st") mm² ① | 28 ... 12 AWG

24 VDC

I_f 0.025 A max.

Terminal block width: 5 mm / 0.197 inch

6 ... 7 mm / 0.24 ... 0.28 inch

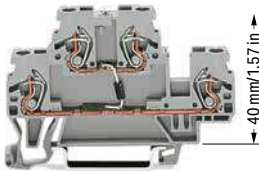

70 mm/2.76 in

870-540/281-410

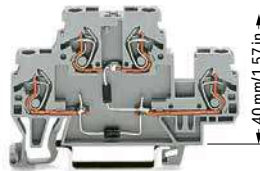

70 mm/2.76 in

870-541/281-491

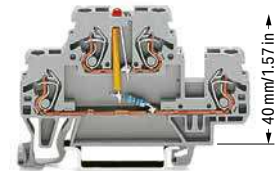

70 mm/2.76 in

870-543/281-413

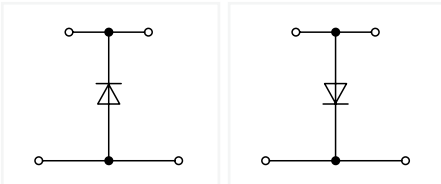

Double-deck diode terminal block; with 1N4007 diode

	Item No.	Pack. Unit
○ anode bottom	870-540/281-410	50
○ anode top	870-540/281-411	50

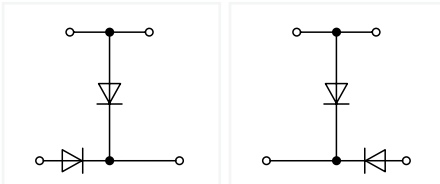

Double-deck diode terminal block; with two 1N4007 diodes

	Item No.	Pack. Unit
○ anode top, anode left	870-541/281-492	50
○ anode top, anode right	870-541/281-491	50

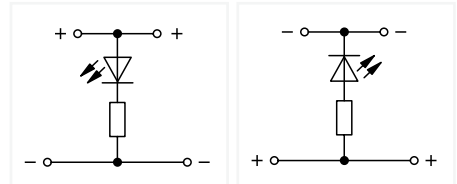

Double-deck LED terminal block; with red LED

	Item No.	Pack. Unit
○ anode top	870-543/281-413	50
○ anode bottom	870-543/281-434	50

Other terminal blocks with the same profile:

Through	870-501	Page 468
---------	---------	----------

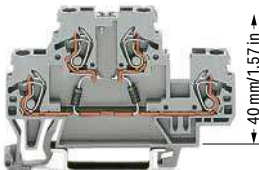

70 mm/2.76 in

870-542/281-487

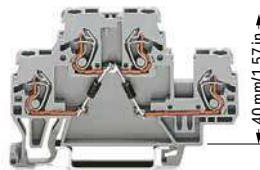

70 mm/2.76 in

870-541/281-490

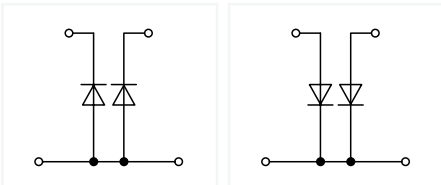

Double-deck diode terminal block; with two 1N4007 diodes

	Item No.	Pack. Unit
○ anodes bottom	870-542/281-487	50
○ anodes top	870-542/281-488	50

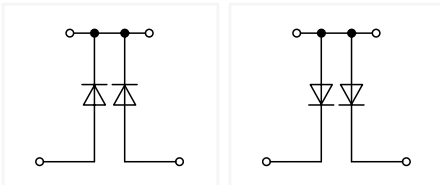

Double-deck diode terminal block; with two 1N4007 diodes

	Item No.	Pack. Unit
○ anodes bottom	870-541/281-489	50
○ anodes top	870-541/281-490	50

Double-Deck Diode Terminal Blocks and LED Terminal Blocks Circuit Configuration Examples

1 Max. insulation diameter: 4.4 mm

See application notes for:
Insulation stop, page 425
Group marker carrier, page 513

Approvals and corresponding ratings,
visit www.wago.com

Accessories; 870 Series

Appropriate marking systems:
Mini-WSB/Mini-WSB Inline/WMB/WMB Inline

End and intermediate plate; 2 mm thick

	orange	870-519	100 (25)
	gray	870-518	100 (25)

Insulation stop; 0.08 ... 0.2 mm² "s" (0.14 mm² "f-st"); 5 pcs/strip

	white	280-470	200 (25)
---	-------	---------	----------

Insulation stop; 0.25 ... 0.5 mm²; 5 pcs/strip

	light gray	280-471	200 (25)
---	------------	---------	----------

Insulation stop; 0.75 ... 1 mm²; 5 pcs/strip

	dark gray	280-472	200 (25)
---	-----------	---------	----------

Protective warning marker; with black high-voltage symbol; for 5 terminal blocks

	yellow	280-405	100 (25)
---	--------	---------	----------

Push-in type jumper bar; insulated; I_N 18 A; light gray

	2-way	870-402	200 (25)
	3-way	870-403	200 (25)
	4-way	870-404	100 (25)
	5-way	870-405	100 (25)
	6-way	870-406	100 (25)
	7-way	870-407	100 (25)
	8-way	870-408	100 (25)
	9-way	870-409	100 (25)
	10-way	870-410	50 (25)

Push-in type jumper bar; insulated; I_N 18 A; light gray

	1 to 3	870-433	200 (25)
	1 to 4	870-434	200 (25)
	1 to 5	870-435	100 (25)
	1 to 6	870-436	100 (25)
	1 to 7	870-437	100 (25)
	1 to 8	870-438	100 (25)
	1 to 9	870-439	100 (25)
	1 to 10	870-440	50 (25)

Marking strip; plain; 7.5 mm wide; 1 m long

	translucent	709-196	1
---	-------------	---------	---

Mini-WSB Inline, plain; 1,700 WMB markers (5 mm)/reel; 5 ... 5.2 mm stretchable

	white	2009-145	1
---	-------	----------	---

Mini-WSB marking card; white; 10 strips with 10 markers/ card; 5 mm wide markers

	plain	248-501	5
---	-------	---------	---

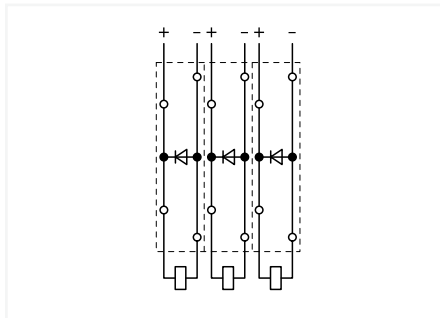

Recovery diodes can be created using the following terminal blocks:
870-540/281-410 or 870-540/281-411

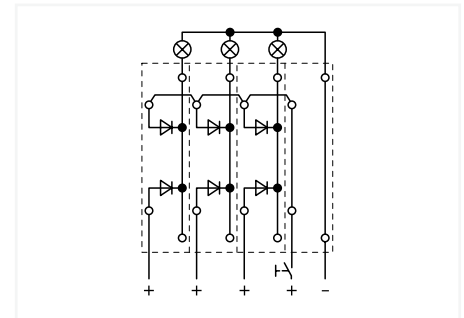

Lamp test circuits can be created using the following terminal blocks:
870-542/281-487 or 870-542/281-488

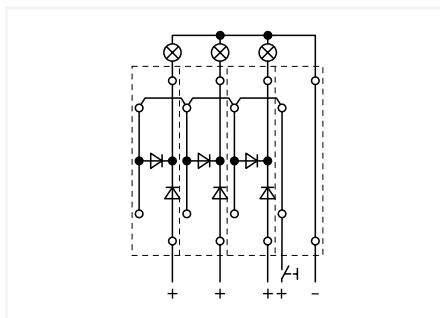

Lamp test circuits can be created using the following terminal blocks:
870-541/281-492 or 870-541/281-491

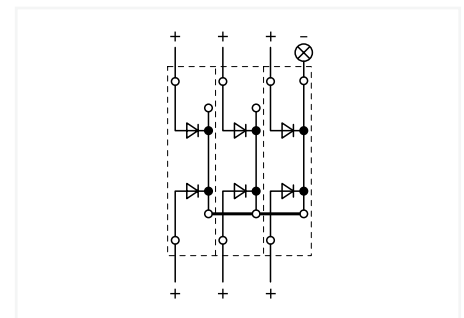

Collective fault signals can be created using the following terminal blocks:
870-541/281-489 or 870-541/281-490

Double-deck diode terminal blocks were specifically developed for custom diode circuits, such as lamp test and collective fault signal circuits. Using LED terminal blocks, monitoring units can be designed, e.g., for control and operating circuits. These terminal blocks provide high-density wiring in a width of just 5 mm.

Push-in type jumper bars provide additional options for custom circuit design.

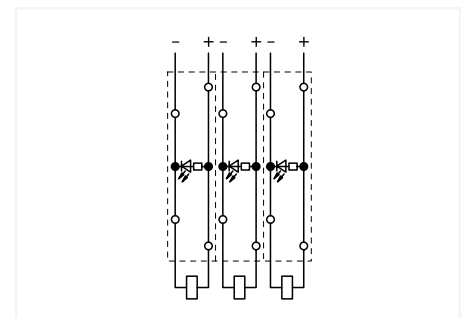

Circuit-related voltage indications can be created using the following terminal blocks:
870-543/281-434 or 870-543/281-413

Triple-Deck Diode Terminal Block and LED Terminal Block 2.5 (4 "f-st") mm²; 870 Series

Technical Data

0.08 ... 2.5 (4 "f-st") mm² ① | 28 ... 12 AWG

U_N 250 V; U_{RM} 1000 V

1N4007 – 0.5 A continuous current

Terminal block width: 5 mm / 0.197 inch

6 ... 7 mm / 0.24 ... 0.28 inch

Technical Data

0.08 ... 2.5 (4 "f-st") mm² ① | 28 ... 12 AWG

U_N 250 V; U_{RM} 1000 V

1N4007 – 0.5 A continuous current

Terminal block width: 5 mm / 0.197 inch

6 ... 7 mm / 0.24 ... 0.28 inch

Technical Data

0.08 ... 2.5 (4 "f-st") mm² ① | 28 ... 12 AWG

24 VDC

I_f 0.025 A max.

Terminal block width: 5 mm / 0.197 inch

6 ... 7 mm / 0.24 ... 0.28 inch

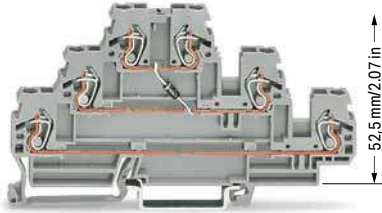

106 mm/4.17 in

280-590/281-410

280-590/281-411

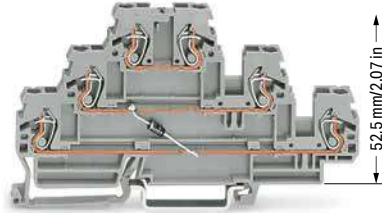

106 mm/4.17 in

280-590/281-675

280-590/281-676

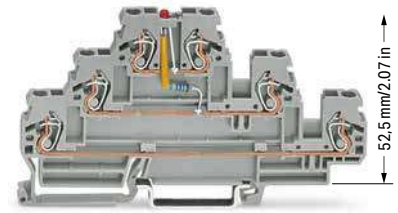

106 mm/4.17 in

280-593/281-434

280-593/281-413

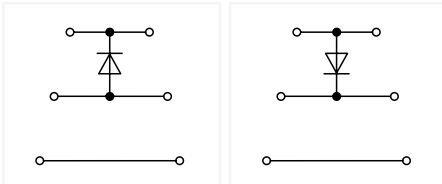

Triple-deck diode terminal block; with 1N4007 diode

	Item No.	Pack. Unit
○ anode bottom	870-590/281-410	50
○ anode top	870-590/281-411	50

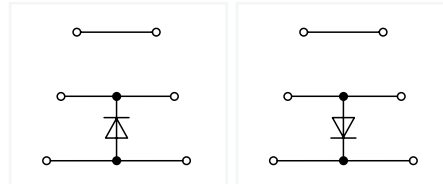

Triple-deck diode terminal block; with two 1N4007 diodes

	Item No.	Pack. Unit
○ anode bottom	870-590/281-675	50
○ anode top	870-590/281-676	50

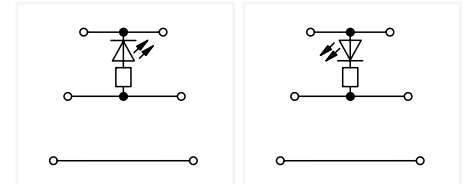

Triple-deck LED terminal block; with red LED

	Item No.	Pack. Unit
○ anode bottom	870-593/281-434	50
○ anode top	870-593/281-413	50

8

Other terminal blocks with the same profile:

Through	870-551	Page 470
---------	---------	----------



106 mm/4.17 in

280-596/281-673

280-596/281-674

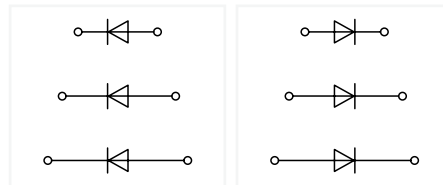

Triple-deck diode terminal block; with two 1N4007 diodes

	Item No.	Pack. Unit
○ anodes right	870-596/281-673	50
○ anodes left	870-596/281-674	50

1 Max. insulation diameter: 4.4 mm

See application notes for:
Insulation stop, page 425
Group marker carrier, page 513

Approvals and corresponding ratings,
visit www.wago.com

Accessories; 870 Series

Appropriate marking systems:
Mini-WSB/Mini-WSB Inline/WMB/WMB Inline

End and intermediate plate; 2 mm thick



orange	870-569	100 (25)
gray	870-568	100 (25)

Insulation stop; 0.08 ... 0.2 mm² "s" (0.14 mm² "f-st"); 5 pcs/strip



white	280-470	200 (25)
-------	---------	----------

Insulation stop; 0.25 ... 0.5 mm²; 5 pcs/strip



light gray	280-471	200 (25)
------------	---------	----------

Insulation stop; 0.75 ... 1 mm²; 5 pcs/strip



dark gray	280-472	200 (25)
-----------	---------	----------

Protective warning marker; with black high-voltage symbol; for 5 terminal blocks



yellow	280-405	100 (25)
--------	---------	----------

Push-in type jumper bar; insulated; I_N 18 A; light gray



2-way	870-402	200 (25)
3-way	870-403	200 (25)
4-way	870-404	100 (25)
5-way	870-405	100 (25)
6-way	870-406	100 (25)
7-way	870-407	100 (25)
8-way	870-408	100 (25)
9-way	870-409	100 (25)
10-way	870-410	50 (25)

Push-in type jumper bar; insulated; I_N 18 A; light gray



1 to 3	870-433	200 (25)
1 to 4	870-434	200 (25)
1 to 5	870-435	100 (25)
1 to 6	870-436	100 (25)
1 to 7	870-437	100 (25)
1 to 8	870-438	100 (25)
1 to 9	870-439	100 (25)
1 to 10	870-440	50 (25)

Marking strip; plain; 7.5 mm wide; 1 m long



translucent	709-196	1
-------------	---------	---

Mini-WSB Inline, plain; 1,700 WMB markers (5 mm)/reel; 5 ... 5.2 mm stretchable



white	2009-145	1
-------	----------	---

Mini-WSB marking card; white; 10 strips with 10 markers/card; 5 mm wide markers



plain	248-501	5
-------	---------	---

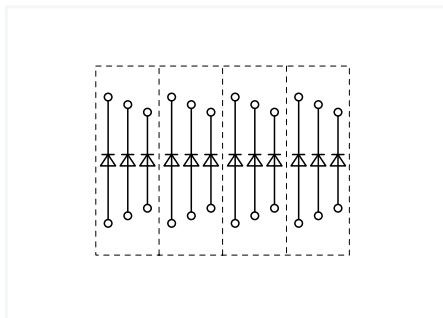

Triple-deck diode terminal blocks were specifically developed for custom diode circuits, such as lamp test and collective fault signal circuits.

Using LED terminal blocks, monitoring units can be designed, e.g., for control and operating circuits.

These terminal blocks provide high-density wiring in a width of just 5 mm.

Push-in type jumper bars provide additional options for custom circuit design.

Pluggable Tap-Off Modules 870 Series Description and Installation

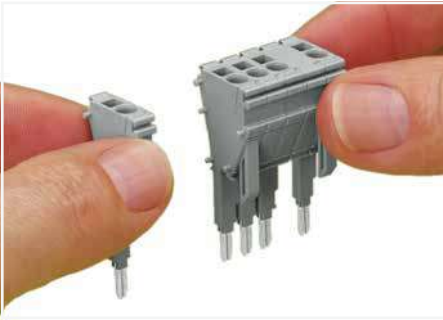

Snapping tap-off and spacer modules together to assemble a multipole tap-off module (max. 10 poles).



Module assembly with CAGE CLAMP® connections (0.25 ... 2.5 mm²/24 ... 14 AWG), including strain relief plate and marker slots for Mini-WSB or WMB markers.

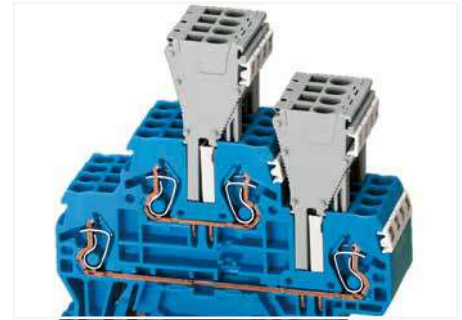

The tap-off module assembly can be directly plugged into the jumper contact slot of the current bar. The terminal blocks can also be commoned via push-in type jumper bars parallel to the jumper slots being used by the modules.



CAGE CLAMP® termination:
Tap-off modules are used when additional or removable connections are required (can be used as a permanent connection or a test plug).
Wiring is possible whether the modules are plugged into the assembly or not.

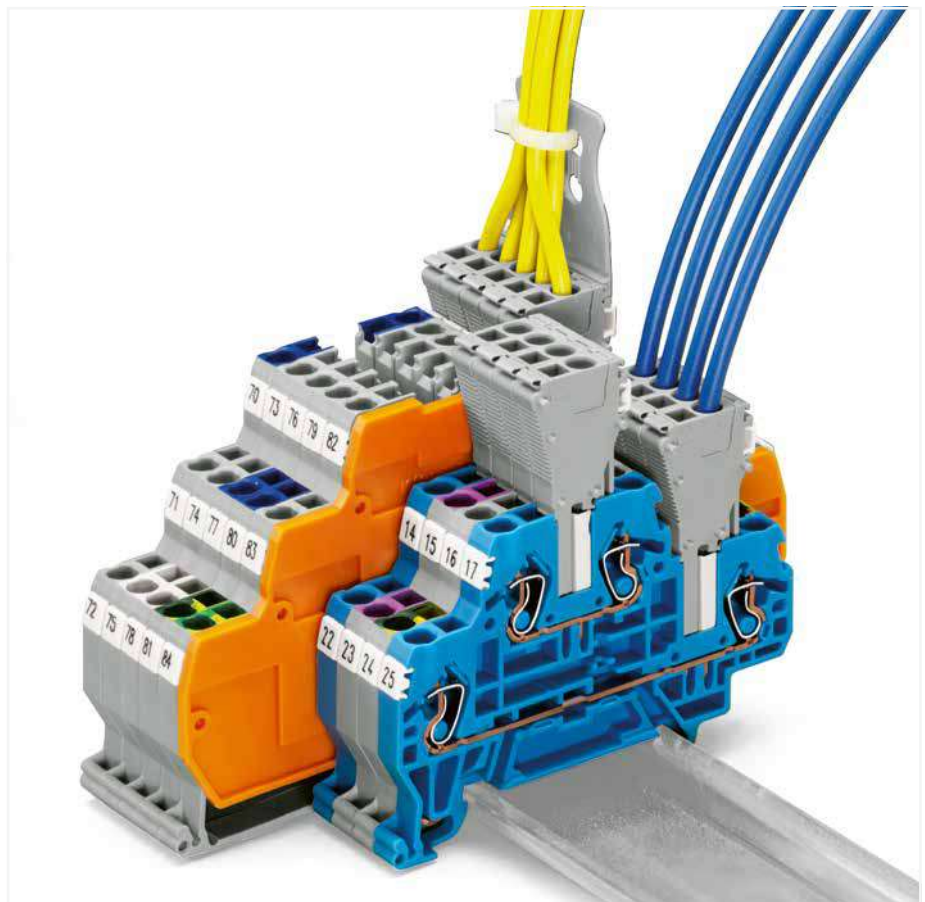

8

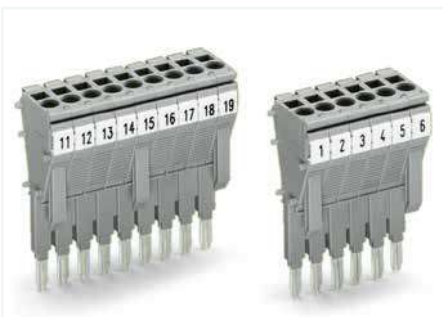

Using anti-reverse mating modules at both ends of a module assembly prevents reverse mating.



Three anti-reverse mating modules are necessary when snapping more than seven tap-off modules together.

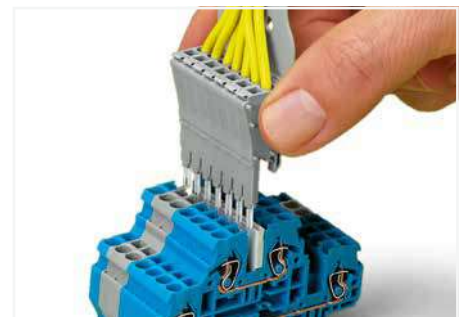

Testing is also possible using a pre-wired tap-off module assembly in the very same way as test plugs.



CAGE CLAMP® terminates the following copper conductors: solid "s"



stranded "st"



fine-stranded "f-st", also with tinned single strands

Pluggable Tap-Off Module 870 Series

Technical Data

0.25 ... 2.5 mm² | 22 ... 14 AWG

500 V / 6 kV / 3 ①

I_N 18 A

Module width: 5 mm / 0.197 inch

 10 mm / 0.38 inch

Technical Data

0.25 ... 2.5 mm² | 22 ... 14 AWG

500 V / 6 kV / 3 ①

I_N 10 A

Module width: 5 mm / 0.197 inch

 10 mm / 0.38 inch

- ① 500 V = rated voltage
6 kV = rated impulse voltage
3 = pollution degree
(see Section 15)

Approvals and corresponding ratings,
visit www.wago.com



Pluggable tap-off module; with anti-reverse mating protection; snaps together; for 870 Series Rail-Mount Terminal Blocks with jumper slots in the current bar

Color	Item No.	Pack. Unit
<input type="radio"/> gray	870-425	100 (25)

Pluggable tap-off module; snaps together; for 870 Series Rail-Mount Terminal Blocks with jumper slots in the current bar

Color	Item No.	Pack. Unit
<input type="radio"/> gray	870-426	100 (25)

Spacer module; snaps together; bridges terminal blocks

<input type="radio"/> gray	870-427	100 (25)
----------------------------	---------	----------

Accessories; for pluggable tap-off modules

Appropriate marking systems: Mini-WSB/Mini-WSB Inline/WMB/WMB Inline

Strain relief plate; gray



35 mm wide	734-326	100 (25)
6 mm wide	734-327	100 (25)
12.5 mm wide	734-328	100 (25)
25 mm wide	734-329	100 (25)

Mini-WSB marking card; white; 10 strips with 10 markers/card; 5 mm wide markers

plain	248-501	5
-------	---------	---

WMB marking card; white; 10 strips with 10 markers/card; stretchable 5 ... 5.2 mm

plain	793-5501	5
-------	----------	---

WMB marking card; white; 10 strips with 10 markers/card; for 5 ... 17.5 mm terminal block width

plain	793-501	5
-------	---------	---

Sensor Terminal Blocks and Actuator Terminal Blocks

270 Series

Description and Installation

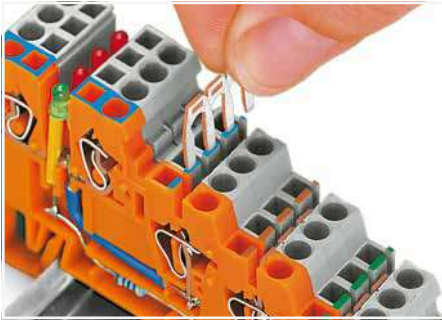

Inserting a jumper.

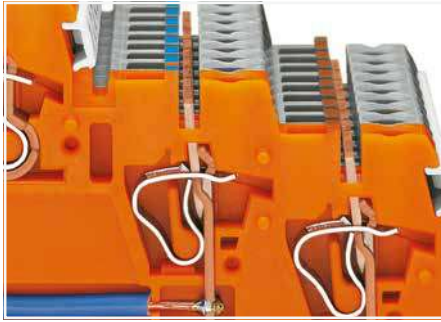

Commoning a supply voltage using uninsulated push-in type jumper bars, 2- to 9-way or 17-way (2 x 8 bits), depending on application.



Commoning signal level voltage via insulated push-in type jumper bars (870 Series) – 2- to 9-way, depending on application. Sensor LED terminal blocks cannot be commoned!



Terminal block assembly: Sensor terminal blocks



Terminal block assembly: Sensor LED terminal blocks

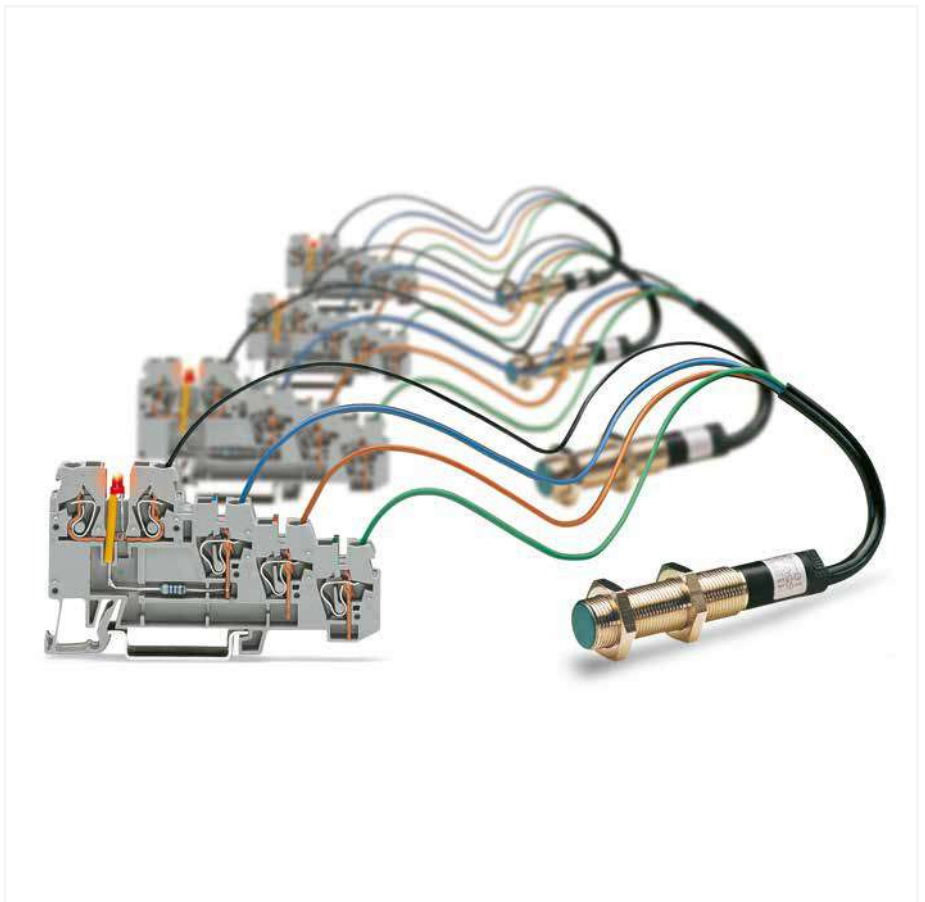

Marking strip (Item No. 709-196)
Not suitable for LED terminal blocks!

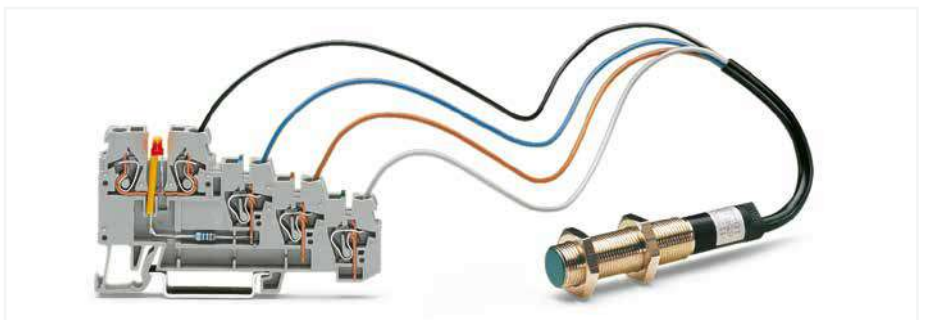

Sensor LED terminal block

CAGE CLAMP® terminates the following copper conductors:
solid "s" stranded "st"

fine-stranded "f-st", also with tinned single strands

fine-stranded, tip-bonded

fine-stranded, with ferrule (gastight crimped)

fine-stranded, with pin terminal (gastight crimped)

With ferruled conductors, it is necessary to use a terminal block one size smaller than the conductor's nominal cross section.

4-Conductor Sensor Terminal Block and 4-Conductor Sensor LED Terminal Block 2.5 mm²; 270 Series

Technical Data	
0.08 ... 2.5 mm ²	28 ... 12 AWG*
250 V / 4 kV / 3 ①	300 V, 20 A ②
I _N 18 A ②	300 V, 10 A ③
Terminal block width: 5 mm / 0.197 inch	
6 ... 7 mm / 0.24 ... 0.28 inch	

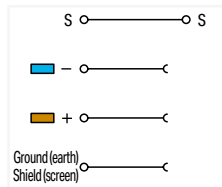
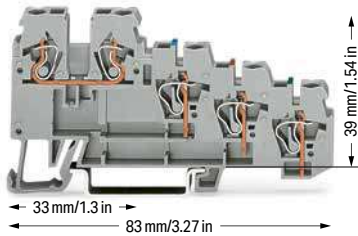

4-conductor sensor terminal block		
Color	Item No.	Pack. Unit
gray	270-570	50

Technical Data	
0.08 ... 2.5 mm ²	28 ... 12 AWG*
24 VDC ③	
Terminal block width: 5 mm / 0.197 inch	
6 ... 7 mm / 0.24 ... 0.28 inch	

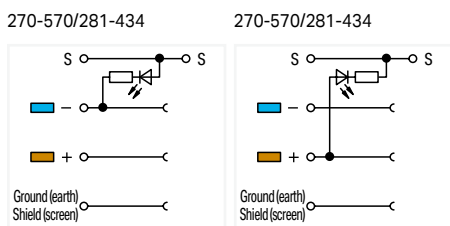
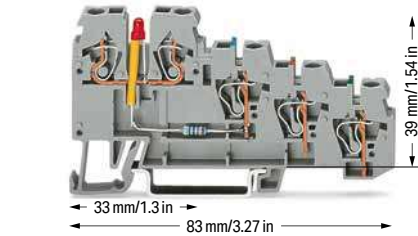

4-conductor sensor LED terminal block; for PNP (high-side) switching sensors; Red LED		
Color	Item No.	Pack. Unit
gray	270-570/281-434	50

4-conductor sensor LED terminal block; for NPN (low-side) switching sensors; Yellow LED		
Color	Item No.	Pack. Unit
gray	270-570/281-507	50

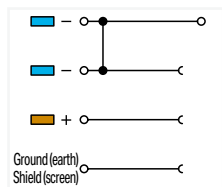
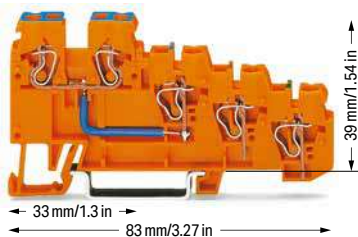

4-conductor sensor supply terminal block; Internal bridge: 9 A		
Color	Item No.	Pack. Unit
orange	270-574	10

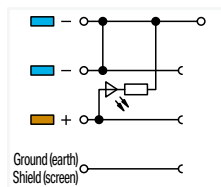
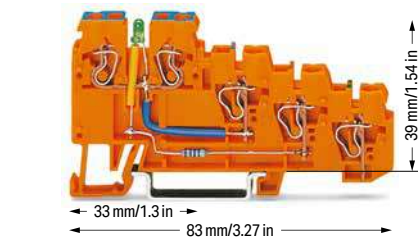

4-conductor sensor LED supply terminal block; Green LED		
Color	Item No.	Pack. Unit
orange	870-574/281-483	10

- *12 AWG: THHN, THWN
 - ① 250 V = rated voltage
4 kV = rated impulse voltage
3 = pollution degree (see Section 15)
 - ② Internal bridge: 9 A
 - ③ Other voltages are available upon request.
LED power consumption: 4.8 mA
- See application notes for:
Insulation stop, page 425
Marking, from page 684
- Approvals and corresponding ratings, visit www.wago.com

Accessories; 870 Series
Appropriate marking systems:
Mini-WSB/Mini-WSB Inline/WMB/WMB Inline

End and intermediate plate; 1 mm thick; for quadruple-deck terminal blocks

orange	270-322	100 (25)
gray	270-320	100 (25)

Insulation stop; 0.08 ... 0.2 mm² "s" (0.14 mm² "f-st"); 5 pcs/strip

white	280-470	200 (25)
-------	---------	----------

Insulation stop; 0.25 ... 0.5 mm²; 5 pcs/strip

light gray	280-471	200 (25)
------------	---------	----------

Insulation stop; 0.75 ... 1 mm²; 5 pcs/strip

dark gray	280-472	200 (25)
-----------	---------	----------

Push-in type jumper bar; uninsulated; I_N 18 A
Jumpers can be shortened using an electronic side cutter.

9-way	270-409	200 (25)
17-way	270-417	200 (25)
80-way	270-480	100 (25)

Push-in type jumper bar; insulated; I_N 18 A; light gray

2-way	870-402	200 (25)
3-way	870-403	200 (25)
4-way	870-404	100 (25)
5-way	870-405	100 (25)
6-way	870-406	100 (25)
7-way	870-407	100 (25)
8-way	870-408	100 (25)
9-way	870-409	50 (25)

Mini-WSB marking card; white; 10 strips with 10 markers/card; 5 mm wide markers

plain	248-501	5
-------	---------	---

WMB marking card; white; 10 strips with 10 markers/card; stretchable 5 ... 5.2 mm

plain	793-5501	5
-------	----------	---

Operating tool with a partially insulated shaft; Type 2; (3.5 x 0.5) mm blade

	210-720	1
--	---------	---

3-Conductor Sensor Terminal Block and 3-Conductor Sensor LED Terminal Block 2.5 mm²; 270 Series

Technical Data

0.08 ... 2.5 mm ²	28 ... 12 AWG*
250 V / 4 kV / 3 ①	300 V, 20 A ②
I _N 18 A ②	300 V, 10 A ③
Terminal block width: 5 mm / 0.197 inch	
6 ... 7 mm / 0.24 ... 0.28 inch	

Technical Data

0.08 ... 2.5 mm ²	28 ... 12 AWG*
24 VDC ③	
Terminal block width: 5 mm / 0.197 inch	
6 ... 7 mm / 0.24 ... 0.28 inch	

Technical Data

0.08 ... 2.5 mm ²	28 ... 12 AWG*
24 VDC ③	
Terminal block width: 5 mm / 0.197 inch	
6 ... 7 mm / 0.24 ... 0.28 inch	

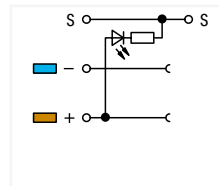
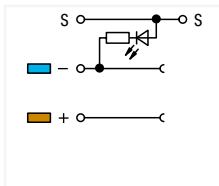
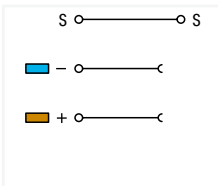
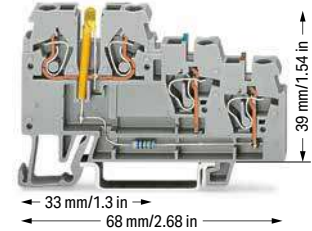
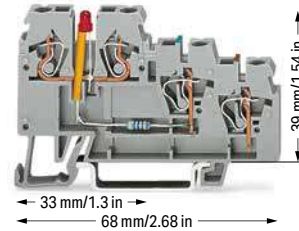
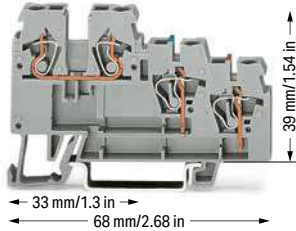

3-conductor sensor terminal block

Color	Item No.	Pack. Unit
○ gray	270-560	50

3-conductor sensor LED terminal block; for PNP (high-side) switching sensors; Red LED

Color	Item No.	Pack. Unit
○ gray	270-560/281-434	50

3-conductor sensor LED terminal block; for NPN (low-side) switching sensors; Yellow LED

Color	Item No.	Pack. Unit
○ gray	270-560/281-507	50

8

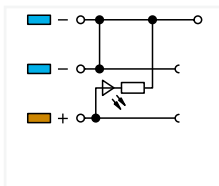
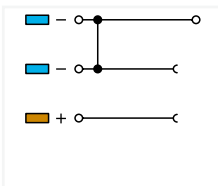
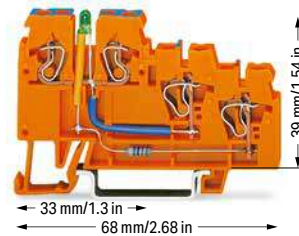
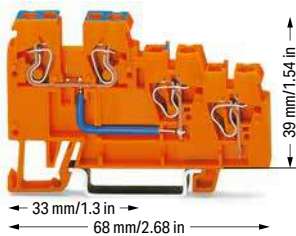

3-conductor sensor supply terminal block; Internal bridge: 9 A

Color	Item No.	Pack. Unit
○ gray	270-564	10

3-conductor sensor LED supply terminal block; Green LED

Color	Item No.	Pack. Unit
○ gray	270-564/281-483	10

Pluggable tap-off modules (Item No. 870-425, 870-426, 870-427) can be used on the signal level.

3-Conductor Actuator Terminal Block and 3-Conductor Actuator LED Terminal Block 2.5 mm²; 270 Series

Technical Data	
0.08 ... 2.5 mm ²	28 ... 12 AWG*
250 V / 4 kV / 3 ①	300 V, 20 A ②
I _N 18 A ②	300 V, 10 A ②
Terminal block width: 5 mm / 0.197 inch	
6 ... 7 mm / 0.24 ... 0.28 inch	

Technical Data	
0.08 ... 2.5 mm ²	28 ... 12 AWG*
24 VDC ③	
Terminal block width: 5 mm / 0.197 inch	
6 ... 7 mm / 0.24 ... 0.28 inch	

*12 AWG: THHN, THWN
① 250 V = rated voltage 4 kV = rated impulse voltage 3 = pollution degree (see Section 15)
② Other voltages are available upon request. LED power consumption: 4.8 mA
See application notes for: Insulation stop, page 425 Marking, from page 684
Approvals and corresponding ratings, visit www.wago.com

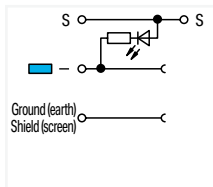
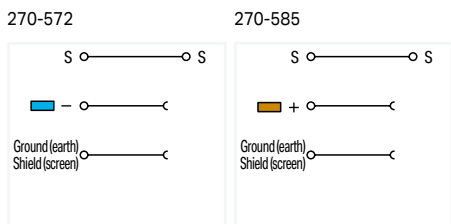
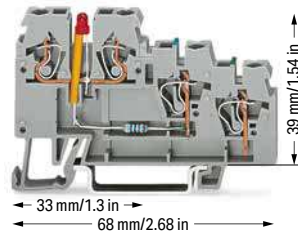
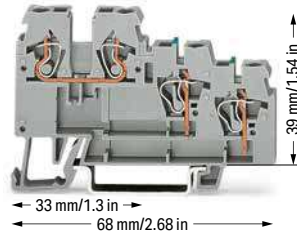

3-conductor actuator terminal block		
Color	Item No.	Pack. Unit
gray	270-572	50

3-conductor actuator LED terminal block; for PNP (high-side) switching actuators; Red LED		
Color	Item No.	Pack. Unit
gray	270-572/281-434	50

3-conductor actuator terminal block		
Color	Item No.	Pack. Unit
gray	270-585	50

Accessories; 870 Series
Appropriate marking systems:
Mini-WSB/Mini-WSB Inline/WMB/WMB Inline

End and intermediate plate; 1 mm thick; for triple-deck terminal blocks			
orange	270-321	100 (25)	
gray	270-319	100 (25)	

Insulation stop; 0.08 ... 0.2 mm ² "s" (0.14 mm ² "f-st"); 5 pcs/strip			
white	280-470	200 (25)	

Insulation stop; 0.25 ... 0.5 mm ² ; 5 pcs/strip			
light gray	280-471	200 (25)	

Insulation stop; 0.75 ... 1 mm ² ; 5 pcs/strip			
dark gray	280-472	200 (25)	

Push-in type jumper bar; uninsulated; I_N 18 A
Jumpers can be shortened using an electronic side cutter.

9-way	270-409	200 (25)
17-way	270-417	200 (25)
80-way	270-480	100 (25)

Push-in type jumper bar; insulated; I _N 18 A; light gray			
2-way	870-402	200 (25)	
3-way	870-403	200 (25)	
4-way	870-404	100 (25)	
5-way	870-405	100 (25)	
6-way	870-406	100 (25)	
7-way	870-407	100 (25)	
8-way	870-408	100 (25)	
9-way	870-409	50 (25)	

Mini-WSB marking card; white; 10 strips with 10 markers/card; 5 mm wide markers			
plain	248-501	5	

WMB marking card; white; 10 strips with 10 markers/card; stretchable 5 ... 5.2 mm			
plain	793-5501	5	

Operating tool with a partially insulated shaft; Type 2; (3.5 x 0.5) mm blade

	210-720	1
--	---------	---

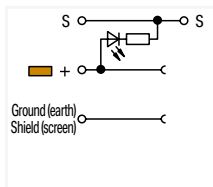
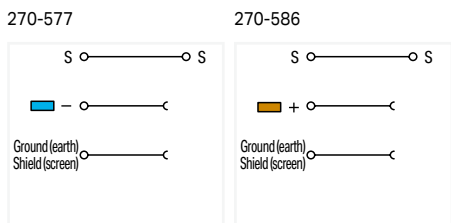
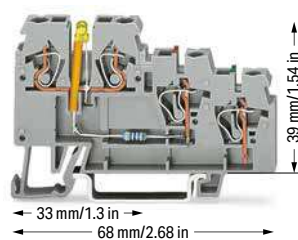
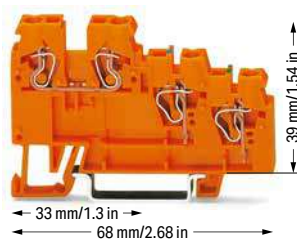

3-conductor actuator supply terminal block		
Color	Item No.	Pack. Unit
orange	270-577	10





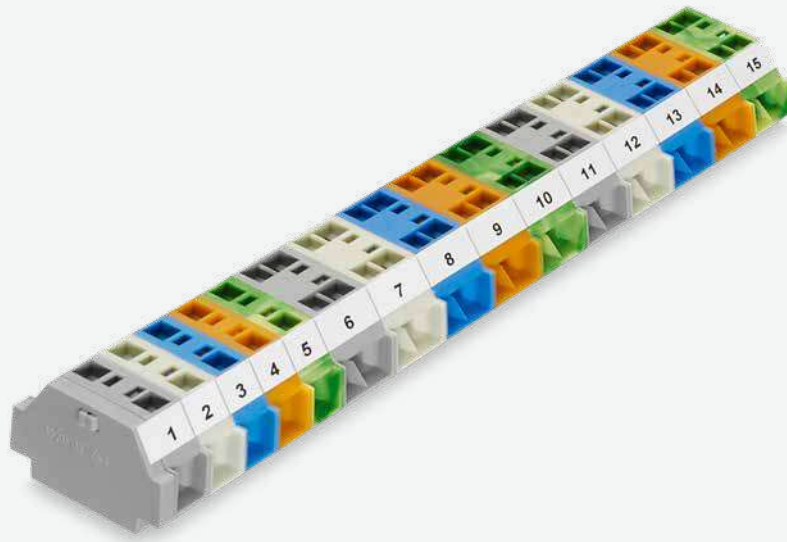

3-conductor actuator LED terminal block; for NPN (low-side) switching actuators; Yellow LED		
Color	Item No.	Pack. Unit
gray	270-585/281-507	50

3-conductor actuator supply terminal block		
Color	Item No.	Pack. Unit
orange	270-586	10



WAGO Modular Terminal Blocks and WAGO Terminal Strips

WAGO Modular Terminal Blocks and WAGO Terminal Strips

			Page
	Modular Terminal Blocks and Terminal Strips; with Mounting Flanges or Snap-In Mounting Feet – Front-Entry Wiring 2.5 (4 "f-st") mm ² (12 AWG)	869 Series	527
	Modular Terminal Blocks and Terminal Strips; with Mounting Flanges or Snap-In Mounting Feet – Front-Entry Wiring 2.5 mm ² (14 AWG)	264 Series	532
	Modular Terminal Blocks and Terminal Strips; with Mounting Flanges or Snap-In Mounting Feet – Side-Entry Wiring 0.08 ... 1.5 mm ² (28 ... 16 AWG) / 2.5 mm ² (14 AWG) / 4 mm ² (12 AWG)	260/261/262 Series	538
	Modular Terminal Blocks and Terminal Strips; with Push-Buttons on One or Both Sides 0.08 ... 1.5 mm ² (28 ... 16 AWG)	261 Series	542
	Modular Terminal Blocks and Terminal Strips with Mini-WSB Marker Slot and Push-Buttons on One or Both Sides 1.5 mm ² (16 AWG)	261 Series	546
	Accessories for Modular Terminal Blocks and Terminal Strips	260/261/262 Series	552

Modular Terminal Blocks and Terminal Strips

869 Series

Description and Installation

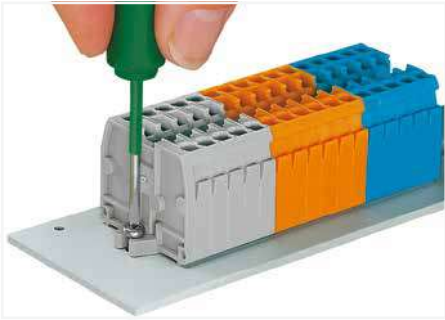

Mounting and securing a terminal strip directly to the plate via screw-type flanges.

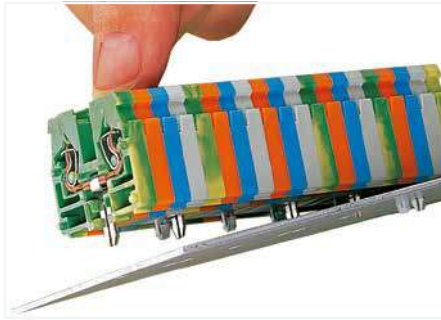

Mounting a terminal strip with snap-in feet into holes.

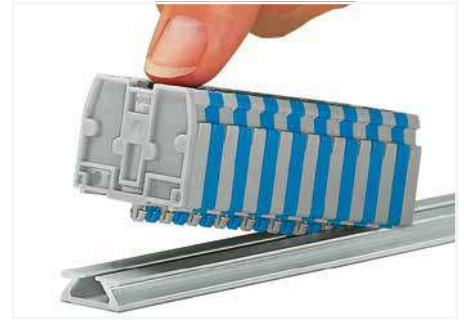

Mounting a terminal strip with snap-in feet onto the aluminum rail.

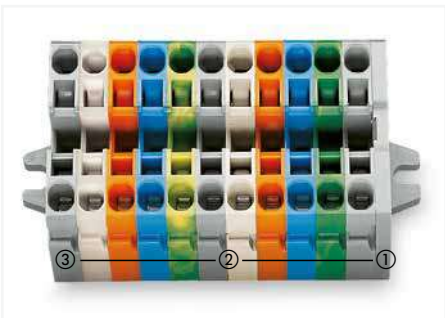

Terminal strip with mounting flanges:

- End plate with mounting flange ①
- Center terminal blocks ②
- End terminal block with mounting flange ③

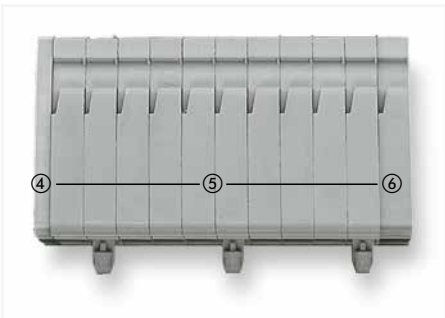

Terminal strip with snap-in mounting feet:

- End plate ④
- Center terminal blocks with/without snap-in mounting feet ⑤
- End terminal block with/without snap-in mounting foot ⑥



9



WMB markers in Mini-WSB marker slots
Translucent marking strip
Mini-WSB markers



Push jumper bars down firmly until fully inserted. When using multipole bars, push alternately on the right and then left side until installed.
Push-in type jumper bars 1-3-5-7 or 1-4-7 are available upon request.



Protective warning marker (280-405); with a black high-voltage symbol

CAGE CLAMP® terminates the following copper conductors:
solid "s" stranded "st"

fine-stranded "f-st",
also with tinned
single strands

fine-stranded,
tip-bonded

fine-stranded,
with ferrule
(gastight crimped)

fine-stranded,
with pin terminal
(gastight crimped)

With ferruled conductors, it is necessary to use a terminal block one size smaller than the conductor's nominal cross section.

Compact Terminal Strips; with Mounting Flanges or Snap-in Mounting Feet

2.5 (4 "f-st") mm²; 870 Series

Technical Data	
0.08 ... 2.5 (4 "f-st") mm ²	28 ... 12 AWG
500 V / 6 kV / 3	300 V, 20 A:
I _N 24 A	
Pole width: 5 mm / 0.197 inch	
6 ... 7 mm / 0.24 ... 0.28 inch	

Technical Data	
0.08 ... 2.5 (4 "f-st") mm ² ①	28 ... 12 AWG
500 V / 6 kV / 3 ②	300 V, 20 A:
I _N 24 A	
Pole width: 5 mm / 0.197 inch	
6 ... 7 mm / 0.24 ... 0.28 inch	

Technical Data	
0.08 ... 2.5 (4 "f-st") mm ² ①	28 ... 12 AWG
500 V / 6 kV / 3 ②	300 V, 20 A:
I _N 24 A	
Pole width: 5 mm / 0.197 inch	
6 ... 7 mm / 0.24 ... 0.28 inch	



Compact terminal strip; with M3 mounting flanges; for screw or similar mounting types; 3.2 mm mounting hole diameter; gray

Pole No.	Item No.	Pack. Unit
○ 2	869-102	100
○ 3	869-103	100
○ 4	869-104	100
○ 5	869-105	100
○ 6	869-106	50
○ 7	869-107	50
○ 8	869-108	50
○ 9	869-109	50
○ 10	869-110	50
○ 11	869-111	25
○ 12 ①	869-112	25

Compact terminal strip; with M4 mounting flanges; for screw or similar mounting types; 4.2 mm mounting hole diameter; gray

Pole No.	Item No.	Pack. Unit
○ 2	869-202	100
○ 3	869-203	100
○ 4	869-204	100
○ 5	869-205	100
○ 6	869-206	50
○ 7	869-207	50
○ 8	869-208	50
○ 9	869-209	50
○ 10	869-210	25
○ 11	869-211	25
○ 12 ①	869-212	25

Compact terminal strip; with snap-in mounting feet; for 0.6 ... 1.2 mm plate thickness; 3.5 + 0.1 mm mounting hole diameter; gray

Pole No.	Item No.	Pack. Unit
○ 2	869-152	100
○ 3	869-153	100
○ 4	869-154	100
○ 5	869-155	100
○ 6	869-156	50
○ 7	869-157	50
○ 8	869-158	50
○ 9	869-159	50
○ 10	869-160	25
○ 11	869-161	25
○ 12 ①	869-162	25

light gray		
○ 2	869-132	100
○ 3	869-133	100
○ 4	869-134	100
○ 5	869-135	100
○ 6	869-136	50
○ 7	869-137	50
○ 8	869-138	50
○ 9	869-139	50
○ 10	869-140	25
○ 11	869-141	25
○ 12 ①	869-142	25

light gray		
○ 2	869-232	100
○ 3	869-233	100
○ 4	869-234	100
○ 5	869-235	100
○ 6	869-236	50
○ 7	869-237	50
○ 8	869-238	50
○ 9	869-239	50
○ 10	869-240	25
○ 11	869-241	25
○ 12 ①	869-242	25

light gray		
○ 2	869-182	100
○ 3	869-183	100
○ 4	869-184	100
○ 5	869-185	100
○ 6	869-186	50
○ 7	869-187	50
○ 8	869-188	50
○ 9	869-189	50
○ 10	869-190	25
○ 11	869-191	25
○ 12 ①	869-192	25

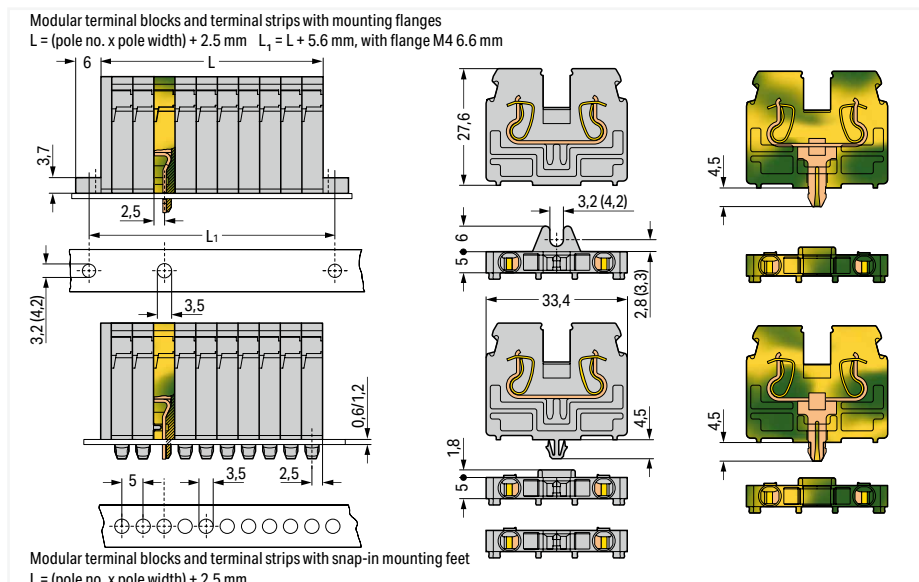

- ① Longer strips and/or mixed-color assemblies are available upon request.
- Item no. suffixes for gray terminal strips in:
 - blue .../000-006 ②
 - green-yellow .../000-016
 - 869-102 ... 869-112
 - 869-202 ... 869-212
 - 869-152 ... 869-162
- ② Terminal strips with a blue insulated housing are suitable for Ex i applications.

Dimensions in mm

Modular Terminal Block; with Mounting Flange or Snap-In Mounting Foot

2.5 (4 "f-st") mm²; 870 Series

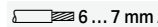
Technical Data	
0.08 ... 2.5 (4 "f-st") mm ² ①	28 ... 12 AWG
500 V / 6 kV / 3 ②	300 V, 20 A I_N
I_N 24 A	
Terminal block width: 5 mm / 0.197 inch	
 6 ... 7 mm / 0.24 ... 0.28 inch	

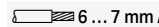
Technical Data	
0.08 ... 2.5 (4 "f-st") mm ² ①	28 ... 12 AWG
500 V / 6 kV / 3 ②	300 V, 20 A I_N
I_N 24 A	
Terminal block width: 5 mm / 0.197 inch	
 6 ... 7 mm / 0.24 ... 0.28 inch	

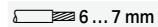
Technical Data	
0.08 ... 2.5 (4 "f-st") mm ² ①	28 ... 12 AWG
500 V / 6 kV / 3 ②	300 V, 20 A I_N
I_N 24 A	
Terminal block width: 5 mm / 0.197 inch	
 6 ... 7 mm / 0.24 ... 0.28 inch	

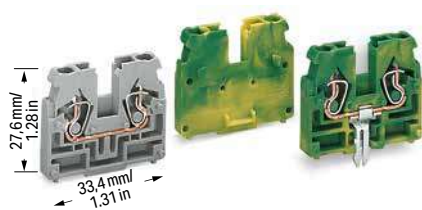

Center terminal block; without snap-in mounting foot; for 0.6 ... 1.2 mm plate thickness; required between end plate and end terminal block for terminal strips with mounting flanges

Color	Item No.	Pack. Unit
gray	869-321	100
blue	869-324 ③	100
orange	869-326	100
green-yellow	869-327	100
light gray	869-329	100

End terminal block; with M3 mounting flange; for screw or similar mounting types; 3.2 mm mounting hole diameter

Color	Item No.	Pack. Unit
gray	869-301	100
blue	869-304 ③	100
green-yellow	869-307	100
light gray	869-309	100

End terminal block; with snap-in mounting foot; for 0.6 ... 1.2 mm plate thickness; 3.5 + 0.1 mm mounting hole diameter

Color	Item No.	Pack. Unit
gray	869-331	100
blue	869-334 ③	100
green-yellow	869-337	100
light gray	869-339	100

Center terminal block; with direct ground contact; 3.5 + 0.1 mm drilled hole diameter; required between end plate and end terminal block for terminal strips with mounting flanges

Notice: Terminal block cannot be commoned!

green-yellow	869-328	100
--------------	---------	-----

End terminal block; with M4 mounting flange; for screw or similar mounting types; 4.2 mm mounting hole diameter

Color	Item No.	Pack. Unit
gray	869-351	100
blue	869-354 ③	100
green-yellow	869-357	100
light gray	869-359	100

End terminal block; without snap-in mounting foot; for 0.6 ... 1.2 mm plate thickness

Color	Item No.	Pack. Unit
gray	869-341	100
blue	869-344 ③	100
green-yellow	869-347	100
light gray	869-349	100

Accessories; item-specific

Aluminum mounting rail; 1000 mm long; 18 mm wide; 7 mm high

210-154	1
---------	---



Plastic end stop; with WSB marker slot; for aluminum rail (210-154); 6 mm wide

209-122	25
---------	----



Accessories; 869 Series

Appropriate marking systems: Mini-WSB/Mini-WSB Inline/WMB/WMB Inline

End plate; with M3 mounting flange; 2.5 mm thick

gray	869-385	100 (25)
blue	869-388	100 (25)
green-yellow	869-389	100 (25)
light gray	869-387	100 (25)

End plate; with M4 mounting flange; 2.5 mm thick

gray	869-395	100 (25)
blue	869-398	100 (25)
green-yellow	869-399	100 (25)
light gray	869-397	100 (25)

End plate; for terminal blocks with snap-in mounting foot; 2.5 mm thick

gray	869-375	100 (25)
blue	869-378	100 (25)
green-yellow	869-379	100 (25)
light gray	869-377	100 (25)

Insulation stop; 0.08 ... 0.2 mm² "s" (0.14 mm² "f-st"); 5 pcs/strip

white	280-470	200 (25)
-------	---------	----------

Insulation stop; 0.25 ... 0.5 mm²; 5 pcs/strip

light gray	280-471	200 (25)
------------	---------	----------

Insulation stop; 0.75 ... 1 mm²; 5 pcs/strip

dark gray	280-472	200 (25)
-----------	---------	----------

Protective warning marker; with black high-voltage symbol; for 5 terminal blocks

yellow	280-405	100 (25)
--------	---------	----------

Push-in type jumper bar; insulated; I_N 18 A; light gray

2-way	870-402	200 (25)
3-way	870-403	200 (25)
4-way	870-404	100 (25)
5-way	870-405	100 (25)
6-way	870-406	100 (25)
7-way	870-407	100 (25)
8-way	870-408	100 (25)
9-way	870-409	100 (25)
10-way	870-410	50 (25)

Test plug; with 500 mm cable; 2 mm Ø; max. 42 V

red	210-136	50
-----	---------	----



Technical Data

0.08 ... 2.5 (4 "f-st") mm ² ①	28 ... 12 AWG
500 V / 6 kV / 3 ②	300 V, 20 A, I_{th}
I_N 24 A	
Terminal block width: 5 mm / 0.197 inch	
6 ... 7 mm / 0.24 ... 0.28 inch	



Center terminal block; with snap-in mounting foot; for 0.6 ... 1.2 mm plate thickness; 3.5 + 0.1 mm mounting hole diameter

Color	Item No.	Pack. Unit
gray	869-311	100
blue	869-314 ③	100
orange	869-316	100
green-yellow	869-317	100
light gray	869-319	100

- ① Max. insulation diameter: 4.4 mm
 - ② 500 V = rated voltage
6 kV = rated impulse voltage
3 = pollution degree (see Section 15)
 - ③ Terminal blocks with a blue insulated housing are suitable for Ex i applications.
- See application notes for:
Insulation stop, page 425
Group marker carrier, page 513
- Approvals and corresponding ratings, visit www.wago.com

Accessories; 869 Series
Appropriate marking systems:
Mini-WSB/Mini-WSB Inline/WMB/WMB Inline

Mini-WSB Inline, plain; 1,700 WMB markers (5 mm)/reel; 5 ... 5.2 mm stretchable

white	2009-145	1
-------	----------	---

Mini-WSB marking card; white; 10 strips with 10 markers/card; 5 mm wide markers

plain	248-501	5
-------	---------	---

Group marker carrier; fits into the jumper slot of the current bars

gray	870-184	50 (25)
------	---------	---------

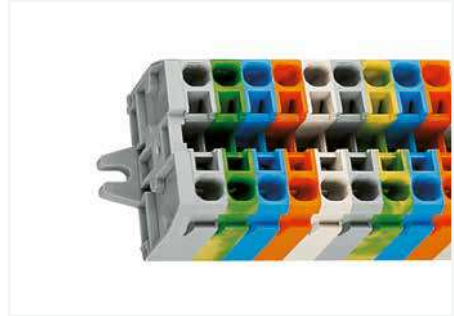

Terminal strip; with M3 or M4 mounting flanges; for screw or similar mounting types
Mounting holes:
3.2 mm Ø; M3 flange
4.2 mm Ø; M4 flange

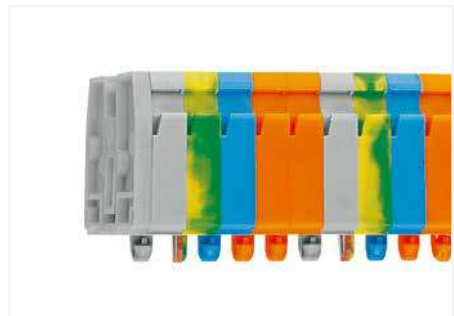

Terminal strips with snap-in mounting feet; for 0.6 ... 1.2 mm plate thickness; mounting holes: 3.5^{+0.1} mm Ø

Accessories; item-specific

Aluminum mounting rail; 1000 mm long; 18 mm wide; 7 mm high

	210-154	1
--	---------	---

Plastic end stop; with WSB marker slot; for aluminum rail (210-154); 6 mm wide

	209-122	25
--	---------	----



Inserting insulation stops into conductor entry holes of terminal strip.

The wiring of programmable logic controllers and micro-processor-operated control circuits often relies on very small, fine-stranded conductors. These conductors are highly flexible and deform when pushed against the conductor stop in terminal blocks. As a result, the conductor insulation – not the copper conductor – may be clamped, causing intermittent contact or no contact at all. Common to all terminal block types currently offered, this problem creates unnecessary downtime for troubleshooting.

The solution: an insulation stop for compact terminal blocks. Insulation stops automatically bundle the cores of fine-stranded conductors when inserted into the clamping unit, preventing splaying. This also limits the conductor entry to a defined cross sectional area – ensuring the actual conductor, not the insulation, will enter the clamping unit

The insulation stop is available as dividable 5-pole strip for the 869 Series Terminal Strips.

Insulation stop usage will not affect the conductor strip lengths for the aforementioned terminal strips.

Push-in type jumper bar; insulated; I_N 18 A; light gray

1 to 3	870-433	200 (25)
1 to 4	870-434	200 (25)
1 to 5	870-435	100 (25)
1 to 6	870-436	100 (25)
1 to 7	870-437	100 (25)
1 to 8	870-438	100 (25)
1 to 9	870-439	100 (25)
1 to 10	870-440	50 (25)

Marking strip; plain; 7.5 mm wide; 1 m long

translucent	709-196	1
-------------	---------	---



Modular Terminal Blocks and Terminal Strips

264 Series

Description and Installation

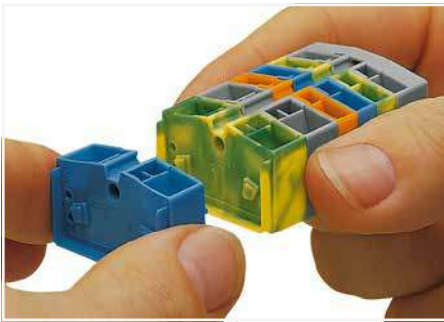

Assembling modular terminal blocks into terminal strips.



Mounting an "end terminal block" with mounting flange.

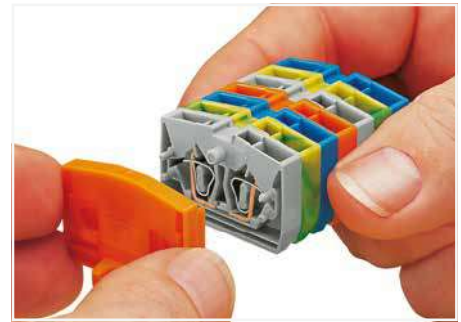

Mounting an end plate.



CAGE CLAMP® termination:
Inserting a conductor.
With ferruled conductors, it is necessary to use a terminal block one size smaller than the conductor's nominal cross section.

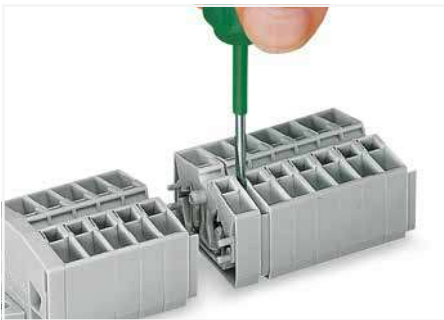

Removing a terminal block.

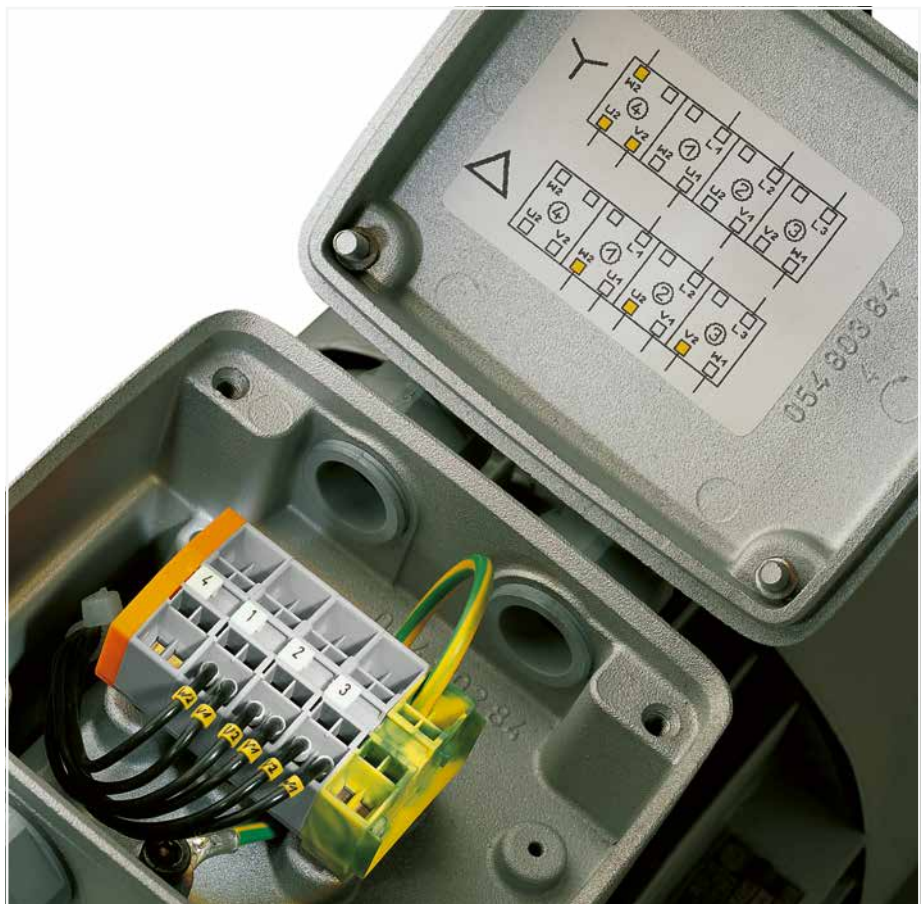

9



Commoning with comb-style jumper bar.



Marking with T-marker tag (209-290).



Combining 2- and 4-conductor terminal blocks.
Marking via Mini-WSB Quick Marking System.



CAGE CLAMP® terminates the following copper conductors:
solid "s"



stranded "st"



fine-stranded "f-st",
also with tinned
single strands



Mounting and securing a terminal strip directly to the plate via screw-type flanges.

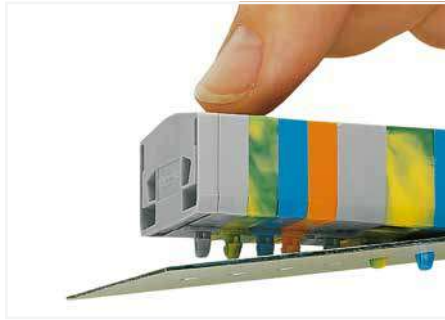

Mounting a terminal strip with snap-in feet into holes.



Mounting a terminal strip with snap-in feet onto the aluminum mounting rail.

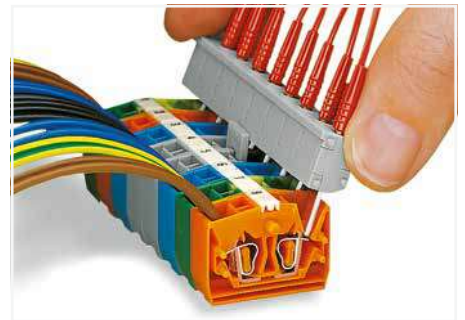
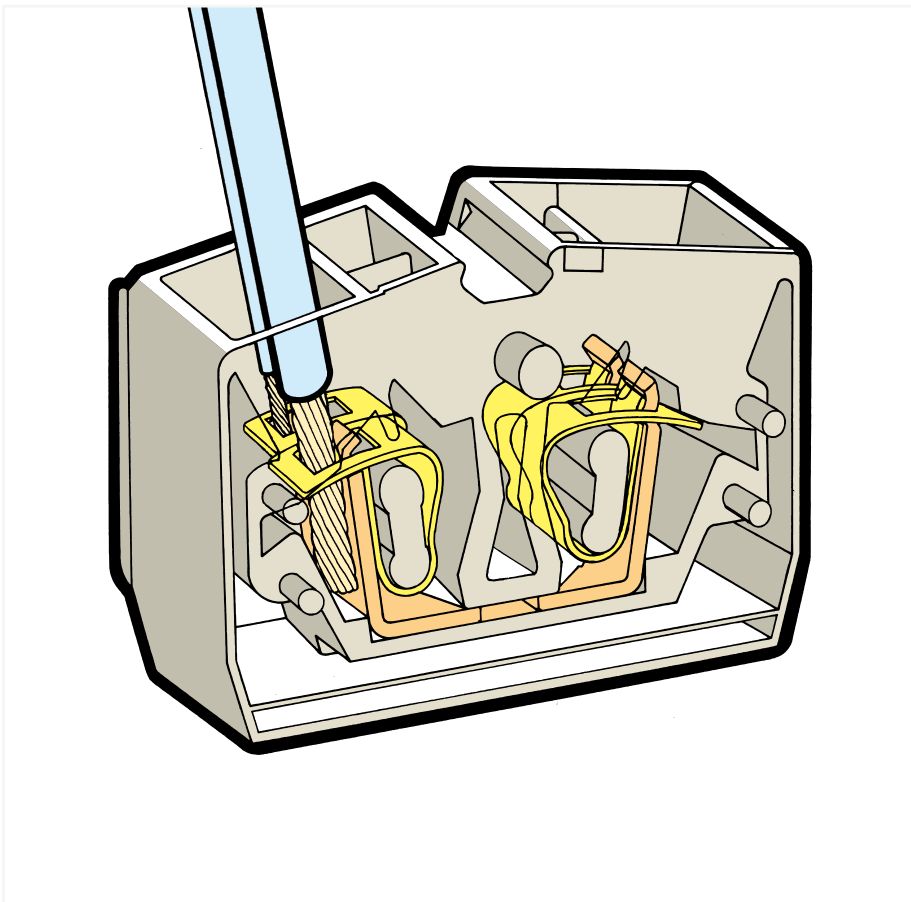

Testing by touch contact to the CAGE CLAMP® spring (limited to 0.5 A and 48 V test voltage) – test pins are not protected against accidental contact.

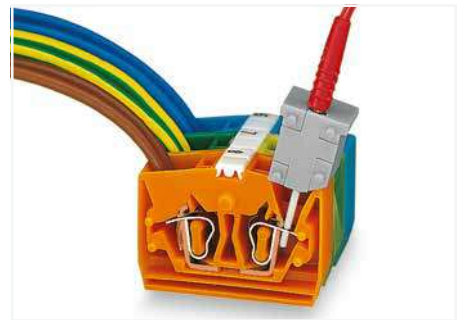

Testing via CAGE CLAMP® on the current bar (max. nominal current: 6 A). CAGE CLAMP® clamps individual test contacts. The maximum test voltage is 400 V.

9



Ex e II terminal strip; with mounting flanges; for screw or similar mounting types; 3.2 mm mounting hole diameter



Ex e II terminal strip; with snap-in mounting feet; for 0.6 ... 1.2 mm plate thickness; 3.5 mm mounting hole diameter



fine-stranded, tip-bonded



fine-stranded, with ferrule (gastight crimped)



fine-stranded, with pin terminal (gastight crimped)

Modular Terminal Block; with Mounting Flange

2.5 mm²; 264 Series

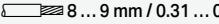
Technical Data	
0.08 ... 2.5 mm ²	28 ... 12 AWG*
800 V / 8 kV / 3 ①	300 V, 20 A ②
I _N 24 A	600 V, 20 A ③
Terminal block width: 6 mm / 0.236 inch	
 8 ... 9 mm / 0.31 ... 0.35 inch	

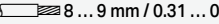
Technical Data	
0.08 ... 2.5 mm ²	28 ... 12 AWG*
800 V / 8 kV / 3 ①	300 V, 20 A ②
I _N 24 A	600 V, 20 A ③
Terminal block width: 10 mm / 0.394 inch	
 8 ... 9 mm / 0.31 ... 0.35 inch	



*12 AWG: THHN, THWN

- ① 800 V = rated voltage
8 kV = rated impulse voltage
3 = pollution degree
(see Section 15)
- ② Terminal blocks with a blue insulated housing are suitable for Ex i applications.
- ③ Terminal blocks with an Ex mark are suitable for Ex e II applications.
0.5 ... 2.5 mm² / 20 ... 12 AWG*
690 V; 23 A
(see Section 15)

See application notes for:
Alternate comb-style jumper bar, page 426
Test plug module, page 420
Mini-WSB marking system, page 684

Approvals and corresponding ratings, visit www.wago.com

2-conductor center terminal block; required between end plate and end terminal block for terminal strips with mounting flanges

Color	Item No.	Pack. Unit
gray	264-321	100
blue	264-324 ②	100
orange	264-326	100
green-yellow	264-327	100
light gray ③	264-131 ③	100

4-conductor center terminal block; required between end plate and end terminal block for terminal strips with mounting flanges

Color	Item No.	Pack. Unit
gray	264-351	100
blue	264-354 ②	100
orange	264-356	100
green-yellow	264-357	100
light gray ③	264-231 ③	100

2-conductor end terminal block; with mounting flange; for screw or similar mounting types; 3.2 mm mounting hole diameter

gray	264-301	100
blue	264-304 ②	100
orange	264-306	100
green-yellow	264-307	100
light gray ③	264-130 ③	100

4-conductor end terminal block; with mounting flange; for screw or similar mounting types; 3.2 mm mounting hole diameter

gray	264-331	100
blue	264-334 ②	100
orange	264-336	100
green-yellow	264-337	100
light gray ③	264-230 ③	100

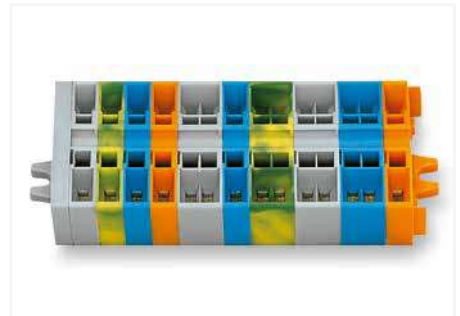

- Terminal strip with mounting flanges, consisting of:
- End plate; with mounting flange
 - Center terminal blocks
 - End terminal block; with mounting flange

Accessories; item-specific

Alternate comb-style jumper bar; insulated; I_N = I_N of terminal block

	2-way	281-492	100 (25)
---	-------	---------	----------

Accessories; item-specific

Alternate comb-style jumper bar; insulated; I_N = I_N of terminal block

	2-way	280-492	200 (25)
---	-------	---------	----------

Test plug module; snaps together; 6 mm wide

	gray	249-136	100 (25)
---	------	---------	----------

Test plug module; snaps together; 10 mm wide

	gray	249-139	100 (25)
---	------	---------	----------

Mini-WSB marking card; white; 10 strips with 10 markers/ card; 5 mm wide markers

	plain	248-501	5
--	-------	---------	---

Mini-WSB marking card; white; 10 strips with 10 markers/ card; 5 mm wide markers

		264-900	5
---	--	---------	---

Accessories; 264 Series

Appropriate marking systems: Mini-WSB/Mini-WSB Inline/T-marker tag

End and intermediate plate; 4 mm thick

	gray	264-361	25
	orange	264-364	25
	light gray	264-363	25

Test plug; with 500 mm cable; 2 mm Ø; max. 42 V

	red	210-136	50
---	-----	---------	----

Comb-style jumper bar; insulated; reduces maximum conductor size to 1.5 mm²; I_N 16 A; gray

	2-way	264-402	200 (25)
---	-------	---------	----------

T-marker tag; 30 markers per tag; up to 6 characters per marker; stretchable 5 ... 6 mm

	plain	209-290	50
---	-------	---------	----

Operating tool; insulated

	2-way	280-432	1
---	-------	---------	---

Mini-WSB marking card; white; 10 strips with 10 markers/ card; 5 mm wide markers

	plain	248-501	5
---	-------	---------	---

Modular Terminal Block; with Snap-In Mounting Foot

2.5 mm²; 264 Series

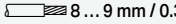
Technical Data	
0.08 ... 2.5 mm ²	28 ... 12 AWG*
800 V / 8 kV / 3 ①	300 V, 20 A ②
I _N 24 A	600 V, 20 A ③
Terminal block width: 6 mm / 0.236 inch	
 8 ... 9 mm / 0.31 ... 0.35 inch	

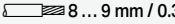
Technical Data	
0.08 ... 2.5 mm ²	28 ... 12 AWG*
800 V / 8 kV / 3 ①	300 V, 20 A ②
I _N 24 A	600 V, 20 A ③
Terminal block width: 10 mm / 0.394 inch	
 8 ... 9 mm / 0.31 ... 0.35 inch	

*12 AWG: THHN, THWN





- ① 800 V = rated voltage
8 kV = rated impulse voltage
3 = pollution degree
(see Section 15)
- ② Terminal blocks with a blue insulated housing are suitable for Ex i applications.
- ③ Terminal blocks with an Ex mark are suitable for Ex e II applications.
0.5 ... 2.5 mm² / 20 ... 12 AWG*
690 V; 23 A
(see Section 15)

See application notes for:
Alternate comb-style jumper bar, page 426
Test plug module, page 420
Mini-WSB marking system, page 684

Approvals and corresponding ratings, visit www.wago.com



2-conductor terminal block; with snap-in mounting foot; for 0.6 ... 1.2 mm plate thickness; 3.5 mm mounting hole diameter

Color	Item No.	Pack. Unit
 gray	264-311	100
 blue	264-314 ②	100
 orange	264-316	100
 green-yellow	264-317	100
 light gray ③	264-180 ③	100

4-conductor terminal block; with snap-in mounting foot; for 0.6 ... 1.2 mm plate thickness; 3.5 mm mounting hole diameter

Color	Item No.	Pack. Unit
 gray	264-341	100
 blue	264-344 ②	100
 orange	264-346	100
 green-yellow	264-347	100
 light gray ③	264-280 ③	100

Accessories; item-specific

Alternate comb-style jumper bar; insulated; I_N = I_N of terminal block

	2-way	281-492	100 (25)
---	-------	---------	----------

Test plug module; snaps together; 6 mm wide

	gray	249-136	100 (25)
---	------	---------	----------

Mini-WSB marking card; white; 10 strips with 10 markers/card; 5 mm wide markers

	plain	248-501	5
---	-------	---------	---

Accessories; item-specific

Alternate comb-style jumper bar; insulated; I_N = I_N of terminal block

	2-way	280-492	200 (25)
---	-------	---------	----------

Test plug module; snaps together; 10 mm wide

	gray	249-139	100 (25)
---	------	---------	----------

Mini-WSB marking card; white; 10 strips with 10 markers/card; 5 mm wide markers

		264-900	5
---	--	---------	---



Terminal strip with mounting flanges, consisting of:
End plate

- 4-conductor terminal strip; with snap-in mounting foot 1)
 - Center terminal blocks
 - 2-conductor terminal strip; with snap-in mounting foot 1)
- 1) at every 4th or 5th terminal block of the strip

Accessories; 264 Series

Appropriate marking systems: Mini-WSB/Mini-WSB Inline/T-marker tag

End and intermediate plate; 4 mm thick

	gray	264-371	25
	orange	264-374	25
	light gray	264-373	25

Comb-style jumper bar; insulated; reduces maximum conductor size to 1.5 mm²; I_N 16 A; gray

	2-way	264-402	200 (25)
---	-------	---------	----------

Operating tool; insulated

	2-way	280-432	1
---	-------	---------	---

Test plug; with 500 mm cable; 2 mm Ø; max. 42 V

	red	210-136	50
---	-----	---------	----

Aluminum mounting rail; 1000 mm long; 18 mm wide; 7 mm high

		210-154	1
---	--	---------	---

Plastic end stop; with WSB marker slot; for aluminum mounting rail (210-154); 6 mm wide

		209-122	25
---	--	---------	----

T-marker tag; 30 markers per tag; up to 6 characters per marker; stretchable 5 ... 6 mm

	plain	209-290	50
---	-------	---------	----

Mini-WSB Inline, plain; 1,700 WMB markers (5 mm)/reel; 5 ... 5.2 mm stretchable

	white	2009-145	1
---	-------	----------	---

Mini-WSB marking card; white; 10 strips with 10 markers/card; 5 mm wide markers

	plain	248-501	5
---	-------	---------	---

Operating tool with a partially insulated shaft; Type 2; (3.5 x 0.5) mm blade

		210-720	1
---	--	---------	---

Terminal Strip; with Mounting Flanges or Snap-in Mounting Feet 2.5 mm²; 264 Series

Technical Data

0.08 ... 2.5 mm ²	28 ... 12 AWG*
800 V / 8 kV / 3 ①	300 V, 20 A ②
I _N 24 A	600 V, 20 A ③
Pole width: 6 mm / 0.236 inch	
8 ... 9 mm / 0.31 ... 0.35 inch	

Technical Data

0.08 ... 2.5 mm ²	28 ... 12 AWG*
800 V / 8 kV / 3 ①	300 V, 20 A ②
I _N 24 A	600 V, 20 A ③
Pole width: 10 mm / 0.394 inch	
8 ... 9 mm / 0.31 ... 0.35 inch	

Technical Data

0.08 ... 2.5 mm ²	28 ... 12 AWG*
690 V ②	300 V, 20 A ②
I _N 23 A	600 V, 20 A ③
Pole width: 6 mm / 0.236 inch	
8 ... 9 mm / 0.31 ... 0.35 inch	

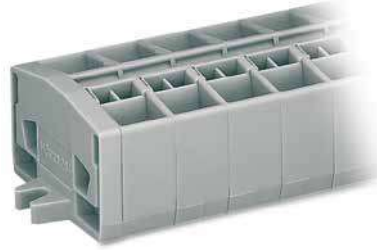

Dimensions in mm

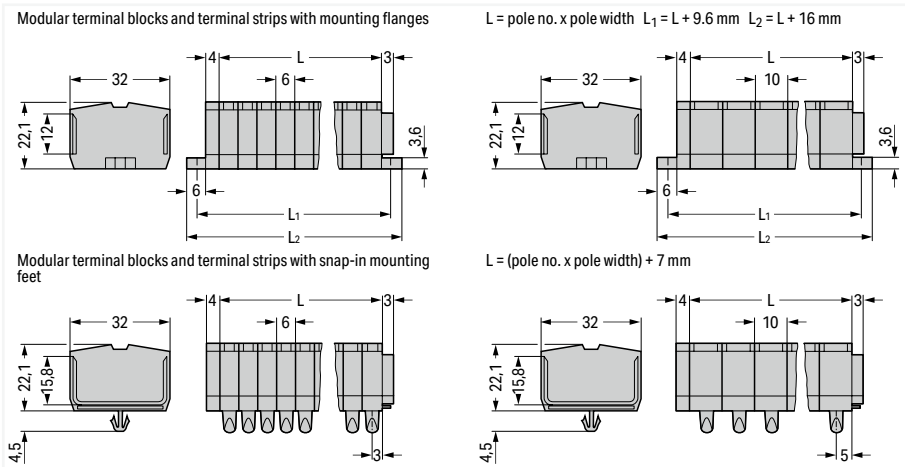

2-conductor terminal strip; with mounting flanges; for screw or similar mounting types; 3.2 mm mounting hole diameter; gray

Pole No.	Item No.	Pack. Unit
2	264-102	100
3	264-103	100
4	264-104	100
5	264-105	100
6	264-106	100
7	264-107	100
8	264-108	100
9	264-109	50
10	264-110	50
11	264-111	50
12 ③	264-112	25

4-conductor terminal strip; with mounting flanges; for screw or similar mounting types; 3.2 mm mounting hole diameter; gray

Pole No.	Item No.	Pack. Unit
2	264-202	100
3	264-203	100
4	264-204	100
5	264-205	100
6	264-206	100
7	264-207	100
8	264-208	100
9	264-209	50
10	264-210	50
11	264-211	25
12 ③	264-212	25

2-conductor Ex e II terminal strip; with mounting flanges; for screw or similar mounting types; 3.2 mm mounting hole diameter; light gray

Pole No.	Item No.	Pack. Unit
2 ②	264-132	100
3 ②	264-133	100
4 ②	264-134	100
5 ②	264-135	100
6 ②	264-136	100
7 ②	264-137	100
8 ②	264-138	100
9 ②	264-139	50
10 ②	264-140	50
11 ②	264-141	25
12 ② ③	264-142	25

2-conductor terminal strip; with snap-in mounting feet; for 0.6 ... 1.2 mm plate thickness; 3.5 mm mounting hole diameter; gray

Pole No.	Item No.	Pack. Unit
2	264-152	100
3	264-153	100
4	264-154	100
5	264-155	100
6	264-156	50
7	264-157	50
8	264-158	50
9	264-159	50
10	264-160	25
11	264-161	25
12 ③	264-162	25

4-conductor terminal strip; with snap-in mounting feet; for 0.6 ... 1.2 mm plate thickness; 3.5 mm mounting hole diameter; gray

Pole No.	Item No.	Pack. Unit
2	264-252	100
3	264-253	100
4	264-254	100
5	264-255	100
6	264-256	50
7	264-257	50
8	264-258	50
9	264-259	50
10	264-260	25
11	264-261	25
12 ③	264-262	25

2-conductor Ex e II terminal strip; with snap-in mounting feet; for 0.6 ... 1.2 mm plate thickness; 3.5 mm mounting hole diameter; light gray

Pole No.	Item No.	Pack. Unit
2 ②	264-182	100
3 ②	264-183	100
4 ②	264-184	100
5 ②	264-185	100
6 ②	264-186	50
7 ②	264-187	50
8 ②	264-188	50
9 ②	264-189	50
10 ②	264-190	25
11 ②	264-191	25
12 ② ③	264-192	25

Technical Data

0.08 ... 2.5 mm ²	28 ... 12 AWG*
690 V ②	300 V, 20 A ④
I _N 23 A	600 V, 20 A ⑥
Pole width: 10 mm / 0.394 inch	
8 ... 9 mm / 0.31 ... 0.35 inch	



- *12 AWG: THHN, THWN
- 800 V = rated voltage
8 kV = rated impulse voltage
3 = pollution degree
(see Section 15)
 - Suitable for Ex e II applications
(see Section 15)
 - Longer strips and/or mixed-color assemblies are available upon request.
- Approvals and corresponding ratings, visit www.wago.com

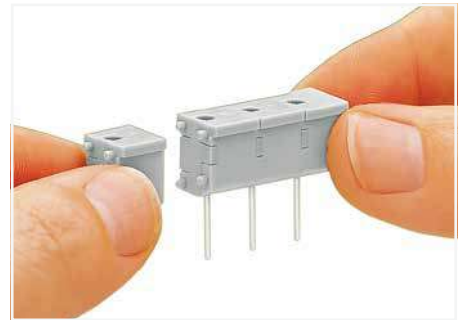

Snapping individual modules together to assemble a multi-pole test plug module.



Item no. suffixes for gray terminal strips with mounting flanges:
264-102 to 264-112
264-202 to 264-212

blue .../000-006,
Terminal strips with a blue insulated housing are suitable for Ex i applications.



Item no. suffixes for gray terminal strips with snap-in mounting feet:
264-152 to 264-162
264-252 to 264-262

blue .../000-006,
Terminal strips with a blue insulated housing are suitable for Ex i applications.

4-conductor Ex e II terminal strip; with mounting flanges; for screw or similar mounting types; 3.2 mm mounting hole diameter; light gray

Pole No.	Item No.	Pack. Unit
○ 2 ⑥	264-232	100
○ 3 ⑥	264-233	100
○ 4 ⑥	264-234	100
○ 5 ⑥	264-235	100
○ 6 ⑥	264-236	100
○ 7 ⑥	264-237	100
○ 8 ⑥	264-238	100
○ 9 ⑥	264-239	50
○ 10 ⑥	264-240	50
○ 11 ⑥	264-241	100
○ 12 ⑥ ③	264-242	25



Ex e II terminal strip; with mounting flanges; for screw or similar mounting types; 3.2 mm mounting hole diameter



Ex e II terminal strip; with snap-in mounting feet; for 0.6 ... 1.2 mm plate thickness; 3.5 mm mounting hole diameter

4-conductor Ex e II terminal strip; with snap-in mounting feet; for 0.6 ... 1.2 mm plate thickness; 3.5 mm mounting hole diameter; light gray

○ 2 ⑥	264-282	100
○ 3 ⑥	264-283	100
○ 4 ⑥	264-284	100
○ 5 ⑥	264-285	100
○ 6 ⑥	264-286	100
○ 7 ⑥	264-287	50
○ 8 ⑥	264-288	50
○ 9 ⑥	264-289	50
○ 10 ⑥	264-290	25
○ 11 ⑥	264-291	25
○ 12 ⑥ ③	264-292	25

Modular Terminal Blocks and Terminal Strips

260 to 262 Series

Description and Installation

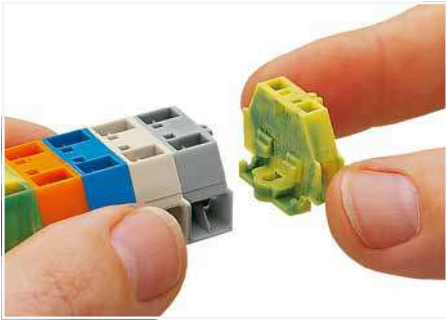

Assembling modular terminal blocks into terminal strips.



Mounting an end plate.

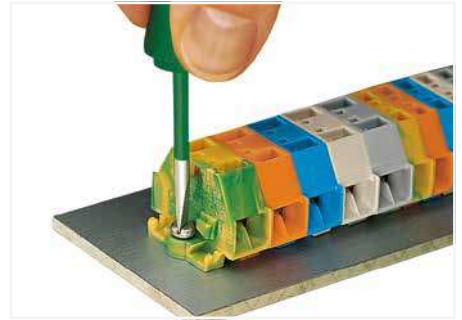

Mounting and securing a terminal strip directly to the plate via screw-type flanges.



CAGE CLAMP® termination:
Inserting a conductor.
With ferruled conductors, it is necessary to use a terminal block one size smaller than the conductor's nominal cross section.

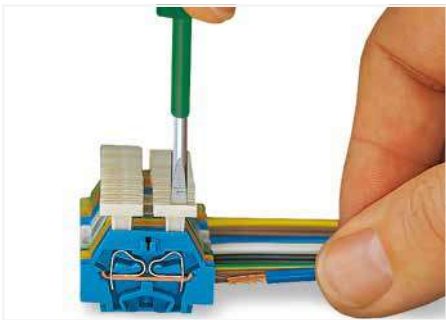

CAGE CLAMP® termination:
Inserting a conductor via push-button.



9

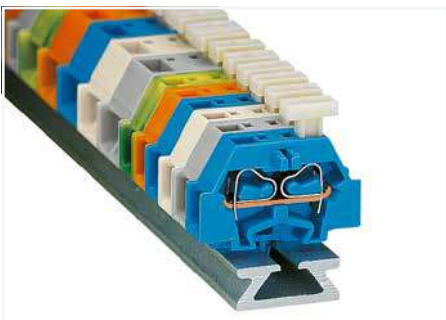

Terminal strip; with push-buttons on one side

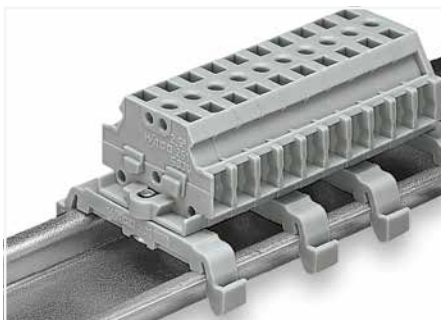

Terminal strip; with marker slot for Mini-WSB Quick Marking System

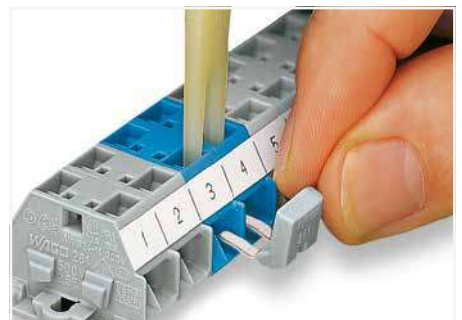

Commoning with comb-style jumper bar.



CAGE CLAMP® terminates the following copper conductors:
solid "s"



stranded "st"



fine-stranded "f-st", also with tinned single strands



Mounting a terminal strip with snap-in feet into holes.



Mounting a terminal strip with snap-in feet onto the aluminum rail.



Mounting and securing a terminal strip directly to the plate via screw-type flanges. screwing a mounting foot (209-123) (distance between mounting feet: approx. 20 ... 25 mm)

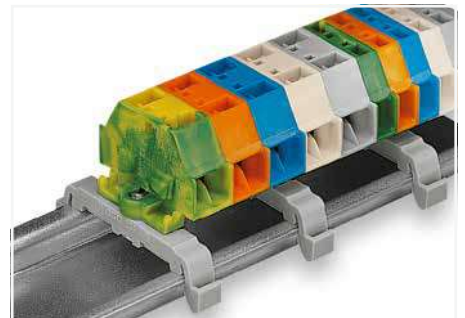
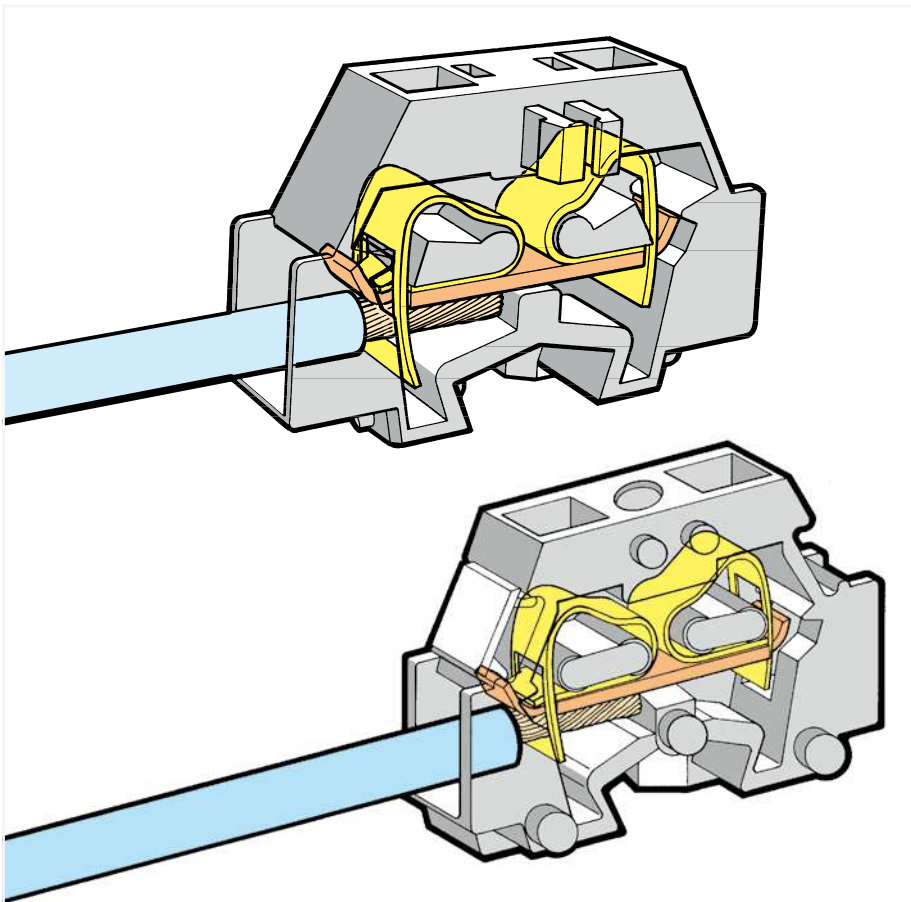

Terminal strip; with mounting flanges; for DIN-35 rail

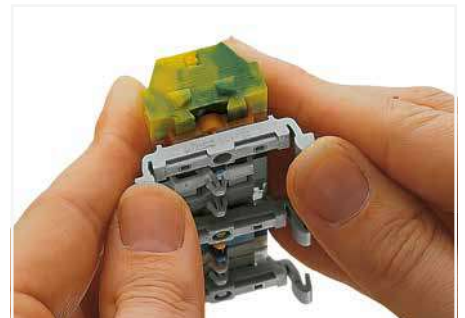

Terminal strip; with snap-in mounting feet; snapping a mounting foot (209-120) (distance between mounting feet: approx. 20 ... 25 mm)

9



Marking with self-adhesive marking strips.



Marking by direct printing (upon request).

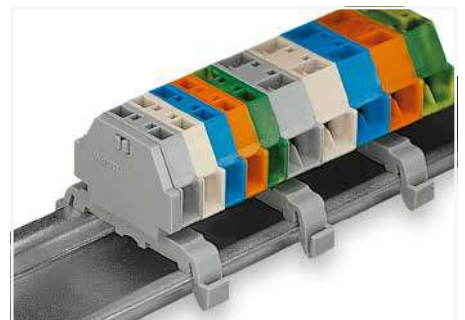

Terminal strip; with snap-in mounting feet; for DIN-35 rail



fine-stranded, tip-bonded



fine-stranded, with ferrule (gastight crimped)



fine-stranded, with pin terminal (gastight crimped)



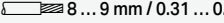

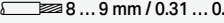
Modular Terminal Block; with Mounting Flange or Snap-In Mounting Foot 1.5 mm²; 260 Series

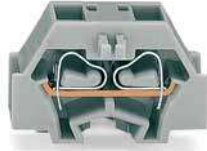
Technical Data	
0.08 ... 1.5 mm ² (28 ... 16 AWG)	28 ... 16 AWG
400 V / 6 kV / 3 ①	300 V, 10 A ②
I _N 18 A	300 V, 15 A ③
Terminal block width: 5 mm / 0.197 inch	
 8 ... 9 mm / 0.31 ... 0.35 inch	





Technical Data	
0.08 ... 1.5 mm ² (28 ... 16 AWG)	28 ... 16 AWG
400 V / 6 kV / 3 ①	300 V, 10 A ②
I _N 18 A	300 V, 15 A ③
Terminal block width: 8 mm / 0.315 inch	
 8 ... 9 mm / 0.31 ... 0.35 inch	







2-conductor terminal block; with mounting flange; for screw or similar mounting types; 3.2 mm mounting hole diameter; with mounting foot (209-123) also for DIN-35 rail

Color	Item No.	Pack. Unit
 gray	260-301	300 (50)
 light gray	260-303	300 (50)
 blue	260-304	300 (50)
 orange	260-306	300 (50)
 green-yellow	260-307	300 (50)





4-conductor terminal block; with mounting flange; for screw or similar mounting types; 3.2 mm mounting hole diameter; with mounting foot (209-123) also for DIN-35 rail

Color	Item No.	Pack. Unit
 gray	260-331	300 (50)
 light gray	260-333	300 (50)
 blue	260-334	300 (50)
 orange	260-336	300 (50)
 green-yellow	260-337	300 (50)





2-conductor terminal block; with snap-in mounting foot; for 0.6 ... 1.2 mm plate thickness; 3.5 mm mounting hole diameter; also for aluminum rail (210-154) or with mounting foot (209-120) for DIN-35 rail

Color	Item No.	Pack. Unit
 gray	260-311	300 (50)
 light gray	260-313	300 (50)
 blue	260-314	300 (50)
 orange	260-316	300 (50)
 green-yellow	260-317	300 (50)





4-conductor terminal block; with snap-in mounting foot; for 0.6 ... 1.2 mm plate thickness; 3.5 mm mounting hole diameter; also for aluminum rail (210-154) or with mounting foot (209-120) for DIN-35 rail

Color	Item No.	Pack. Unit
 gray	260-341	300 (50)
 light gray	260-343	300 (50)
 blue	260-344	300 (50)
 orange	260-346	300 (50)
 green-yellow	260-347	300 (50)

Space-saving 2-conductor end terminal block; without protruding snap-in mounting foot; for terminal strips with snap-in mounting feet

Color	Item No.	Pack. Unit
 gray	260-321	300 (50)
 light gray	260-323	300 (50)
 blue	260-324	300 (50)
 orange	260-326	300 (50)
 green-yellow	260-327	300 (50)

Space-saving 4-conductor end terminal block; without protruding snap-in mounting foot; for terminal strips with snap-in mounting feet

Color	Item No.	Pack. Unit
 gray	260-351	300 (50)
 light gray	260-353	300 (50)
 blue	260-354	300 (50)
 orange	260-356	300 (50)
 green-yellow	260-357	300 (50)

Accessories; item-specific

Test plug module; snaps together; 5 mm wide

 gray	249-135	100 (25)
--	---------	----------

Accessories; item-specific

Test plug module; snaps together; 8 mm wide

 gray	249-138	100 (25)
--	---------	----------

Test plug module; with locking latches; snaps together; 5 mm wide

 gray	260-404	100 (25)
--	---------	----------

Test plug module; with locking latches; snaps together; 8 mm wide

 gray	260-405	100 (25)
--	---------	----------

Accessories; 260 Series
Marking accessories, see Section 14

End plate; with mounting flange

 gray	260-361	300 (50)
--	---------	----------

Comb-style jumper bar; insulated; reduces maximum conductor size to 1 mm²; I_N 10 A; gray

 2-way	260-402	25
---	---------	----

End plate; with snap-in mounting foot

 gray	260-371	300 (50)
--	---------	----------

Operating tool; insulated; for comb-style jumper bar

 2-way	209-132	1
---	---------	---

① 400 V = rated voltage
6 kV = rated impulse voltage
3 = pollution degree
(see Section 15)

See application notes for:
Test plug module, page 420

Approvals and corresponding ratings,
visit www.wago.com

Accessories; 260 Series
Marking accessories, see Section 14

Test plug; with 500 mm cable; 2 mm Ø; max. 42 V

 red	210-136	50
---	---------	----

Aluminum mounting rail; 1000 mm long; 18 mm wide; 7 mm high

 210-154	1
---	---

Plastic end stop; with WSB marker slot; for aluminum rail (210-154); 6 mm wide

 209-122	25
---	----

Mounting foot; for DIN-35 rail; snaps onto terminal blocks with snap-in mounting foot; 6.4 mm wide

 gray	209-120	25
--	---------	----

Mounting screw; for mounting foot (209-120)

209-119	500 (50)
---------	----------

Mounting foot with screw; for DIN-35 rail; can be screwed on terminal blocks with mounting flange; 6.4 mm wide

 gray	209-123	25
--	---------	----

Mounting adapter; for DIN-35 rail; can be used as end plate; 6.5 mm wide

 gray	209-137	25
--	---------	----

Operating tool with a partially insulated shaft; Type 2; (3.5 x 0.5) mm blade

 210-720	1
---	---

Terminal Strip; with Mounting Flanges or Snap-in Mounting Feet 1.5 mm²; 260 Series

Technical Data	
0.08 ... 1.5 mm² (28 ... 16 AWG)	28 ... 16 AWG
400 V / 6 kV / 3 ❶	300 V, 10 A ❷
I _N 18 A	300 V, 15 A ❸
Pole width: 5 mm / 0.197 inch	
8 ... 9 mm / 0.31 ... 0.35 inch	

Technical Data	
0.08 ... 1.5 mm² (28 ... 16 AWG)	28 ... 16 AWG
400 V / 6 kV / 3 ❶	300 V, 10 A ❷
I _N 18 A	300 V, 15 A ❸
Pole width: 8 mm / 0.315 inch	
8 ... 9 mm / 0.31 ... 0.35 inch	

- ❶ 400 V = rated voltage
6 kV = rated impulse voltage
3 = pollution degree
(see Section 15)
 - ❷ Longer strips and/or mixed-color assemblies are available upon request.
- Approvals and corresponding ratings, visit www.wago.com

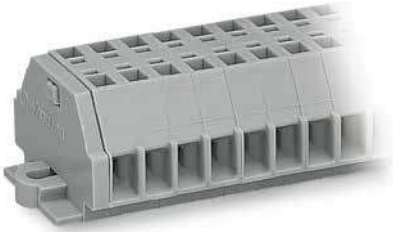

Dimensions in mm

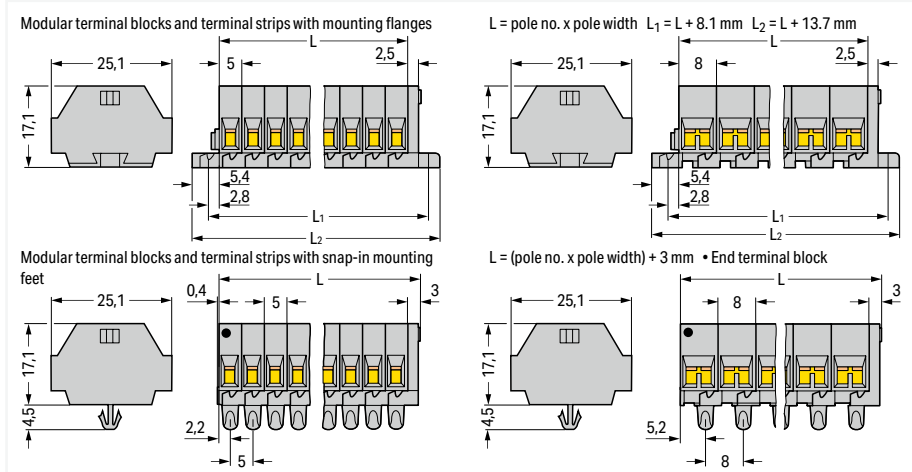

Terminal strip; with mounting flanges; for screw or similar mounting types; 3.2 mm mounting hole diameter (with 209-123 Mounting Foot for DIN-35 rail)



Terminal strip; with snap-in mounting feet; for 0.6 ... 1.2 mm plate thickness; 3.5 mm mounting hole diameter (also for 210-154 Aluminum Rail or with 209-120 Mounting Foot for DIN-35 rail)

2-conductor terminal strip; with mounting flanges; for screw or similar mounting types; 3.2 mm mounting hole diameter; with mounting foot (209-123) also for DIN-35 rail; gray

4-conductor terminal strip; with mounting flanges; for screw or similar mounting types; 3.2 mm mounting hole diameter; with mounting foot (209-123) also for DIN-35 rail; gray

Pole No.	Item No.	Pack. Unit
2	260-102	100
3	260-103	100
4	260-104	100
5	260-105	100
6	260-106	100
7	260-107	100
8	260-108	100
9	260-109	50
10	260-110	50
11	260-111	50
12 ❷	260-112	25

Pole No.	Item No.	Pack. Unit
2	260-202	100
3	260-203	100
4	260-204	100
5	260-205	100
6	260-206	100
7	260-207	100
8	260-208	100
9	260-209	50
10	260-210	50
11	260-211	25
12 ❷	260-212	25

2-conductor terminal strip; with snap-in mounting feet; for 0.6 ... 1.2 mm plate thickness; 3.5 mm mounting hole diameter; also for aluminum rail (210-154) or with mounting foot (209-120) for DIN-35 rail; gray

4-conductor terminal strip; with snap-in mounting feet; for 0.6 ... 1.2 mm plate thickness; 3.5 mm mounting hole diameter; also for aluminum rail (210-154) or with mounting foot (209-120) for DIN-35 rail; gray

Pole No.	Item No.	Pack. Unit
2	260-152	100
3	260-153	100
4	260-154	100
5	260-155	100
6	260-156	50
7	260-157	50
8	260-158	50
9	260-159	50
10	260-160	25
11	260-161	25
12 ❷	260-162	25

Pole No.	Item No.	Pack. Unit
2	260-252	100
3	260-253	100
4	260-254	100
5	260-255	100
6	260-256	50
7	260-257	50
8	260-258	50
9	260-259	50
10	260-260	25
11	260-261	25
12 ❷	260-262	25

Modular Terminal Block; with Mounting Flange or Snap-In Mounting Foot 2.5 mm²; 261 Series

Technical Data

0.08 ... 2.5 mm ²	28 ... 14 AWG
500 V / 6 kV / 3 ①	300 V, 15 A
I _N 24 A	300 V, 20 A
Terminal block width: 6 mm / 0.236 inch	
8 ... 9 mm / 0.31 ... 0.35 inch	

Technical Data

0.08 ... 2.5 mm ²	28 ... 14 AWG
500 V / 6 kV / 3 ①	300 V, 15 A
I _N 24 A	300 V, 20 A
Terminal block width: 10 mm / 0.394 inch	
8 ... 9 mm / 0.31 ... 0.35 inch	



2-conductor terminal block; with mounting flange; for screw or similar mounting types; 3.2 mm mounting hole diameter; with mounting foot (209-123) also for DIN-35 rail

Color	Item No.	Pack. Unit
	261-301	200 (50)
	261-303	200 (50)
	261-304 ②	200 (50)
	261-306	200 (50)
	261-307	200 (50)

4-conductor terminal block; with mounting flange; for screw or similar mounting types; 3.2 mm mounting hole diameter; with mounting foot (209-123) also for DIN-35 rail

Color	Item No.	Pack. Unit
	261-331	200 (50)
	261-333	200 (50)
	261-334 ②	200 (50)
	261-336	200 (50)
	261-337	200 (50)

2-conductor terminal block; with snap-in mounting foot; for 0.6 ... 1.2 mm plate thickness; 3.5 mm mounting hole diameter; also for aluminum rail (210-154) or with mounting foot (209-120) for DIN-35 rail

	261-311	200 (50)
	261-313	200 (50)
	261-314 ②	200 (50)
	261-316	200 (50)
	261-317	200 (50)

4-conductor terminal block; with snap-in mounting foot; for 0.6 ... 1.2 mm plate thickness; 3.5 mm mounting hole diameter; also for aluminum rail (210-154) or with mounting foot (209-120) for DIN-35 rail

	261-341	200 (50)
	261-343	200 (50)
	261-344 ②	200 (50)
	261-346	200 (50)
	261-347	200 (50)

Space-saving 2-conductor end terminal block; without protruding snap-in mounting foot; for terminal strips with snap-in mounting feet

	261-321	200 (50)
	261-323	200 (50)
	261-324 ②	200 (50)
	261-326	200 (50)
	261-327	200 (50)

Space-saving 4-conductor end terminal block; without protruding snap-in mounting foot; for terminal strips with snap-in mounting feet

	261-351	200 (50)
	261-353	200 (50)
	261-354 ②	200 (50)
	261-356	200 (50)
	261-357	200 (50)

Accessories; item-specific

Test plug module; snaps together; 6 mm wide

	gray	249-136	100 (25)
--	------	---------	----------

Test plug module; with locking latches; snaps together; 6 mm wide

	gray	261-404	100 (25)
--	------	---------	----------

Accessories; item-specific

Test plug module; snaps together; 10 mm wide

	gray	249-139	100 (25)
--	------	---------	----------

Test plug module; with locking latches; snaps together; 10 mm wide

	gray	261-405	100 (25)
--	------	---------	----------

Accessories; 261 Series

Marking accessories, see Section 14

End plate; with mounting flange

	gray	261-361	300 (50)
--	------	---------	----------

End plate; with snap-in mounting foot

	gray	261-371	300 (50)
--	------	---------	----------

Comb-style jumper bar; insulated; reduces maximum conductor size to 1.5 mm²; I_N 16 A; gray

	2-way	261-402	25
--	-------	---------	----

Operating tool; insulated; for comb-style jumper bar

	2-way	209-132	1
--	-------	---------	---

① 500 V = rated voltage
6 kV = rated impulse voltage
3 = pollution degree
(see Section 15)

② Terminal blocks with a blue insulated housing are suitable for Ex i applications.

See application notes for:
Test plug module, page 420

Approvals and corresponding ratings,
visit www.wago.com

Accessories; 261 Series

Marking accessories, see Section 14

Test plug; with 500 mm cable; 2 mm Ø; max. 42 V

	red	210-136	50
--	-----	---------	----

Aluminum mounting rail; 1000 mm long; 18 mm wide; 7 mm high

		210-154	1
--	--	---------	---

Plastic end stop; with WSB marker slot; for aluminum rail (210-154); 6 mm wide

		209-122	25
--	--	---------	----

Mounting foot; for DIN-35 rail; snaps onto terminal blocks with snap-in mounting foot; 6.4 mm wide

	gray	209-120	25
--	------	---------	----

Mounting screw; for mounting foot (209-120)

		209-119	500 (50)
--	--	---------	----------

Mounting foot with screw; for DIN-35 rail; can be screwed on terminal blocks with mounting flange; 6.4 mm wide

	gray	209-123	25
--	------	---------	----

Mounting adapter; for DIN-35 rail; can be used as end plate; 6.5 mm wide

	gray	209-137	25
--	------	---------	----

Operating tool with a partially insulated shaft; Type 2; (3.5 x 0.5) mm blade

		210-720	1
--	--	---------	---

Terminal Strip; with Mounting Flanges or Snap-in Mounting Feet 2.5 mm²; 261 Series

Technical Data

0.08 ... 2.5 mm ²	28 ... 14 AWG
500 V / 6 kV / 3 ❶	300 V, 15 A ❷
I _N 24 A	300 V, 20 A ❸

Pole width: 6 mm / 0.236 inch

8 ... 9 mm / 0.31 ... 0.35 inch

Technical Data

0.08 ... 2.5 mm ²	28 ... 14 AWG
500 V / 6 kV / 3 ❶	300 V, 15 A ❷
I _N 24 A	300 V, 20 A ❸

Pole width: 10 mm / 0.394 inch

8 ... 9 mm / 0.31 ... 0.35 inch

- ❶ 500 V = rated voltage
6 kV = rated impulse voltage
3 = pollution degree
(see Section 15)
- ❷ Terminal strips with a blue insulated housing are suitable for Ex i applications.
Item no. suffixes .../000-006 (upon request)
- ❸ Longer strips and/or mixed-color assemblies are available upon request.

Approvals and corresponding ratings, visit www.wago.com

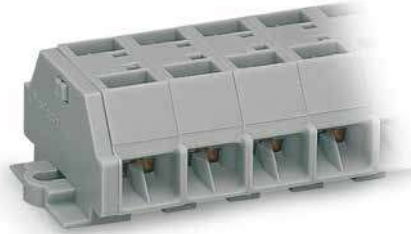
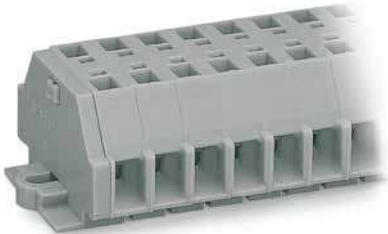

Dimensions in mm

Modular terminal blocks and terminal strips with mounting flanges

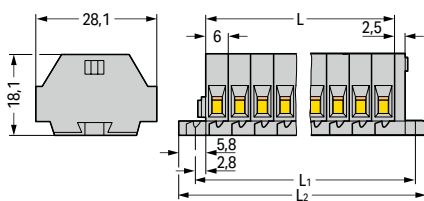

$L = \text{pole no.} \times \text{pole width}$ $L_1 = L + 8.1 \text{ mm}$ $L_2 = L + 14.1 \text{ mm}$

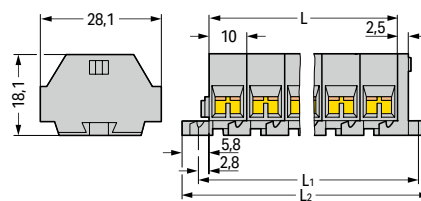

Modular terminal blocks and terminal strips with snap-in mounting feet

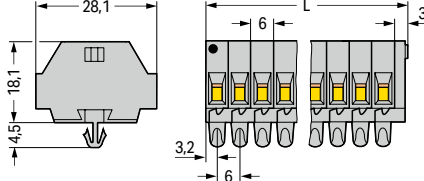

$L = (\text{pole no.} \times \text{pole width}) + 3 \text{ mm}$ • End terminal block

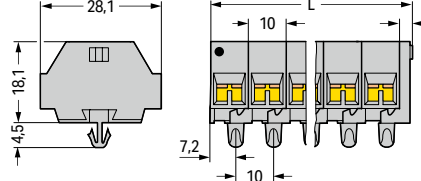

2-conductor terminal strip; with mounting flanges; for screw or similar mounting types; 3.2 mm mounting hole diameter; with mounting foot (209-123) also for DIN-35 rail; gray ❷

Pole No.	Item No.	Pack. Unit
○ 2	261-102	100
○ 3	261-103	100
○ 4	261-104	100
○ 5	261-105	200
○ 6	261-106	50
○ 7	261-107	50
○ 8	261-108	50
○ 9	261-109	50
○ 10	261-110	25
○ 11	261-111	25
○ 12 ❸	261-112	25

4-conductor terminal strip; with mounting flanges; for screw or similar mounting types; 3.2 mm mounting hole diameter; with mounting foot (209-123) also for DIN-35 rail; gray ❷

Pole No.	Item No.	Pack. Unit
○ 2	261-202	100
○ 3	261-203	100
○ 4	261-204	100
○ 5	261-205	100
○ 6	261-206	50
○ 7	261-207	50
○ 8	261-208	50
○ 9	261-209	50
○ 10	261-210	25
○ 11	261-211	25
○ 12 ❸	261-212	25

2-conductor terminal strip; with snap-in mounting feet; for 0.6 ... 1.2 mm plate thickness; 3.5 mm mounting hole diameter; also for aluminum rail (210-154) or with mounting foot (209-120) for DIN-35 rail; gray ❷

○ 2	261-152	100
○ 3	261-153	100
○ 4	261-154	100
○ 5	261-155	100
○ 6	261-156	50
○ 7	261-157	50
○ 8	261-158	50
○ 9	261-159	50
○ 10	261-160	25
○ 11	261-161	25
○ 12 ❸	261-162	25

4-conductor terminal strip; with snap-in mounting feet; for 0.6 ... 1.2 mm plate thickness; 3.5 mm mounting hole diameter; also for aluminum rail (210-154) or with mounting foot (209-120) for DIN-35 rail; gray ❷

○ 2	261-252	100
○ 3	261-253	100
○ 4	261-254	100
○ 5	261-255	100
○ 6	261-256	50
○ 7	261-257	50
○ 8	261-258	50
○ 9	261-259	50
○ 10	261-260	25
○ 11	261-261	25
○ 12 ❸	261-262	25



Terminal strip; with mounting flanges; for screw or similar mounting types; 3.2 mm mounting hole diameter (with 209-123 Mounting Foot for DIN-35 rail)



Terminal strip; with snap-in mounting feet; for 0.6 ... 1.2 mm plate thickness; 3.5 mm mounting hole diameter (also for 210-154 Aluminum Rail or with 209-120 Mounting Foot for DIN-35 rail)

9

Modular Terminal Block; with Push-Buttons on One Side; with Mounting Flange or Snap-In Mounting Foot

2.5 mm²; 261 Series

Technical Data

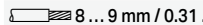
0.08 ... 2.5 mm ²	28 ... 14 AWG
500 V / 6 kV / 3 ①	300 V, 15 A ②
I _N 24 A	300 V, 20 A ②
Terminal block width: 6 mm / 0.236 inch	
 8 ... 9 mm / 0.31 ... 0.35 inch	

Technical Data

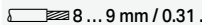
0.08 ... 2.5 mm ²	28 ... 14 AWG
500 V / 6 kV / 3 ①	300 V, 15 A ②
I _N 24 A	300 V, 20 A ②
Terminal block width: 10 mm / 0.394 inch	
 8 ... 9 mm / 0.31 ... 0.35 inch	







2-conductor terminal block; with push-button on one side; with mounting flange; for screw or similar mounting types; 3.2 mm mounting hole diameter; with mounting foot (209-123) also for DIN-35 rail

Color	Item No.	Pack. Unit
 gray	261-301/331-000	200 (50)
 light gray	261-303/331-000	200 (50)
 blue	261-304/331-000 ②	200 (50)
 orange	261-306/331-000	200 (50)
 green-yellow	261-307/331-000	200 (50)





4-conductor terminal block; with push-button on one side; with mounting flange; for screw or similar mounting types; 3.2 mm mounting hole diameter; with mounting foot (209-123) also for DIN-35 rail

Color	Item No.	Pack. Unit
 gray	261-331/332-000	200 (50)
 light gray	261-333/332-000	200 (50)
 blue	261-334/332-000 ②	200 (50)
 orange	261-336/332-000	200 (50)
 green-yellow	261-337/332-000	200 (50)





2-conductor terminal block; with push-button on one side; with snap-in mounting foot; for 0.6 ... 1.2 mm plate thickness; 3.5 mm mounting hole diameter; also for aluminum rail (210-154) or with mounting foot (209-120) for DIN-35 rail

Color	Item No.	Pack. Unit
 gray	261-311/331-000	200 (50)
 light gray	261-313/331-000	200 (50)
 blue	261-314/331-000 ②	200 (50)
 orange	261-316/331-000	200 (50)
 green-yellow	261-317/331-000	200 (50)





4-conductor terminal block; with push-button on one side; with snap-in mounting foot; for 0.6 ... 1.2 mm plate thickness; 3.5 mm mounting hole diameter; also for aluminum rail (210-154) or with mounting foot (209-120) for DIN-35 rail

Color	Item No.	Pack. Unit
 gray	261-341/332-000	200 (50)
 light gray	261-343/332-000	200 (50)
 blue	261-344/332-000 ②	200 (50)
 orange	261-346/332-000	200 (50)
 green-yellow	261-347/332-000	200 (50)

Space-saving 2-conductor end terminal block; with push-button on one side; without protruding snap-in mounting foot; for terminal strips with snap-in mounting feet

Color	Item No.	Pack. Unit
 gray	261-321/331-000	200 (50)
 light gray	261-323/331-000	200 (50)
 blue	261-324/331-000 ②	200 (50)
 orange	261-326/331-000	200 (50)
 green-yellow	261-327/331-000	200 (50)

Space-saving 4-conductor end terminal block; with push-button on one side; without protruding snap-in mounting foot; for terminal strips with snap-in mounting feet

Color	Item No.	Pack. Unit
 gray	261-351/332-000	200 (50)
 light gray	261-353/332-000	200 (50)
 blue	261-354/332-000 ②	200 (50)
 orange	261-356/332-000	200 (50)
 green-yellow	261-357/332-000	200 (50)

Accessories; 261 Series

Marking accessories, see Section 14

End plate; with mounting flange

Color	Item No.	Pack. Unit
 gray	261-361	300 (50)

End plate; with snap-in mounting foot

Color	Item No.	Pack. Unit
 gray	261-371	300 (50)

Comb-style jumper bar; insulated; reduces maximum conductor size to 1.5 mm²; I_N 16 A; gray

Configuration	Item No.	Pack. Unit
2-way	261-402	25

Operating tool; insulated; for comb-style jumper bar

Configuration	Item No.	Pack. Unit
2-way	209-132	1

Test plug; with 500 mm cable; 2 mm Ø; max. 42 V

Color	Item No.	Pack. Unit
 red	210-136	50

Aluminum mounting rail; 1000 mm long; 18 mm wide; 7 mm high

Item No.	Pack. Unit
210-154	1

Plastic end stop; with WSB marker slot; for aluminum rail (210-154); 6 mm wide

Item No.	Pack. Unit
209-122	25

- ① 500 V = rated voltage
6 kV = rated impulse voltage
3 = pollution degree
(see Section 15)

- ② Terminal blocks with a blue insulated housing are suitable for Ex i applications.

Approvals and corresponding ratings, visit www.wago.com

Accessories; 261 Series

Marking accessories, see Section 14

Mounting foot; for DIN-35 rail; snaps onto terminal blocks with snap-in mounting foot; 6.4 mm wide

Color	Item No.	Pack. Unit
 gray	209-120	25

Mounting screw; for mounting foot (209-120)

Item No.	Pack. Unit
209-119	500 (50)

Mounting foot with screw; for DIN-35 rail; can be screwed on terminal blocks with mounting flange; 6.4 mm wide

Color	Item No.	Pack. Unit
 gray	209-123	25

Mounting adapter; for DIN-35 rail; can be used as end plate; 6.5 mm wide

Color	Item No.	Pack. Unit
 gray	209-137	25

Operating tool with a partially insulated shaft; Type 2; (3.5 x 0.5) mm blade

Item No.	Pack. Unit
210-720	1

Terminal Strip; with Push-Buttons on One Side; with Mounting Flanges or Snap-in Mounting Feet 2.5 mm²; 261 Series

Technical Data	
0.08 ... 2.5 mm ²	28 ... 14 AWG
500 V / 6 kV / 3 ①	
I _N 24 A	
Pole width: 6 mm / 0.236 inch	
 8 ... 9 mm / 0.31 ... 0.35 inch	

Technical Data	
0.08 ... 2.5 mm ²	28 ... 14 AWG
500 V / 6 kV / 3 ①	
I _N 24 A	
Pole width: 10 mm / 0.394 inch	
 8 ... 9 mm / 0.31 ... 0.35 inch	

- ① 500 V = rated voltage
6 kV = rated impulse voltage
3 = pollution degree
(see Section 15)
 - ② Terminal strips with a blue insulated housing are suitable for Ex i applications.
Item no. suffixes .../000-006 (upon request)
 - ③ Longer strips and/or mixed-color assemblies are available upon request.
- Approvals and corresponding ratings, visit www.wago.com

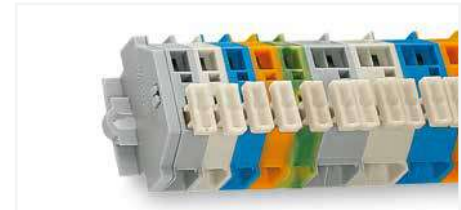
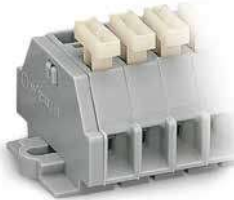

Dimensions in mm

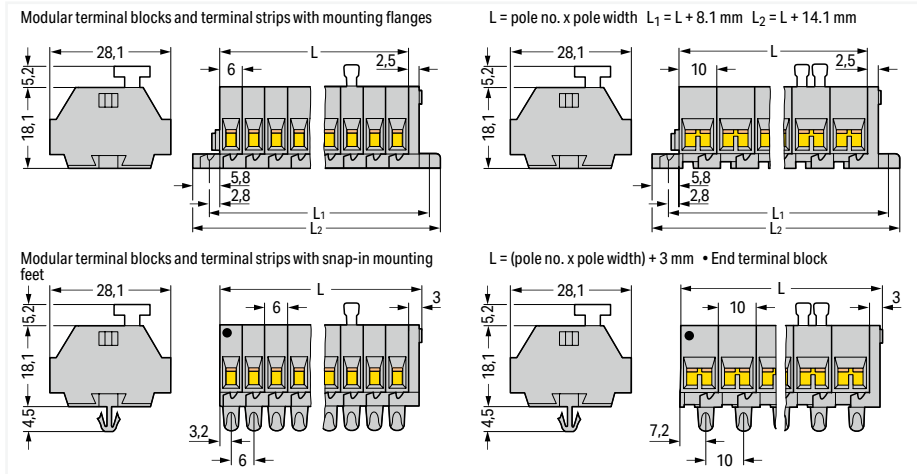

Terminal strip; with mounting flanges; for screw or similar mounting types; 3.2 mm mounting hole diameter (with 209-123 Mounting Foot for DIN-35 rail)



Terminal strip; with snap-in mounting feet; for 0.6 ... 1.2 mm plate thickness; 3.5 mm mounting hole diameter (also for 210-154 Aluminum Rail or with 209-120 Mounting Foot for DIN-35 rail)

2-conductor terminal strip; with push-buttons on one side; with mounting flanges; for screw or similar mounting types; 3.2 mm mounting hole diameter; with mounting foot (209-123) also for DIN-35 rail; gray ②

Pole No.	Item No.	Pack. Unit
○ 2	261-102/331-000	100
○ 3	261-103/331-000	100
○ 4	261-104/331-000	100
○ 5	261-105/331-000	200
○ 6	261-106/331-000	50
○ 7	261-107/331-000	50
○ 8	261-108/331-000	50
○ 9	261-109/331-000	50
○ 10	261-110/331-000	25
○ 11	261-111/331-000	25
○ 12 ③	261-112/331-000	25

4-conductor terminal strip; with push-buttons on one side; with mounting flanges; for screw or similar mounting types; 3.2 mm mounting hole diameter; with mounting foot (209-123) also for DIN-35 rail; gray ②

Pole No.	Item No.	Pack. Unit
○ 2	261-202/332-000	100
○ 3	261-203/332-000	100
○ 4	261-204/332-000	100
○ 5	261-205/332-000	100
○ 6	261-206/332-000	50
○ 7	261-207/332-000	50
○ 8	261-208/332-000	50
○ 9	261-209/332-000	50
○ 10	261-210/332-000	50
○ 11	261-211/332-000	25
○ 12 ③	261-212/332-000	50

2-conductor terminal strip; with push-buttons on one side; with snap-in mounting feet; for 0.6 ... 1.2 mm plate thickness; 3.5 mm mounting hole diameter; also for aluminum rail (210-154) or with mounting foot (209-120) for DIN-35 rail; gray ②

Pole No.	Item No.	Pack. Unit
○ 2	261-152/331-000	100
○ 3	261-153/331-000	100
○ 4	261-154/331-000	100
○ 5	261-155/331-000	100
○ 6	261-156/331-000	50
○ 7	261-157/331-000	50
○ 8	261-158/331-000	50
○ 9	261-159/331-000	50
○ 10	261-160/331-000	25
○ 11	261-161/331-000	25
○ 12 ③	261-162/331-000	25

4-conductor terminal strip; with push-buttons on one side; with snap-in mounting feet; for 0.6 ... 1.2 mm plate thickness; 3.5 mm mounting hole diameter; also for aluminum rail (210-154) or with mounting foot (209-120) for DIN-35 rail; gray ②

Pole No.	Item No.	Pack. Unit
○ 2	261-252/332-000	100
○ 3	261-253/332-000	100
○ 4	261-254/332-000	100
○ 5	261-255/332-000	100
○ 6	261-256/332-000	50
○ 7	261-257/332-000	50
○ 8	261-258/332-000	50
○ 9	261-259/332-000	50
○ 10	261-260/332-000	25
○ 11	261-261/332-000	100
○ 12 ③	261-262/332-000	25

Modular Terminal Block; with Push-Buttons on Both Sides; with Mounting Flange or Snap-In Mounting Foot

2.5 mm²; 261 Series

Technical Data	
0.08 ... 2.5 mm ²	28 ... 14 AWG
500 V / 6 kV / 3 ①	300 V, 15 A
I _N 24 A	300 V, 20 A
Terminal block width: 6 mm / 0.236 inch	
8 ... 9 mm / 0.31 ... 0.35 inch	

Technical Data	
0.08 ... 2.5 mm ²	28 ... 14 AWG
500 V / 6 kV / 3 ①	300 V, 15 A
I _N 24 A	300 V, 20 A
Terminal block width: 10 mm / 0.394 inch	
8 ... 9 mm / 0.31 ... 0.35 inch	



2-conductor terminal block; with push-buttons on both sides; with mounting flange; for screw or similar mounting types; 3.2 mm mounting hole diameter; with mounting foot (209-123) also for DIN-35 rail

Color	Item No.	Pack. Unit
gray	261-301/341-000	200 (50)
light gray	261-303/341-000	200 (50)
blue	261-304/341-000 ②	200 (50)
orange	261-306/341-000	200 (50)
green-yellow	261-307/341-000	200 (50)

4-conductor terminal block; with push-buttons on both sides; with mounting flange; for screw or similar mounting types; 3.2 mm mounting hole diameter; with mounting foot (209-123) also for DIN-35 rail

Color	Item No.	Pack. Unit
gray	261-331/342-000	200 (50)
light gray	261-333/342-000	200 (50)
blue	261-334/342-000 ②	200 (50)
orange	261-336/342-000	200 (50)
green-yellow	261-337/342-000	200 (50)

2-conductor terminal block; with push-buttons on both sides; with snap-in mounting foot; for 0.6 ... 1.2 mm plate thickness; 3.5 mm mounting hole diameter; also for aluminum rail (210-154) or with mounting foot (209-120) for DIN-35 rail

Color	Item No.	Pack. Unit
gray	261-311/341-000	200 (50)
light gray	261-313/341-000	200 (50)
blue	261-314/341-000 ②	200 (50)
orange	261-316/341-000	200 (50)
green-yellow	261-317/341-000	200 (50)

4-conductor terminal block; with push-buttons on both sides; with snap-in mounting foot; for 0.6 ... 1.2 mm plate thickness; 3.5 mm mounting hole diameter; also for aluminum rail (210-154) or with mounting foot (209-120) for DIN-35 rail

Color	Item No.	Pack. Unit
gray	261-341/342-000	200 (50)
light gray	261-343/342-000	200 (50)
blue	261-344/342-000 ②	200 (50)
orange	261-346/342-000	200 (50)
green-yellow	261-347/342-000	200 (50)

Space-saving 2-conductor end terminal block; with push-buttons on both sides; without protruding snap-in mounting foot; for terminal strips with snap-in mounting feet

Color	Item No.	Pack. Unit
gray	261-321/341-000	200 (50)
light gray	261-323/341-000	200 (50)
blue	261-324/341-000 ②	200 (50)
orange	261-326/341-000	200 (50)
green-yellow	261-327/341-000	200 (50)

Space-saving 4-conductor end terminal block; with push-buttons on both sides; without protruding snap-in mounting foot; for terminal strips with snap-in mounting feet

Color	Item No.	Pack. Unit
gray	261-351/342-000	200 (50)
light gray	261-353/342-000	200 (50)
blue	261-354/342-000 ②	200 (50)
orange	261-356/342-000	200 (50)
green-yellow	261-357/342-000	200 (50)

Accessories; 261 Series

Marking accessories, see Section 14

End plate; with mounting flange

gray	261-361	300 (50)
------	---------	----------

End plate; with snap-in mounting foot

gray	261-371	300 (50)
------	---------	----------

Comb-style jumper bar; insulated; reduces maximum conductor size to 1.5 mm²; I_N 16 A; gray

2-way	261-402	25
-------	---------	----

Operating tool; insulated; for comb-style jumper bar

2-way	209-132	1
-------	---------	---

Test plug; with 500 mm cable; 2 mm Ø; max. 42 V

red	210-136	50
-----	---------	----

Aluminum mounting rail; 1000 mm long; 18 mm wide; 7 mm high

	210-154	1
--	---------	---

Plastic end stop; with WSB marker slot; for aluminum rail (210-154); 6 mm wide

	209-122	25
--	---------	----

① 500 V = rated voltage
6 kV = rated impulse voltage
3 = pollution degree
(see Section 15)

② Terminal blocks with a blue insulated housing are suitable for Ex i applications.

Approvals and corresponding ratings, visit www.wago.com

Accessories; 261 Series

Marking accessories, see Section 14

Mounting foot; for DIN-35 rail; snaps onto terminal blocks with snap-in mounting foot; 6.4 mm wide

gray	209-120	25
------	---------	----

Mounting screw; for mounting foot (209-120)

	209-119	500 (50)
--	---------	----------

Mounting foot with screw; for DIN-35 rail; can be screwed on terminal blocks with mounting flange; 6.4 mm wide

gray	209-123	25
------	---------	----

Mounting adapter; for DIN-35 rail; can be used as end plate; 6.5 mm wide

gray	209-137	25
------	---------	----

Operating tool with a partially insulated shaft; Type 2; (3.5 x 0.5) mm blade

	210-720	1
--	---------	---

9

Terminal Strip; with Push-Buttons on Both Sides; with Mounting Flanges or Snap-in Mounting Feet

2.5 mm²; 261 Series

Technical Data	
0.08 ... 2.5 mm ²	28 ... 14 AWG
500 V / 6 kV / 3 ①	
I _N 24 A	
Pole width: 6 mm / 0.236 inch	
8 ... 9 mm / 0.31 ... 0.35 inch	

Technical Data	
0.08 ... 2.5 mm ²	28 ... 14 AWG
500 V / 6 kV / 3 ①	
I _N 24 A	
Pole width: 10 mm / 0.394 inch	
8 ... 9 mm / 0.31 ... 0.35 inch	

- ① 500 V = rated voltage
6 kV = rated impulse voltage
3 = pollution degree
(see Section 15)
 - ② Terminal strips with a blue insulated housing are suitable for Ex i applications.
Item no. suffixes .../000-006 (upon request)
 - ③ Longer strips and/or mixed-color assemblies are available upon request.
- Approvals and corresponding ratings, visit www.wago.com

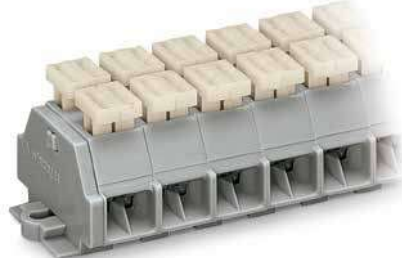
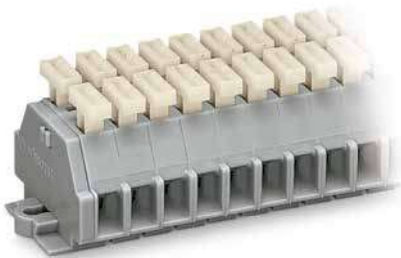

Dimensions in mm

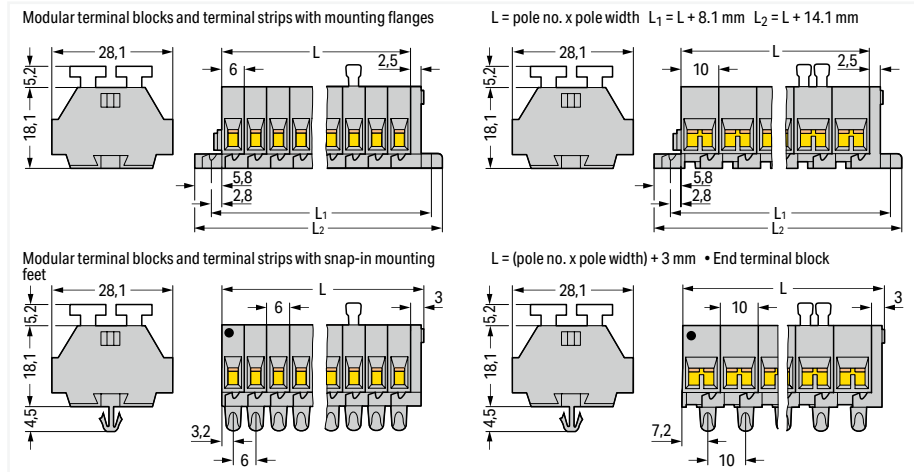

Terminal strip; with mounting flanges; for screw or similar mounting types; 3.2 mm mounting hole diameter (with 209-123 Mounting Foot for DIN-35 rail)



Terminal strip; with snap-in mounting feet; for 0.6 ... 1.2 mm plate thickness; 3.5 mm mounting hole diameter (also for 210-154 Aluminum Rail or with 209-120 Mounting Foot for DIN-35 rail)

2-conductor terminal strip; with push-buttons on both sides; with mounting flanges; for screw or similar mounting types; 3.2 mm mounting hole diameter; with mounting foot (209-123) also for DIN-35 rail; gray ②

Pole No.	Item No.	Pack. Unit
○ 2	261-102/341-000	100
○ 3	261-103/341-000	100
○ 4	261-104/341-000	50
○ 5	261-105/341-000	100
○ 6	261-106/341-000	25
○ 7	261-107/341-000	50
○ 8	261-108/341-000	50
○ 9	261-109/341-000	100
○ 10	261-110/341-000	25
○ 11	261-111/341-000	25
○ 12 ③	261-112/341-000	25

4-conductor terminal strip; with push-buttons on both sides; with mounting flanges; for screw or similar mounting types; 3.2 mm mounting hole diameter; with mounting foot (209-123) also for DIN-35 rail; gray ②

Pole No.	Item No.	Pack. Unit
○ 2	261-202/342-000	100
○ 3	261-203/342-000	100
○ 4	261-204/342-000	100
○ 5	261-205/342-000	100
○ 6	261-206/342-000	50
○ 7	261-207/342-000	50
○ 8	261-208/342-000	100
○ 9	261-209/342-000	50
○ 10	261-210/342-000	25
○ 11	261-211/342-000	25
○ 12 ③	261-212/342-000	50

2-conductor terminal strip; with push-buttons on both sides; with snap-in mounting feet; for 0.6 ... 1.2 mm plate thickness; 3.5 mm mounting hole diameter; also for aluminum rail (210-154) or with mounting foot (209-120) for DIN-35 rail; gray ②

Pole No.	Item No.	Pack. Unit
○ 2	261-152/341-000	100
○ 3	261-153/341-000	100
○ 4	261-154/341-000	50
○ 5	261-155/341-000	100
○ 6	261-156/341-000	100
○ 7	261-157/341-000	50
○ 8	261-158/341-000	50
○ 9	261-159/341-000	50
○ 10	261-160/341-000	25
○ 11	261-161/341-000	25
○ 12 ③	261-162/341-000	100

4-conductor terminal strip; with push-buttons on both sides; with snap-in mounting feet; for 0.6 ... 1.2 mm plate thickness; 3.5 mm mounting hole diameter; also for aluminum rail (210-154) or with mounting foot (209-120) for DIN-35 rail; gray ②

Pole No.	Item No.	Pack. Unit
○ 2	261-252/342-000	100
○ 3	261-253/342-000	100
○ 4	261-254/342-000	100
○ 5	261-255/342-000	100
○ 6	261-256/342-000	50
○ 7	261-257/342-000	50
○ 8	261-258/342-000	50
○ 9	261-259/342-000	50
○ 10	261-260/342-000	25
○ 11	261-261/342-000	100
○ 12 ③	261-262/342-000	25

Modular Terminal Block; with Mounting Flange; with Marker Slot for Mini-WSB Quick Marking System

2.5 mm²; 261 Series

Technical Data

0.08 ... 2.5 mm ²	28 ... 14 AWG
500 V / 6 kV / 3 ①	300 V, 15 A ②
I _N 24 A	300 V, 20 A ③
Terminal block width: 6 mm / 0.236 inch	
8 ... 9 mm / 0.31 ... 0.35 inch	



- ① 500 V = rated voltage
6 kV = rated impulse voltage
3 = pollution degree
(see Section 15)
- Approvals and corresponding ratings, visit www.wago.com

Accessories; 261 Series
Marking accessories, see Section 14

Mini-WSB marking card; white; 10 strips with 10 markers/
card; 5 mm wide markers

	plain	248-501	5
--	-------	---------	---

Operating tool with a partially insulated shaft; Type 2; (3.5 x 0.5) mm blade

		210-720	1
--	--	---------	---

2-conductor terminal block; with mounting flange; for screw or similar mounting types; 3.2 mm mounting hole diameter; with mounting foot (209-123) also for DIN-35 rail

Color	Item No.	Pack. Unit
○ gray	261-411	200 (50)

2-conductor terminal block; with push-button on one side; with mounting flange; for screw or similar mounting types; 3.2 mm mounting hole diameter; with mounting foot (209-123) also for DIN-35 rail

○ gray	261-411/331-000	200 (50)
--------	-----------------	----------

2-conductor terminal block; with push-buttons on both sides; with mounting flange; for screw or similar mounting types; 3.2 mm mounting hole diameter; with mounting foot (209-123) also for DIN-35 rail

○ gray	261-411/341-000	200 (50)
--------	-----------------	----------



CAGE CLAMP® termination:
Inserting a conductor via push-button.

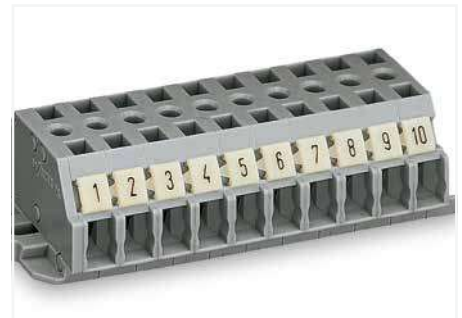

Terminal strip; with marker slot for Mini-WSB Quick Marking System

Accessories; 261 Series
Marking accessories, see Section 14

End plate; with mounting flange

	gray	261-410	300 (50)
--	------	---------	----------

Comb-style jumper bar; insulated; reduces maximum conductor size to 1 mm²; I_N 10 A; gray

	2-way	261-402	25
--	-------	---------	----

Operating tool; insulated; for comb-style jumper bar

	2-way	209-132	1
--	-------	---------	---

Test plug; with 500 mm cable; 2 mm Ø; max. 42 V

	red	210-136	50
--	-----	---------	----

Mounting foot with screw, for DIN-35 rail; can be screwed on terminal blocks with mounting flange; 6.4 mm wide

	gray	209-123	25
--	------	---------	----

Mounting adapter; for DIN-35 rail; can be used as end plate; 6.5 mm wide

	gray	209-137	25
--	------	---------	----



Testing with voltage tester.

Terminal Strip; with Mounting Flanges; with Marker Slot for Mini-WSB Quick Marking System 2.5 mm²; 261 Series

Technical Data	
0.08 ... 2.5 mm ²	28 ... 14 AWG
500 V / 6 kV / 3 ①	300 V, 15 A I_N
I_N 24 A	300 V, 20 A I_{Nc}
Pole width: 6 mm / 0.236 inch	
8 ... 9 mm / 0.31 ... 0.35 inch	

Technical Data	
0.08 ... 2.5 mm ²	28 ... 14 AWG
500 V / 6 kV / 3 ①	300 V, 15 A I_N
I_N 24 A	300 V, 20 A I_{Nc}
Pole width: 6 mm / 0.236 inch	
8 ... 9 mm / 0.31 ... 0.35 inch	

- ① 500 V = rated voltage
6 kV = rated impulse voltage
3 = pollution degree
(see Section 15)
 - ② Longer strips are available upon request.
- Approvals and corresponding ratings, visit www.wago.com

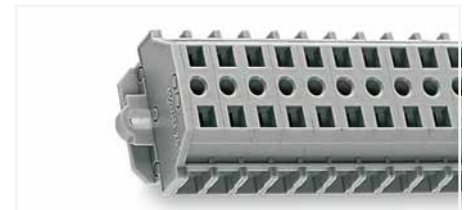
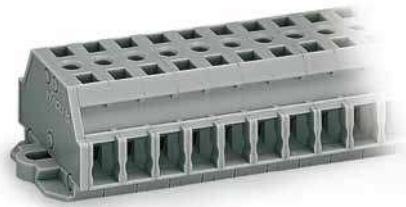

Dimensions in mm

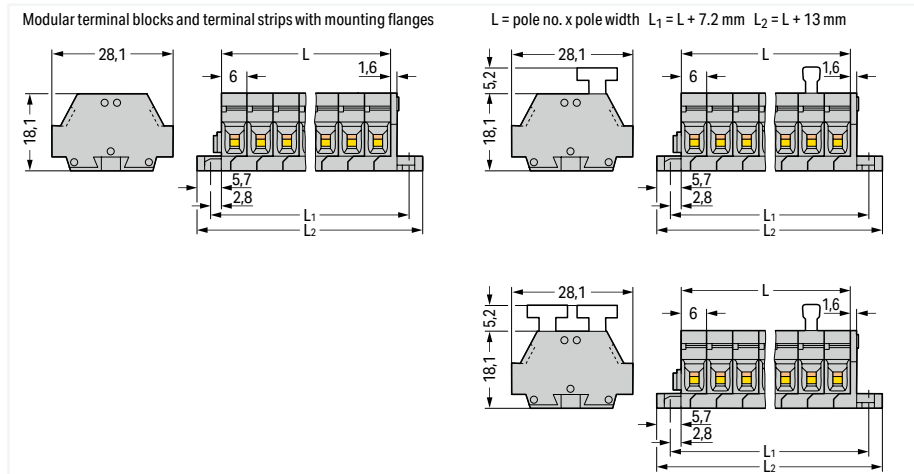

Terminal strip; with mounting flanges; for screw or similar mounting types; 3.2 mm mounting hole diameter (with 209-123 Mounting Foot for DIN-35 rail)

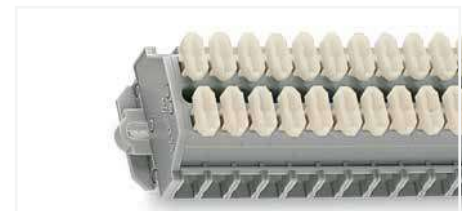

Terminal strip; with mounting flanges; for screw or similar mounting types; 3.2 mm mounting hole diameter (with 209-123 Mounting Foot for DIN-35 rail)

2-conductor terminal strip; with mounting flanges; for screw or similar mounting types; 3.2 mm mounting hole diameter; with mounting foot (209-123) also for DIN-35 rail; gray

Pole No.	Item No.	Pack. Unit
○ 2	261-422	100
○ 3	261-423	100
○ 4	261-424	100
○ 5	261-425	200
○ 6	261-426	50
○ 7	261-427	50
○ 8	261-428	50
○ 9	261-429	50
○ 10	261-430	25
○ 11	261-431	25
○ 12 ②	261-432	25

2-conductor terminal strip; with push-buttons on one side; with mounting flanges; for screw or similar mounting types; 3.2 mm mounting hole diameter; with mounting foot (209-123) also for DIN-35 rail; gray

Pole No.	Item No.	Pack. Unit
○ 2	261-422/331-000	100
○ 3	261-423/331-000	100
○ 4	261-424/331-000	100
○ 5	261-425/331-000	100
○ 6	261-426/331-000	50
○ 7	261-427/331-000	50
○ 8	261-428/331-000	50
○ 9	261-429/331-000	50
○ 10	261-430/331-000	25
○ 11	261-431/331-000	25
○ 12 ②	261-432/331-000	25

2-conductor terminal strip; with push-buttons on both sides; with mounting flanges; for screw or similar mounting types; 3.2 mm mounting hole diameter; with mounting foot (209-123) also for DIN-35 rail; gray

Pole No.	Item No.	Pack. Unit
○ 2	261-422/341-000	100
○ 3	261-423/341-000	100
○ 4	261-424/341-000	100
○ 5	261-425/341-000	100
○ 6	261-426/341-000	50
○ 7	261-427/341-000	50
○ 8	261-428/341-000	50
○ 9	261-429/341-000	50
○ 10	261-430/341-000	25
○ 11	261-431/341-000	25
○ 12 ②	261-432/341-000	25

Modular Terminal Block; with Mounting Flange or Snap-In Mounting Foot

4 mm²; 262 Series

Technical Data

0.08 ... 4 mm ²	28 ... 12 AWG
630 V / 8 kV / 3 ①	300 V, 20 A
I _N 24 A	300 V, 20 A
Terminal block width: 7 mm / 0.276 inch	
9 ... 10 mm / 0.35 ... 0.39 inch	

Technical Data

0.08 ... 4 mm ²	28 ... 12 AWG
630 V / 8 kV / 3 ①	300 V, 20 A
I _N 32 A	300 V, 20 A
Terminal block width: 12 mm / 0.472 inch	
9 ... 10 mm / 0.35 ... 0.39 inch	

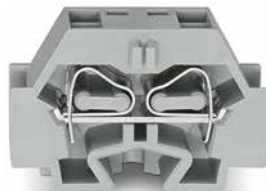
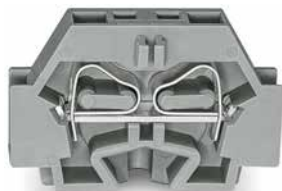

2-conductor terminal block; with mounting flange; for screw or similar mounting types; 3.2 mm mounting hole diameter; with mounting foot (209-123) also for DIN-35 rail

Color	Item No.	Pack. Unit
gray	262-301	100 (50)
blue	262-304 ②	100 (50)
orange	262-306	100 (50)
green-yellow	262-307	100 (50)

4-conductor terminal block; with mounting flange; for screw or similar mounting types; 3.2 mm mounting hole diameter; with mounting foot (209-123) also for DIN-35 rail

Color	Item No.	Pack. Unit
gray	262-331	100 (50)
blue	262-334 ②	100 (50)
orange	262-336	100 (50)
green-yellow	262-337	100 (50)

2-conductor terminal block; with snap-in mounting foot; for 0.6 ... 1.2 mm plate thickness; 3.5 mm mounting hole diameter; also for aluminum rail (210-154) or with mounting foot (209-120) for DIN-35 rail

gray	262-311	100 (50)
blue	262-314 ②	100 (50)
orange	262-316	100 (50)
green-yellow	262-317	100 (50)

4-conductor terminal block; with snap-in mounting foot; for 0.6 ... 1.2 mm plate thickness; 3.5 mm mounting hole diameter; also for aluminum rail (210-154) or with mounting foot (209-120) for DIN-35 rail

gray	262-341	100 (50)
blue	262-344 ②	100 (50)
orange	262-346	100 (50)
green-yellow	262-347	100 (50)

Space-saving 2-conductor end terminal block; without protruding snap-in mounting foot; for terminal strips with snap-in mounting feet

gray	262-321	100 (50)
blue	262-324 ②	100 (50)
orange	262-326	100 (50)
green-yellow	262-327	100 (50)

Space-saving 4-conductor end terminal block; without protruding snap-in mounting foot; for terminal strips with snap-in mounting feet

gray	262-351	100 (50)
blue	262-354 ②	100 (50)
orange	262-356	100 (50)
green-yellow	262-357	100 (50)

Accessories; item-specific

Test plug module; snaps together; 7 mm wide

gray	249-137	100 (25)
------	---------	----------

Accessories; item-specific

Test plug module; snaps together; 12 mm wide

gray	249-140	100 (25)
------	---------	----------

Accessories; 262 Series

Marking accessories, see Section 14

End plate; with mounting flange

gray	262-361	300 (50)
------	---------	----------

Test plug; with 500 mm cable; 2 mm Ø; max. 42 V

red	210-136	50
-----	---------	----

End plate; with snap-in mounting foot

gray	262-371	300 (50)
------	---------	----------

Aluminum mounting rail; 1000 mm long; 18 mm wide; 7 mm high

	210-154	1
--	---------	---

Comb-style jumper bar; insulated; reduces maximum conductor size to 2.5 mm²; I_N 16 A; gray

2-way	262-402	25
-------	---------	----

Plastic end stop; with WSB marker slot; for aluminum rail (210-154); 6 mm wide

	209-122	25
--	---------	----

Operating tool; insulated; for comb-style jumper bar

2-way	209-132	1
-------	---------	---

① 630 V = rated voltage
8 kV = rated impulse voltage
3 = pollution degree
(see Section 15)

② Terminal blocks with a blue insulated housing are suitable for Ex i applications.

See application notes for:
Test plug module, page 420

Approvals and corresponding ratings,
visit www.wago.com

Accessories; 262 Series

Marking accessories, see Section 14

Mounting foot; for DIN-35 rail; snaps onto terminal blocks with snap-in mounting foot; 6.4 mm wide

gray	209-120	25
------	---------	----

Mounting screw; for mounting foot (209-120)

	209-119	500 (50)
--	---------	----------

Mounting foot with screw; for DIN-35 rail; can be screwed on terminal blocks with mounting flange; 6.4 mm wide

gray	209-123	25
------	---------	----

Mounting adapter; for DIN-35 rail; can be used as end plate; 6.5 mm wide

gray	209-137	25
------	---------	----

Operating tool with a partially insulated shaft; Type 2; (3.5 x 0.5) mm blade

	210-720	1
--	---------	---

Terminal Strip; with Mounting Flanges or Snap-in Mounting Feet 4 mm²; 262 Series

Technical Data	
0.08 ... 4 mm ²	28 ... 12 AWG
630 V / 8 kV / 3 ❶	300 V, 20 A ❷
I _N 24 A	300 V, 20 A ❸
Pole width: 7 mm / 0.276 inch	
9 ... 10 mm / 0.35 ... 0.39 inch	

Technical Data	
0.08 ... 4 mm ²	28 ... 12 AWG
630 V / 8 kV / 3 ❶	300 V, 20 A ❷
I _N 32 A	300 V, 20 A ❸
Pole width: 12 mm / 0.472 inch	
9 ... 10 mm / 0.35 ... 0.39 inch	

- ❶ 630 V = rated voltage
8 kV = rated impulse voltage
3 = pollution degree
(see Section 15)
 - ❷ Terminal strips with a blue insulated housing are suitable for Ex i applications.
Item no. suffixes .../000-006 (upon request)
 - ❸ Longer strips and/or mixed-color assemblies are available upon request.
- Approvals and corresponding ratings, visit www.wago.com

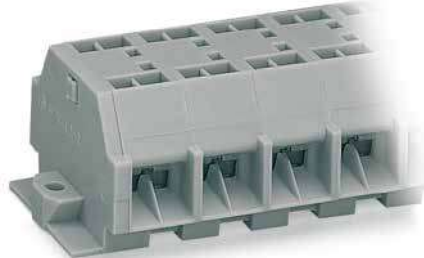
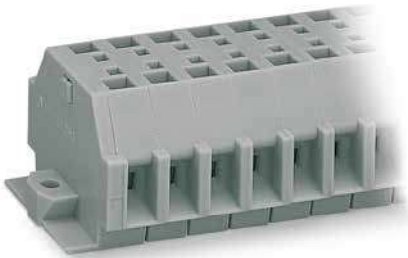

Dimensions in mm

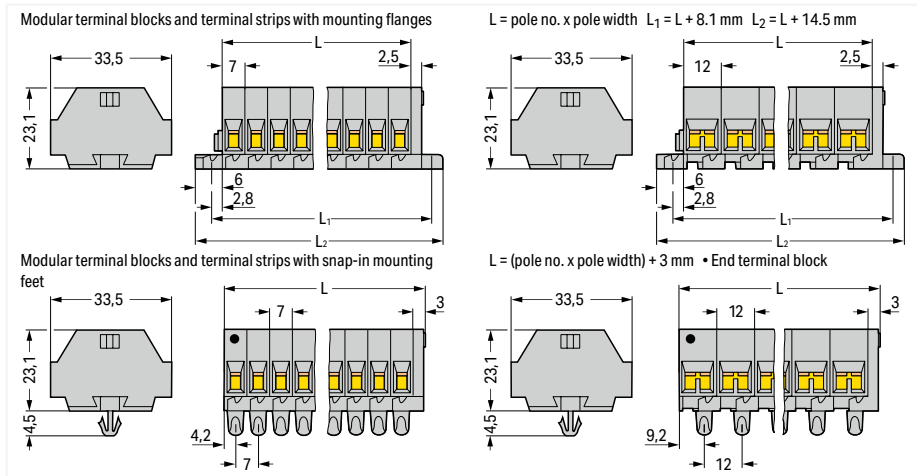

Terminal strip; with mounting flanges; for screw or similar mounting types; 3.2 mm mounting hole diameter (with 209-123 Mounting Foot for DIN-35 rail)



Terminal strip; with snap-in mounting feet; for 0.6 ... 1.2 mm plate thickness; 3.5 mm mounting hole diameter (also for 210-154 Aluminum Rail or with 209-120 Mounting Foot for DIN-35 rail)

2-conductor terminal strip; with mounting flanges; for screw or similar mounting types; 3.2 mm mounting hole diameter; with mounting foot (209-123) also for DIN-35 rail; gray ❷

Pole No.	Item No.	Pack. Unit
○ 2	262-102	100
○ 3	262-103	100
○ 4	262-104	100
○ 5	262-105	100
○ 6	262-106	100
○ 7	262-107	100
○ 8	262-108	100
○ 9	262-109	50
○ 10	262-110	25
○ 11	262-111	25
○ 12 ❸	262-112	25

4-conductor terminal strip; with mounting flanges; for screw or similar mounting types; 3.2 mm mounting hole diameter; with mounting foot (209-123) also for DIN-35 rail; gray ❷

Pole No.	Item No.	Pack. Unit
○ 2	262-202	100
○ 3	262-203	100
○ 4	262-204	100
○ 5	262-205	100
○ 6	262-206	50
○ 7	262-207	50
○ 8	262-208	50
○ 9	262-209	50
○ 10	262-210	25
○ 11	262-211	25
○ 12 ❸	262-212	25

2-conductor terminal strip; with snap-in mounting feet; for 0.6 ... 1.2 mm plate thickness; 3.5 mm mounting hole diameter; also for aluminum rail (210-154) or with mounting foot (209-120) for DIN-35 rail; gray ❷

Pole No.	Item No.	Pack. Unit
○ 2	262-152	100
○ 3	262-153	100
○ 4	262-154	100
○ 5	262-155	100
○ 6	262-156	50
○ 7	262-157	50
○ 8	262-158	50
○ 9	262-159	50
○ 10	262-160	25
○ 11	262-161	25
○ 12 ❸	262-162	25

4-conductor terminal strip; with snap-in mounting feet; for 0.6 ... 1.2 mm plate thickness; 3.5 mm mounting hole diameter; also for aluminum rail (210-154) or with mounting foot (209-120) for DIN-35 rail; gray ❷

Pole No.	Item No.	Pack. Unit
○ 2	262-252	100
○ 3	262-253	100
○ 4	262-254	100
○ 5	262-255	100
○ 6	262-256	50
○ 7	262-257	50
○ 8	262-258	50
○ 9	262-259	50
○ 10	262-260	25
○ 11	262-261	25
○ 12 ❸	262-262	25

Modular Ex Terminal Block; with Mounting Flange or Snap-In Mounting Foot 4 mm²; 262 Series

Technical Data

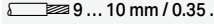
0.5 ... 4 mm² ①	28 ... 12 AWG
550 V	300 V, 20 A ②
I _N 23 A	300 V, 20 A ③
Terminal block width: 7 mm / 0.276 inch	
 9 ... 10 mm / 0.35 ... 0.39 inch	

Technical Data

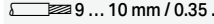
0.5 ... 4 mm² ①	28 ... 12 AWG
550 V	300 V, 20 A ②
I _N 30 A	300 V, 20 A ③
Terminal block width: 12 mm / 0.472 inch	
 9 ... 10 mm / 0.35 ... 0.39 inch	

① Using crimped ferrules for corrosion protection, the rated cross section is reduced by one size. For conductor types and conductor preparation, see Section 15 "Electrical Equipment for Hazardous Environments."

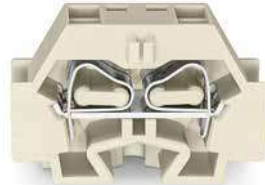

2-conductor Ex e II terminal block; with mounting flange; for screw or similar mounting types; 3.2 mm mounting hole diameter; with mounting foot (209-123) also for DIN-35 rail

Color	Item No.	Pack. Unit
○ light gray ④	262-130	100 (50)

4-conductor Ex e II terminal block; with mounting flange; for screw or similar mounting types; 3.2 mm mounting hole diameter; with mounting foot (209-123) also for DIN-35 rail

Color	Item No.	Pack. Unit
○ light gray ④	262-230	100 (50)

2-conductor Ex e II terminal block; with snap-in mounting foot; for 0.6 ... 1.2 mm plate thickness; 3.5 mm mounting hole diameter; also for aluminum rail (210-154) or with mounting foot (209-120) for DIN-35 rail

○ light gray ④	262-180	100 (50)
----------------	---------	----------

4-conductor Ex e II terminal block; with snap-in mounting foot; for 0.6 ... 1.2 mm plate thickness; 3.5 mm mounting hole diameter; also for aluminum rail (210-154) or with mounting foot (209-120) for DIN-35 rail

○ light gray ④	262-280	100 (50)
----------------	---------	----------

Space-saving 2-conductor Ex e II end terminal block; without protruding snap-in mounting foot; for terminal strips with snap-in mounting feet

○ light gray ④	262-181	100 (50)
----------------	---------	----------

Space-saving 4-conductor Ex e II end terminal block; without protruding snap-in mounting foot; for terminal strips with snap-in mounting feet

○ light gray ④	262-281	100 (50)
----------------	---------	----------

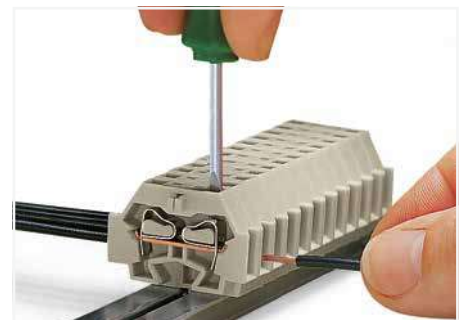

CAGE CLAMP® termination: Inserting a conductor.

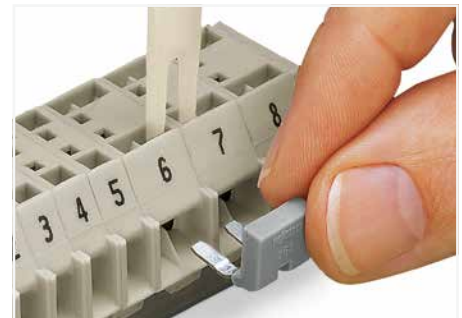

Commoning with comb-style jumper bar.

Accessories; 262 Series

Marking accessories, see Section 14

End plate; with mounting flange

	light gray	262-363	50
--	------------	---------	----

Mounting foot; for DIN-35 rail; snaps onto terminal blocks with snap-in mounting foot; 6.4 mm wide

	gray	209-120	25
---	------	---------	----

End plate; with snap-in mounting foot

	light gray	262-373	50
--	------------	---------	----

Mounting screw; for mounting foot (209-120)

		209-119	500 (50)
--	--	---------	----------

Comb-style jumper bar; insulated; reduces maximum conductor size to 2.5 mm²; I_N 16 A; gray

	2-way	262-402	25
--	-------	---------	----

Mounting foot with screw; for DIN-35 rail; can be screwed on terminal blocks with mounting flange; 6.4 mm wide

	gray	209-123	25
---	------	---------	----

Operating tool; insulated; for comb-style jumper bar

	2-way	209-132	1
--	-------	---------	---

Mounting adapter; for DIN-35 rail; can be used as end plate; 6.5 mm wide

	gray	209-137	25
---	------	---------	----

Aluminum mounting rail; 1000 mm long; 18 mm wide; 7 mm high

		210-154	1
--	--	---------	---

Operating tool with a partially insulated shaft; Type 2; (3.5 x 0.5) mm blade

		210-720	1
---	--	---------	---

Plastic end stop; with WSB marker slot; for aluminum rail (210-154); 6 mm wide

		209-122	25
--	--	---------	----

Ex Terminal Strip; with Mounting Flanges or Snap-in Mounting Feet 4 mm²; 262 Series

Technical Data	
0.5 ... 4 mm² ①	28 ... 12 AWG
550 V	300 V, 20 A A
I _N 23 A	300 V, 20 A A
Pole width: 7 mm / 0.276 inch	
9 ... 10 mm / 0.35 ... 0.39 inch	

Technical Data	
0.5 ... 4 mm² ①	28 ... 12 AWG
550 V	300 V, 20 A A
I _N 30 A	300 V, 20 A A
Pole width: 12 mm / 0.472 inch	
9 ... 10 mm / 0.35 ... 0.39 inch	

- ① Using crimped ferrules for corrosion protection, the rated cross section is reduced by one size. For conductor types and conductor preparation, see Section 15 "Electrical Equipment for Hazardous Environments."
- ② Longer strips and/or mixed-color assemblies are available upon request.

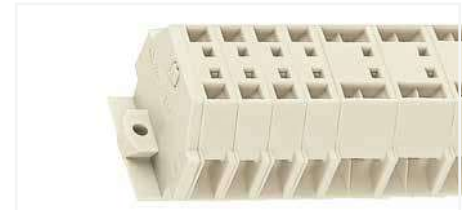
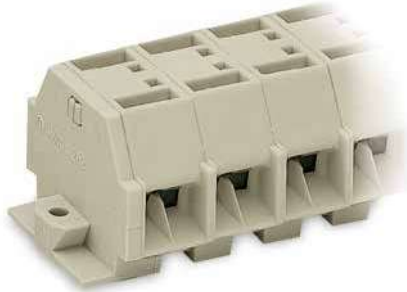

Dimensions in mm

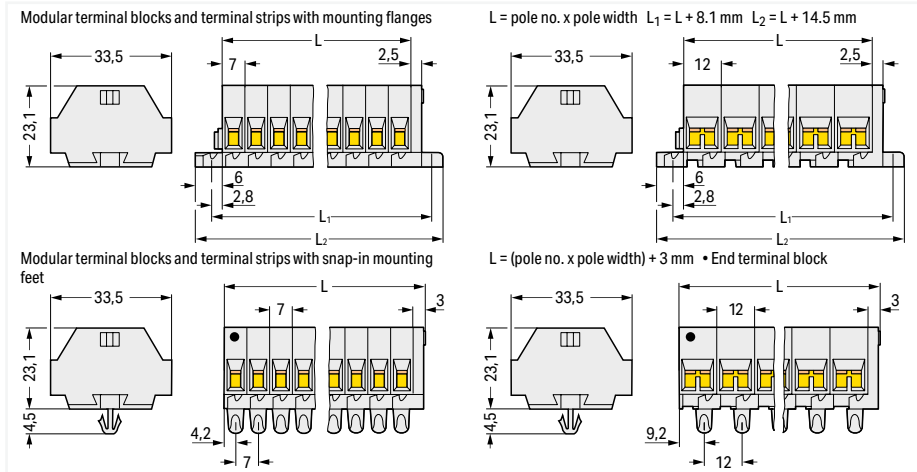

Terminal strip; with mounting flanges; for screw or similar mounting types; 3.2 mm mounting hole diameter (with 209-123 Mounting Foot for DIN-35 rail)

2-conductor Ex e II terminal strip; with mounting flanges; for screw or similar mounting types; 3.2 mm mounting hole diameter; with mounting foot (209-123) also for DIN-35 rail; gray

4-conductor Ex e II terminal strip; with mounting flanges; for screw or similar mounting types; 3.2 mm mounting hole diameter; with mounting foot (209-123) also for DIN-35 rail; gray



Terminal strip; with snap-in mounting feet; for 0.6 ... 1.2 mm plate thickness; 3.5 mm mounting hole diameter (also for 210-154 Aluminum Rail or with 209-120 Mounting Foot for DIN-35 rail)

Pole No.	Item No.	Pack. Unit
○ 2 A	262-132	100
○ 3 A	262-133	100
○ 4 A	262-134	100
○ 5 A	262-135	100
○ 6 A	262-136	100
○ 7 A	262-137	50
○ 8 A	262-138	50
○ 9 A	262-139	50
○ 10 A	262-140	25
○ 11 A	262-141	25
○ 12 A ②	262-142	25

Pole No.	Item No.	Pack. Unit
○ 2 A	262-232	100
○ 3 A	262-233	100
○ 4 A	262-234	100
○ 5 A	262-235	100
○ 6 A	262-236	50
○ 7 A	262-237	50
○ 8 A	262-238	50
○ 9 A	262-239	50
○ 10 A	262-240	25
○ 11 A	262-241	25
○ 12 A ②	262-242	25

2-conductor Ex e II terminal strip; with snap-in mounting feet; for 0.6 ... 1.2 mm plate thickness; 3.5 mm mounting hole diameter; also for aluminum rail (210-154) or with mounting foot (209-120) for DIN-35 rail; gray

4-conductor Ex e II terminal strip; with snap-in mounting feet; for 0.6 ... 1.2 mm plate thickness; 3.5 mm mounting hole diameter; also for aluminum rail (210-154) or with mounting foot (209-120) for DIN-35 rail; gray

Pole No.	Item No.	Pack. Unit
○ 2 A	262-182	100
○ 3 A	262-183	100
○ 4 A	262-184	100
○ 5 A	262-185	100
○ 6 A	262-186	50
○ 7 A	262-187	50
○ 8 A	262-188	50
○ 9 A	262-189	50
○ 10 A	262-190	25
○ 11 A	262-191	25
○ 12 A ②	262-192	25

Pole No.	Item No.	Pack. Unit
○ 2 A	262-282	100
○ 3 A	262-283	100
○ 4 A	262-284	100
○ 5 A	262-285	100
○ 6 A	262-286	50
○ 7 A	262-287	50
○ 8 A	262-288	50
○ 9 A	262-289	50
○ 10 A	262-290	25
○ 11 A	262-291	25
○ 12 A ②	262-292	25

Test Plug Module; for Terminal Strips without Push-Buttons 260, 261 and 262 Series

Technical Data

for 260 Series

Test voltage: 250 V / 500 V ①

Test current: 0.5 A / 6 A ②

Middle pressure: 2.2 N per pole



Technical Data

for 261 Series (also 264 Series)

Test voltage: 400 V / 800 V ①

Test current: 0.5 A / 6 A ②

Middle pressure: 2.2 N per pole



Technical Data

for 262 Series

Test voltage: 500 V / 800 V ①

Test current: 0.5 A / 6 A ②

Middle pressure: 2.2 N per pole



Test plug module; without locking latches; snaps together; for 2-conductor terminal blocks
Module width: 5 mm

Color	Item No.	Pack. Unit
<input type="radio"/> gray	249-135	100 (25)

Test plug module; without locking latches; snaps together; for 2-conductor terminal blocks
Module width: 6 mm

Color	Item No.	Pack. Unit
<input type="radio"/> gray	249-136	100 (25)

Test plug module; without locking latches; snaps together; for 2-conductor terminal blocks
Module width: 7 mm

Color	Item No.	Pack. Unit
<input type="radio"/> gray	249-137	100 (25)

Test plug module; without locking latches; snaps together; for 4-conductor terminal blocks
Module width: 8 mm

<input type="radio"/> gray	249-138	100 (25)
----------------------------	---------	----------

Test plug module; without locking latches; snaps together; for 4-conductor terminal blocks
Module width: 10 mm

<input type="radio"/> gray	249-139	100 (25)
----------------------------	---------	----------

Test plug module; without locking latches; snaps together; for 4-conductor terminal blocks
Module width: 12 mm

<input type="radio"/> gray	249-140	100 (25)
----------------------------	---------	----------

Test plug module; with locking latches; snaps together; for 2-conductor terminal blocks
Module width: 5 mm

<input type="radio"/> gray	260-404	100 (25)
----------------------------	---------	----------

Test plug module; with locking latches; snaps together; for 2-conductor terminal blocks
Module width: 6 mm

<input type="radio"/> gray	261-404	100 (25)
----------------------------	---------	----------

Test plug module; with locking latches; snaps together; for 4-conductor terminal blocks
Module width: 8 mm

<input type="radio"/> gray	260-405	100 (25)
----------------------------	---------	----------

Test plug module; without locking latches; snaps together; for 4-conductor terminal blocks
Module width: 10 mm

<input type="radio"/> gray	261-405	100 (25)
----------------------------	---------	----------

Accessories; for L-type test plug modules

Test plug; with 500 mm cable; 2 mm Ø; max. 42 V



red	210-136	50
-----	---------	----

- 1 Maximum test voltage (touch contact): 48 V (test pins are not touch-proof)
- 2 Maximum test current (touch contact): 0.5 A
Maximum test current: 6 A (if the test pins are securely connected in the clamping units)

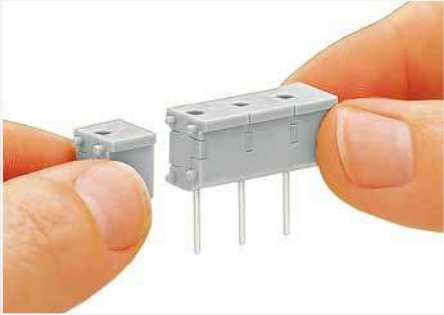

Snapping individual modules together to assemble a multi-pole test plug module.

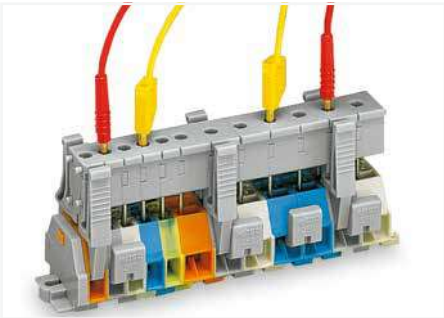

Testing via test plug modules snapped onto a terminal strip – wired or unwired. As touch contact is made with the CAGE CLAMP® (spring steel) unit, this testing type is limited to maximum 0.5 A.

Distance between locking devices must be approximately 35 ... 40 mm.



Testing after the conductors have been terminated.





WAGO Chassis-Mount Terminal Strips
WAGO Field-Wiring Terminal Blocks

PUSH-IN CAGE CLAMP® **PUSH WIRE®**

WAGO Chassis-Mount Terminal Strips

WAGO Field-Wiring Terminal Blocks

			Page
	4-Conductor Chassis-Mount Terminal Strips 0.5 ... 4 mm ² (20 ... 12 AWG)	862 Series	558
	Field-Wiring Terminal Blocks 0.5 ... 2.5 mm ² (18 ... 12 AWG)	294 Series	567

4-Conductor Chassis-Mount Terminal Strips

862 Series

Description and Installation

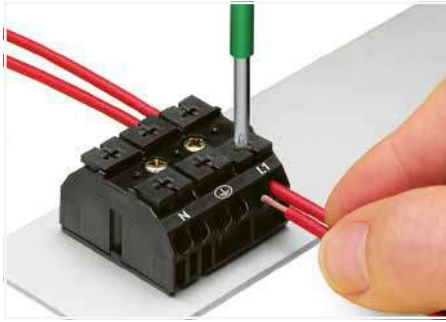

Terminating four conductors per pole – solid and fine-stranded.



Inserting a conductor via push-button.



Testing with a 2 mm Ø test plug (max. 42 V).



Makes an automatic contact to the mounting plate. The plate's varnish is instantly penetrated.

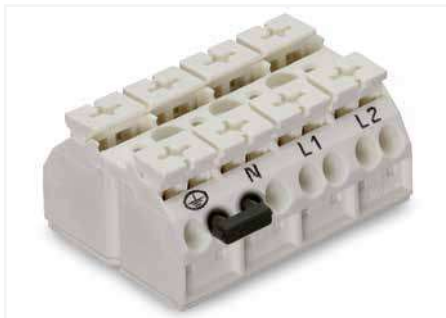

Commoning using a comb-style jumper bar (862-482).

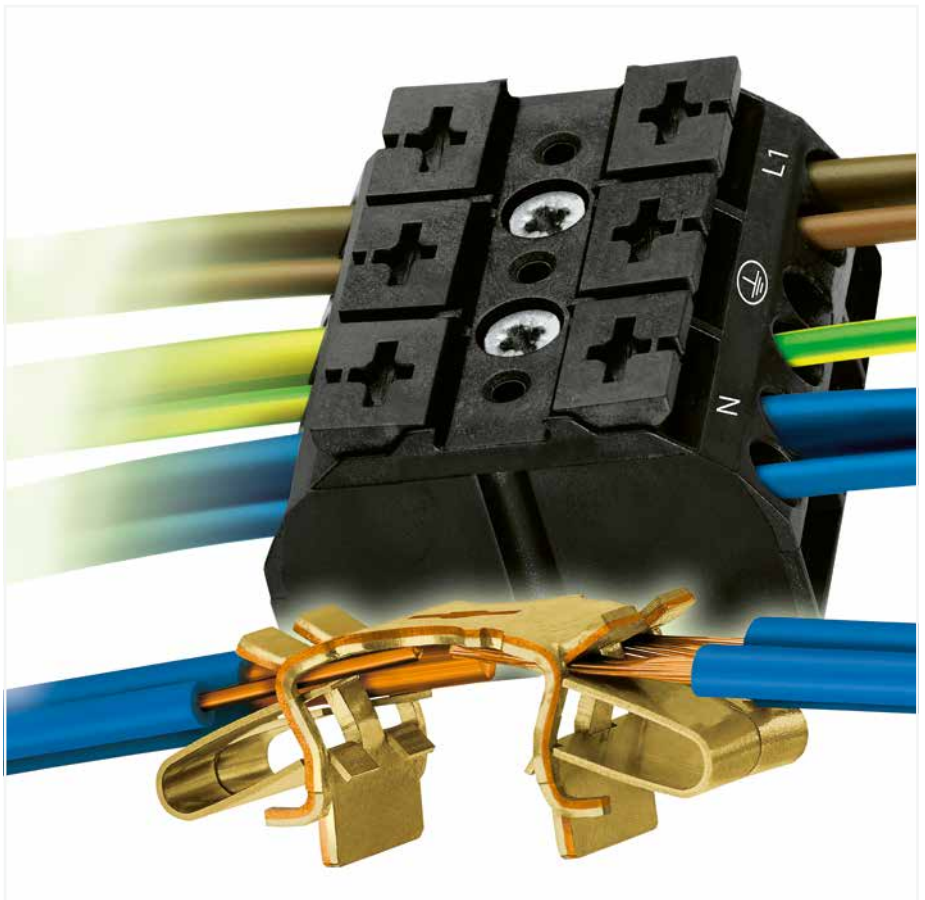

10

Cost-Effective Features:

WAGO's 862 Series Chassis-Mount Terminal Strips were developed specifically to minimize wiring costs, while accommodating requirements for flexible mounting, multiple connection points and easy usage:

- Equipped with Push-in CAGE CLAMP®, the 862 Series connects up to four conductors sized 0.5 to 4 mm² (20 ... 12 AWG). Due to multiple connection points per pole, different conductor sizes can be used within the same terminal block position.

- For factory wiring, Push-in CAGE CLAMP® connection technology allows solid conductors, ultrasonically bonded conductors from 0.5 ... 4 mm² (20 ... 12 AWG; length of bonded conductor end: min. 10 mm) or fine-stranded conductors with ferrules from 1 to 2.5 mm² (18 ... 14 AWG) to be terminated by simply pushing them into the unit.
- Convenient automatic grounding contact (optional)
- Snap-in mounting feet for fast assembly
- Push-buttons for easy installation with an operating tool or by hand
- Built-in test points simplify testing with 2 mm Ø test plug
- Flexible marking options with standard marking (pre-marked), marking strip or custom marked for large orders

Push-in CAGE CLAMP® terminates the following copper conductors:
solid "s" stranded "st"

fine-stranded "f-st", also with tinned single strands

fine-stranded, tip-bonded

fine-stranded, with ferrule (gastight crimped)

fine-stranded, with pin terminal (gastight crimped)

With ferruled conductors, it is necessary to use a terminal block one size smaller than the conductor's nominal cross section.

Mounting Types

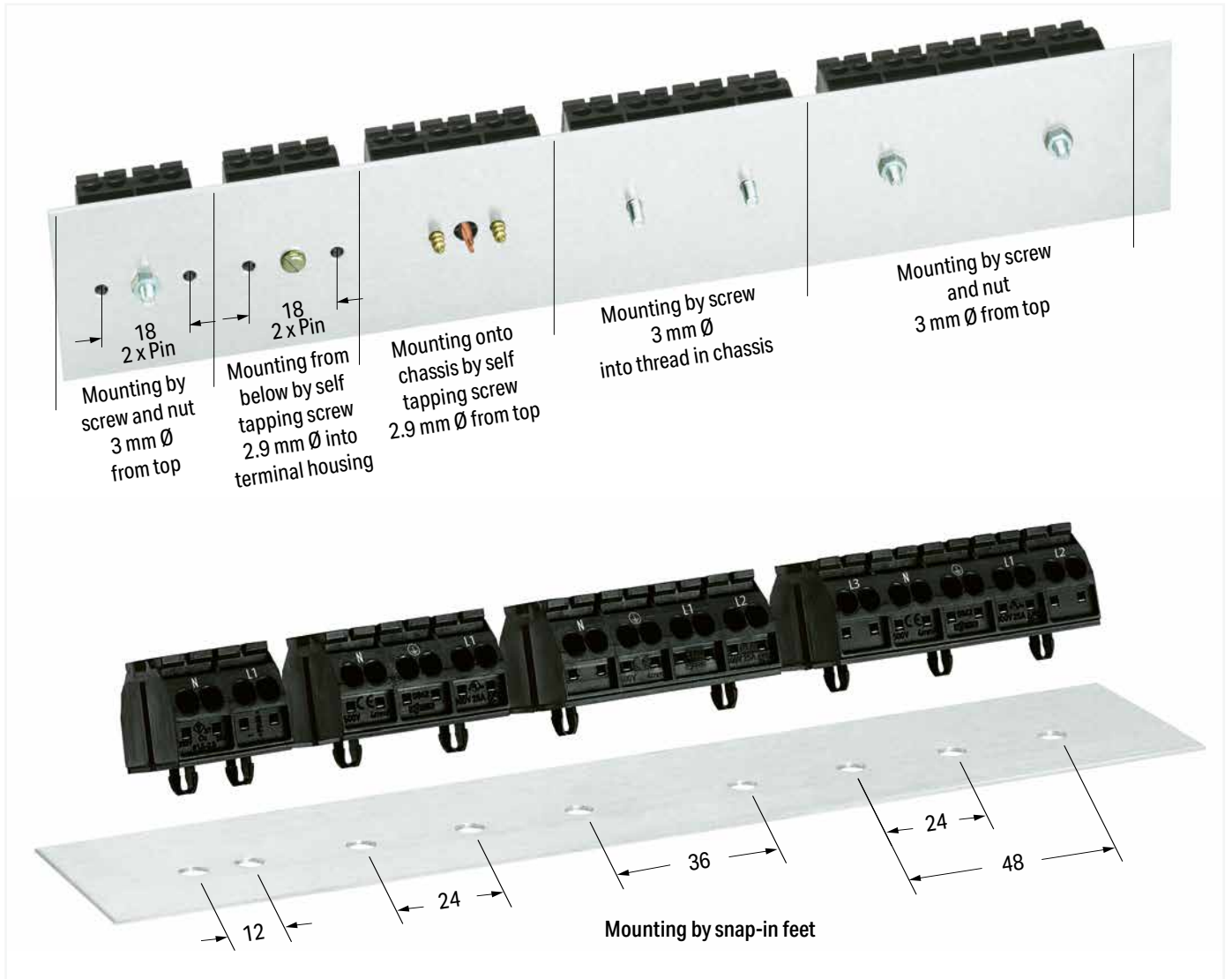

Dimensions in mm

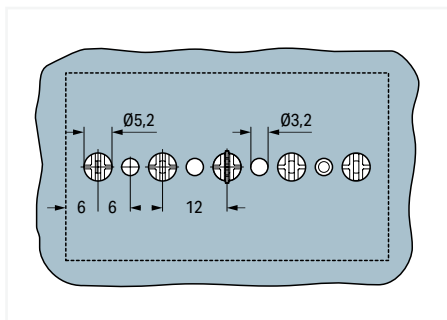

Dimensions (in mm) for ground contact and snap-in mounting foot (5.2 mm Ø)

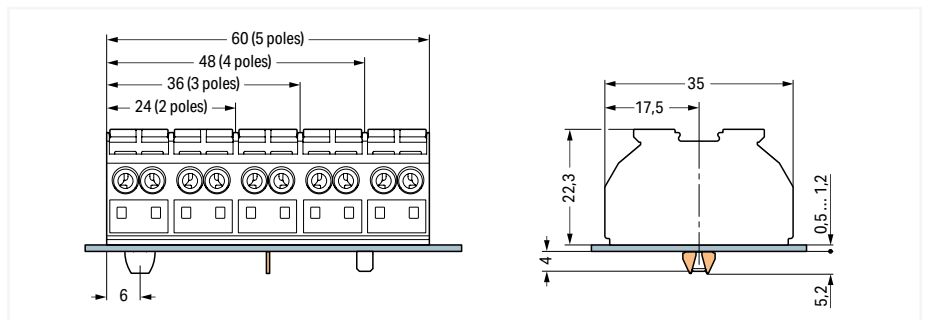

Dimensions (in mm) for chassis-mount terminal strips

4-Conductor Chassis-Mount Terminal Strip; 2-Pole 4 mm²; 862 Series

Technical Data

0.5 ... 4 mm ² ①	20 ... 12 AWG
500 V / 6 kV / 3 ②	300 V, 20 A ③
I _N 32 A	300 V, 20 A ④
 10 ... 11 mm / 0.39 ... 0.43 inch	



Technical Data

0.5 ... 4 mm ² ①	20 ... 12 AWG
500 V / 6 kV / 3 ②	300 V, 20 A ③
I _N 32 A	300 V, 20 A ④
 10 ... 11 mm / 0.39 ... 0.43 inch	



① Conductor range: 0.5 ... 4 mm² "s+f-st";
Push-in termination: 0.75 ... 4 mm² "s" and 0.5 ...
1.5 mm² "insulated ferrules, 10 mm"
Depending on the conductor characteristic, a conductor
with a smaller cross section can also be inserted
via push-in termination.

② 500 V = rated voltage
6 kV = rated impulse voltage
3 = pollution degree
(see Section 15)

③ Terminal blocks with an Ex mark are suitable for Ex e II
applications.
440 V; 28 A
(see Section 15)

Approvals and corresponding ratings,
visit www.wago.com

Accessories; 862 Series

Appropriate marking system:
Marking strips

Comb-style jumper bar; for conductor entry; insulated;
terminated conductor entry; I_N 32 A

black	862-482	5
-------	---------	---



Test plug; with 500 mm cable; 2 mm Ø; max. 42 V

red	210-136	50
-----	---------	----



Marking strip; on reel; 7.5 mm wide; not stretchable; plain;
snap-on type

white	709-178	1
-------	---------	---



Operating tool with a partially insulated shaft; Type 2; (3.5
x 0.5) mm blade

	210-720	1
--	---------	---



4-conductor chassis-mount terminal strip; for mounting
via screw and nut (3 mm Ø) or for self-tapping screw
(2.9 mm Ø) from top; with 2 x pin; black

	Item No.	Pack. Unit
● N-L1	862-2552	500
● L1-N	862-1552	500
● L1-N ④	862-1552/999-950 ④	500
● plain	862-552	500

4-conductor chassis-mount terminal strip; for mounting
via screw and nut (3 mm Ø) or for self-tapping screw
(2.9 mm Ø) from top; with 2 x pin; white

	Item No.	Pack. Unit
○ N-L1	862-2652	500
○ L1-N	862-1652	500
○ L1-N ④	862-1652/999-950 ④	500
○ plain	862-652	500

4-conductor chassis-mount terminal strip; for self-tap-
ping screw (2.9 mm Ø) from below; with 2 x pin; black

● N-L1	862-2562	500
● L1-N	862-1562	500
● L1-N ④	862-1562/999-950 ④	500
● plain	862-562	500

4-conductor chassis-mount terminal strip; for self-tap-
ping screw (2.9 mm Ø) from below; with 2 x pin; white

○ N-L1	862-2662	500
○ L1-N	862-1662	500
○ L1-N ④	862-1662/999-950 ④	500
○ plain	862-662	500

4-conductor chassis-mount terminal strip; 1 snap-in foot
per pole; black

● N-L1	862-2532	500
● L1-N	862-1532	500
● L1-N ④	862-1532/999-950 ④	500
● plain	862-532	500

4-conductor chassis-mount terminal strip; 1 snap-in foot
per pole; white

○ N-L1	862-2632	500
○ L1-N	862-1632	500
○ L1-N ④	862-1632/999-950 ④	500
○ plain	862-632	500

4-Conductor Chassis-Mount Terminal Strip; 3-Pole 4 mm²; 862 Series

Technical Data

0.5 ... 4 mm ² ①	20 ... 12 AWG
500 V / 6 kV / 3 ②	300 V, 20 A
I _N 32 A	300 V, 20 A
10 ... 11 mm / 0.39 ... 0.43 inch	



Technical Data

0.5 ... 4 mm ² ①	20 ... 12 AWG
500 V / 6 kV / 3 ②	300 V, 20 A
I _N 32 A	300 V, 20 A
10 ... 11 mm / 0.39 ... 0.43 inch	



① Conductor range: 0.5 ... 4 mm² "s+f-st";
Push-in termination: 0.75 ... 4 mm² "s" and 0.5 ...
1.5 mm² "insulated ferrules, 10 mm"
Depending on the conductor characteristic, a conductor
with a smaller cross section can also be inserted
via push-in termination.

② 500 V = rated voltage
6 kV = rated impulse voltage
3 = pollution degree
(see Section 15)

③ Terminal blocks with an Ex mark are suitable for Ex II
applications.
440 V; 28 A
(see Section 15)

Approvals and corresponding ratings,
visit www.wago.com

Accessories; 862 Series

Appropriate marking system:
Marking strips

Comb-style jumper bar; for conductor entry; insulated;
terminated conductor entry; I_N 32 A

black 862-482 5

Test plug; with 500 mm cable; 2 mm Ø; max. 42 V

red 210-136 50

Marking strip; on reel; 7.5 mm wide; not stretchable; plain;
snap-on type

white 709-178 1

Operating tool with a partially insulated shaft; Type 2; (3.5
x 0.5) mm blade

210-720 1

4-conductor chassis-mount terminal strip; for mounting
via screw and nut (3 mm Ø) or for self-tapping screw
(2.9 mm Ø) from top; black

	Item No.	Pack. Unit
● N-PE-L1; without ground contact	862-2503	250
● PE-N-L1; without ground contact	862-1503	250
● PE-N-L1; without ground contact	862-1503/999-950 ③	250
● plain; without ground contact	862-503	250
● N-PE-L1; with ground contact	862-8503	250
● PE-L1-N; with ground contact	862-9503	250

4-conductor chassis-mount terminal strip; for mounting
via screw and nut (3 mm Ø) or for self-tapping screw
(2.9 mm Ø) from top; white

	Item No.	Pack. Unit
○ N-PE-L1; without ground contact	862-2603	250
○ PE-N-L1; without ground contact	862-1603	250
○ PE-N-L1; without ground contact	862-1603/999-950 ③	250
○ plain; without ground contact	862-603	250
○ N-PE-L1; with ground contact	862-8603	250
○ PE-L1-N; with ground contact	862-9603	250

4-conductor chassis-mount terminal strip; 1 snap-in foot
per pole; black

● N-PE-L1; without ground contact	862-2533	250
● PE-N-L1; without ground contact	862-1533	250
● PE-N-L1; without ground contact	862-1533/999-950 ③	250
● plain; without ground contact	862-533	250
● N-PE-L1; with ground contact	862-8533	250
● PE-L1-N; with ground contact	862-9533	250

4-conductor chassis-mount terminal strip; 1 snap-in foot
per pole; white

○ N-PE-L1; without ground contact	862-2633	250
○ PE-N-L1; without ground contact	862-1633	250
○ PE-N-L1; without ground contact	862-1633/999-950 ③	250
○ plain; without ground contact	862-633	250
○ N-PE-L1; with ground contact	862-8633	250
○ PE-L1-N; with ground contact	862-9633	250

4-conductor chassis-mount terminal strip; Snap-in foot
at pos. 1+3; black

● N-PE-L1; without ground contact	862-2593	250
● PE-N-L1; without ground contact	862-1593	250
● PE-N-L1; without ground contact	862-1593/999-950 ③	250
● plain; without ground contact	862-593	250
● N-PE-L1; with ground contact	862-8593	250
● PE-N-L1; with ground contact	862-9593	250

4-conductor chassis-mount terminal strip; Snap-in foot
at pos. 1+3; white

○ N-PE-L1; without ground contact	862-2693	250
○ PE-N-L1; without ground contact	862-1693	250
○ PE-N-L1; without ground contact	862-1693/999-950 ③	250
○ plain; without ground contact	862-693	250
○ N-PE-L1; with ground contact	862-8693	250
○ PE-N-L1; with ground contact	862-9693	250

4-Conductor Chassis-Mount Terminal Strip; 4-Pole 4 mm²; 862 Series

Technical Data

0.5 ... 4 mm ² ①	20 ... 12 AWG
500 V / 6 kV / 3 ②	300 V, 20 A ③
I _N 32 A	300 V, 20 A ④
 10 ... 11 mm / 0.39 ... 0.43 inch	

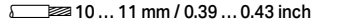

Technical Data

0.5 ... 4 mm ² ①	20 ... 12 AWG
500 V / 6 kV / 3 ②	300 V, 20 A ③
I _N 32 A	300 V, 20 A ④
 10 ... 11 mm / 0.39 ... 0.43 inch	

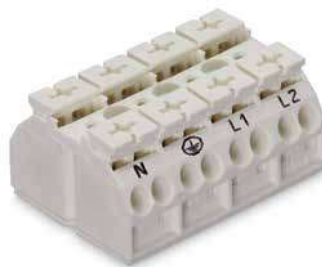

① Conductor range: 0.5 ... 4 mm² "s+f-st"; Push-in termination: 0.75 ... 4 mm² "s" and 0.5 ... 1.5 mm² "insulated ferrules, 10 mm"
Depending on the conductor characteristic, a conductor with a smaller cross section can also be inserted via push-in termination.

② 500 V = rated voltage
6 kV = rated impulse voltage
3 = pollution degree (see Section 15)

③ Terminal blocks with an Ex mark are suitable for Ex e II applications.
440 V; 28 A (see Section 15)

Approvals and corresponding ratings, visit www.wago.com

Accessories; 862 Series

Appropriate marking system:
Marking strips

Comb-style jumper bar; for conductor entry; insulated; terminated conductor entry; I_N 32 A

black	862-482	5
-------	---------	---

Test plug; with 500 mm cable; 2 mm Ø; max. 42 V

red	210-136	50
-----	---------	----

Marking strip; on reel; 7.5 mm wide; not stretchable; plain; snap-on type

white	709-178	1
-------	---------	---

Operating tool with a partially insulated shaft; Type 2; (3.5 x 0.5) mm blade

	210-720	1
--	---------	---

4-conductor chassis-mount terminal strip; for mounting via screw and nut (3 mm Ø) or for self-tapping screw (2.9 mm Ø) from top; black

	Item No.	Pack. Unit
● N-PE-L1-L2; without ground contact	862-2504	200
● PE-N-L1-L2; without ground contact	862-1504	200
● PE-N-L1-L2; without ground contact ③	862-1504/999-950 ③	200
● plain; without ground contact	862-504	200
● N-PE-L1-L2; with ground contact	862-8504	200
● PE-N-L1-L2; with ground contact	862-9504	200

4-conductor chassis-mount terminal strip; for mounting via screw and nut (3 mm Ø) or for self-tapping screw (2.9 mm Ø) from top; white

	Item No.	Pack. Unit
○ N-PE-L1-L2; without ground contact	862-2604	200
○ PE-N-L1-L2; without ground contact	862-1604	200
○ PE-N-L1-L2; without ground contact ③	862-1604/999-950 ③	200
○ plain; without ground contact	862-604	200
○ N-PE-L1-L2; with ground contact	862-8604	200
○ PE-N-L1-L2; with ground contact	862-9604	200

4-conductor chassis-mount terminal strip; 1 snap-in foot per pole; black

	Item No.	Pack. Unit
● N-PE-L1-L2; without ground contact	862-2534	200
● PE-N-L1-L2; without ground contact	862-1534	200
● PE-N-L1-L2; without ground contact ③	862-1534/999-950 ③	200
● plain; without ground contact	862-534	200
● N-PE-L1-L2; with ground contact	862-8534	200
● PE-N-L1-L2; with ground contact	862-9534	200

4-conductor chassis-mount terminal strip; 1 snap-in foot per pole; white

	Item No.	Pack. Unit
○ N-PE-L1-L2; without ground contact	862-2634	200
○ PE-N-L1-L2; without ground contact	862-1634	200
○ PE-N-L1-L2; without ground contact ③	862-1634/999-950 ③	200
○ plain; without ground contact	862-634	200
○ N-PE-L1-L2; with ground contact	862-8634	200
○ PE-N-L1-L2; with ground contact	862-9634	200

4-conductor chassis-mount terminal strip; Snap-in foot at pos. 1+4; black

	Item No.	Pack. Unit
● N-PE-L1-L2; without ground contact	862-2594	200
● PE-N-L1-L2; without ground contact	862-1594	200
● PE-N-L1-L2; without ground contact ③	862-1594/999-950 ③	200
● plain; without ground contact	862-594	200
● N-PE-L1-L2; with ground contact	862-8594	200
● PE-N-L1-L2; with ground contact	862-9594	200

4-conductor chassis-mount terminal strip; Snap-in foot at pos. 1+4; white

	Item No.	Pack. Unit
○ N-PE-L1-L2; without ground contact	862-2694	200
○ PE-N-L1-L2; without ground contact	862-1694	200
○ PE-N-L1-L2; without ground contact ③	862-1694/999-950 ③	200
○ plain; without ground contact	862-694	200
○ N-PE-L1-L2; with ground contact	862-8694	200
○ PE-N-L1-L2; with ground contact	862-9694	200

4-Conductor Chassis-Mount Terminal Strip; 5-Pole 4 mm²; 862 Series

Technical Data

0.5 ... 4 mm ² ①	20 ... 12 AWG
500 V / 6 kV / 3 ②	300 V, 20 A
I _N 32 A	300 V, 20 A

10 ... 11 mm / 0.39 ... 0.43 inch



Technical Data

0.5 ... 4 mm ² ①	20 ... 12 AWG
500 V / 6 kV / 3 ②	300 V, 20 A
I _N 32 A	300 V, 20 A

10 ... 11 mm / 0.39 ... 0.43 inch

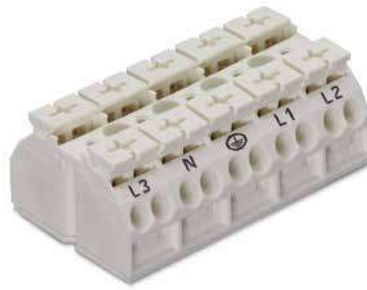

4-conductor chassis-mount terminal strip; for mounting via screw and nut (3 mm Ø) or for self-tapping screw (2.9 mm Ø) from top; black

	Item No.	Pack. Unit
● L3-N-PE-L1-L2; without ground contact	862-2505	200
● PE-N-L1-L2-L3; without ground contact	862-1505	200
● PE-N-L1-L2-L3; without ground contact	862-1505/999-950 ③	200
● plain; without ground contact	862-505	200
● L3-N-PE-L1-L2; with ground contact	862-8505	200
● PE-N-L1-L2-L3; with ground contact	862-9505	200

4-conductor chassis-mount terminal strip; for mounting via screw and nut (3 mm Ø) or for self-tapping screw (2.9 mm Ø) from top; white

	Item No.	Pack. Unit
○ L3-N-PE-L1-L2; without ground contact	862-2605	200
○ PE-N-L1-L2-L3; without ground contact	862-1605	200
○ PE-N-L1-L2-L3; without ground contact	862-1605/999-950 ③	200
○ plain; without ground contact	862-605	200
○ L3-N-PE-L1-L2; with ground contact	862-8605	200
○ PE-N-L1-L2-L3; with ground contact	862-9605	200

4-conductor chassis-mount terminal strip; Snap-in foot at pos. 2+4; black

● L3-N-PE-L1-L2; without ground contact	862-2525	200
● PE-N-L1-L2-L3; without ground contact	862-1525	200
● PE-N-L1-L2-L3; without ground contact	862-1525/999-950 ③	200
● plain; without ground contact	862-525	200
● L3-N-PE-L1-L2; with ground contact	862-8525	200
● PE-N-L1-L2-L3; with ground contact	862-9525	200

4-conductor chassis-mount terminal strip; Snap-in foot at pos. 2+4; white

○ L3-N-PE-L1-L2; without ground contact	862-2625	200
○ PE-N-L1-L2-L3; without ground contact	862-1625	200
○ PE-N-L1-L2-L3; without ground contact	862-1625/999-950 ③	200
○ plain; without ground contact	862-625	200
○ L3-N-PE-L1-L2; with ground contact	862-8625	200
○ PE-N-L1-L2-L3; with ground contact	862-9625	200

4-conductor chassis-mount terminal strip; Snap-in foot at pos. 1+3+5; black

● L3-N-PE-L1-L2; without ground contact	862-2515	200
● PE-N-L1-L2-L3; without ground contact	862-1515	200
● PE-N-L1-L2-L3; without ground contact	862-1515/999-950 ③	200
● plain; without ground contact	862-515	200
● L3-N-PE-L1-L2; with ground contact	862-8515	200
● PE-N-L1-L2-L3; with ground contact	862-9515	200

4-conductor chassis-mount terminal strip; Snap-in foot at pos. 1+3+5; white

○ L3-N-PE-L1-L2; without ground contact	862-2615	200
○ PE-N-L1-L2-L3; without ground contact	862-1615	200
○ PE-N-L1-L2-L3; without ground contact	862-1615/999-950 ③	200
○ plain; without ground contact	862-615	200
○ L3-N-PE-L1-L2; with ground contact	862-8615	200
○ PE-N-L1-L2-L3; with ground contact	862-9615	200

① Conductor range: 0.5 ... 4 mm² "s+f-st"; Push-in termination: 0.75 ... 4 mm² "s" and 0.5 ... 1.5 mm² "insulated ferrules, 10 mm"
Depending on the conductor characteristic, a conductor with a smaller cross section can also be inserted via push-in termination.

② 500 V = rated voltage
6 kV = rated impulse voltage
3 = pollution degree (see Section 15)

③ Terminal blocks with an Ex mark are suitable for Ex II applications.
440 V; 28 A (see Section 15)

Approvals and corresponding ratings, visit www.wago.com

Accessories; 862 Series

Appropriate marking system:
Marking strips

Comb-style jumper bar; for conductor entry; insulated; terminated conductor entry; I_N 32 A

black	862-482	5
-------	---------	---

Test plug; with 500 mm cable; 2 mm Ø; max. 42 V

red	210-136	50
-----	---------	----

Marking strip; on reel; 7.5 mm wide; not stretchable; plain; snap-on type

white	709-178	1
-------	---------	---

Operating tool with a partially insulated shaft; Type 2; (3.5 x 0.5) mm blade

	210-720	1
--	---------	---

Connect Lighting and Equipment Worldwide

Contact Technology

294 Series

Contact Technology

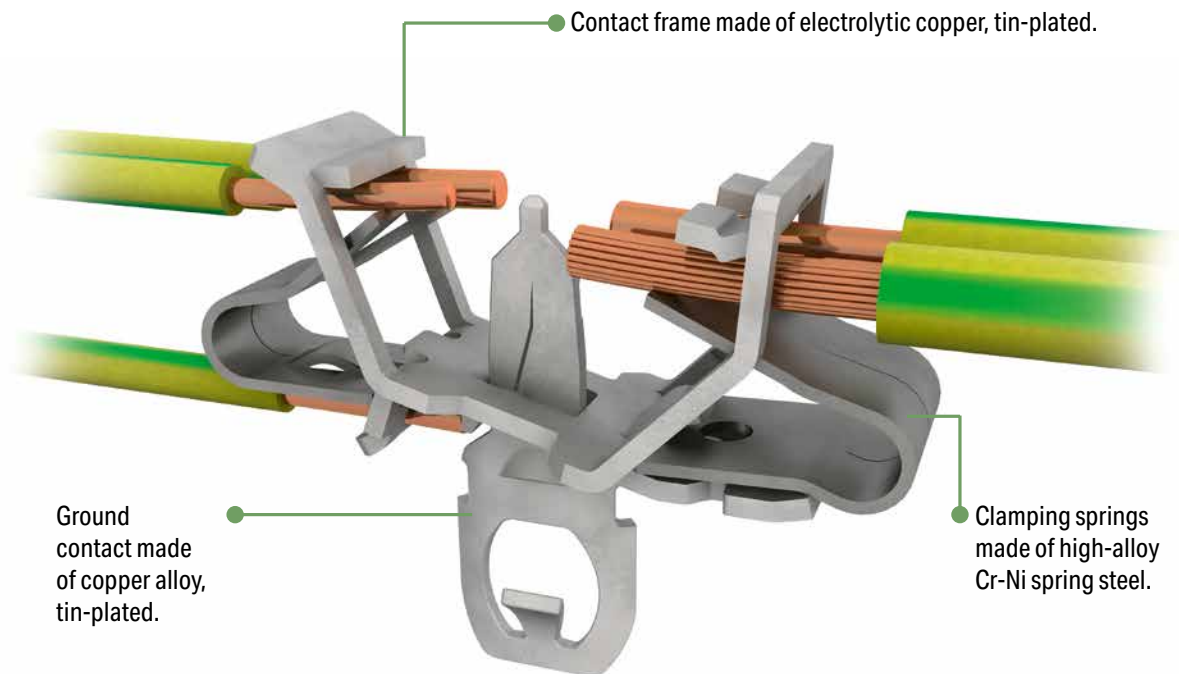

EUROPE

1 x 0.5 ... 2.5 mm² "s"

1 x 0.5 ... 1.5 mm² "s"

1 x 0.5 ... 0.75 mm² "s"

AMERICA

1 x AWG 18 ... 14 "s"

1 x AWG 18 ... 16 "s"

1 x AWG 18 "s"

JAPAN

1 x 0.8 ... 1.6 mm diam. "s"

1 x 0.8 ... 1 mm diam. "s"

1 x 0.8 mm diam. "s"

Internal connection:

PUSH WIRE® for internal wiring with solid conductors

EUROPE

2 x 0.5 ... 2.5 mm² "s, str, f-str"

AMERICA

2 x AWG 18 ... 12 "s"

2 x AWG 18 ... 14 "s, f-str"

JAPAN

2 x 0.8 ... 2 mm diam. "s"

2 x 0.5 ... 2 mm² "str, f-str"

External connection:

Push-in CAGE CLAMP® for field-wiring with all conductor types

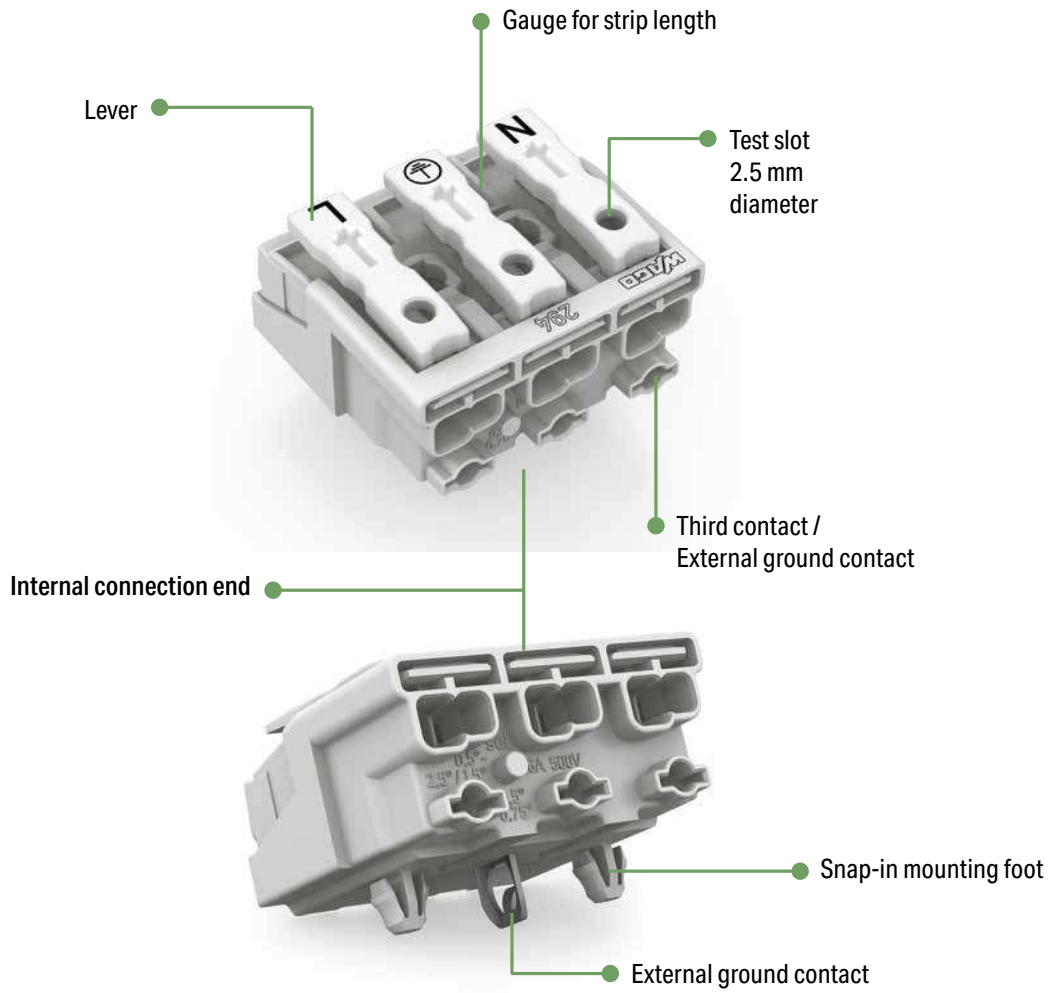

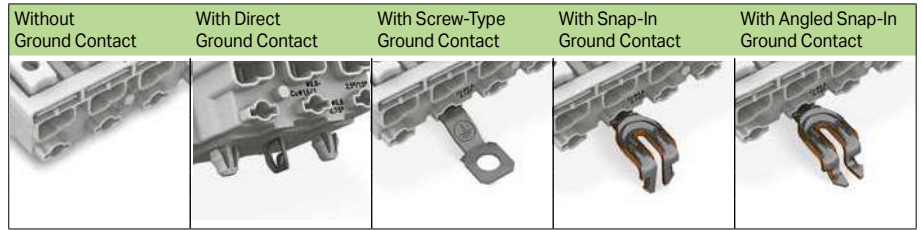
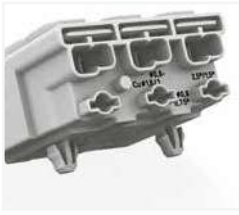

PUSH-IN CAGE CLAMP® / PUSH WIRE®

Field-Wiring Terminal Block; with Two Snap-In Mounting Feet – Overview 294 Series



Pole No.	Marking	Item No.	Item No.	Item No.	Item No.	Item No.
2 	plain	294-5002				
	N-L	294-5012				
	N`-L`	294-5022				
	DA- DA+	294-5032				
	- +	294-5072				
	1-N	294-5052				
	2-1	294-5042				

3 	plain	294-5003				
	N-PE-L	294-5013	294-5113	294-5413	294-5213	294-5313
	N`-PE-L`	294-5023	294-5123	294-5423	294-5223	294-5323
	1-PE-N	294-5053	294-5153	294-5453	294-5253	294-5353
	3-2-1	294-5043				
	N-E-L	294-5093/3025-000				

4 	plain	294-5004				
	1/L`-2/L-PE-N	294-5024	294-5124	294-5424	294-5224	294-5324
	1-2-PE-N	294-5014	294-5114	294-5414	294-5214	294-5314
	4-3-2-1	294-5044				
	1/L`-2/L E-N	294-5094/4025-000				

5 	plain	294-5005				
	L3-L2-L1-PE_N	294-5015		294-5415	294-5215	294-5315
	L`-N`-L-PE-N	294-5025		294-5425	294-5225	294-5325
	DA+ DA- L PE N	294-5035		294-5435	294-5235	294-5335
	DA- N PE L DA+	294-5075	294-5175	294-5475	294-5275	294-5375
	3-N-PE-1-2	294-5055	294-5155	294-5455	294-5255	294-5355
	5-4-3-2-1	294-5045				
	DA+ DA- L E N	294-5095/5025-000				
	L3-L2-L1-E-N	294-5095/5026-000				
	L`-N`-L-E-N	294-5095/5027-000				

10

Field-Wiring Terminal Block; without Snap-In Mounting Feet – Overview 294 Series

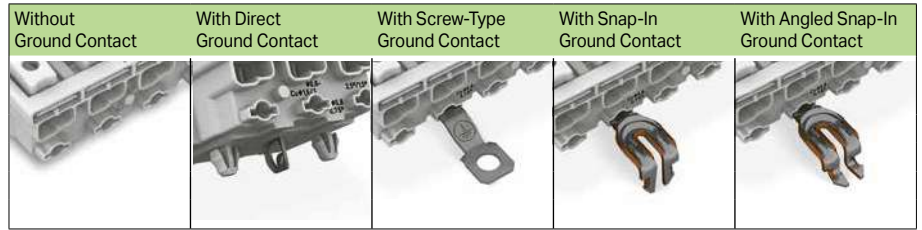



Pole No.	Marking	Item No.	Item No.	Item No.	Item No.	Item No.
2 	plain	294-4002				
	N-L	294-4012				
	N´-L´	294-4022				
	DA- DA+	294-4032				
	- +	294-4072				
	1-N	294-4052				
	2-1	294-4042				

3 	plain	294-4003				
	N-PE-L	294-4013		294-4413	294-4213	294-4313
	N´-PE-L´	294-4023		294-4423	294-4223	294-4323
	1-PE-N	294-4053		294-4453	294-4253	294-4353
	3-2-1	294-4043				
	N-E-L	294-4093/3025-000				

4 	plain	294-4004				
	1/L´-2/L-PE-N	294-4024		294-4424	294-4224	294-4324
	1-2-PE-N	294-4014		294-4414	294-4214	294-4314
	4-3-2-1	294-4044				
	1/L´-2/L E-N	294-4094/4025-000				

5 	plain	294-4005				
	L3-L2-L1-PE_N	294-4015		294-4415	294-4215	294-4315
	L´-N´-L-PE-N	294-4025		294-4425	294-4225	294-4325
	DA+ DA- L PE N	294-4035		294-4435	294-4235	294-4335
	DA- N PE L DA+	294-4075		294-4475	294-4275	294-4375
	3-N-PE-1-2	294-4055		294-4455	294-4255	294-4355
	5-4-3-2-1	294-4045				
	DA+ DA- L E N	294-4095/5025-000				
	L3-L2-L1-E-N	294-4095/5026-000				
	L´-N´-L-E-N	294-4095/5027-000				

6 	plain	294-4006				
--	-------	----------	--	--	--	--

7 	plain	294-4007				
--	-------	----------	--	--	--	--

Field-Wiring Terminal Block

2.5 mm; 294 Series



Terminating five conductors per pole – solid and fine-stranded.

- External connection of solid, stranded and fine-stranded conductors
- Universal conductor termination (AWG, metric)
- Third contact located at the bottom of internal connection end
- Strain relief plate can be retrofitted

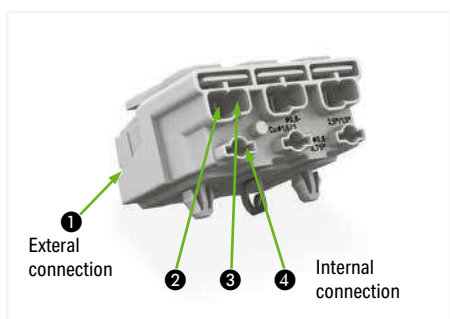

Technical Data

	IEC/EN 60998-1	IEC/EN 60998-2-2
Ratings per		
Overvoltage category	II	II
Pollution degree	2	2
Rated voltage	500 V	500 V
Rated surge voltage	4 kV	4 kV
Rated current	24 A	24 A
Temperature specification	T 85	

Conductor Data (External Connection)

Connection technology ❶	Push-in CAGE CLAMP®
Solid conductor	0.5 ... 2.5 mm / 18 ... 12 AWG
Stranded conductor	0.5 ... 2.5 mm / 18 ... 16 AWG
Fine-stranded conductor	0.5 ... 2.5 mm / 18 ... 16 AWG
Solid conductor, push-in termination	0.5 ... 2.5 mm / 18 ... 12 AWG
Fine-stranded conductor with ferrule, push-in termination	0.5 mm ² / 18 AWG
Fine-stranded conductor with ferrule with plastic collar	0.5 ... 1.5 mm / 18 ... 16 AWG
Fine-stranded conductor with ferrule without plastic collar	0.5 ... 1.5 mm / 18 ... 16 AWG

Conductor Data (Internal Connection)

Connection technology	PUSH WIRE®
Conductor termination ❷	
Solid conductor	0.5 ... 2.5 mm / 18 ... 14 AWG
Fine-stranded conductor with ferrule without plastic collar	0.5 ... 1.5 mm / 18 ... 14 AWG
Fine-stranded conductor with ferrule with plastic collar	0.5 ... 1.5 mm / 18 ... 14 AWG
Conductor termination ❸	
Solid conductor	0.5 ... 1.5 mm / 18 ... 16 AWG
Fine-stranded conductor with ferrule without plastic collar	0.5 ... 1 mm / 18 ... 14 AWG
Fine-stranded conductor with ferrule with plastic collar	0.5 ... 0.75 mm / 18 AWG
Conductor termination ❹	
Solid conductor	0.5 ... 0.75 mm / 18 AWG
Strip length	8 ... 9 mm / 0.31 ... 0.35 inch

Material Data

Material group	IIIa
Insulation material	Polycarbonate (PC)
Temperature stability	Relative Temperature Index (RTI) of 120 °C
Flammability class per UL 94	V0
Clamping spring material	Chrome nickel spring steel (CrNi)
Contact material	Electrolytic copper (E _{cu})
Contact plating	Tin-plated
16 mm-high versions are available upon request.	

Field-Wiring Terminal Block

2.5 mm; 294 Series

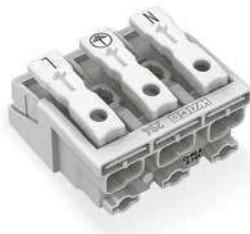

Dimensions in mm

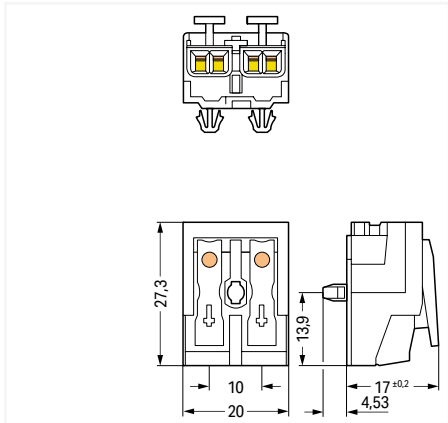

Field-wiring terminal block; without ground contact; with snap-in mounting feet; 2-pole; white

Marking	Item No.	Pack. Unit
○ N-L	294-5012	1000
○ N´-L´	294-5022	1000
○ DA- DA+	294-5032	1000
○ - +	294-5072	1000
○ 2-1	294-5042	1000
○ 1-N	294-5052	1000
○ plain	294-5002	1000

Dimensions in mm

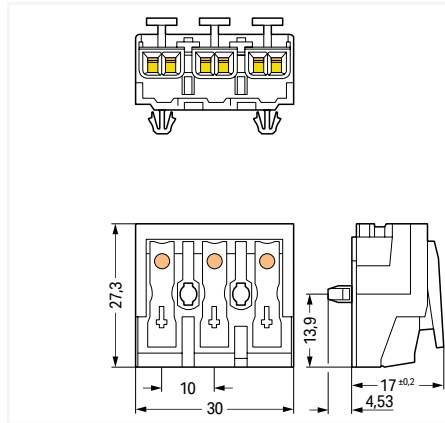

Field-wiring terminal block; without ground contact; with snap-in mounting feet; 3-pole; white

Marking	Item No.	Pack. Unit
○ N-PE-L	294-5013	500
○ N´-PE-L´	294-5023	500
○ 1-PE-N	294-5053	500
○ 3-2-1	294-5043	500
○ plain	294-5003	500
○ N-E-L	294-5093/3025-000	500

Dimensions in mm

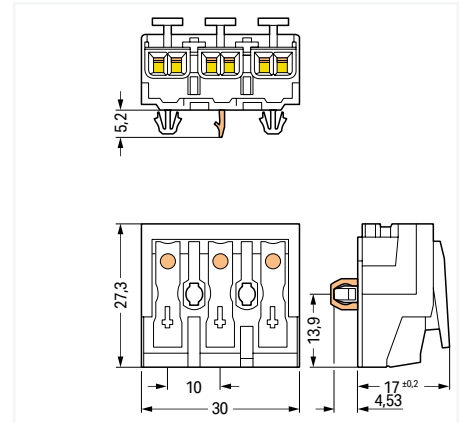

Field-wiring terminal block; with direct ground contact; with snap-in mounting feet; 3-pole; white

Marking	Item No.	Pack. Unit
○ N-PE-L	294-5113	500
○ N´-PE-L´	294-5123	500
○ 1-PE-N	294-5153	500

Field-wiring terminal block; without ground contact; without snap-in mounting feet; 2-pole; white

○ N-L	294-4012	1000
○ N´-L´	294-4022	1000
○ DA- DA+	294-4032	1000
○ - +	294-4072	1000
○ 2-1	294-4042	1000
○ 1-N	294-4052	1000
○ plain	294-4002	1000

Field-wiring terminal block; without ground contact; without snap-in mounting feet; 3-pole; white

○ N-PE-L	294-4013	500
○ N´-PE-L´	294-4023	500
○ 1-PE-N	294-4053	500
○ 3-2-1	294-4043	500
○ plain	294-4003	500
○ N-E-L	294-4093/3025-000	500

Field-Wiring Terminal Block

2.5 mm; 294 Series

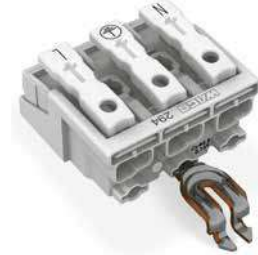
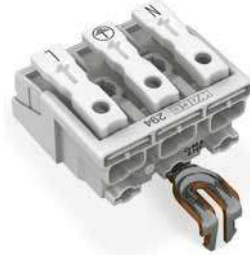
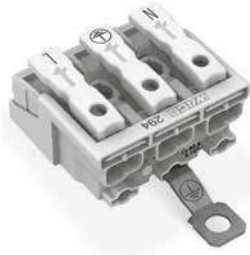

Dimensions in mm

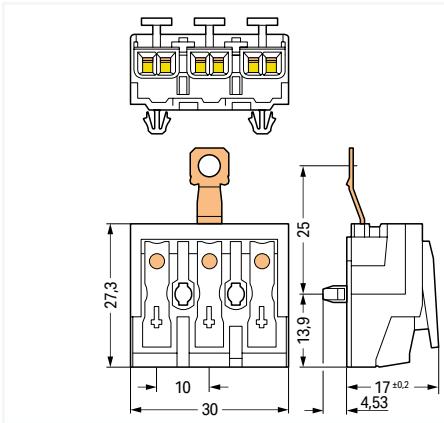

Field-wiring terminal block; with screw-type ground contact; with snap-in mounting feet; 3-pole; white

Marking	Item No.	Pack. Unit
○ N-PE-L	294-5413	500
○ N'-PE-L'	294-5423	500
○ 1-PE-N	294-5453	500

Dimensions in mm

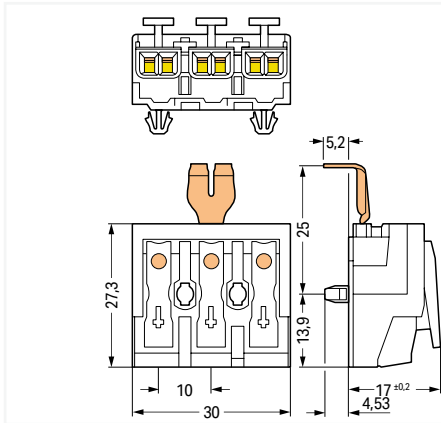

Field-wiring terminal block; with ground contact; with snap-in mounting feet; 3-pole; white

Marking	Item No.	Pack. Unit
○ N-PE-L	294-5213	500
○ N'-PE-L'	294-5223	500
○ 1-PE-N	294-5253	500

Dimensions in mm

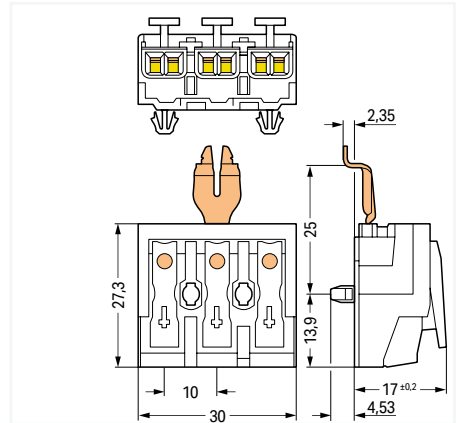

Field-wiring terminal block; with angled ground contact; with snap-in mounting feet; 3-pole; white

Marking	Item No.	Pack. Unit
○ N-PE-L	294-5313	500
○ N'-PE-L'	294-5323	500
○ 1-PE-N	294-5353	500

Field-wiring terminal block; with screw-type ground contact; without snap-in mounting feet; 3-pole; white

○ N-PE-L	294-4413	500
○ N'-PE-L'	294-4423	500
○ 1-PE-N	294-4453	500

Field-wiring terminal block; with snap-in ground contact; without snap-in mounting feet; 3-pole; white

○ N-PE-L	294-4213	500
○ N'-PE-L'	294-4223	500
○ 1-PE-N	294-4253	500

Field-wiring terminal block; with angled snap-in ground contact; without snap-in mounting feet; 3-pole; white

○ N-PE-L	294-4313	500
○ N'-PE-L'	294-4323	500
○ 1-PE-N	294-4353	500

10

PUSH-IN CAGE CLAMP® | **PUSH WIRE®**

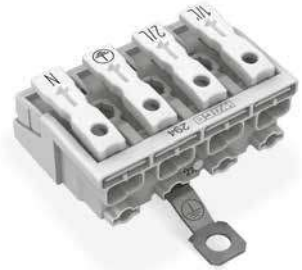
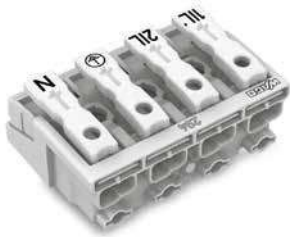

Dimensions in mm

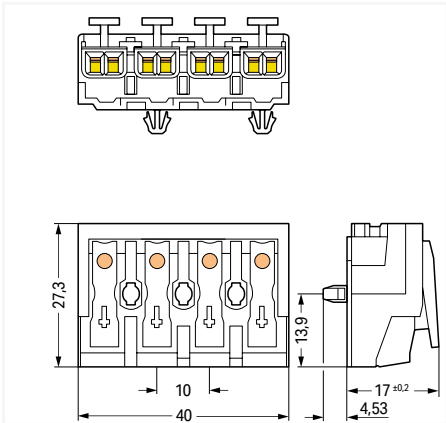

Field-wiring terminal block; without ground contact; with snap-in mounting feet; 4-pole; white

Marking	Item No.	Pack. Unit
○ 1/L'-2/L-PE-N	294-5024	500
○ 1-2-PE-N	294-5014	500
○ 4-3-2-1	294-5044	500
○ plain	294-5004	500
○ 1/L'-2/L-E-N	294-5094/4025-000	500

Dimensions in mm

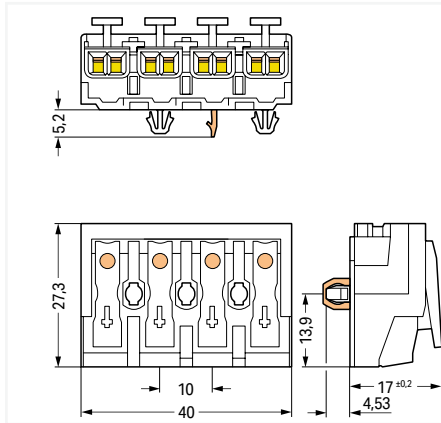

Field-wiring terminal block; with direct ground contact; with snap-in mounting feet; 4-pole; white

Marking	Item No.	Pack. Unit
○ 1/L'-2/L-PE-N	294-5124	500
○ 1-2-PE-N	294-5114	500

Dimensions in mm

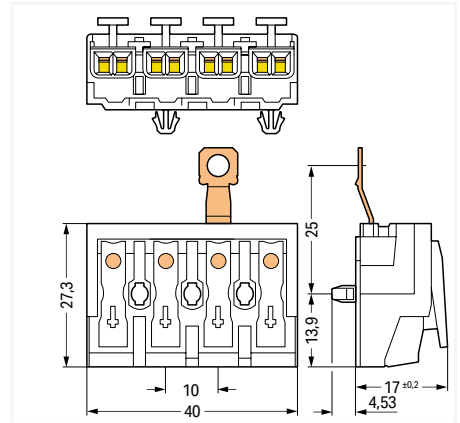

Field-wiring terminal block; with screw-type ground contact; with snap-in mounting feet; 4-pole; white

Marking	Item No.	Pack. Unit
○ 1/L'-2/L-PE-N	294-5424	500
○ 1-2-PE-N	294-5414	500

Field-wiring terminal block; without ground contact; without snap-in mounting feet; 4-pole; white

○ 1/L'-2/L-PE-N	294-4024	500
○ 1-2-PE-N	294-4014	500
○ 4-3-2-1	294-4044	500
○ plain	294-4004	500
○ 1/L'-2/L-E-N	294-4094/4025-000	500

Field-wiring terminal block; with screw-type ground contact; without snap-in mounting feet; 4-pole; white

○ 1/L'-2/L-PE-N	294-4424	500
○ 1-2-PE-N	294-4414	500

Field-Wiring Terminal Block

2.5 mm; 294 Series

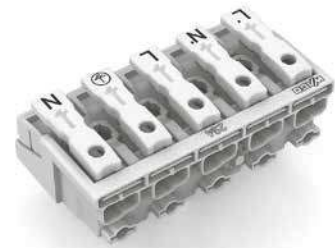
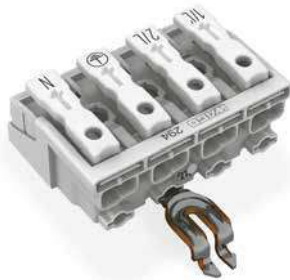
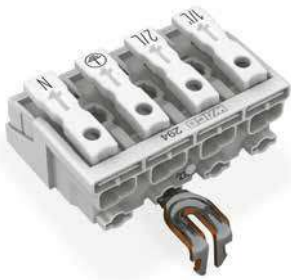

Dimensions in mm

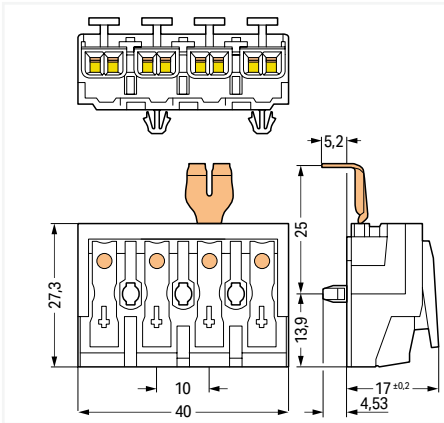

Field-wiring terminal block; with ground contact; with snap-in mounting feet; 4-pole; white

Marking	Item No.	Pack. Unit
○ 1/L'-2/L-PE-N	294-5224	500
○ 1-2-PE-N	294-5214	500

Dimensions in mm

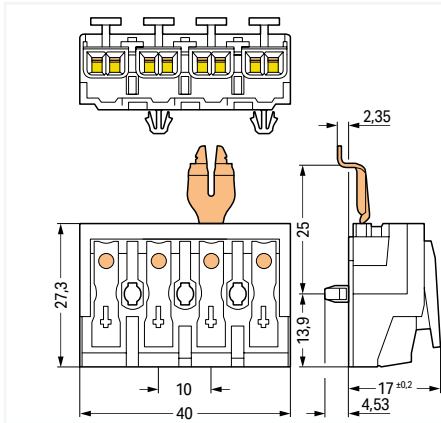

Field-wiring terminal block; with angled ground contact; with snap-in mounting feet; 4-pole; white

Marking	Item No.	Pack. Unit
○ 1/L'-2/L-PE-N	294-5324	500
○ 1-2-PE-N	294-5314	500

Dimensions in mm

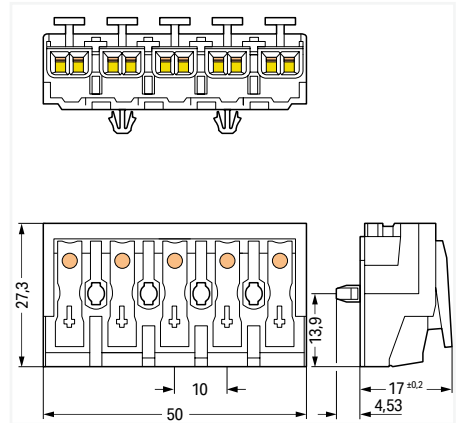

Field-wiring terminal block; without ground contact; with snap-in mounting feet; 5-pole; white

Marking	Item No.	Pack. Unit
○ L'-N'-L-PE-N	294-5025	250
○ L3-L2-L1-PE-N	294-5015	250
○ DA+ DA- L PE N	294-5035	250
○ DA- N PE L DA+	294-5075	250
○ 3-N-PE-1-2	294-5055	250
○ 5-4-3-2-1	294-5045	250
○ plain	294-5005	250
○ DA+ DA- L E N	294-5095/5025-000	250
○ L3-L2-L1-E-N	294-5095/5026-000	250
○ L'-N'-L-E-N	294-5095/5027-000	250

10

Field-wiring terminal block; with snap-in ground contact; without snap-in mounting feet; 4-pole; white

○ 1/L'-2/L-PE-N	294-4224	500
○ 1-2-PE-N	294-4214	500

Field-wiring terminal block; with angled snap-in ground contact; without snap-in mounting feet; 4-pole; white

○ 1/L'-2/L-PE-N	294-4324	500
○ 1-2-PE-N	294-4314	500

Field-wiring terminal block; without ground contact; without snap-in mounting feet; 5-pole; white

○ L'-N'-L-PE-N	294-4025	250
○ L3-L2-L1-PE-N	294-4015	250
○ DA+ DA- L PE N	294-4035	250
○ DA- N PE L DA+	294-4075	250
○ 3-N-PE-1-2	294-4055	250
○ 5-4-3-2-1	294-4045	250
○ plain	294-4005	250
○ DA+ DA- L E N	294-4095/5025-000	250
○ L3-L2-L1-E-N	294-4095/5026-000	250
○ L'-N'-L-E-N	294-4095/5027-000	250

PUSH-IN CAGE CLAMP® | **PUSH WIRE®**



Dimensions in mm

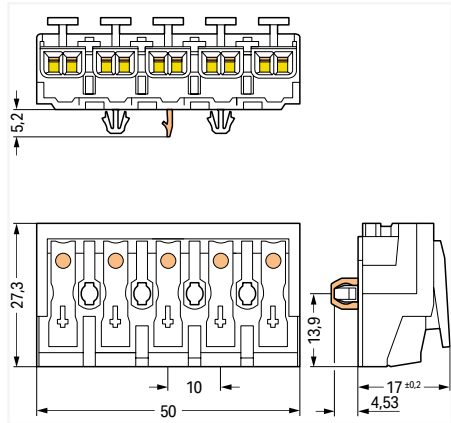

Field-wiring terminal block; with direct ground contact; with snap-in mounting feet; 5-pole; white

Marking	Item No.	Pack. Unit
○ DA- N PE L DA+	294-5175	250
○ 3-N-PE-1-2	294-5155	250

Dimensions in mm

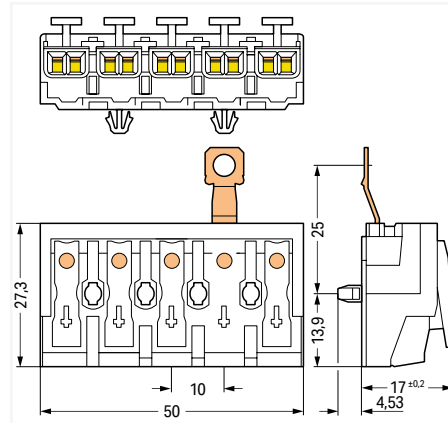

Field-wiring terminal block; with screw-type ground contact; with snap-in mounting feet; 5-pole; white

Marking	Item No.	Pack. Unit
○ L'-N'-L-PE-N	294-5425	250
○ L3-L2-L1-PE-N	294-5415	250
○ DA+ DA- L PE N	294-5435	250
○ DA- N PE L DA+	294-5475	250
○ 3-N-PE-1-2	294-5455	250

Dimensions in mm

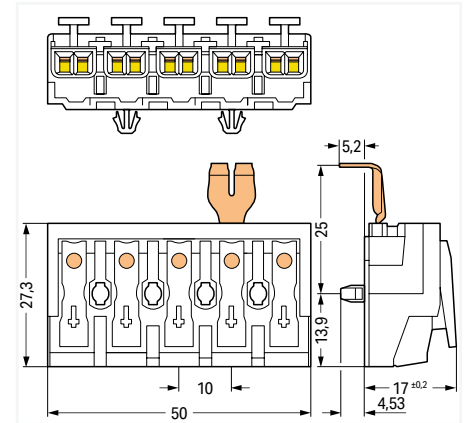

Field-wiring terminal block; with ground contact; with snap-in mounting feet; 5-pole; white

Marking	Item No.	Pack. Unit
○ L'-N'-L-PE-N	294-5225	250
○ L3-L2-L1-PE-N	294-5215	250
○ DA+ DA- L PE N	294-5235	250
○ DA- N PE L DA+	294-5275	250
○ 3-N-PE-1-2	294-5255	250

Field-wiring terminal block; with screw-type ground contact; without snap-in mounting feet; 5-pole; white

○ L'-N'-L-PE-N	294-4425	250
○ L3-L2-L1-PE-N	294-4415	250
○ DA+ DA- L PE N	294-4435	250
○ DA- N PE L DA+	294-4475	250
○ 3-N-PE-1-2	294-4455	250

Field-wiring terminal block; with snap-in ground contact; without snap-in mounting feet; 5-pole; white

○ L'-N'-L-PE-N	294-4225	250
○ L3-L2-L1-PE-N	294-4215	250
○ DA+ DA- L PE N	294-4235	250
○ DA- N PE L DA+	294-4275	250
○ 3-N-PE-1-2	294-4255	250

Field-Wiring Terminal Block

2.5 mm; 294 Series

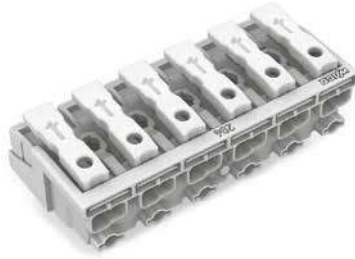
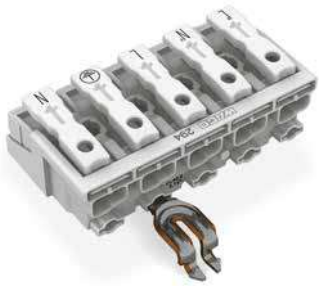

Dimensions in mm

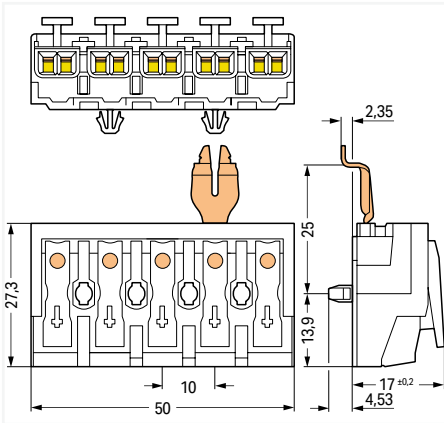

Field-wiring terminal block; without ground contact; with snap-in mounting feet; 5-pole; white

Marking	Item No.	Pack. Unit
○ L'-N'-L-PE-N	294-5325	250
○ L3-L2-L1-PE-N	294-5315	250
○ DA+ DA- L PE N	294-5335	250
○ DA- N PE L DA+	294-5375	250
○ 3-N-PE-1-2	294-5355	250

Dimensions in mm

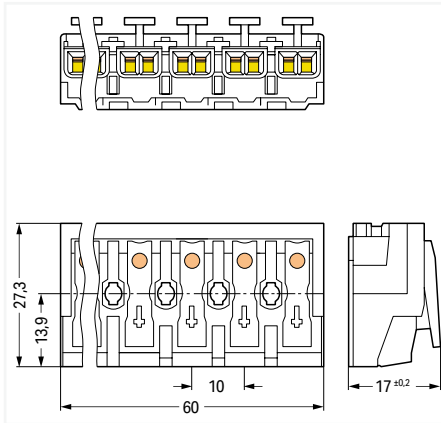

Field-wiring terminal block; without ground contact; without snap-in mounting feet; 6-pole; white

Marking	Item No.	Pack. Unit
○ plain	294-4006	200

Dimensions in mm

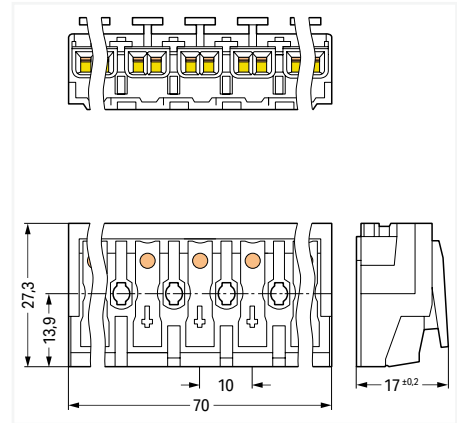

Field-wiring terminal block; without ground contact; without snap-in mounting feet; 7-pole; white

Marking	Item No.	Pack. Unit
○ plain	294-4007	200

Field-wiring terminal block; without ground contact; without snap-in mounting feet; 5-pole; white

Marking	Item No.	Pack. Unit
○ L'-N'-L-PE-N	294-4325	250
○ L3-L2-L1-PE-N	294-4315	250
○ DA+ DA- L PE N	294-4335	250
○ DA- N PE L DA+	294-4375	250
○ 3-N-PE-1-2	294-4355	250

10

Tool and Strain Relief Plate

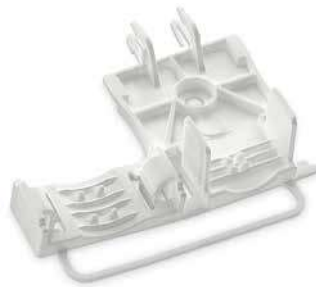

Dimensions in mm

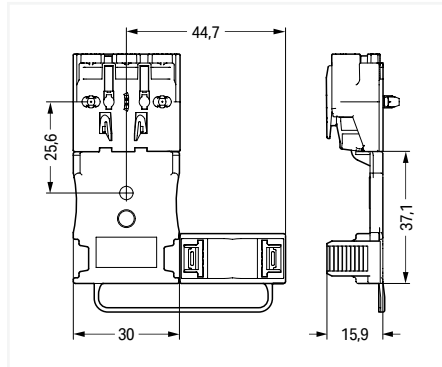

Dimensions in mm

Disconnection tool; removes conductors from PUSH WIRE® connections

Item No.	Pack. Unit
206-294	1

Strain relief plate; with locking clip; for multicore cable: 1 x 5.2 ... 12 mm outer diameter

Marking	Item No.	Pack. Unit
○ white	294-364	50

Strain relief; with snap-in mounting feet; for 4.5 ... 12 mm cable diameter

Marking	Item No.	Pack. Unit
○ white	294-370	500

Strain relief plate; with locking clip; for flat cables and individual conductors: min. 3 x 0.5 mm², max. 5 x 2.5 mm² or 7 x 1.5 mm²

Marking	Item No.	Pack. Unit
○ white	294-384	50

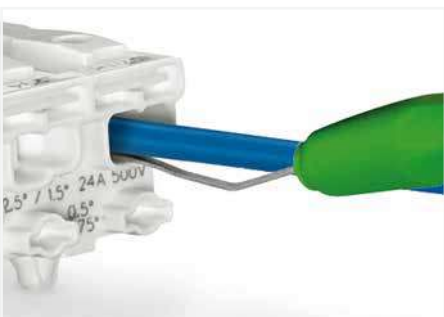

Conductor removal:
Slide disconnection tool beneath the conductor and pull both conductor and tool out.



Strain relief; for screw/rivet mounting; for 4.5 ... 12 mm cable diameter

Marking	Item No.	Pack. Unit
○ white	294-375	500

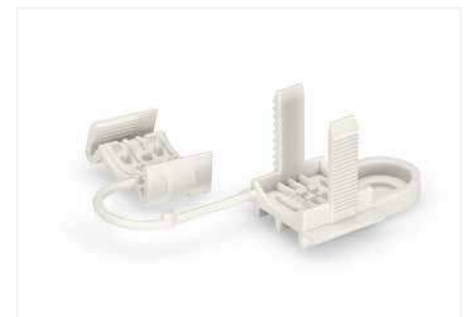

Strain relief; for screw/rivet mounting; for 4.5 ... 12 mm cable diameter

10

Drilled-Hole Patterns for Snap-In Mounting Feet 294 Series

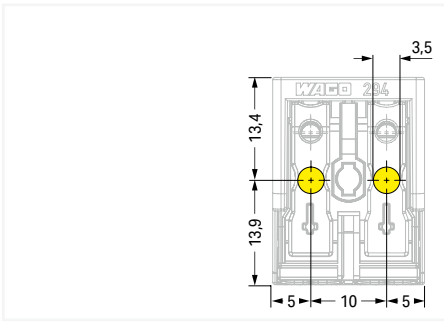

2-pole – without ground contact

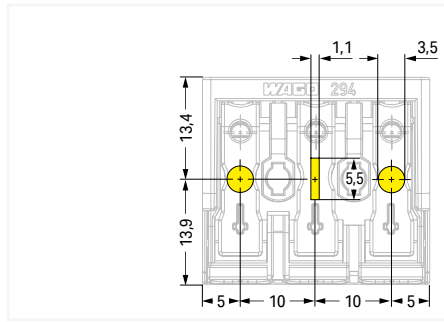

3-pole – with direct ground contact

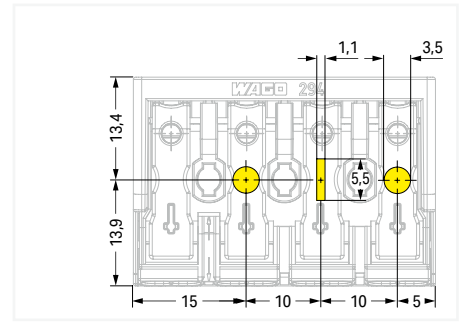

3-pole – with direct ground contact

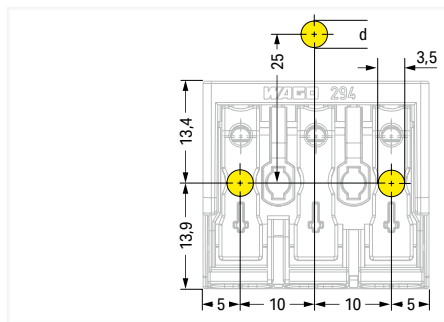

3-pole –
with snap-in ground contact, $d = 4.9 \text{ mm}$
with screw-type ground contact, $d \leq 4.1 \text{ mm}$

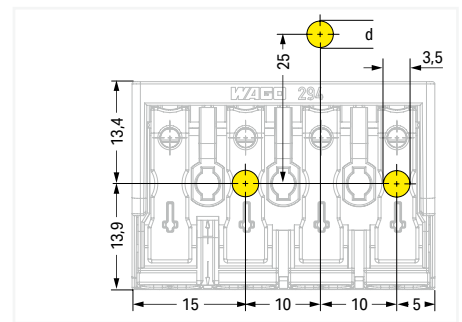

4-pole –
with snap-in ground contact, $d = 4.9 \text{ mm}$
with screw-type ground contact, $d \leq 4.1 \text{ mm}$

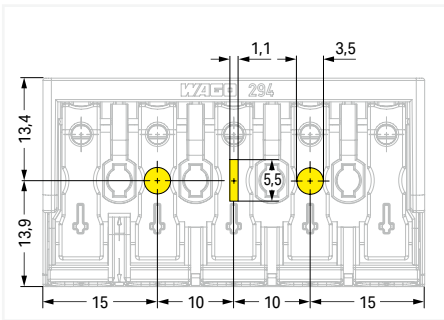

3-pole – with direct ground contact

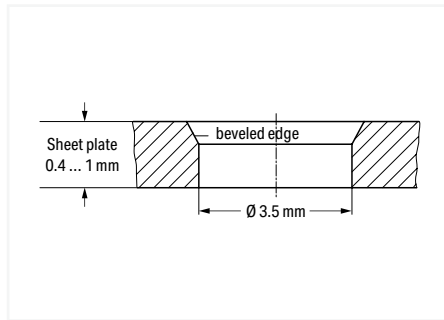

Drilled hole for snap-in mounting foot

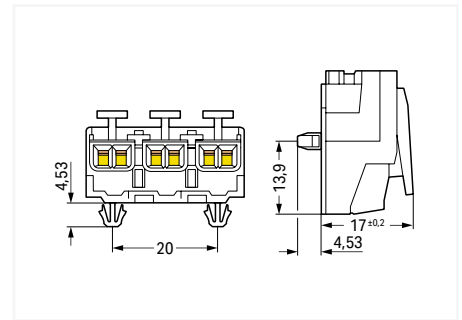

Snap-in mounting foot

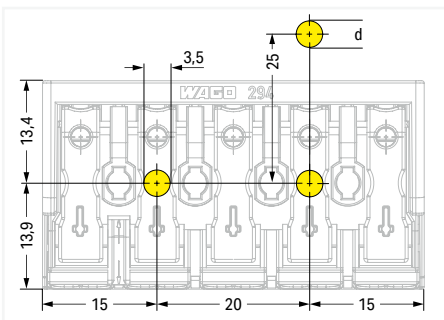

5-pole –
with snap-in ground contact, $d = 4.9 \text{ mm}$
with screw-type ground contact, $d \leq 4.1 \text{ mm}$

10

Drilled-Hole Patterns for Screw Mounting

294 Series

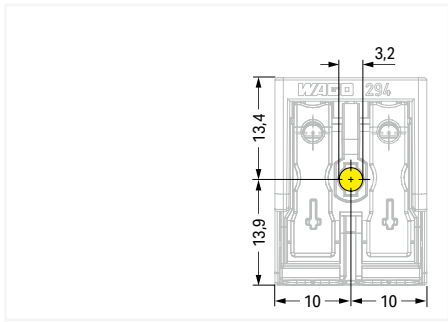

2-pole – without ground contact

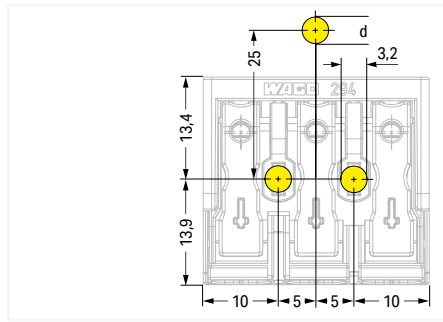

3-pole –
with snap-in ground contact, $d = 4.9 \text{ mm}$
with screw-type ground contact, $d \leq 4.1 \text{ mm}$

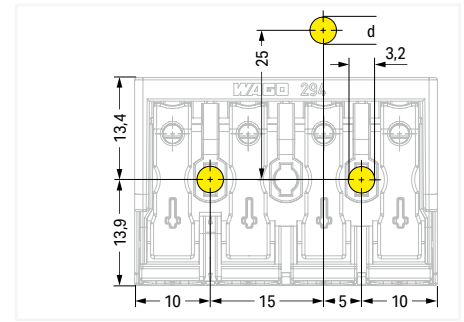

4-pole –
with snap-in ground contact, $d = 4.9 \text{ mm}$
with screw-type ground contact, $d \leq 4.1 \text{ mm}$

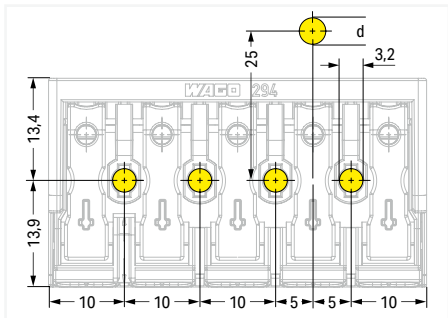

5-pole –
with snap-in ground contact, $d = 4.9 \text{ mm}$
with screw-type ground contact, $d \leq 4.1 \text{ mm}$

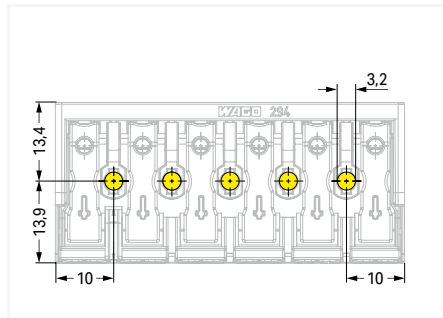

6-pole – without ground contact

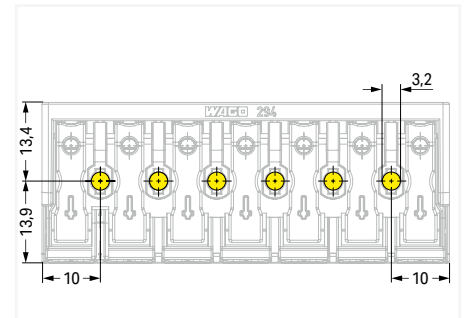

7-pole – without ground contact

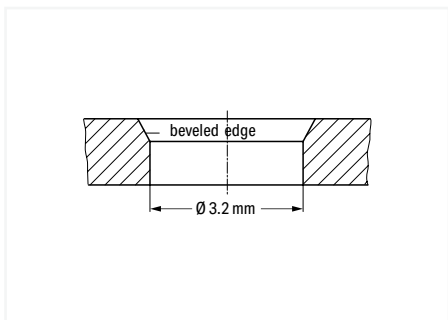

Hole for screw mount
Notice:
The maximum thread diameter for self-tapping screws is 3 mm.

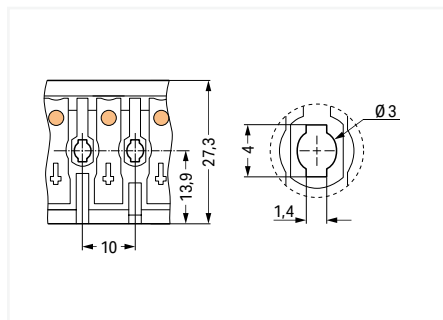

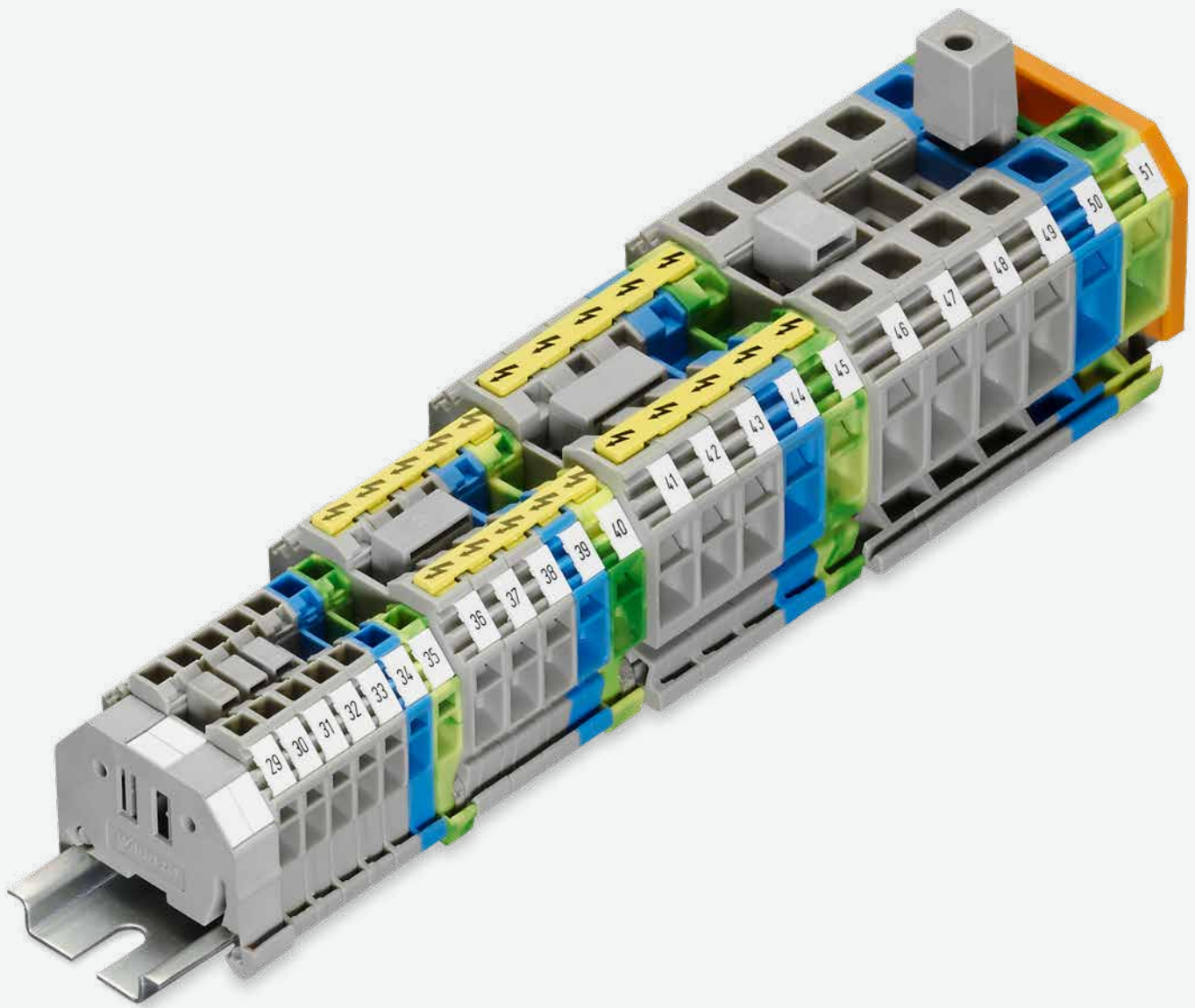

Mounting hole for screw
Notice:
The maximum thread diameter for self-tapping screws is 3 mm.



WAGO Rail-Mount Terminal Blocks Classic

WAGO Rail-Mount Terminal Blocks Classic

Side-Entry Wiring

			Page
	Through and Ground Conductor Terminal Blocks 0.08 ... 16 mm ² (28 ... 6 AWG)	279 ... 283 Series	580
	Disconnect/Test Terminal Blocks and Ground Conductor Disconnect Terminal Blocks 0.2 ... 6 mm ² (24 ... 10 AWG)	282 Series	584
	Fuse Terminal Blocks 0.2 ... 6 mm ² (24 ... 10 AWG)	282 Series	586

Rail-Mount Terminal Blocks Classic; Side-Entry Wiring 279 ... 284 Series Description and Installation



Snapping side-entry rail-mount terminal blocks onto the DIN-rail.

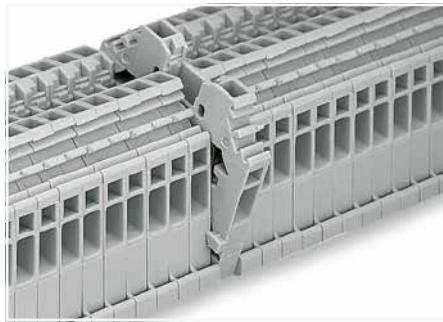

Quick assembly keys prevent reverse mounting.

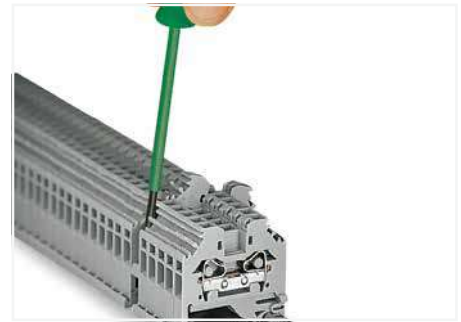

Removing a terminal block from the assembly.



CAGE CLAMP® connection
Inserting a conductor.
With ferruled conductors, it is necessary to use a terminal block one size larger than the conductor's nominal cross section.

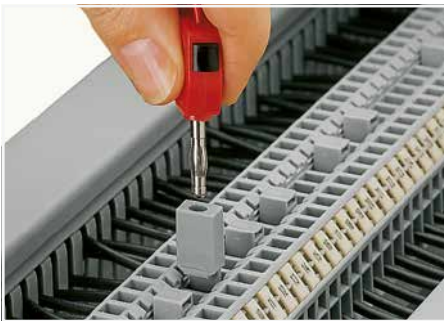

Testing with a test plug –
Picture shows a test plug adapter (209-170).

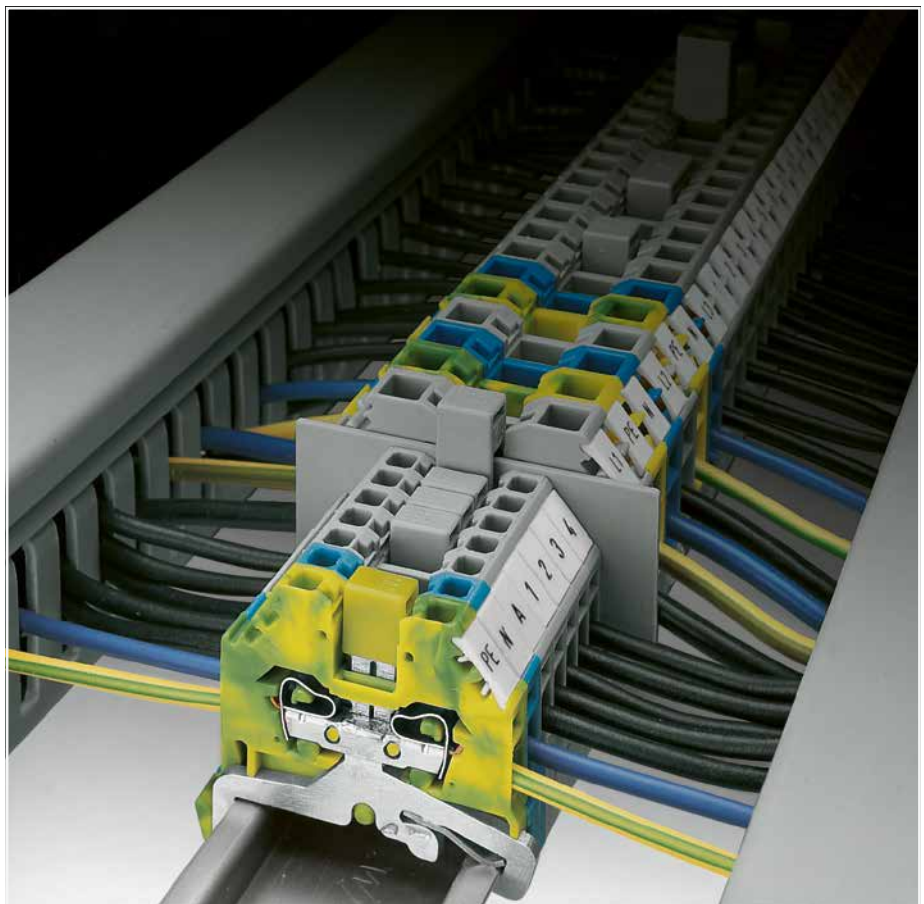

11



Commoning using an adjacent jumper (280-402).
Push jumpers down until fully inserted.



Commoning side-entry rail-mount terminal blocks via step-down jumpers.
Push down the step-down jumper until fully inserted.



CAGE CLAMP® terminates the following copper conductors:
solid "s"



stranded "st"



fine-stranded "f-st",
also with tinned
single strands



Suitable for all DIN-35 rails

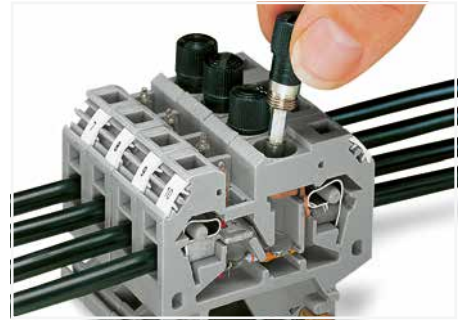

Replacing a fuse.

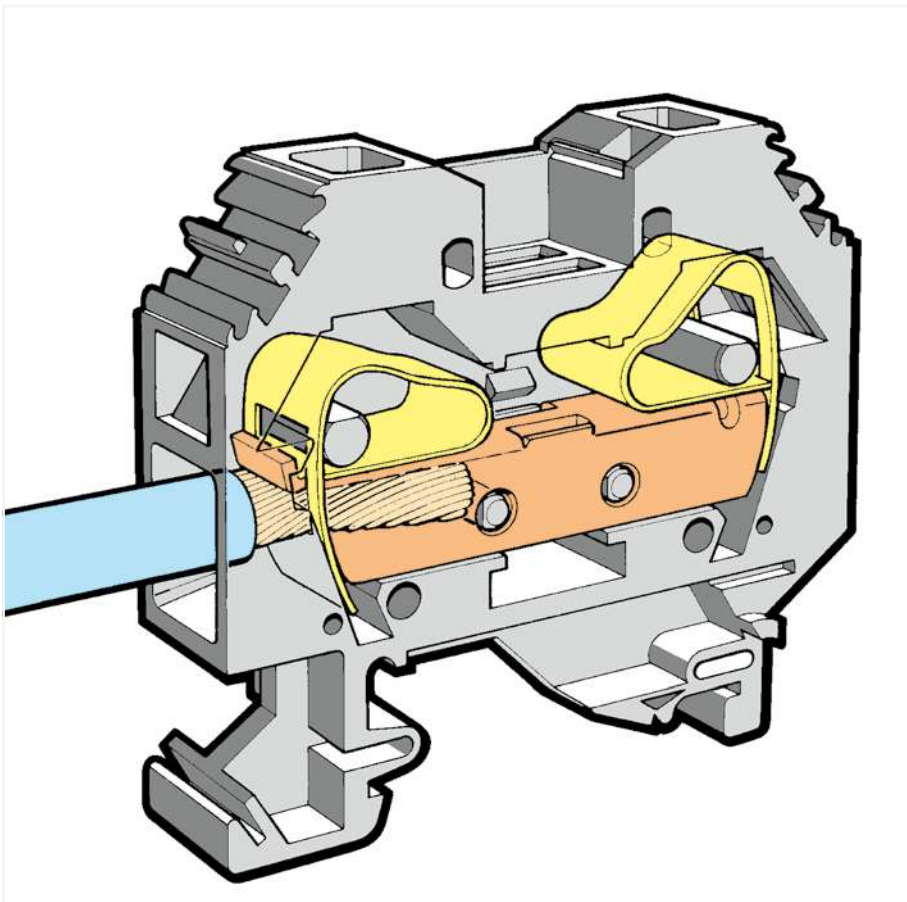

Shifting the disconnect slide link of a disconnect/test terminal block.

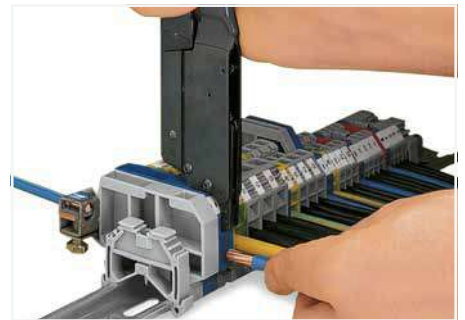

When operating the handles beyond the locked position, the ratchet allows the tool to open and be removed from the terminal block.



Labeling via WMB Multi Marking System.



fine-stranded, tip-bonded



fine-stranded, with ferrule (gastight crimped)



fine-stranded, with pin terminal (gastight crimped)

Through and Ground Conductor Terminal Block

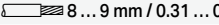

1.5 mm²; 279 Series and 2.5 mm²; 280 Series and 4 mm²; 281 Series and 6 mm²; 282 Series

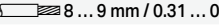

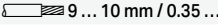
Technical Data	
0.08 ... 1.5 mm ²	28 ... 16 AWG
800 V / 8 kV / 3 ⚡	600 V, 10 A ⚡
I _N 18 A	600 V, 15 A Ⓜ
Terminal block width: 4 mm / 0.157 inch	
 8 ... 9 mm / 0.31 ... 0.35 inch	

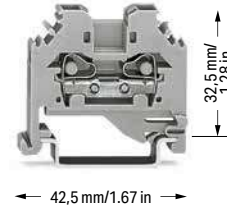
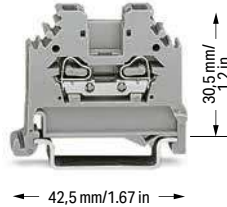
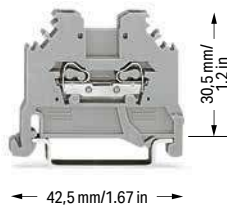

Technical Data	
0.08 ... 2.5 mm ²	28 ... 12 AWG*
800 V / 8 kV / 3 ⚡	600 V, 20 A ⚡
I _N 24 A	600 V, 20 A Ⓜ
Terminal block width: 5 mm / 0.197 inch	
 8 ... 9 mm / 0.31 ... 0.35 inch	

Technical Data	
0.08 ... 4 mm ²	28 ... 12 AWG
800 V / 8 kV / 3 ⚡	600 V, 20 A ⚡
I _N 32 A	600 V, 25 A Ⓜ
Terminal block width: 6 mm / 0.236 inch	
 9 ... 10 mm / 0.35 ... 0.39 inch	





2-conductor through terminal block		
Color	Item No.	Pack. Unit
 gray	279-101	100
 blue	279-104 Ⓜ	100

2-conductor through terminal block		
Color	Item No.	Pack. Unit
 gray	280-101	100
 blue	280-104 Ⓜ	100

2-conductor through terminal block		
Color	Item No.	Pack. Unit
 gray	281-101	100
 blue	281-104 Ⓜ	100



2-conductor ground terminal block		
Color	Item No.	Pack. Unit
 green-yellow	280-107	100



2-conductor ground terminal block		
Color	Item No.	Pack. Unit
 green-yellow	281-107	100



2-conductor ground terminal block		
Color	Item No.	Pack. Unit
 green-yellow	281-107	100



Accessories; item-specific			
End and intermediate plate; 2.5 mm thick			
Color	Item No.	Item No.	Pack. Unit
 orange	280-302	280-301	100 (25)
 gray	280-301	280-301	100 (25)



Accessories; item-specific			
End and intermediate plate; 2.5 mm thick			
Color	Item No.	Item No.	Pack. Unit
 orange	280-302	280-301	100 (25)
 gray	280-301	280-301	100 (25)



Accessories; item-specific			
End and intermediate plate; 3 mm thick			
Color	Item No.	Item No.	Pack. Unit
 orange	281-302	281-301	100 (25)
 gray	281-301	281-301	100 (25)



Separator; oversized; 2 mm thick			
Color	Item No.	Item No.	Pack. Unit
 orange	280-322	280-332	100 (25)
 gray	280-332	280-332	100 (25)

Separator; oversized; 2 mm thick			
Color	Item No.	Item No.	Pack. Unit
 orange	280-322	280-332	100 (25)
 gray	280-332	280-332	100 (25)

Separator; oversized; 2 mm thick			
Color	Item No.	Item No.	Pack. Unit
 orange	281-322	281-332	100 (25)
 gray	281-332	281-332	100 (25)

Adjacent jumper; insulated; I _N 15 A			
Color	Item No.	Item No.	Pack. Unit
 gray	279-402	279-422	200 (25)
 yellow-green	279-422	279-422	200 (25)

Adjacent jumper; insulated; I _N = I _N terminal block			
Color	Item No.	Item No.	Pack. Unit
 gray	280-402	280-422	200 (25)
 yellow-green	280-422	280-422	200 (25)

Adjacent jumper; insulated; I _N = I _N terminal block			
Color	Item No.	Item No.	Pack. Unit
 gray	281-402	281-422	200 (25)
 yellow-green	281-422	281-422	200 (25)

Alternate jumper; insulated; I _N 15 A			
Color	Item No.	Item No.	Pack. Unit
 gray	279-409	279-409	100 (25)

Alternate jumper; insulated; I _N = I _N terminal block			
Color	Item No.	Item No.	Pack. Unit
 gray	280-409	280-409	100 (25)

Alternate jumper; insulated; I _N = I _N terminal block			
Color	Item No.	Item No.	Pack. Unit
 gray	281-409	281-409	100 (25)

Step-down jumper; insulated; commons 10/6 mm ² (8/10 AWG) down to 4/2.5/1.5 mm ² (12/14/16 AWG); I _N 15 A			
Color	Item No.	Item No.	Pack. Unit
 gray	284-414	284-414	50 (25)

Step-down jumper; insulated; commons 10/6 mm ² (8/10 AWG) down to 4/2.5/1.5 mm ² (12/14/16 AWG); I _N 15 A			
Color	Item No.	Item No.	Pack. Unit
 gray	284-414	284-414	50 (25)

Step-down jumper; insulated; commons 10/6 mm ² (8/10 AWG) down to 4/2.5/1.5 mm ² (12/14/16 AWG); I _N 15 A			
Color	Item No.	Item No.	Pack. Unit
 gray	284-414	284-414	50 (25)

Step-down intermediate plate; 1 mm thick; only for 4, 2.5 and 1.5 mm ² terminal blocks			
Color	Item No.	Item No.	Pack. Unit
 gray	281-333	281-333	100 (25)

Step-down intermediate plate; 1 mm thick; only for 4, 2.5 and 1.5 mm ² terminal blocks			
Color	Item No.	Item No.	Pack. Unit
 gray	281-333	281-333	100 (25)

Step-down intermediate plate; 1 mm thick; only for 4, 2.5 and 1.5 mm ² terminal blocks			
Color	Item No.	Item No.	Pack. Unit
 gray	281-333	281-333	100 (25)

Protective warning marker; with black high-voltage symbol; for 5 terminal blocks			
Color	Item No.	Item No.	Pack. Unit
 yellow	279-405	279-405	100 (25)

Protective warning marker; with black high-voltage symbol; for 5 terminal blocks			
Color	Item No.	Item No.	Pack. Unit
 yellow	280-405	280-405	100 (25)

Step-down jumper; insulated; commons 10/6 mm ² (8/10 AWG) down to 6/4 mm ² (10/12 AWG); I _N 30 A			
Color	Item No.	Item No.	Pack. Unit
 gray	284-413	284-413	50 (25)

Test plug adapter; 8.3 mm wide; for 4 mm Ø test plug; for 1.5 ... 10 mm ² terminal blocks			
Color	Item No.	Item No.	Pack. Unit
 gray	209-170	209-170	50 (25)

Test plug adapter; 8.3 mm wide; for 4 mm Ø test plug; for 1.5 ... 10 mm ² terminal blocks			
Color	Item No.	Item No.	Pack. Unit
 gray	209-170	209-170	50 (25)

Step-down jumper; insulated; commons 16 mm ² (6 AWG) down to 4 mm ² (12 AWG); I _N 32 A			
Color	Item No.	Item No.	Pack. Unit
 gray	283-414	283-414	50 (25)

Test plug adapter; 5 mm wide; for 210-137 Test Plug (2.3 mm Ø); for 1.5 ... 4 mm ² terminal blocks			
Color	Item No.	Item No.	Pack. Unit
 gray	280-404	280-404	100 (25)

Test plug adapter; 5 mm wide; for 210-137 Test Plug (2.3 mm Ø); for 1.5 ... 4 mm ² terminal blocks			
Color	Item No.	Item No.	Pack. Unit
 gray	280-404	280-404	100 (25)

Protective warning marker; with black high-voltage symbol; for 5 terminal blocks			
Color	Item No.	Item No.	Pack. Unit
 yellow	281-405	281-405	100 (25)

11

Technical Data

0.2 ... 6 mm ²	24 ... 10 AWG
800 V / 8 kV / 3 ①	600 V, 30 A ②
I _N 41 A	600 V, 10 A ③
Terminal block width: 8 mm / 0.315 inch	
12 ... 13 mm / 0.47 ... 0.51 inch	

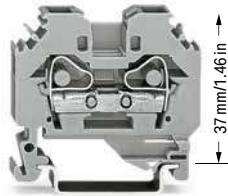

← 46,5 mm / 1.83 in →

↑ 37 mm / 1.46 in ↓

2-conductor through terminal block

Color	Item No.	Pack. Unit
gray	282-101	50
blue	282-104 ②	50

2-conductor ground terminal block



green-yellow	282-107	50
--------------	---------	----

Accessories; item-specific



End and intermediate plate; 4 mm thick

	orange	282-302	100 (25)
	gray	282-301	100 (25)

Separator; oversized; 2 mm thick

	orange	282-322	100 (25)
	gray	282-332	100 (25)

Adjacent jumper; insulated; I_N 41 A

	gray	282-402	100 (25)
	yellow-green	282-422	100 (25)

Alternate jumper; insulated; I_N 41 A

	gray	282-409	100 (25)
---	------	---------	----------

Step-down jumper; insulated; commons 10/6 mm² (8/10 AWG) down to 6/4 mm² (10/12 AWG); I_N 30 A

	gray	284-413	50 (25)
---	------	---------	---------

Step-down cover plate; 1 mm thick

	gray	284-333	100 (25)
	orange	284-343	100 (25)

Protective warning marker; with black high-voltage symbol; for 5 terminal blocks

	yellow	282-405	100 (25)
---	--------	---------	----------

Test plug adapter; 8.3 mm wide; for 4 mm Ø test plug; for 1.5 ... 10 mm² terminal blocks

	gray	209-170	50 (25)
---	------	---------	---------

B-type test plug module; snaps together; 8 mm wide

	gray	709-310	100 (25)
---	------	---------	----------

*12 AWG: THHN, THWN

- 800 V = rated voltage
8 kV = rated impulse voltage
3 = pollution degree
(see Section 15)

- Terminal blocks with a blue insulated housing are suitable for Ex i applications.

See application notes for:
Step-down jumper, page 541
Test plug module, page 381
Marking, from page 640

Approvals and corresponding ratings,
visit www.wago.com

DIN-Rail	Item No.	Current [A]	Acc. to mm ² /AWG Cu
DIN 35 x 7.5 (steel)			
slotted	210-112	76	16/6
unslotted	210-113	76	16/6
DIN 35 x 15 (steel)			
1.5 mm thick	210-114	125	35/2
2.3 mm thick	210-118	125	35/2
DIN 35 x 7.5 (Al)			
unslotted	210-196	76	16/6
DIN 35 x 15 (Cu)			
2.3 mm thick	210-198	309	150/6/0
Current applies to rails of 1 m/3'3" length			

When using standard DIN-rails as ground conductor bus-bars, please refer to the maximum current capacities listed above.

Steel DIN-rails are not suited for PEN (ground and N-conductor) applications per EN 60947-7-2 (VDE 0611, Part 3).

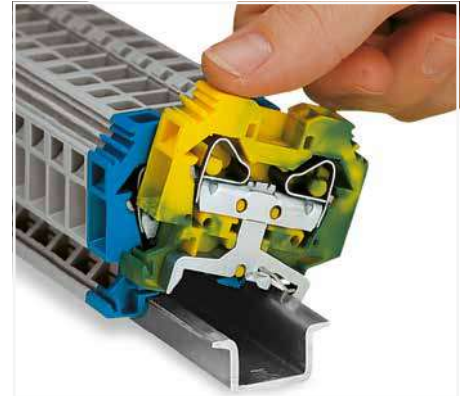

Snapping a terminal block onto the DIN-rail. Ground conductor terminal blocks snap onto the rail in the same way as through terminal blocks, but automatically make a direct electrical connection to the rail. After mounting, sliding the blocks on the rail is not possible.

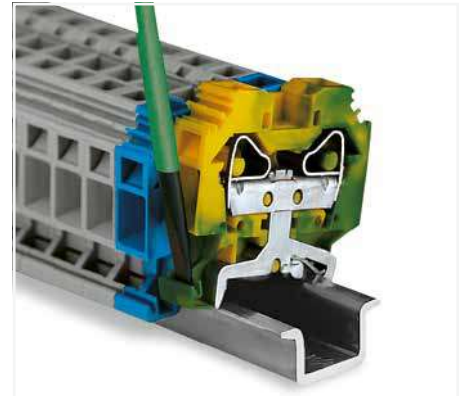

Removing a terminal block from the DIN-rail. When mounting on the rail, ensure that open sides of terminal blocks face in the same direction. Both mounting feet and removal slots are on the same side for all terminal blocks, making it possible to visually ensure blocks are facing in same direction.

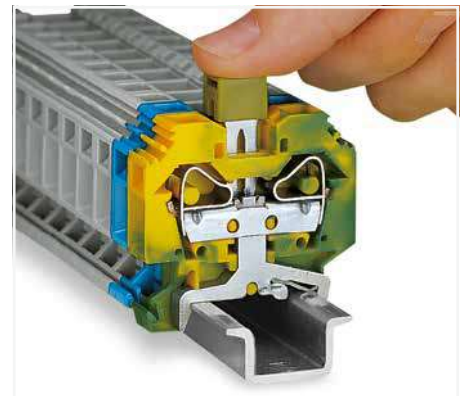

Push jumper down until fully inserted. Commoning ground conductor terminal blocks with through terminal blocks is possible in one direction only (via rear side of terminal block) using adjacent jumpers. Recommends using yellow-green adjacent jumpers in addition to the required marking of these blocks.

Through and Ground Conductor Terminal Block

10 mm²; 284 Series and 16 mm²; 283 Series

Technical Data

0.2 ... 10 mm ²	24 ... 8 AWG
800 V / 8 kV / 3 ①	600 V, 50 A ②
I _N 57 A	600 V, 65 A ③
Terminal block width: 10 mm / 0.394 inch	
 12 ... 13 mm / 0.47 ... 0.51 inch	

Technical Data

0.2 ... 16 mm ²	24 ... 6 AWG
800 V / 8 kV / 3 ①	600 V, 65 A ②
I _N 76 A	600 V, 90 A ③
Terminal block width: 12 mm / 0.472 inch	
 16 ... 17 mm / 0.63 ... 0.67 inch	



- ① 800 V = rated voltage
- ② 8 kV = rated impulse voltage
- ③ 3 = pollution degree (see Section 15)

See application notes for:
 Step-down jumper, page 541
 Test plug module, page 381
 Marking, from page 640

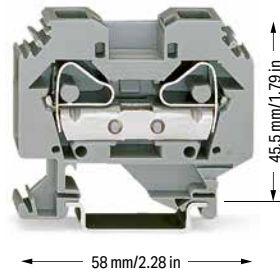
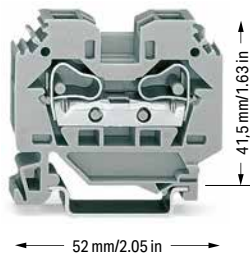

Approvals and corresponding ratings, visit www.wago.com



2-conductor through terminal block

Color	Item No.	Pack. Unit
 gray	284-101	50
 blue	284-104 ②	50

2-conductor through terminal block

Color	Item No.	Pack. Unit
 gray	283-101	50
 blue	283-104 ②	50

2-conductor ground terminal block

 green-yellow	284-107	50
---	---------	----

2-conductor ground terminal block

 green-yellow	283-107	50
--	---------	----



Accessories; item-specific

End and intermediate plate; 2.5 mm thick

	orange	284-302	100 (25)
	gray	284-301	100 (25)

Accessories; item-specific



End and intermediate plate; 4 mm thick

	orange	283-302	50 (25)
	gray	283-301	50 (25)

Separator; oversized; 2 mm thick

	orange	284-322	100 (25)
	gray	284-332	100 (25)

Separator; oversized; 2 mm thick

	orange	283-322	50 (25)
	gray	283-332	50 (25)

Adjacent jumper; insulated; I_N 57 A

	gray	284-402	100 (25)
	yellow-green	284-422	100 (25)

Adjacent jumper; insulated; I_N 70 A

	gray	283-402	50 (25)
	yellow-green	283-422	50 (25)

Alternate jumper; insulated; I_N 57 A

	gray	284-409	50 (25)
--	------	---------	---------

Alternate jumper; insulated; I_N 76 A

	gray	283-409	50 (25)
---	------	---------	---------

Step-down jumper; insulated; commons 10/6 mm² (8/10 AWG) down to 6/4 mm² (10/12 AWG); I_N 30 A

	gray	284-413	50 (25)
--	------	---------	---------

Step-down jumper; insulated; commons 16 mm² (6 AWG) down to 4 mm² (12 AWG); I_N 32 A

	gray	283-414	50 (25)
---	------	---------	---------

Step-down cover plate; 1 mm thick

	gray	284-333	100 (25)
	orange	284-343	100 (25)

Step-down cover plate; 1 mm thick

	gray	283-333	100 (25)
	orange	283-335	100 (25)

Protective warning marker; with black high-voltage symbol; for 5 terminal blocks

	yellow	284-405	50 (25)
--	--------	---------	---------

Protective warning marker; with black high-voltage symbol; for 5 terminal blocks

	yellow	283-405	50 (25)
---	--------	---------	---------

Test plug adapter; 8.3 mm wide; for 4 mm Ø test plug; for 1.5 ... 10 mm² terminal blocks

	gray	209-170	50 (25)
--	------	---------	---------

Test plug adapter; 8.3 mm wide; for 4 mm Ø test plug; for 1.5 ... 10 mm² terminal blocks

	gray	283-404	25
---	------	---------	----

B-type test plug module; snaps together; 8 mm wide

	gray	709-310	100 (25)
--	------	---------	----------



Step-down jumpers common terminal blocks of different sizes, without losing a conductor clamping point. This can be beneficial on long conductor runs where voltage drop can be a problem. A large conductor can be easily connected to smaller conductors at the distribution point.

Step-down jumpers are simply pushed down for full insertion, similar to adjacent jumpers. Commoning may be made in either direction using the special thin end plate to cover the open side. Additional through terminal blocks having a smaller cross-section may be commoned using adjacent jumpers.

In this case, pay attention that:
 The total current of the outgoing circuits does not exceed the nominal current of the step-down jumper.
 The standard or special thin cover plate is installed on the open side of the larger block.

11

Step-Down Jumper; for Side-Entry Through Terminal Blocks Installation



Step-down jumper; insulated; commons 10/6 mm² (8/10 AWG) down to 4/2.5/1.5 mm² (12/14/16 AWG); I_N 15 A

Color	Item No.	Pack. Unit
○ gray	284-414	50 (25)

Step-down jumper; insulated; commons 10/6 mm² (8/10 AWG) down to 6/4 mm² (10/12 AWG); I_N 30 A

○ gray	284-413	50 (25)
--------	---------	---------

Accessories; item-specific

Step-down cover plate; 1 mm thick

gray	284-333	100 (25)
orange	284-343	100 (25)

Step-down intermediate plate; 1 mm thick; only for 4, 2.5 and 1.5 mm² terminal blocks

gray	281-333	100 (25)
------	---------	----------

Step-down jumper; insulated; commons 16 mm² (6 AWG) down to 4 mm² (12 AWG); I_N 32 A

Color	Item No.	Pack. Unit
○ gray	283-414	50 (25)

Accessories; item-specific

Step-down cover plate; 1 mm thick

gray	283-333	100 (25)
orange	283-335	100 (25)

Side-entry terminal blocks cannot be commoned with front-entry terminal blocks via step-down jumpers. For commoning front-entry terminal blocks via step-down jumpers, see page 286.

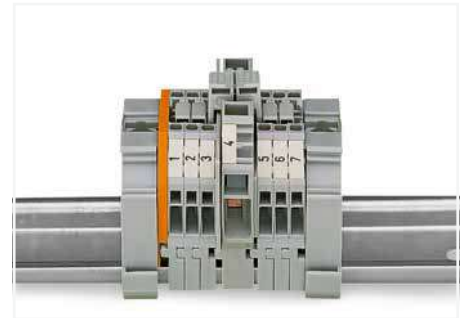

Commoning from 6 mm²/10 AWG (282 Series) to 1.5 mm²/16 AWG (279 Series) rail-mount terminal blocks via step-down jumpers.

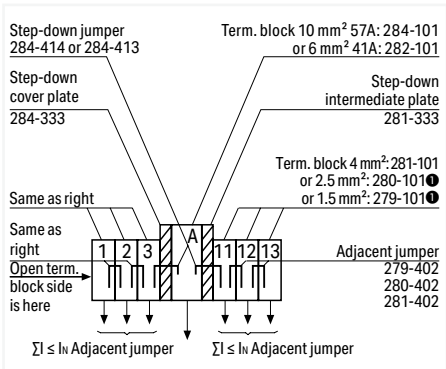

Assembly example: Commoning from 10/6 mm² (8/10 AWG) to 4/2.5/1.5 mm² (12/14/16 AWG) rail-mount terminal blocks via step-down jumper (284-414).

❶ Commoning with step-down jumpers from 10 mm² (284-101) to 2.5 mm² (280-101) or 1.5 mm² (279-101) terminal blocks via the terminal block rear side is not possible (see example: terminal block A to 11).

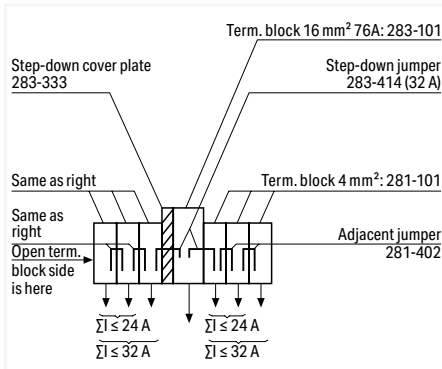

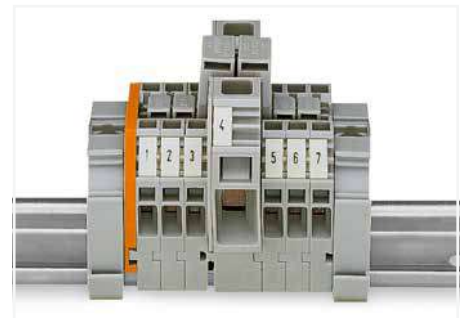

Assembly example: Commoning from 16 mm²/6 AWG to 4 mm²/12 AWG rail-mount terminal blocks via step-down jumper (283-414).

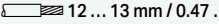

Commoning from 16 mm²/6 AWG (283 Series) to 4 mm²/12 AWG (281 Series) rail-mount terminal blocks via step-down jumpers.

Disconnect/Test Terminal Block 6 mm²; 282 Series

Technical Data	
0.2 ... 6 mm ²	24 ... 10 AWG
400 V / 6 kV / 3 ⚡	300 V, 30 A VA
I _N 41 A	300 V, 40 A Ⓜ
Terminal block width: 8 mm / 0.315 inch	
 12 ... 13 mm / 0.47 ... 0.51 inch	

Technical Data	
0.2 ... 6 mm ²	24 ... 10 AWG
400 V / 6 kV / 3 ⚡	300 V, 30 A VA
I _N 41 A	300 V, 40 A Ⓜ
Terminal block width: 8 mm / 0.315 inch	
 12 ... 13 mm / 0.47 ... 0.51 inch	

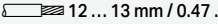
Technical Data	
0.2 ... 6 mm ²	24 ... 10 AWG
400 V / 6 kV / 3 ⚡	300 V, 30 A VA
I _N 41 A	300 V, 40 A Ⓜ
Terminal block width: 8 mm / 0.315 inch	
 12 ... 13 mm / 0.47 ... 0.51 inch	

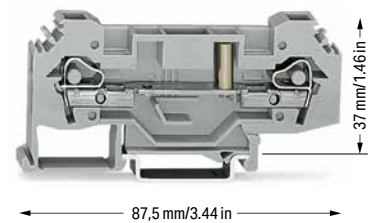
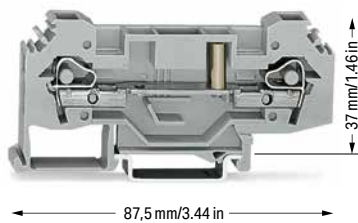
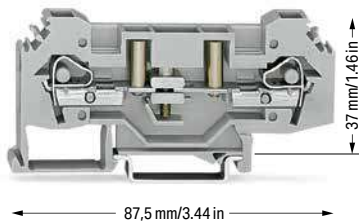

Disconnect/test terminal block; with 4 mm Ø test sockets		
Color	Item No.	Pack. Unit
○ gray	282-131	25

Through terminal block		
Color	Item No.	Pack. Unit
○ gray	282-133	25

Disconnect/test terminal block; without test sockets		
Color	Item No.	Pack. Unit
○ gray	282-135	25

Accessories; item-specific		
Alternate jumper; insulated; I _N 41 A		
	gray	282-409 100 (25)

Accessories; item-specific		
Alternate jumper; insulated; I _N 41 A		
	gray	282-409 100 (25)

Accessories; item-specific		
Alternate jumper; insulated; I _N 41 A		
	gray	282-409 100 (25)

Lock-out; prevents reclosing of slide link; snap-on type		
	orange	282-137 100 (25)

Test plug adapter; 8.3 mm wide; for 4 mm Ø test plug; for 1.5 ... 10 mm ² terminal blocks		
	gray	209-170 50 (25)

Lock-out; prevents reclosing of slide link; snap-on type		
	orange	282-137 100 (25)

Test plug adapter; 8.3 mm wide; for 4 mm Ø test plug; for 1.5 ... 10 mm ² terminal blocks		
	gray	209-170 50 (25)

B-type test plug module; snaps together; 8 mm wide		
	gray	709-310 100 (25)

Test plug adapter; 8.3 mm wide; for 4 mm Ø test plug; for 1.5 ... 10 mm ² terminal blocks		
	gray	209-170 50 (25)

B-type test plug module; snaps together; 8 mm wide		
	gray	709-310 100 (25)

B-type spacer module; snaps together; 8 mm wide		
	gray	709-311 100 (25)

B-type test plug module; snaps together; 8 mm wide		
	gray	709-310 100 (25)

B-type spacer module; snaps together; 8 mm wide		
	gray	709-311 100 (25)

B-type spacer module; snaps together; 8 mm wide		
	gray	709-311 100 (25)

Accessories; 282 Series Appropriate marking system: WMB

End and intermediate plate; 4 mm thick		
	gray	282-315 50 (25)
	orange	282-314 50 (25)

Protective warning marker; with black high-voltage symbol; for 5 terminal blocks		
	yellow	282-405 100 (25)

Adjacent jumper; insulated; I _N 41 A		
	gray	282-402 100 (25)

11

Technical Data

0.2 ... 6 mm² | 24 ... 10 AWG

Terminal block width: 16 mm / 0.63 inch

12 ... 13 mm / 0.47 ... 0.51 inch

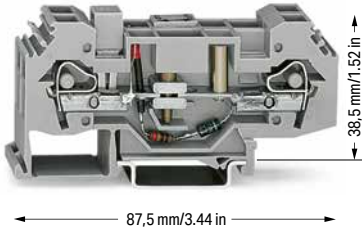

- 1 400 V = rated voltage
6 kV = rated impulse voltage
3 = pollution degree
(see Section 15)

See application notes for:
Test plug module, page 381
Marking, from page 640

Approvals and corresponding ratings,
visit www.wago.com

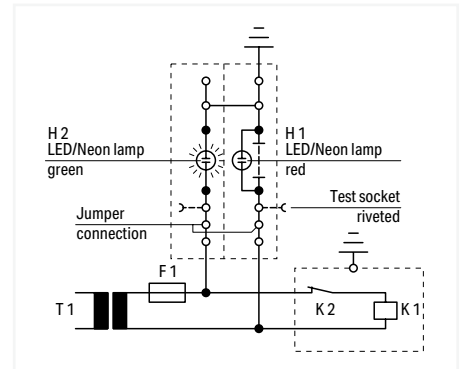

Operation
Slide link closed, auxiliary circuit grounded,
green LED/neon lamp illuminates.

Ground conductor disconnect terminal block; gray

Color	Item No.	Pack. Unit
○ 24 V	282-140	12
○ 48 V	282-141	12
○ 120 V	282-138	12
○ 230 V	282-139	12

Accessories; item-specific

Lock-out; prevents reclosing of slide link; snap-on type

	orange	282-137	100 (25)
--	--------	---------	----------

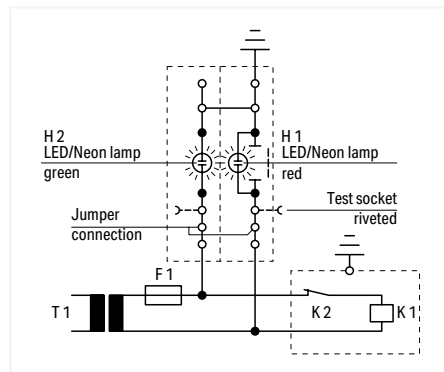

Test condition – no grounding
Slide link open, auxiliary circuit not grounded.

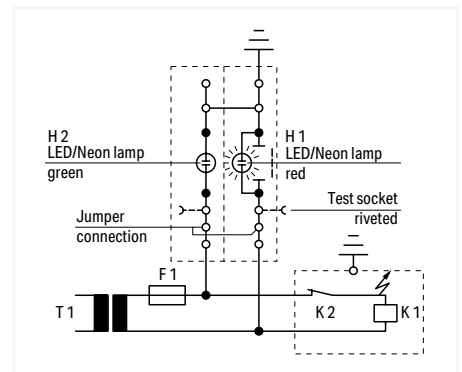

Test condition – grounding
Slide link open, auxiliary circuit not grounded,
red LED/neon lamp illuminates.

Current transformer circuit
with current path separation
and commoning possibility

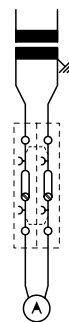

Current transformer circuit
with the connection of a second
test unit through test sockets

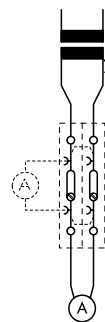

Transformer test circuit,
k-conductors of the
transformers connected

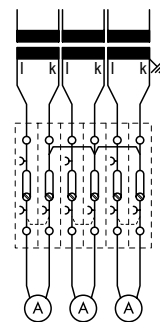

IEC 60204/DIN VDE 0113 "Safety of machinery – Electrical equipment of machines – Part 1: General requirements," Section 9.4.3.1:

Ground faults on control circuits must not cause unintentional starting, hazardous movements, or prevent stopping of the machine.

In order to fulfill this requirement, a connection to the protective bonding circuit must be provided in accordance with Section 8.2 and the devices must be connected as described in Section 9.1.4. Control circuits fed from a transformer and not connected to the protective bonding circuit must be provided with an insulation monitoring device (e.g., residual current device), which either indicates a ground fault or interrupts the circuit automatically after a ground fault.

In the case of electronic circuits, the connection of one side of the control circuit to the protective bonding circuit in accordance with Section 9.1.4 can prevent unintentional operation. When this does not help, or if due to other reasons that electronic circuits cannot be connected to the protective bonding circuit, other measures must be taken to achieve the same level of safety.

Multipole control switches that interrupt all live conductors must be used where the control circuit is directly connected between the phase conductors of the supply or between a phase conductor and a neutral conductor, which is either not grounded or grounded through a high impedance. This is required for starting or stopping machine functions, which can cause a hazardous situation including: damaging the machine or halting work in progress in the event of unintentional starting or failure to stop.

Fuse Terminal Block

6 mm²; 282 Series

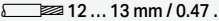
Technical Data	
0.2 ... 6 mm ²	24 ... 10 AWG
500 V / 6 kV / 3 ⚡	600 V, 10 A VA
I _N 10 A	250 V, 10 A Ⓢ
Terminal block width: 13 mm / 0.512 inch	
 12 ... 13 mm / 0.47 ... 0.51 inch	

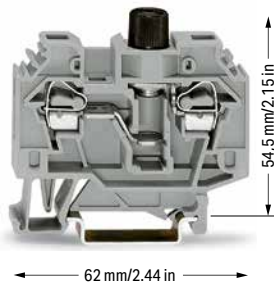

2-conductor fuse terminal block; for 5 x 20 mm miniature metric fuse; without blown fuse indication

Color	Item No.	Pack. Unit
○ gray	282-122	40

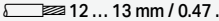
Technical Data	
0.2 ... 6 mm ²	24 ... 10 AWG
500 V / 6 kV / 3 ⚡	600 V, 10 A VA
I _N 10 A	250 V, 10 A Ⓢ
Terminal block width: 13 mm / 0.512 inch	
 12 ... 13 mm / 0.47 ... 0.51 inch	

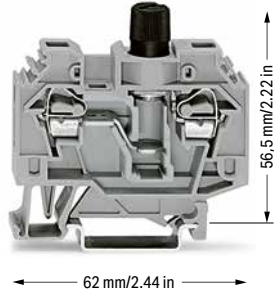

2-conductor fuse terminal block; for glass cartridge fuse 1/4" x 1 1/4"; without blown fuse indication

Color	Item No.	Pack. Unit
○ gray	282-120	40

2-conductor fuse terminal block; for glass cartridge fuse 1/4" x 1 1/4"; without blown fuse indication

○ gray	282-128	40
--------	---------	----

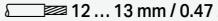
Technical Data	
0.2 ... 6 mm ²	24 ... 10 AWG
500 V / 6 kV / 3 ⚡	600 V, 10 A VA
I _N 10 A	250 V, 10 A Ⓢ
Terminal block width: 13 mm / 0.512 inch	
 12 ... 13 mm / 0.47 ... 0.51 inch	

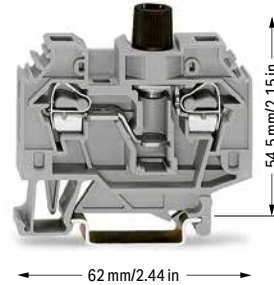

2-conductor fuse terminal block; for 5 x 25 mm miniature metric fuse; without blown fuse indication

Color	Item No.	Pack. Unit
○ gray	282-126	40

Accessories; item-specific

Glass cartridge fuse; without indicator; 5 x 20 mm; 6.3 A / 250 V; medium-acting



282-451	100
---------	-----

Accessories; item-specific

Glass cartridge fuse; without indicator; 1/4" x 1", 10 A / 240 V; per BS 1362



282-458	200 (10)
---------	----------

Glass cartridge fuse; without indicator; 1/4" x 1 1/4"; 10 A / 250 V; medium-acting



282-457	200 (100)
---------	-----------

Glass cartridge fuse; without indicator; 1/4" x 1 1/4"; very fast-acting



282-454	200 (10)
---------	----------

Accessories; item-specific

Glass cartridge fuse; with indicator; 5 x 25 mm; 6.3 A / 250 V; medium-acting



282-452	200 (10)
---------	----------

Glass cartridge fuse; with indicator; 5 x 25 mm, 10 A / 450 V; fast-acting



282-453	200 (10)
---------	----------

Accessories; 282 Series

Appropriate marking system: WMB

End and intermediate plate; 4 mm thick



orange	282-312	50 (25)
gray	282-311	50 (25)

Protective warning marker; with black high-voltage symbol; for 5 terminal blocks



yellow	282-405	100 (25)
--------	---------	----------

Adjacent jumper; insulated; I_N 41 A



gray	282-402	100 (25)
------	---------	----------

Test plug adapter; 8.3 mm wide; for 4 mm Ø test plug; for 1.5 ... 10 mm² terminal blocks



gray	209-170	50 (25)
------	---------	---------

Test plug adapter; 6 mm wide; with CAGE CLAMP®; for 0.08 ... 2.5 mm²



I _N 24 A	281-407	100 (25)
---------------------	---------	----------

Operating pliers; for 281, 282, 283, 284 Series side-entry rail-mounted terminal blocks



210-141	1
---------	---

Technical Data	
0.2 ... 6 mm ²	24 ... 10 AWG

Terminal block width: 13 mm / 0.512 inch
 12 ... 13 mm / 0.47 ... 0.51 inch

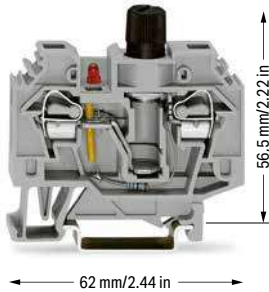

2-conductor fuse terminal block; for glass cartridge fuse ¼" x 1¼"; with 24 VDC red LED

Color	Item No.	Pack. Unit
○ gray	282-128/281-413	40

Technical Data	
0.2 ... 6 mm ²	24 ... 10 AWG

Terminal block width: 13 mm / 0.512 inch
 12 ... 13 mm / 0.47 ... 0.51 inch

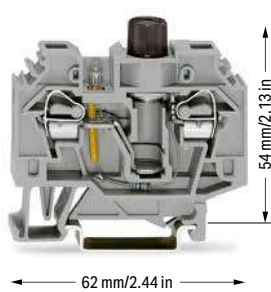

2-conductor fuse terminal block; for glass cartridge fuse ¼" x 1¼"; with 250 VAC/220 VDC neon lamp

Color	Item No.	Pack. Unit
○ gray	282-128/281-417	40

2-conductor fuse terminal block; for 5 x 20 mm miniature metric fuse; with 250 VAC/220 VDC neon lamp

○ gray	282-124	40
--------	---------	----

2-conductor fuse terminal block; for glass cartridge fuse ¼" x 1¼"; with 120 VAC/DC neon lamp

○ gray	282-128/281-418	40
--------	-----------------	----

Accessories; item-specific

Glass cartridge fuse; without indicator; ¼" x 1¼"; 10 A / 250 V; medium-acting



282-457	200 (100)
---------	-----------

Glass cartridge fuse; without indicator; ¼" x 1¼"; very fast-acting



282-454	200 (10)
---------	----------

Accessories; item-specific

Glass cartridge fuse; without indicator; 5 x 20 mm; 6.3 A / 250 V; medium-acting



282-451	100
---------	-----

Glass cartridge fuse; without indicator; ¼" x 1¼"; 10 A / 250 V; medium-acting



282-457	200 (100)
---------	-----------

Glass cartridge fuse; without indicator; ¼" x 1¼"; very fast-acting



282-454	200 (10)
---------	----------

- ① 500 V = rated voltage
- 6 kV = rated impulse voltage
- 3 = pollution degree (see Section 15)
- Electrical ratings are given by the fuse or LED nominal voltage (see page 344).

Approvals and corresponding ratings, visit www.wago.com

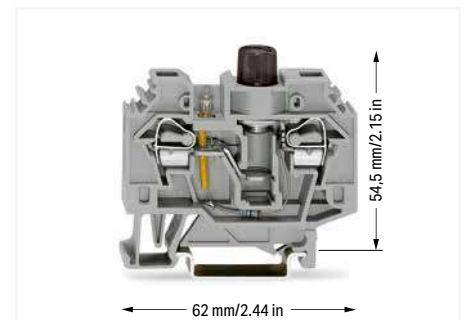

Dimensions in mm
Item No. 282-124

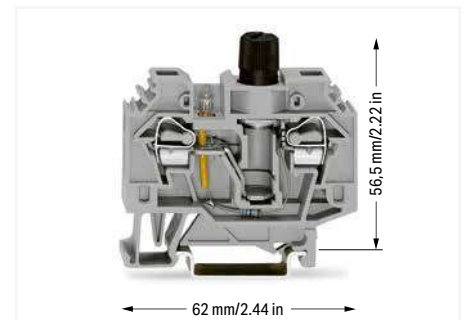

Dimensions in mm
Item No. 282-128/281-418

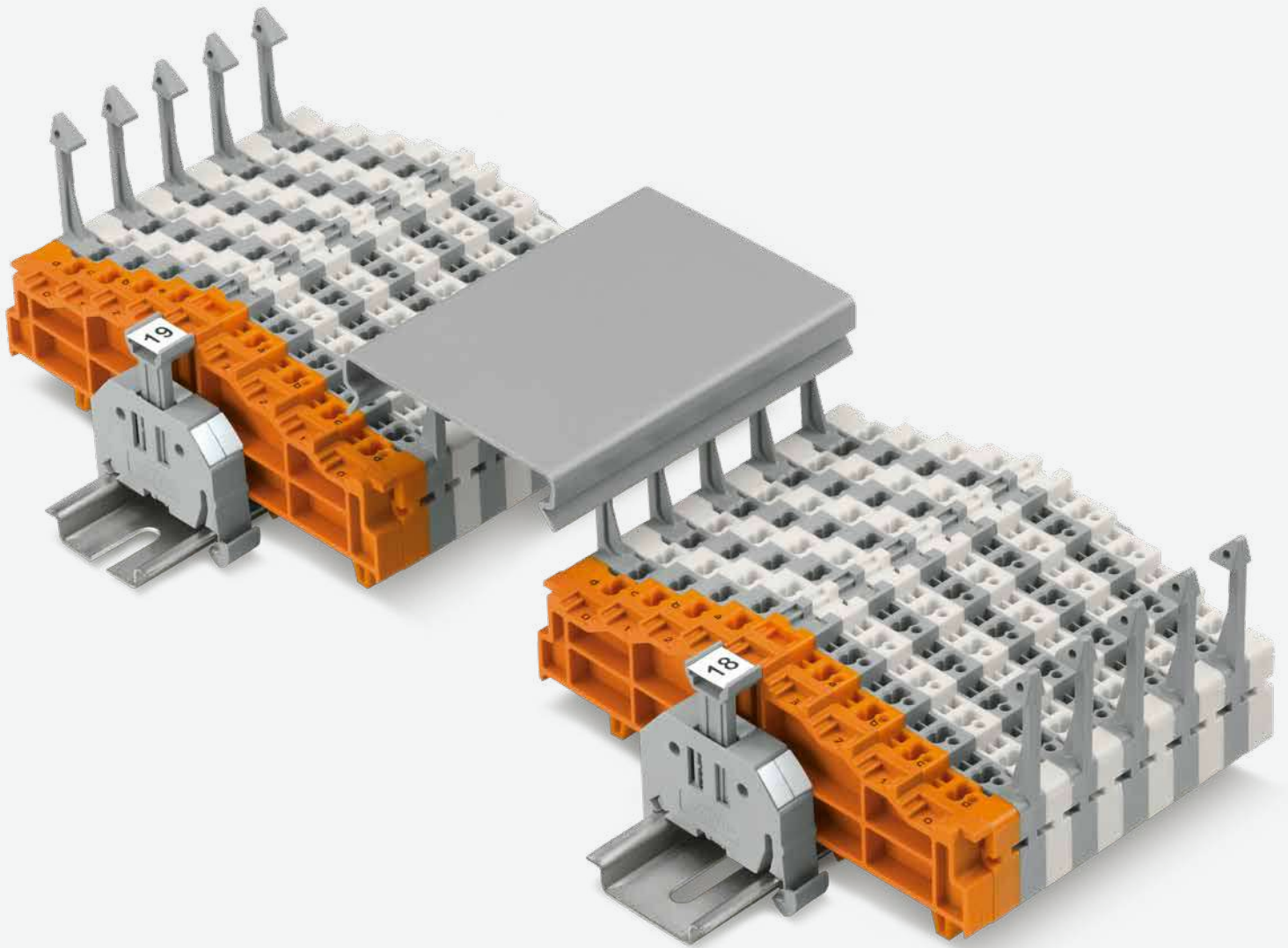







WAGO Patchboard Systems

WAGO Busbar Terminal Blocks

WAGO Patchboard Systems

WAGO Busbar Terminal Blocks

			Page
	Matrix Patchboards	726 Series	592
	Common Potential Matrix Patchboards Marking on the Patchboard Side Marking on the Supply Side	726 Series	596
	Matrix Patchboard Accessories		600
	Terminal Blocks for Matrix Patching and Common Potential Terminal Blocks 1.5 mm ² (16 AWG)	727 Series	604
	3-Conductor, Double-Potential Terminal Blocks 2.5 mm ² (14 AWG)	280 Series	608
	Busbar Terminal Blocks	812 Series	611

Matrix Patchboards

726 Series

Description and Installation

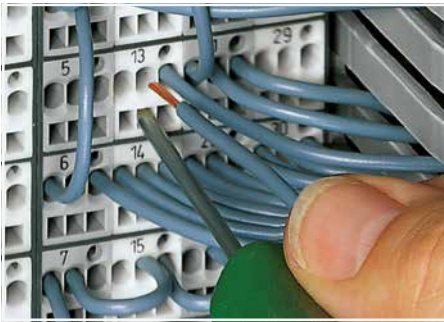

CAGE CLAMP® connection
Inserting a conductor via 210-719 Operating Tool (2.5 x 0.4 mm blade).



Factory-marked modules
Side 1: 1, 2, 3, 4 ...

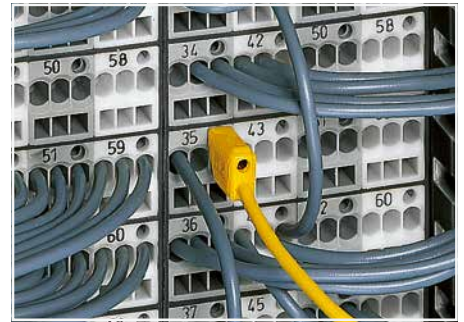

Testing with a 2.3 mm Ø test plug.

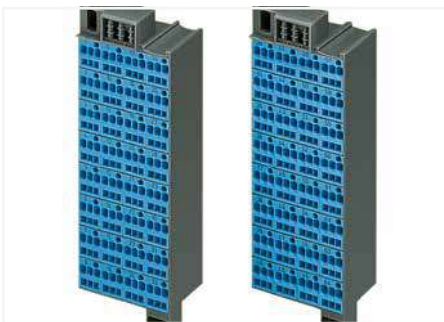

Blue matrix patchboards are suitable for Ex i applications.

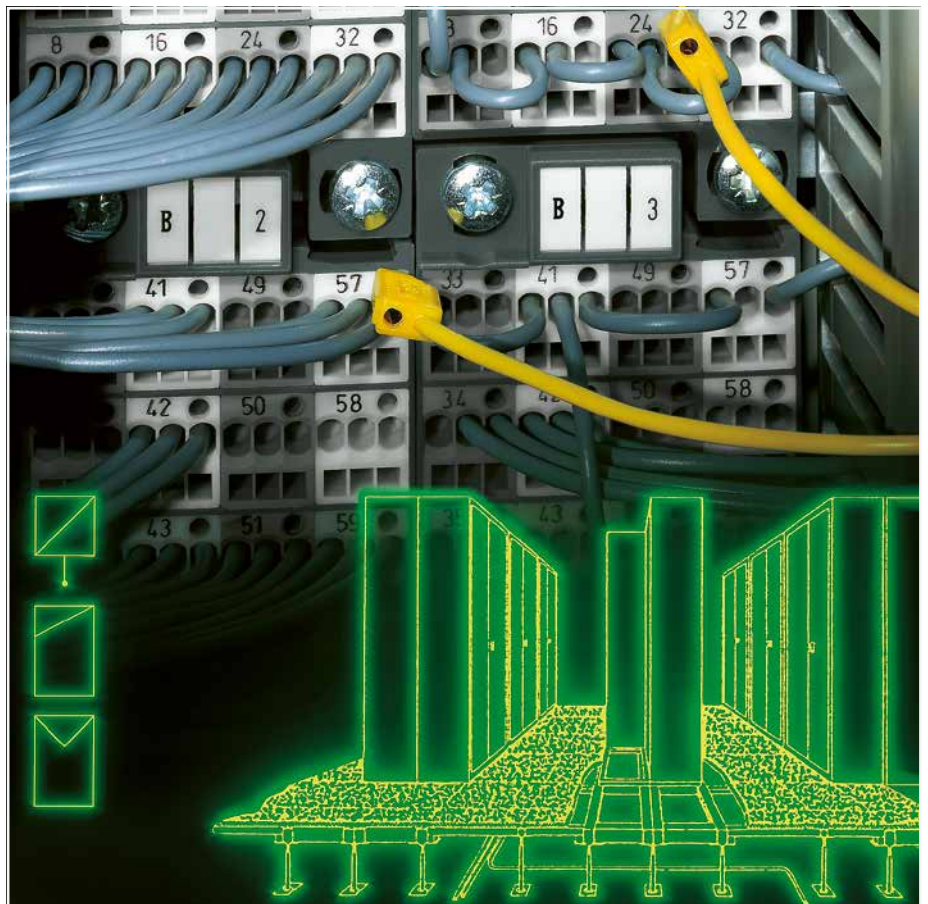

12



Individual group marking via WSB Quick Marking System.



Installation example:
Matrix patchboards in a frame

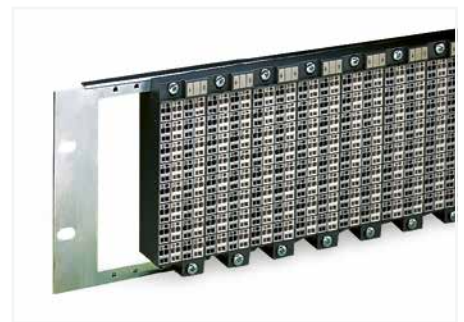

Installation example:
Matrix patchboards in a 19" rack



CAGE CLAMP® terminates the following copper conductors:
solid "s"



stranded "st"



fine-stranded "f-st",
also with tinned
single strands

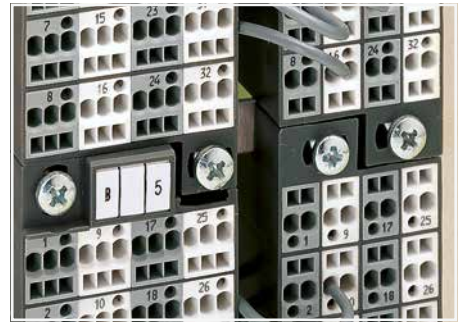

Space saving:
Slimline matrix patchboard (lower right), mounted upside down



Snapping on an additional module with contact to mounting frame.



Assembling a matrix patchboard with additional module – direct connection to the mounting frame.

	Max. conductor cross section (mm ² /AWG) without ferrule	Max. conductor cross section (mm ² /AWG) with ferrule			
		insulated		uninsulated	
Side 2	1.5	0.75	Item No./Color 216-202/ gray	1	Item No. 216-103
Side 1	1.5	0.75	216-202/ gray	1	216-103
Side 2	2.5	1.5	216-204/ black	1.5	216-104
Side 1	1.5	0.75	216-202/ gray	1	216-103



Terminating ferruled conductors via operating tool.



fine-stranded, tip-bonded



fine-stranded, with ferrule (gastight crimped)



fine-stranded, with pin terminal (gastight crimped)

Matrix Patchboard; 32-Pole 726 Series

Technical Data		Technical Data	
Side 1: 3x 0.08 ... 1.5 mm ²	28 ... 16 AWG	Side 1: 3x 0.08 ... 1.5 mm ²	28 ... 16 AWG
Side 2: 3x 0.08 ... 1.5 mm ²	28 ... 16 AWG	Side 2: 2x 0.08 ... 2.5 mm ²	28 ... 14 AWG
500 V / 6 kV / 3 ①	300 V, 10 A	500 V / 6 kV / 3 ①	300 V, 10 A
I _N 10 A	300 V, 10 A	I _N 10 A	300 V, 10 A
8 ... 10 mm / 0.31 ... 0.39 inch		8 ... 10 mm / 0.31 ... 0.39 inch	



Dimensions in mm

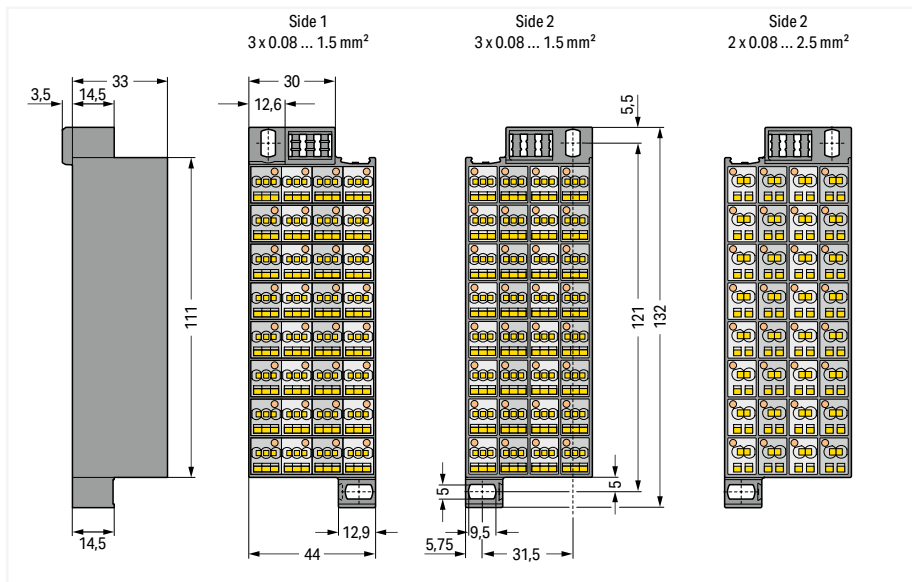

Matrix patchboard; Dark gray frame; Gray/white modules; Vertical module marking on sides 1 and 2; 32-pole			Matrix patchboard; Dark gray frame; Gray/white modules; Vertical module marking on sides 1 and 2; 32-pole		
Marking	Item No.	Pack. Unit	Marking	Item No.	Pack. Unit
1 ... 32	726-121	20	1 ... 32	726-221	20
33 ... 64	726-122	20	33 ... 64	726-222	20

Matrix patchboard; Dark gray frame; Blue modules; Vertical module marking on sides 1 and 2; 32-pole			Matrix patchboard; Dark gray frame; Blue modules; Vertical module marking on sides 1 and 2; 32-pole		
Marking	Item No.	Pack. Unit	Marking	Item No.	Pack. Unit
1 ... 32	726-141	20	1 ... 32	726-241	20
33 ... 64	726-142	20	33 ... 64	726-242	20

Accessories; for Matrix Patchboards
Appropriate marking systems: WMB/WMB Inline/Marking strips

Insulation stop; 0.08 ... 0.2 mm ² "s" (0.14 mm ² "f-st"); 4 x 3 pcs/strip	white	726-901	200 (25)	Insulation stop; 0.25 ... 0.5 mm ² "s+f-st"; 4 x 3 pcs/strip	dark gray	726-907	200 (25)
Insulation stop; 0.25 mm ² "s"; 0.14 ... 0.25 mm ² "f-st"; 4 x 3 pcs/strip	light gray	726-906	200 (25)	Wire commoning chain; insulated; 32 connections; I _N 6 A; max. 50 V; 0.5 mm ²	gray	709-107	1

① 500 V = rated voltage
6 kV = rated impulse voltage
3 = pollution degree
(see Section 15)

② Suitable for Ex i applications

See application notes for:
Insulation stop, page 559

Approvals and corresponding ratings,
visit www.wago.com

Accessories; for Matrix Patchboards

Appropriate marking systems:
WMB/WMB Inline/Marking strips

Group marker carrier for side 2

	dark gray	726-902	50
--	-----------	---------	----

WMB marking card; white; 10 strips with 10 markers/card; 5 ... 5.2 mm stretchable

	plain	793-5501	5
--	-------	----------	---

WMB marking card; white; 10 strips with 10 markers/card; horizontal marking

	1 ... 10 (10x)	793-5502	5
--	----------------	----------	---

WMB marking card; white; 10 strips with 10 markers/card; horizontal marking

	1 ... 50 (2x)	793-5566	5
--	---------------	----------	---

WMB marking card; white; 10 strips with 10 markers/card; horizontal marking

	X (100x)	793-5500/793-035	5
--	----------	------------------	---

Operating tool with a partially insulated shaft; Type 1; (2.5 x 0.4) mm blade

		210-719	1
--	--	---------	---

12

Matrix Patchboard; 48-Pole 726 Series

Technical Data

Side 1: 3x 0.08 ... 1.5 mm ²	28 ... 16 AWG
Side 2: 3x 0.08 ... 1.5 mm ²	28 ... 16 AWG
500 V / 6 kV / 3 ①	300 V, 10 A ②
I _N 10 A	300 V, 10 A ③
8 ... 10 mm / 0.31 ... 0.39 inch	

Technical Data

Side 1: 3x 0.08 ... 1.5 mm ²	28 ... 16 AWG
Side 2: 2x 0.08 ... 2.5 mm ²	28 ... 14 AWG
500 V / 6 kV / 3 ①	300 V, 10 A ②
I _N 10 A	300 V, 10 A ③
8 ... 10 mm / 0.31 ... 0.39 inch	

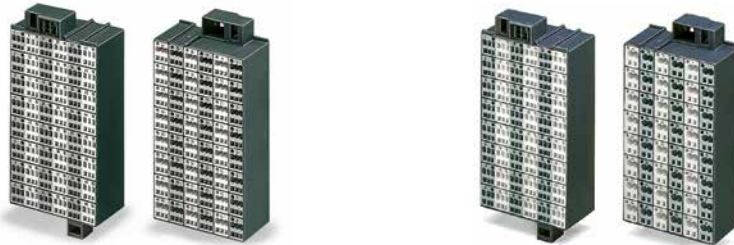

Dimensions in mm

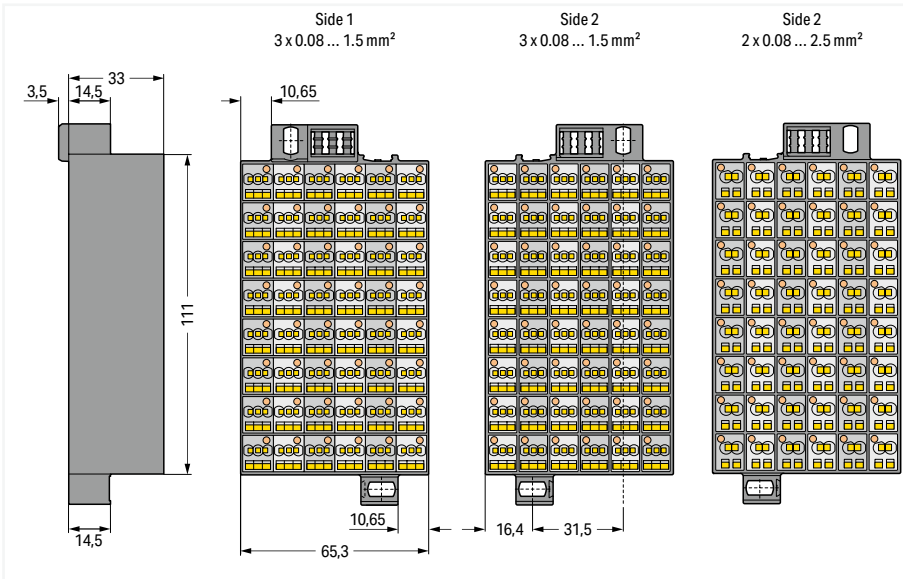

Matrix patchboard; Dark gray frame; Gray/white modules; Vertical module marking on sides 1 and 2; 48-pole

Marking	Item No.	Pack. Unit
1 ... 48	726-421	10

Matrix patchboard; Gray/white modules; Module marking on dark gray frame; Vertical module marking on sides 1 and 2; 48-pole

Marking	Item No.	Pack. Unit
1 ... 48	726-521	10

Matrix patchboard; Dark gray frame; Blue modules; Vertical module marking on sides 1 and 2; 48-pole

1 ... 48	726-441 ②	10
----------	-----------	----

Matrix patchboard; Dark gray frame; Blue modules; Vertical module marking on sides 1 and 2; 48-pole

1 ... 48	726-541 ②	10
----------	-----------	----

Accessories; for Matrix Patchboards

Appropriate marking systems: WMB/WMB Inline/Marking strips

Insulation stop; 0.08 ... 0.2 mm² "s" (0.14 mm² "f-st"); 4 x 3 pcs/strip

white	726-901	200 (25)
-------	---------	----------

Insulation stop; 0.25 mm² "s"; 0.14 ... 0.25 mm² "f-st"; 4 x 3 pcs/strip

light gray	726-906	200 (25)
------------	---------	----------

Insulation stop; 0.25 ... 0.5 mm² "s+f-st"; 4 x 3 pcs/strip

dark gray	726-907	200 (25)
-----------	---------	----------

Wire commoning chain; insulated; 32 connections; I_N 6 A; max. 50 V; 0.5 mm²

gray	709-107	1
------	---------	---

Group marker carrier for side 2

dark gray	726-902	50
-----------	---------	----

① 500 V = rated voltage
6 kV = rated impulse voltage
3 = pollution degree
(see Section 15)

② Suitable for Ex i applications

See application notes for:
Insulation stop, page 559

Approvals and corresponding ratings,
visit www.wago.com

Accessories; for Matrix Patchboards

Appropriate marking systems:
WMB/WMB Inline/Marking strips

WMB marking card; white; 10 strips with 10 markers/card;
5 ... 5.2 mm stretchable

plain	793-5501	5
-------	----------	---

WMB marking card; white; 10 strips with 10 markers/card;
horizontal marking

1 ... 10 (10x)	793-5502	5
----------------	----------	---

WMB marking card; white; 10 strips with 10 markers/card;
horizontal marking

1 ... 50 (2x)	793-5566	5
---------------	----------	---

WMB marking card; white; 10 strips with 10 markers/card;
horizontal marking

X (100x)	793-5500/793-035	5
----------	------------------	---

Operating tool with a partially insulated shaft; Type 1; (2.5 x 0.4) mm blade

	210-719	1
--	---------	---

Matrix Patchboard; 80-Pole 726 Series

Technical Data		Technical Data	
Side 1: 3x 0.08 ... 1.5 mm ²	28 ... 16 AWG	Side 1: 3x 0.08 ... 1.5 mm ²	28 ... 16 AWG
Side 2: 3x 0.08 ... 1.5 mm ²	28 ... 16 AWG	Side 2: 2x 0.08 ... 2.5 mm ²	28 ... 14 AWG
500 V / 6 kV / 3 ①	300 V, 10 A ②	500 V / 6 kV / 3 ①	300 V, 10 A ②
I _n 10 A	300 V, 10 A ②	I _n 10 A	300 V, 10 A ②
8 ... 10 mm / 0.31 ... 0.39 inch		8 ... 10 mm / 0.31 ... 0.39 inch	

- ① 500 V = rated voltage
6 kV = rated impulse voltage
3 = pollution degree
(see Section 15)
 - ② Suitable for Ex i applications
- See application notes for:
Insulation stop, page 559
- Approvals and corresponding ratings,
visit www.wago.com

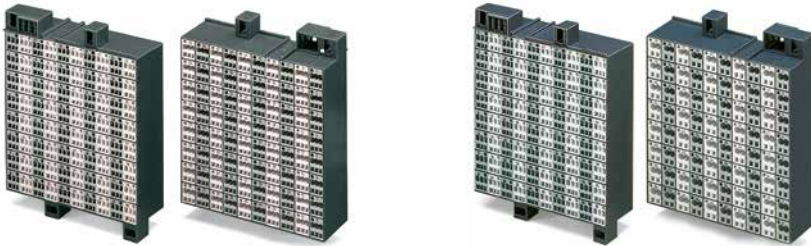

Dimensions in mm

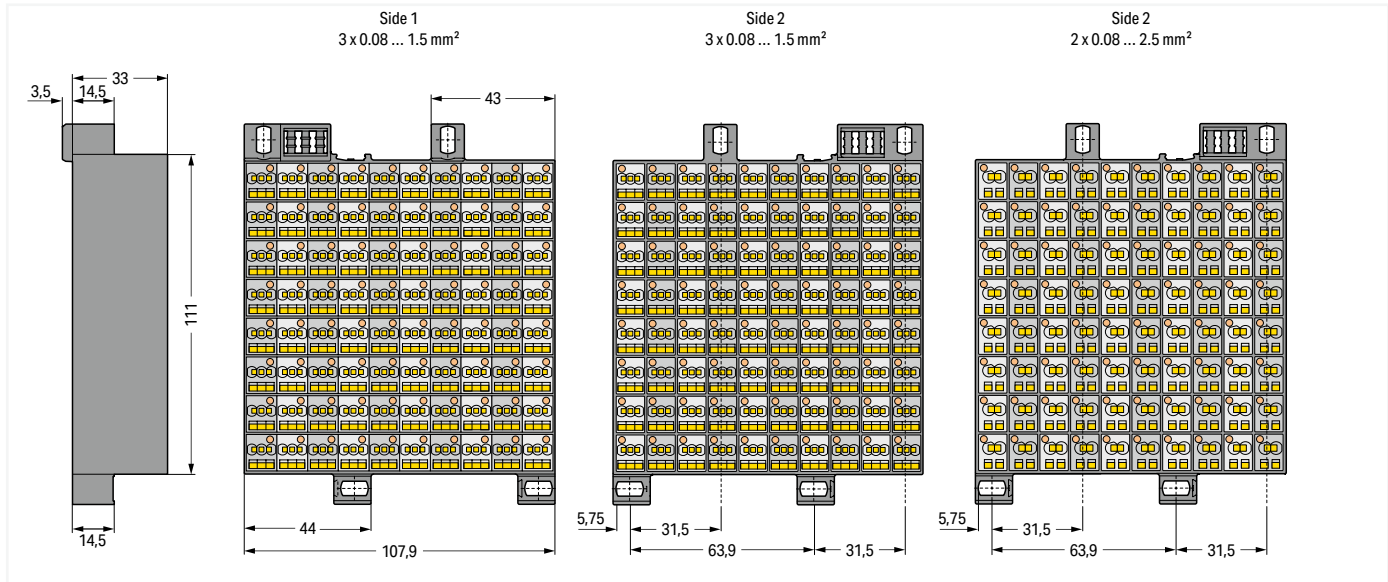

Matrix patchboard; Dark gray frame; Gray/white modules; Vertical module marking on sides 1 and 2; 80-pole	Matrix patchboard; Dark gray frame; Gray/white modules; Vertical module marking on sides 1 and 2; 80-pole
Marking	Marking
Item No.	Item No.
Pack. Unit	Pack. Unit
1 ... 80	1 ... 80
726-721	726-821
8	8
Matrix patchboard; Dark gray frame; Blue modules; Vertical module marking on sides 1 and 2; 80-pole	Matrix patchboard; Dark gray frame; Blue modules; Vertical module marking on sides 1 and 2; 80-pole
Marking	Marking
Item No.	Item No.
Pack. Unit	Pack. Unit
1 ... 80	1 ... 80
726-741 ②	726-841 ②
8	8

Accessories; for Matrix Patchboards

Appropriate marking systems:
WMB/WMB Inline/Marking strips

WMB marking card; white; 10 strips with 10 markers/card; horizontal marking	X (100x)	793-5500/793-035	5
---	----------	------------------	---

12

Accessories; for Matrix Patchboards

Appropriate marking systems: WMB/WMB Inline/Marking strips

Insulation stop; 0.08 ... 0.2 mm ² "s" (0.14 mm ² "f-st"); 4 x 3 pcs/strip	WMB marking card; white; 10 strips with 10 markers/card; 5 ... 5.2 mm stretchable
white	plain
726-901	793-5501
200 (25)	5
Insulation stop; 0.25 mm ² "s"; 0.14 ... 0.25 mm ² "f-st"; 4 x 3 pcs/strip	WMB marking card; white; 10 strips with 10 markers/card; horizontal marking
light gray	1 ... 10 (10x)
726-906	793-5502
200 (25)	5
Insulation stop; 0.25 ... 0.5 mm ² "s+f-st"; 4 x 3 pcs/strip	WMB marking card; white; 10 strips with 10 markers/card; horizontal marking
dark gray	1 ... 50 (2x)
726-907	793-5566
200 (25)	5

Operating tool with a partially insulated shaft; Type 1; (2.5 x 0.4) mm blade

210-719 1

Matrix Patchboard; Slimline Version; for 19" Racks; 32-Pole 726 Series

Technical Data		Technical Data	
Side 1: 2x 0.08 ... 1.5 mm ²	28 ... 16 AWG	Side 1: 2x 0.08 ... 1.5 mm ²	28 ... 16 AWG
Side 2: 2x 0.08 ... 1.5 mm ²	28 ... 16 AWG	Side 2: 2x 0.08 ... 1.5 mm ²	28 ... 16 AWG
500 V / 6 kV / 3 ①	300 V, 10 A	500 V / 6 kV / 3 ①	300 V, 10 A
I _N 10 A	300 V, 10 A	I _N 10 A	300 V, 10 A
8 ... 10 mm / 0.31 ... 0.39 inch		8 ... 10 mm / 0.31 ... 0.39 inch	



Dimensions in mm

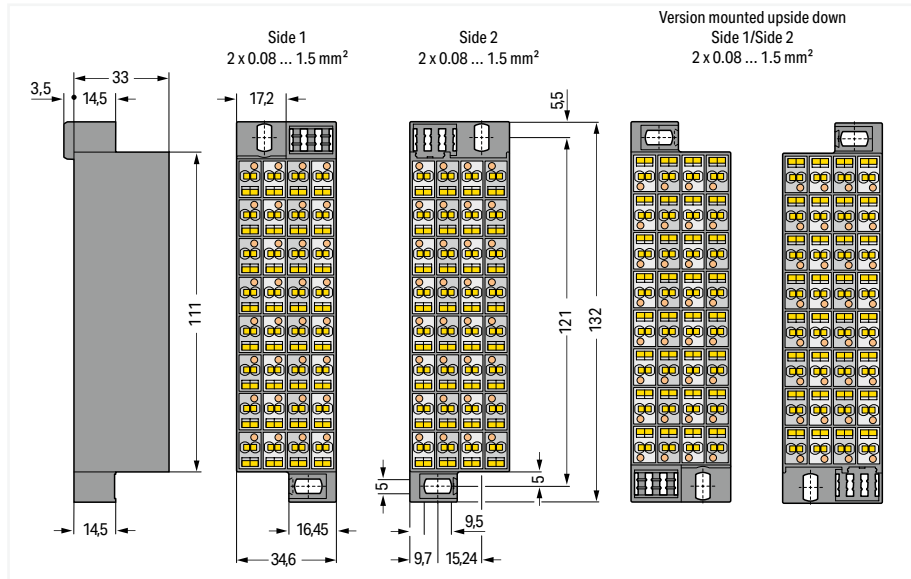

Matrix patchboard; Dark gray frame; Gray/white modules; Vertical module marking on sides 1 and 2; for 19" racks; Slimline version; 32-pole

Marking	Item No.	Pack. Unit	Marking	Item No.	Pack. Unit
1 ... 32	726-321	24	1 ... 32	726-325	24
33 ... 64	726-322	24	33 ... 64	726-326	24

Matrix patchboard; Dark gray frame; Blue modules; Vertical module marking on sides 1 and 2; for 19" racks; Slimline version; 32-pole

1 ... 32	726-341 ②	24
33 ... 64	726-342 ②	24

Matrix patchboard; Dark gray frame; Blue modules; Vertical module marking on sides 1 and 2; for 19" racks; Mounted upside down; Slimline version; 32-pole

1 ... 32	726-345 ②	24
33 ... 64	726-346 ②	24

Accessories; for Matrix Patchboards

Appropriate marking systems: WMB/WMB Inline/Marking strips

Insulation stop; 0.08 ... 0.2 mm ² "s" (0.14 mm ² "f-st"); 4 x 3 pcs/strip		
white	726-901	200 (25)

Insulation stop; 0.25 mm ² "s"; 0.14 ... 0.25 mm ² "f-st"; 4 x 3 pcs/strip		
light gray	726-906	200 (25)

Insulation stop; 0.25 ... 0.5 mm ² "s+f-st"; 4 x 3 pcs/strip		
dark gray	726-907	200 (25)

- ① 500 V = rated voltage
6 kV = rated impulse voltage
3 = pollution degree
(see Section 15)

- ② Suitable for Ex i applications

See application notes for:
Insulation stop, page 559

Approvals and corresponding ratings,
visit www.wago.com

Accessories; for Matrix Patchboards

Appropriate marking systems:
WMB/WMB Inline/Marking strips

WMB marking card; white; 10 strips with 10 markers/card;
5 ... 5.2 mm stretchable

plain	793-5501	5
-------	----------	---

WMB marking card; white; 10 strips with 10 markers/card;
horizontal marking

1 ... 10 (10x)	793-5502	5
----------------	----------	---

WMB marking card; white; 10 strips with 10 markers/card;
horizontal marking

1 ... 50 (2x)	793-5566	5
---------------	----------	---

WMB marking card; white; 10 strips with 10 markers/card;
horizontal marking

X (100x)	793-5500/793-035	5
----------	------------------	---

Operating tool with a partially insulated shaft; Type 1; (2.5 x 0.4) mm blade

screwdriver	210-719	1
-------------	---------	---

Common Potential Matrix Patchboard; Slimline Version; for 19" Racks

726 Series

Technical Data

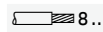
Side 1: I_N 24 A
 24x 2x 0.08 ... 2.5 mm² | 28 ... 14 AWG
 8 ... 10 mm / 0.31 ... 0.39 inch

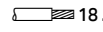
Side 2: I_N 76 A
 1x or 2x 0.5 ... 16 (25 "f-st") mm² | 20 ... 4 AWG
 18 ... 20 mm / 0.71 ... 0.79 inch

Technical Data

Side 1: I_N 24 A
 24x 2x 0.08 ... 2.5 mm² | 28 ... 14 AWG
 8 ... 10 mm / 0.31 ... 0.39 inch

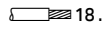
Side 2: I_N 76 A
 1x or 2x 0.5 ... 16 (25 "f-st") mm² | 20 ... 4 AWG
 18 ... 20 mm / 0.71 ... 0.79 inch

Technical Data

Side 1:
 24x 2x 0.08 ... 2.5 mm² | 28 ... 14 AWG
 8 ... 10 mm / 0.31 ... 0.39 inch

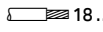
Side 2:
 1x or 2x 0.5 ... 16 (25 "f-st") mm² | 20 ... 4 AWG
 18 ... 20 mm / 0.71 ... 0.79 inch

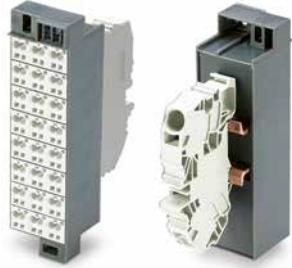

Dimensions in mm

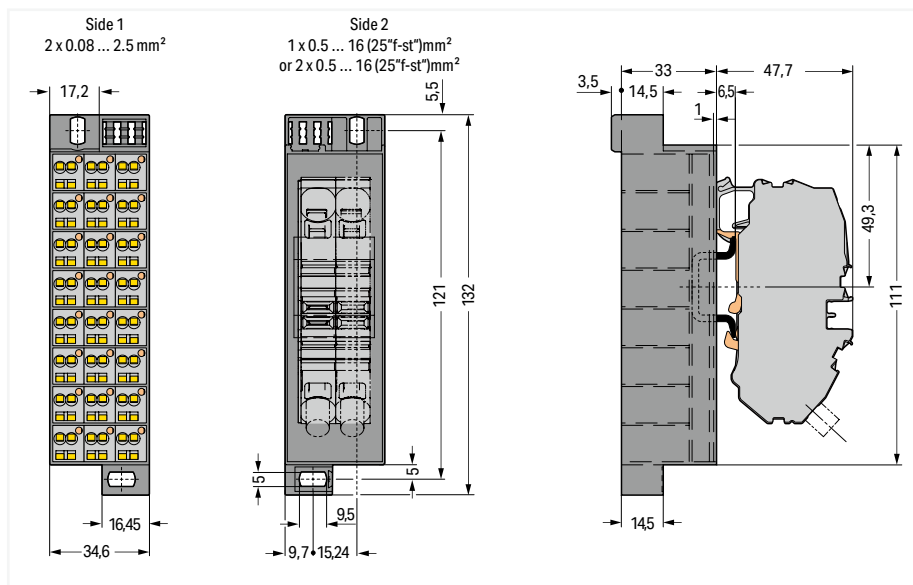

Common potential matrix patchboard; Dark gray frame; Marking 1 ... 24; Gray modules; Vertical module marking; with one supply terminal block incl. end plate; for 19" racks; Slimline version

Item No.	Pack. Unit
726-601	10

Common potential matrix patchboard; Dark gray frame; Marking 1 ... 24; White modules; Vertical module marking; with one supply terminal block incl. end plate; for 19" racks; Slimline version

Item No.	Pack. Unit
726-611	10

Common potential matrix patchboard; Dark gray frame; Marking 1 ... 24; Green-yellow modules; Vertical module marking; with one supply terminal block incl. end plate; for 19" racks; Slimline version

Item No.	Pack. Unit
726-621	10

12

Common potential matrix patchboard; Dark gray frame; Marking 1 ... 24; Gray modules; Vertical module marking; with two supply terminal blocks incl. end plate; for 19" racks; Slimline version

Item No.	Pack. Unit
726-602	10

Common potential matrix patchboard; Dark gray frame; Marking 1 ... 24; White modules; Vertical module marking; with two supply terminal blocks incl. end plate; for 19" racks; Slimline version

Item No.	Pack. Unit
726-612	10

Common potential matrix patchboard; Dark gray frame; Marking 1 ... 24; Green-yellow modules; Vertical module marking; with two supply terminal blocks incl. end plate; for 19" racks; Slimline version

Item No.	Pack. Unit
726-622	10

Accessories; item-specific

Spare supply terminal block; only for use with common potential matrix patchboards (726Series); 16 mm²; 12 mm wide

Color	Item No.	Pack. Unit
gray	2016-7611	20

End and intermediate plate; 1 mm thick

Color	Item No.	Pack. Unit
gray	2016-7691	100 (25)

Operating tool with a partially insulated shaft; Type 3; (5.5 x 0.8) mm blade

Item No.	Pack. Unit
210-721	1

Accessories; item-specific

Spare supply terminal block; only for use with common potential matrix patchboards (726Series); 16 mm²; 12 mm wide

Color	Item No.	Pack. Unit
white	2016-7608	20

End and intermediate plate; 1 mm thick

Color	Item No.	Pack. Unit
gray	2016-7691	100 (25)

Operating tool with a partially insulated shaft; Type 3; (5.5 x 0.8) mm blade

Item No.	Pack. Unit
210-721	1

Accessories; item-specific

Ground supply terminal block; 2-conductor ground terminal block; 16 mm²; 12 mm wide



Color	Item No.	Pack. Unit
green-yellow	2016-7607	20

End and intermediate plate; 1 mm thick

Color	Item No.	Pack. Unit
gray	2016-7691	100 (25)

Operating tool with a partially insulated shaft; Type 3; (5.5 x 0.8) mm blade

Item No.	Pack. Unit
210-721	1

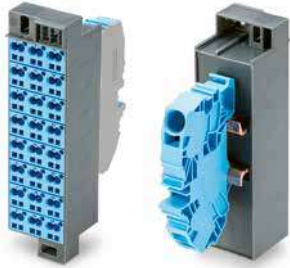
Technical DataSide 1: I_N 24 A24x 2x 0.08 ... 2.5 mm² | 28 ... 14 AWG 8 ... 10 mm / 0.31 ... 0.39 inchSide 2: I_N 76 A1x or 2x 0.5 ... 16 (25 "f-st") mm² | 20 ... 4 AWG 18 ... 20 mm / 0.71 ... 0.79 inch

① Suitable for Ex i applications

See application notes for:
Insulation stop, page 559Approvals and corresponding ratings,
visit www.wago.com**Accessories; for Common Potential Matrix Patchboards**Appropriate marking systems:
WMB/WMB Inline/Marking stripsInsulation stop; 0.08 ... 0.2 mm² "s" (0.14 mm² "f-st");
4 x 3 pcs/strip

	white	726-901	200 (25)
---	-------	---------	----------

Insulation stop; 0.25 mm² "s"; 0.14 ... 0.25 mm² "f-st";
4 x 3 pcs/strip

	light gray	726-906	200 (25)
---	------------	---------	----------

Insulation stop; 0.25 ... 0.5 mm² "s+f-st"; 4 x 3 pcs/strip

	dark gray	726-907	200 (25)
---	-----------	---------	----------

Wire commoning chain; insulated; 32 connections; I_N 6 A;
max. 50 V; 0.5 mm²

	gray	709-107	1
---	------	---------	---

Group marker carrier for side 2

	dark gray	726-902	50
---	-----------	---------	----

WMB marking card; white; 10 strips with 10 markers/card;
5 ... 5.2 mm stretchable

	plain	793-5501	5
---	-------	----------	---

WMB marking card; white; 10 strips with 10 markers/card;
horizontal marking

	1 ... 10 (10x)	793-5502	5
---	----------------	----------	---

WMB marking card; white; 10 strips with 10 markers/card;
horizontal marking

	1 ... 50 (2x)	793-5566	5
---	---------------	----------	---

WMB marking card; white; 10 strips with 10 markers/card;
horizontal marking

	X (100x)	793-5500/793-035	5
---	----------	------------------	---

WMB Inline; plain; 1,500 WMB markers (5 mm)/reel;
stretchable 5 ... 5.2 mm

	white	2009-115	1
---	-------	----------	---

Operating tool with a partially insulated shaft; Type 1; (2.5
x 0.4) mm blade

		210-719	1
---	--	---------	---

Common potential matrix patchboard; Dark gray frame;
Marking 1 ... 24; Blue modules; Vertical module marking;
with one supply terminal block incl. end plate; for 19"
racks; Slimline version

Item No.	Pack. Unit
726-631 ①	10

Common potential matrix patchboard; Dark gray frame;
Marking 1 ... 24; Blue modules; Vertical module marking;
with two supply terminal blocks incl. end plate; for 19"
racks; Slimline version

726-632 ①	10
-----------	----

Accessories; item-specificSpare supply terminal block; 2-conductor supply
terminal block for distribution boxes; only for use with
common potential matrix patchboards (726Series);
16 mm²; 12 mm wide

	blue	2016-7614	20
---	------	-----------	----

End and intermediate plate; 1 mm thick

	gray	2016-7691	100 (25)
---	------	-----------	----------

PUSH-IN CAGE CLAMP® CAGE CLAMP®

Common Potential Matrix Patchboard; Slimline Version; for 19" Racks; Supply Side/Patchboard Side

726 Series

Technical Data

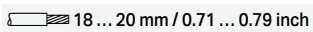
Side 1: I_N 76 A
 1x or 2x 0.5 ... 16 (25 "f-st") mm² | 20 ... 4 AWG
 18 ... 20 mm / 0.71 ... 0.79 inch

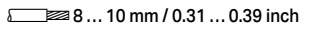
Side 2: I_N 24 A
 24x 2x 0.08 ... 2.5 mm² | 28 ... 14 AWG
 8 ... 10 mm / 0.31 ... 0.39 inch

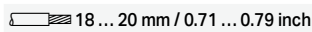

Technical Data

Side 1: I_N 76 A
 1x or 2x 0.5 ... 16 (25 "f-st") mm² | 20 ... 4 AWG
 18 ... 20 mm / 0.71 ... 0.79 inch

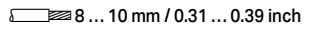
Side 2: I_N 24 A
 24x 2x 0.08 ... 2.5 mm² | 28 ... 14 AWG
 8 ... 10 mm / 0.31 ... 0.39 inch

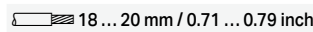

Technical Data

Side 1:
 1x or 2x 0.5 ... 16 (25 "f-st") mm² | 20 ... 4 AWG
 18 ... 20 mm / 0.71 ... 0.79 inch

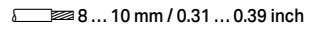
Side 2:
 24x 2x 0.08 ... 2.5 mm² | 28 ... 14 AWG
 8 ... 10 mm / 0.31 ... 0.39 inch



Dimensions in mm

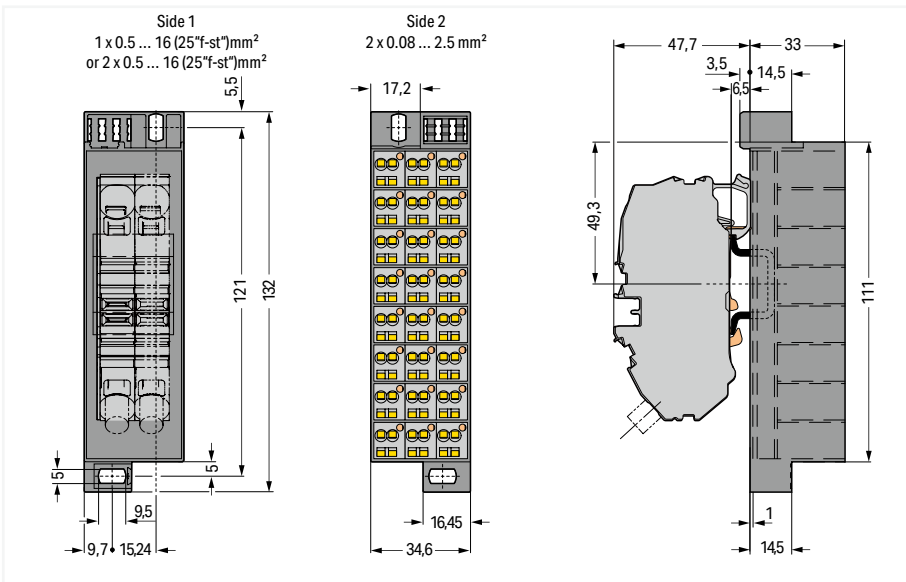

Common potential matrix patchboard; Dark gray frame; with one supply terminal block incl. end plate; Marking 1 ... 24; Gray modules; Vertical module marking; ; for 19" racks; Slimline version

Item No.	Pack. Unit
726-651	10

Common potential matrix patchboard; Dark gray frame; with one supply terminal block incl. end plate; Marking 1 ... 24; White modules; Vertical module marking; ; for 19" racks; Slimline version

Item No.	Pack. Unit
726-661	10

Common potential matrix patchboard; Dark gray frame; with one supply terminal block incl. end plate; Marking 1 ... 24; Green-yellow modules; Vertical module marking; ; for 19" racks; Slimline version

Item No.	Pack. Unit
726-671	10

12

Common potential matrix patchboard; Dark gray frame; with two supply terminal blocks incl. end plate; Marking 1 ... 24; Gray modules; Vertical module marking; for 19" racks; Slimline version

726-652	10
---------	----

Common Potential Matrix Patchboard; Dark gray frame; with two supply terminal blocks incl. end plate; Marking 1 ... 24; White modules; Vertical module marking; for 19" racks; Slimline version

726-662	10
---------	----

Common potential matrix patchboard; Dark gray frame; with two supply terminal blocks incl. end plate; Marking 1 ... 24; Green-yellow modules; Vertical module marking; for 19" racks; Slimline version

726-672	10
---------	----

Accessories; item-specific

Spare supply terminal block; only for use with common potential matrix patchboards (726Series); 16 mm²; 12 mm wide

Color	Item No.	Pack. Unit
gray	2016-7611	20



Accessories; item-specific

Spare supply terminal block; only for use with common potential matrix patchboards (726Series); 16 mm²; 12 mm wide

Color	Item No.	Pack. Unit
white	2016-7608	20



Accessories; item-specific

Ground supply terminal block; 2-conductor ground terminal block; 16 mm²; 12 mm wide

Color	Item No.	Pack. Unit
green-yellow	2016-7607	20



End and intermediate plate; 1 mm thick

Color	Item No.	Pack. Unit
gray	2016-7691	100 (25)



End and intermediate plate; 1 mm thick

Color	Item No.	Pack. Unit
gray	2016-7691	100 (25)



End and intermediate plate; 1 mm thick

Color	Item No.	Pack. Unit
gray	2016-7691	100 (25)



Operating tool with a partially insulated shaft; Type 3; (5.5 x 0.8) mm blade

Item No.	Pack. Unit
210-721	1



Operating tool with a partially insulated shaft; Type 3; (5.5 x 0.8) mm blade

Item No.	Pack. Unit
210-721	1



Operating tool with a partially insulated shaft; Type 3; (5.5 x 0.8) mm blade

Item No.	Pack. Unit
210-721	1



Matrix Patchboard; with Push-Buttons; Slimline Version; for 19" Racks; 32-Pole 726 Series

Technical Data

Side 1: 2x 0.2 ... 1.5 mm ² ①	24 ... 16 AWG
Side 2: 2x 0.2 ... 1.5 mm ² ①	24 ... 16 AWG
800 V / 8 kV / 3 ②	300 V, 10 A ③
I _N 10 A	300 V, 10 A ③

10 mm / 0.39 inch



Technical Data

Side 1: 2x 0.2 ... 1.5 mm ² ①	24 ... 16 AWG
Side 2: 2x 0.2 ... 1.5 mm ² ①	24 ... 16 AWG
800 V / 8 kV / 3 ②	300 V, 10 A ③
I _N 10 A	300 V, 10 A ③

10 mm / 0.39 inch

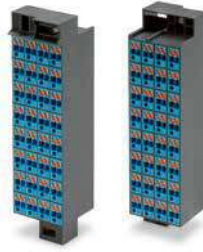

① Conductor range: 0.2 ... 1.5 mm² "s+f-st" and 0.25 ... 1 mm² "insulated ferrules; 10 mm"

② 800 V = rated voltage
8 kV = rated impulse voltage
3 = pollution degree (see Section 15)

③ Suitable for Ex i applications

See application notes for: Marking, from page 640

Approvals and corresponding ratings, visit www.wago.com

Accessories; for Matrix Patchboards

Appropriate marking systems: WMB/WMB Inline

Operating tool with a partially insulated shaft; Type 1; (2.5 x 0.4) mm blade

210-719 1



Test probe; 2 mm Ø; min. 12 mm lon; uninsulated tip; not offered by WAGO (e.g., MultiContact XPP-80/2-16)

Dimensions in mm

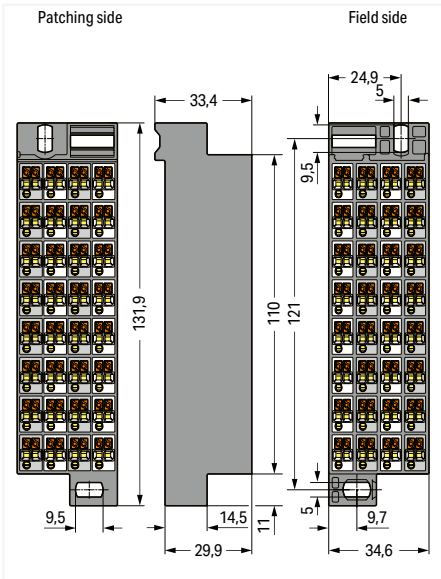

Matrix patchboard; Dark gray frame; Gray/white modules; for 19" racks; Slimline version; 32-pole

Marking	Item No.	Pack. Unit
plain	726-770	30

Matrix patchboard; Dark gray frame; Gray/white modules; Vertical module marking on sides 1 and 2; for 19" racks; Slimline version; 32-pole

1 ... 32	726-771	30
----------	---------	----

Matrix patchboard; Dark gray frame; White/gray modules; for 19" racks; Slimline version; 32-pole

plain	726-780	30
-------	---------	----

Dimensions in mm

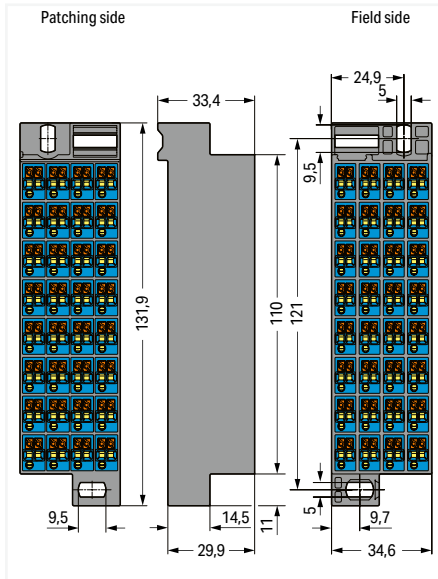

Matrix patchboard; Dark gray frame; Blue modules; for 19" racks; Slimline version; 32-pole

Marking	Item No.	Pack. Unit
plain	726-800 ③	30

Matrix patchboard; Dark gray frame; Blue modules; Vertical module marking on sides 1 and 2; for 19" racks; Slimline version; 32-pole

1 ... 32	726-801 ③	30
----------	-----------	----

Accessories; for Matrix Patchboards

Appropriate marking systems: WMB/WMB Inline

Wire commoning chain; insulated; 32 connections; I_N 6 A; max. 50 V; 0.5 mm²

gray	709-107	1
------	---------	---



WMB marker card; white; 10 strips with 10 markers/card; stretchable 5 ... 5.2 mm

plain	793-5501	5
-------	----------	---



WMB Inline; plain; 1,500 WMB markers (5 mm)/reel; stretchable 5 ... 5.2 mm

white	2009-115	1
-------	----------	---



Additional Module for Matrix Patchboards 726 Series

Technical Data

0.08 ... 4 mm ²	28 ... 14 AWG
0.08 ... 2.5 mm ²	28 ... 14 AWG
500 V / 6 kV / 3 ①	300 V, 10 A ②
I _N 10 A	
9 mm / 0.35 inch	

- ① 500 V = rated voltage
6 kV = rated impulse voltage
3 = pollution degree
(see Section 15)

See application notes for:
Insulation stop, page 559

Approvals and corresponding ratings,
visit www.wago.com



Dimensions in mm

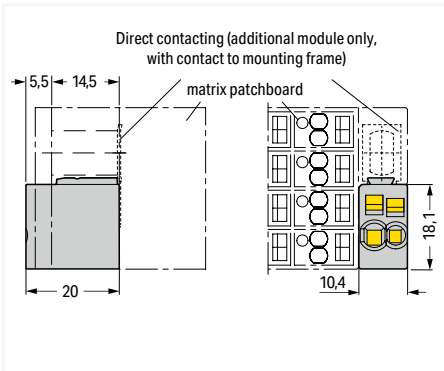

Additional module for matrix patchboard; for snap-on mounting to the lower mounting adapter; with CAGE CLAMP®; Additional module with contact to the mounting frame

Color	Item No.	Pack. Unit
○ white	726-903	25



Snapping on an additional module with contact to mounting frame.



Assembling a matrix patchboard with additional module – direct connection to the mounting frame.



Additional module for matrix patchboards; snaps onto the lower mounting adapter; with CAGE CLAMP®; insulated

Color	Item No.	Pack. Unit
○ gray	726-904	25

Insulation Stop; for Matrix Patchboard 726 Series

Suitable for patchboard side (side 1) of 1.5 mm² matrix patchboards (front side differs from back side)



Insulation stop; 0.08 ... 0.2 mm² "s" (0.14 mm² "f-st");
4 x 3 pcs/strip

Color	Item No.	Pack. Unit
○ white	726-901	200 (25)

Insulation stop; 0.25 mm² "s"; 0.14 ... 0.25 mm² "f-st";
4 x 3 pcs/strip

○ gray	726-906	200 (25)
--------	---------	----------

Insulation stop; 0.25 ... 0.5 mm² "s+f-st"; 4 x 3 pcs/strip

● dark gray	726-907	200 (25)
-------------	---------	----------



Inserting an insulation stop into conductor entry holes of matrix patchboards.



Mounted insulation stop

Terminal Blocks for Matrix Patching and Common Potential Terminal Blocks

727 Series

Description and Installation



Snap individual 4- or 8-level terminal blocks onto the DIN-rail.

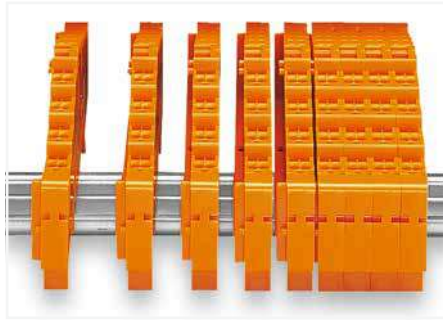

Slide terminal blocks together.

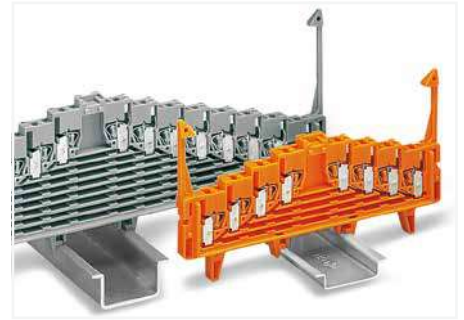

Terminal blocks for DIN-35 x 7.5 mm or DIN-35 x 15 mm rails are available.



Grip end plate at both sides and:

- push down (assembly)
- pull up (removal)

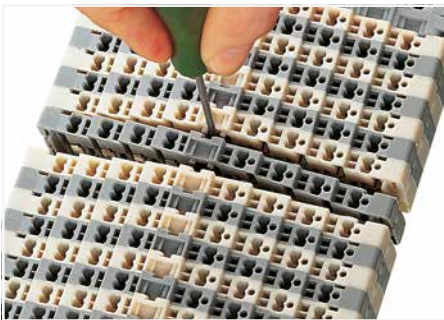

Open the assembly by laterally sliding a block via operating tool (2.5 x 0.4 mm blade).

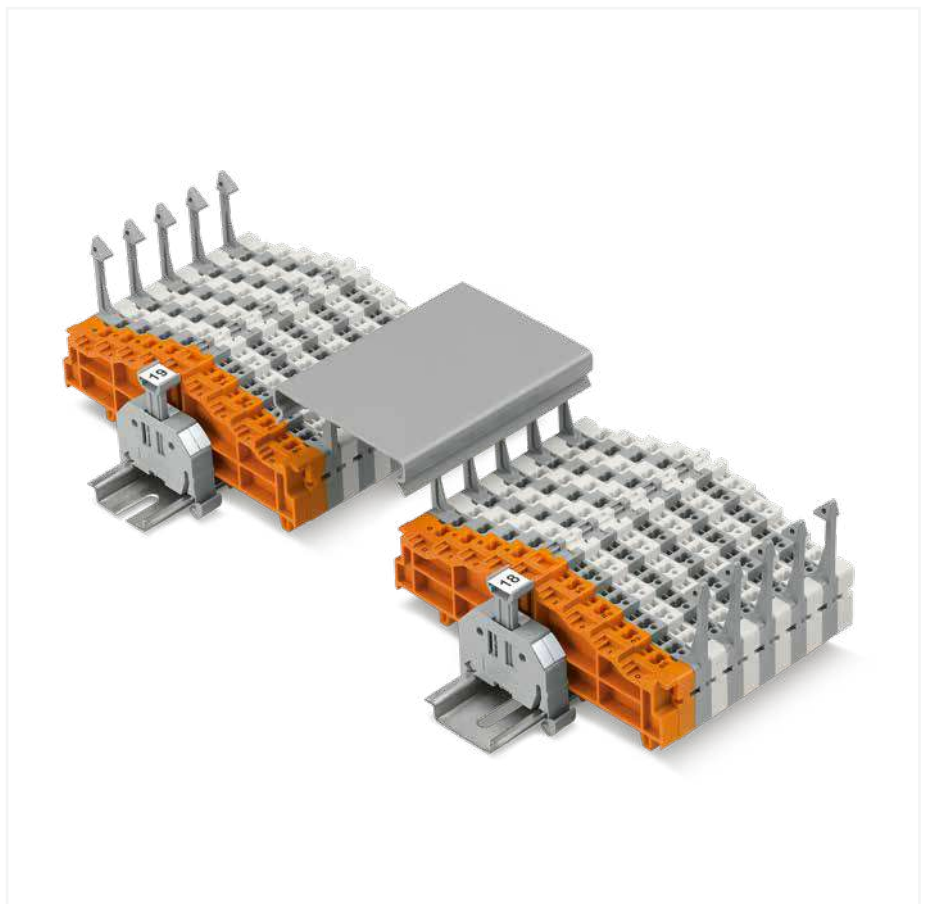

12



Slide terminal block and remove from the rail with a levering action.

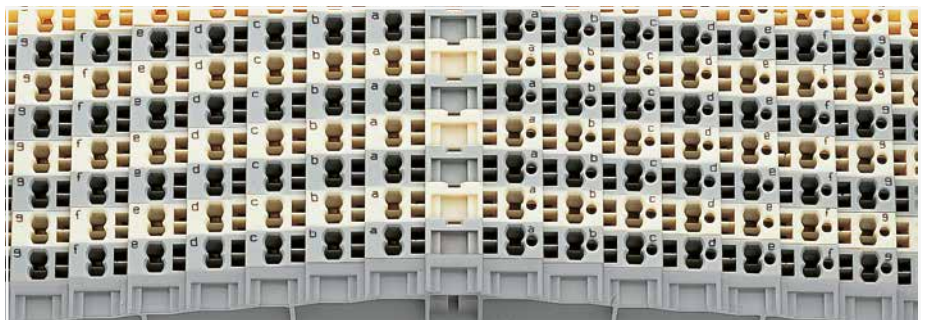

Connection points identified via factory-direct printing



CAGE CLAMP® terminates the following copper conductors: solid "s"



stranded "st"



fine-stranded "f-st", also with tinned single strands

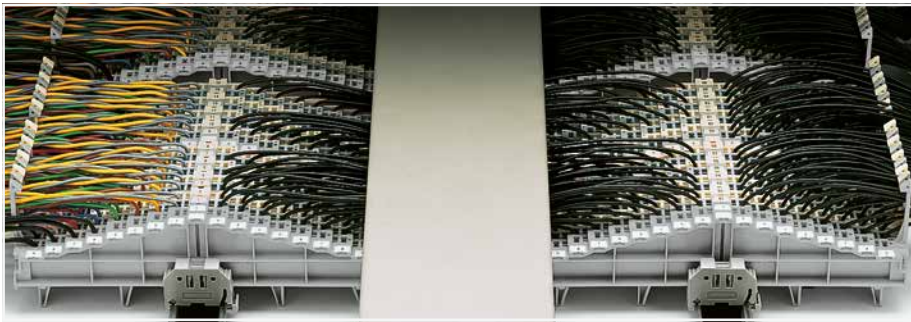

Example:
 Left: Main cables fed through locking clips on the field side
 Right: Control cables fed between locking clips
 Center: Wiring of both patching sides



Using terminal blocks with locking clips, the wiring space between the terminal strips can be covered with a wiring duct cover.

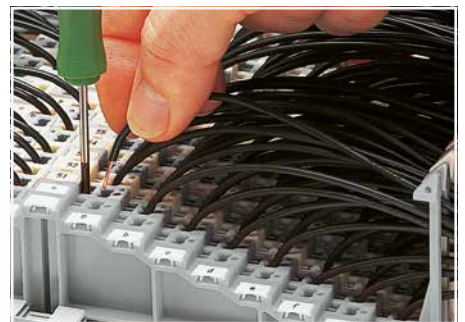
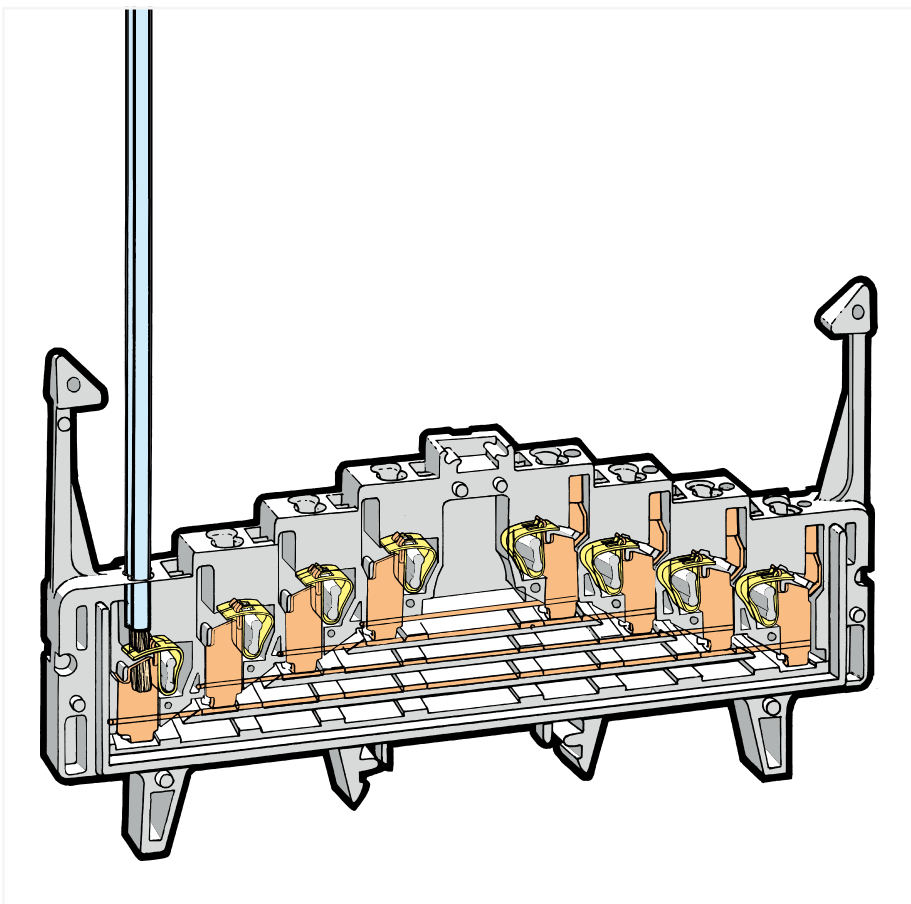

CAGE CLAMP® connection
 Inserting a conductor via 210-719 Operating Tool (2.5 x 0.4 mm blade).
 Max. cross section for uninsulated ferrules 1 mm² (18 AWG), for insulated ferrules 0.75 mm² (20 AWG)



Special test contact for step-down test plug; from 4 mm socket to 2 mm plug; max. 42 V

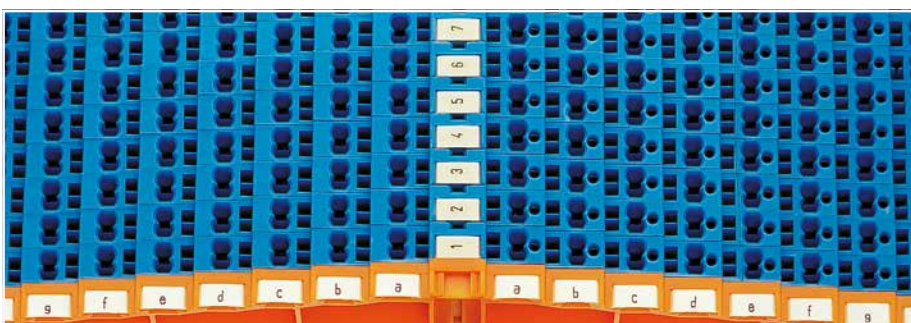

Marking coordinates via WMB Multi Marking System.

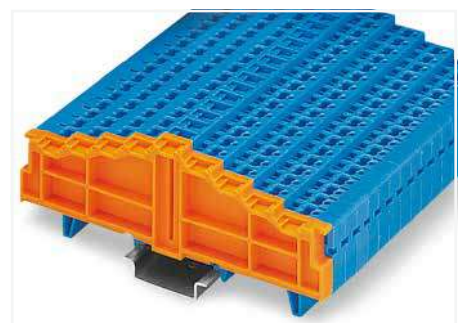

Blue terminal blocks for matrix patching are suitable for Ex i applications.



fine-stranded, tip-bonded



fine-stranded, with ferrule (gastight crimped)



fine-stranded, with pin terminal (gastight crimped)

4-Level Terminal Block for Matrix Patching

1.5 mm²; 727 Series

Technical Data	
0.08 ... 1.5 mm ²	28 ... 16 AWG
250 V / 4 kV / 3 ❶	300 V, 10 A ❷
I _N 12 A	300 V, 10 A ❸
Terminal block width: 7.62 mm / 0.3 inch	
8 ... 10 mm / 0.31 ... 0.39 inch	

Technical Data	
0.08 ... 1.5 mm ²	28 ... 16 AWG
250 V / 4 kV / 3 ❶	300 V, 10 A ❷
I _N 12 A	300 V, 10 A ❸
Terminal block width: 7.62 mm / 0.3 inch	
8 ... 10 mm / 0.31 ... 0.39 inch	

- ❶ 250 V = rated voltage
4 kV = rated impulse voltage
3 = pollution degree
(see Section 15)
 - ❷ Terminal blocks with a blue insulated housing are suitable for Ex i applications.
60 V = peak value ^ (table 4, EN 60079-11 when approved by the manufacturer's authorized inspection representative)
- See application notes for:
Wire harness support, page 567
Marking, from page 640
- Approvals and corresponding ratings, visit www.wago.com



4-level terminal block for matrix patching; with locking clips; no marking; 4 x pairs of clamping units on the same level; for DIN 35 x 7.5 rail

Color	Item No.	Pack. Unit
gray	727-219	50
white	727-221	50
blue	727-223 ❷	50

4-level terminal block for matrix patching; without locking clips; no marking; 4 x pairs of clamping units on the same level; for DIN 35 x 7.5 rail

Color	Item No.	Pack. Unit
gray	727-220	50
white	727-222	50
blue	727-224 ❷	50

4-level terminal block for matrix patching; with locking clips; no marking; 4 x pairs of clamping units on the same level; for DIN 35 x 15 rail

gray	727-229	50
white	727-231	50
blue	727-233 ❷	50

4-level terminal block for matrix patching; without locking clips; no marking; 4 x pairs of clamping units on the same level; for DIN 35 x 15 rail

gray	727-230	50
white	727-232	50
blue	727-234 ❷	50

Item no. suffixes for terminal blocks with marking:

0-1-2-3--3-2-1-0	.../021-000
a-b-c-d--d-c-b-a	.../022-000
3-2-1-0--0-1-2-3	.../023-000
d-c-b-a--a-b-c-d	.../024-000

Other terminal blocks with the same profile:

0-1-2-3--3-2-1-0	.../021-000
a-b-c-d--d-c-b-a	.../022-000
3-2-1-0--0-1-2-3	.../023-000
d-c-b-a--a-b-c-d	.../024-000

Accessories; 727 Series

Appropriate marking system: WMB

4-level end plate; no marking; 7.62 mm thick

orange	727-217	25
gray	727-213	25
blue	727-214	25

4-level end plate; Marking: 0-1-2-3--3-2-1-0; 7.62 mm thick

orange	727-205	25
gray	727-255	25
blue	727-265	25

4-level end plate; Marking: a-b-c-d--d-c-b-a; 7.62 mm thick

orange	727-206	25
gray	727-256	25
blue	727-266	25

4-level end plate; Marking: 3-2-1-0--0-1-2-3; 7.62 mm thick

orange	727-207	25
gray	727-257	25
blue	727-267	25

4-level end plate; Marking: d-c-b-a--a-b-c-d; 7.62 mm thick

orange	727-208	25
gray	727-258	25
blue	727-268	25

Insulation stop; 0.08 ... 0.2 mm² "s" (0.14 mm² "f-st"); 8 pcs/strip

white	727-197	200 (25)
-------	---------	----------

Insulation stop; 0.25 mm² "s"; 0.14 ... 0.25 mm² "f-st"; 8 pcs/strip

light gray	727-198	200 (25)
------------	---------	----------

Insulation stop; 0.25 ... 0.5 mm² "s+f-st"; 8 pcs/strip

dark gray	727-199	200 (25)
-----------	---------	----------

Wire commoning chain; insulated; 32 connections; I_N 6 A; max. 50 V; 0.5 mm²

gray	709-107	1
------	---------	---

Step-down test plug; from 4 mm socket to 2 mm plug; max. 42 V

red	210-297	100 (25)
-----	---------	----------

Accessories; 727 Series

Appropriate marking systems:
WMB

Wire harness support

	gray	249-109	50
--	------	---------	----

Double marker carrier; for center I/O module marking; for WSB and WMB marking systems; 4 mm wide

	gray	209-128	200 (100)
--	------	---------	-----------

Operating tool with a partially insulated shaft; Type 1; (2.5 x 0.4) mm blade

		210-719	1
--	--	---------	---

12

4-Level Common Potential Terminal Block

1.5 mm²; 727 Series

Technical Data	
0.08 ... 1.5 mm ²	28 ... 16 AWG
250 V / 4 kV / 3 ①	300 V, 10 A
I _N 18 A	300 V, 10 A
Terminal block width: 7.62 mm / 0.3 inch	
8 ... 10 mm / 0.31 ... 0.39 inch	

Technical Data	
0.08 ... 1.5 mm ²	28 ... 16 AWG
250 V / 4 kV / 3 ①	300 V, 10 A
I _N 18 A	300 V, 10 A
Terminal block width: 7.62 mm / 0.3 inch	
8 ... 10 mm / 0.31 ... 0.39 inch	

- ① 250 V = rated voltage
4 kV = rated impulse voltage
3 = pollution degree
(see Section 15)
- See application notes for:
Wire harness support, page 567
Marking, from page 640
- Approvals and corresponding ratings,
visit www.wago.com

Accessories; 727 Series
Appropriate marking systems:
WMB

Operating tool with a partially insulated shaft; Type 1; (2.5 x 0.4) mm blade



210-719 1

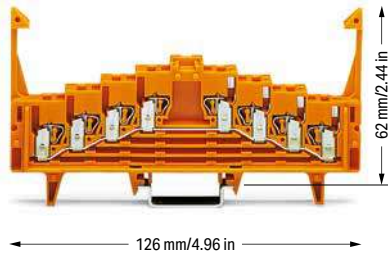

4-level common potential terminal block; with locking clips; no marking; all clamping units connected to the same current bar; for DIN 35 x 7.5 rail

Color	Item No.	Pack. Unit
orange	727-225	50
light gray	727-227	50

4-level terminal block for matrix patching; without locking clips; no marking; all clamping units connected to the same current bar; for DIN 35 x 7.5 rail

Color	Item No.	Pack. Unit
orange	727-226	50
light gray	727-228	50

4-level common potential terminal block; with locking clips; no marking; all clamping units connected to the same current bar; for DIN 35 x 15 rail

orange	727-235	50
light gray	727-237	50

4-level terminal block for matrix patching; without locking clips; no marking; all clamping units connected to the same current bar; for DIN 35 x 15 rail

orange	727-236	50
light gray	727-238	50

Item no. suffixes for terminal blocks with marking:

0-1-2-3--3-2-1-0	.../021-000
a-b-c-d--d-c-b-a	.../022-000
3-2-1-0--0-1-2-3	.../023-000
d-c-b-a--a-b-c-d	.../024-000

Other terminal blocks with the same profile:

0-1-2-3--3-2-1-0	.../021-000
a-b-c-d--d-c-b-a	.../022-000
3-2-1-0--0-1-2-3	.../023-000
d-c-b-a--a-b-c-d	.../024-000

Accessories; 727 Series
Appropriate marking system: WMB

4-level end plate; no marking; 7.62 mm thick

orange	727-217	25
gray	727-213	25

Insulation stop; 0.25 mm² "s"; 0.14 ... 0.25 mm² "f-st"; 8 pcs/strip

light gray	727-198	200 (25)
------------	---------	----------

4-level end plate; Marking: 0-1-2-3--3-2-1-0; 7.62 mm thick

orange	727-205	25
gray	727-255	25

Insulation stop; 0.25 ... 0.5 mm² "s+f-st"; 8 pcs/strip

dark gray	727-199	200 (25)
-----------	---------	----------

4-level end plate; Marking: a-b-c-d--d-c-b-a; 7.62 mm thick

orange	727-206	25
gray	727-256	25

Wire commoning chain; insulated; 32 connections; I_N 6 A; max. 50 V; 0.5 mm²

gray	709-107	1
------	---------	---

4-level end plate; Marking: 3-2-1-0--0-1-2-3; 7.62 mm thick

orange	727-207	25
gray	727-257	25

Step-down test plug; from 4 mm socket to 2 mm plug; max. 42 V

red	210-297	100 (25)
-----	---------	----------

4-level end plate; Marking: d-c-b-a--a-b-c-d; 7.62 mm thick

orange	727-208	25
gray	727-258	25

Wire harness support

gray	249-109	50
------	---------	----

Insulation stop; 0.08 ... 0.2 mm² "s" (0.14 mm² "f-st"); 8 pcs/strip

white	727-197	200 (25)
-------	---------	----------

Double marker carrier; for center I/O module marking; for WSB and WMB marking systems; 4 mm wide

gray	209-128	200 (100)
------	---------	-----------

8-Level Terminal Block for Matrix Patching

1.5 mm²; 727 Series

Technical Data	
0.08 ... 1.5 mm ²	28 ... 16 AWG
250 V / 4 kV / 3 ①	300 V, 10 A
I _N 10 A	300 V, 10 A
Terminal block width: 7.62 mm / 0.3 inch	
8 ... 10 mm / 0.31 ... 0.39 inch	

Technical Data	
0.08 ... 1.5 mm ²	28 ... 16 AWG
250 V / 4 kV / 3 ①	300 V, 10 A
I _N 10 A	300 V, 10 A
Terminal block width: 7.62 mm / 0.3 inch	
8 ... 10 mm / 0.31 ... 0.39 inch	



8-level terminal block for matrix patching; with locking clips; no marking; 8 x pairs of clamping units on the same level; for DIN 35 x 7.5 rail

Color	Item No.	Pack. Unit
gray	727-119	25
white	727-121	25
blue	727-123 ②	25

8-level terminal block for matrix patching; without locking clips; no marking; 8 x pairs of clamping units on the same level; for DIN 35 x 7.5 rail

Color	Item No.	Pack. Unit
gray	727-120	25
white	727-122	25
blue	727-124 ②	25

8-level terminal block for matrix patching; with locking clips; no marking; 8 x pairs of clamping units on the same level; for DIN 35 x 15 rail

Color	Item No.	Pack. Unit
gray	727-129	25
white	727-131	25
blue	727-133 ②	25

8-level terminal block for matrix patching; without locking clips; no marking; 8 x pairs of clamping units on the same level; for DIN 35 x 15 rail

Color	Item No.	Pack. Unit
gray	727-130	25
white	727-132	25
blue	727-134 ②	25

Item no. suffixes for terminal blocks with marking:

0-1-2-3-4-5-6-7--7-6-5-4-3-2-1-0	.../001-000
a-b-c-d-e-f-g-h--h-g-f-e-d-c-b-a	.../002-000
7-6-5-4-3-2-1-0--0-1-2-3-4-5-6-7	.../003-000
h-g-f-e-d-c-b-a--a-b-c-d-e-f-g-h	.../004-000

Other terminal blocks with the same profile:

0-1-2-3-4-5-6-7--7-6-5-4-3-2-1-0	.../001-000
a-b-c-d-e-f-g-h--h-g-f-e-d-c-b-a	.../002-000
7-6-5-4-3-2-1-0--0-1-2-3-4-5-6-7	.../003-000
h-g-f-e-d-c-b-a--a-b-c-d-e-f-g-h	.../004-000

Accessories; 727 Series

Appropriate marking system: WMB

8-level end plate; no marking; 7.62 mm thick

orange	727-117	25
gray	727-113	25
blue	727-114	25
white	727-115	25
light gray	727-116	25

8-level end plate; Marking: 7-6-5-4-3-2-1-0--0-1-2-3-4-5-6-7; 7.62 mm thick

orange	727-107	25
gray	727-157	25
blue	727-161	25
white	727-165	25
light gray	727-169	25

8-level end plate; Marking: 0-1-2-3-4-5-6-7--7-6-5-4-3-2-1-0; 7.62 mm thick

orange	727-105	25
gray	727-155	25
blue	727-159	25
white	727-163	25
light gray	727-167	25

8-level end plate; Marking: h-g-f-e-d-c-b-a--a-b-c-d-e-f-g-h; 7.62 mm thick

orange	727-108	25
gray	727-158	25
blue	727-162	25
white	727-166	25
light gray	727-170	25

8-level end plate; Marking: a-b-c-d-e-f-g-h--h-g-f-e-d-c-b-a; 7.62 mm thick

orange	727-106	25
gray	727-156	25
blue	727-160	25
white	727-164	25
light gray	727-168	25

Insulation stop; 0.08 ... 0.2 mm² "s" (0.14 mm² "f-st"); 8 pcs/strip

white	727-197	200 (25)
-------	---------	----------

Insulation stop; 0.25 mm² "s"; 0.14 ... 0.25 mm² "f-st"; 8 pcs/strip

light gray	727-198	200 (25)
------------	---------	----------

① 250 V = rated voltage
4 kV = rated impulse voltage
3 = pollution degree
(see Section 15)

② Terminal blocks with a blue insulated housing are suitable for Ex i applications.
60 V = peak value ^ (table 4, EN 60079-11 when approved by the manufacturer's authorized inspection representative

See application notes for:
Wire harness support, page 567
Marking, from page 640

Note: Only combine terminal blocks and end plates that are colored **gray/white/light gray** or **orange/blue!**

Approvals and corresponding ratings, visit www.wago.com

Accessories; 727 Series

Appropriate marking systems:
WMB

Insulation stop; 0.25 ... 0.5 mm² "s+f-st"; 8 pcs/strip

dark gray	727-199	200 (25)
-----------	---------	----------

Wire commoning chain; insulated; 32 connections; I_N 6 A; max. 50 V; 0.5 mm²

gray	709-107	1
------	---------	---

Step-down test plug; from 4 mm socket to 2 mm plug; max. 42 V

red	210-297	100 (25)
-----	---------	----------

Wire harness support

gray	249-109	50
------	---------	----

Double marker carrier; for center I/O module marking; for WSB and WMB marking systems; 4 mm wide

gray	209-128	200 (100)
------	---------	-----------

WMB marker card; white; 10 strips with 10 markers/card; for PLC input marking; for 5 ... 17.5 mm terminal block width

E0.0, E0.1, ..., E9.6, E9.7 (1x each)	793-933	5
---------------------------------------	---------	---

Operating tool with a partially insulated shaft; Type 1; (2.5 x 0.4) mm blade

operating tool	210-719	1
----------------	---------	---

8-Level Common Potential Terminal Block

1.5 mm²; 727 Series

Technical Data	
0.08 ... 1.5 mm ²	28 ... 16 AWG
250 V / 4 kV / 3 ①	300 V, 10 A ②
I _N 18 A	300 V, 10 A ③
Terminal block width: 7.62 mm / 0.3 inch	
8 ... 10 mm / 0.31 ... 0.39 inch	

Technical Data	
0.08 ... 1.5 mm ²	28 ... 16 AWG
250 V / 4 kV / 3 ①	300 V, 10 A ②
I _N 18 A	300 V, 10 A ③
Terminal block width: 7.62 mm / 0.3 inch	
8 ... 10 mm / 0.31 ... 0.39 inch	

- ① 250 V = rated voltage
4 kV = rated impulse voltage
3 = pollution degree
(see Section 15)

See application notes for:
Wire harness support, page 567
Marking, from page 640

Note: Only combine terminal blocks and end plates that are colored **gray/white/light gray or orange/blue!**

Approvals and corresponding ratings, visit www.wago.com

Accessories; 727 Series

Appropriate marking systems:
WMB

Step-down test plug; from 4 mm socket to 2 mm plug; max. 42 V

	red	210-297	100 (25)
---	-----	---------	----------

Wire harness support

	gray	249-109	50
---	------	---------	----

Double marker carrier; for center I/O module marking; for WSB and WMB marking systems; 4 mm wide

	gray	209-128	200 (100)
--	------	---------	-----------

Operating tool with a partially insulated shaft; Type 1; (2.5 x 0.4) mm blade

		210-719	1
---	--	---------	---

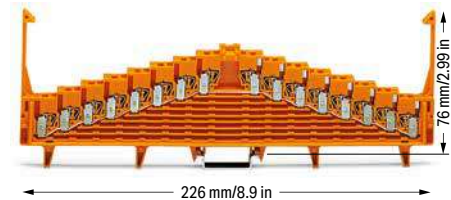

8-level common potential terminal block; with locking clips; no marking; all clamping units connected to the same current bar; for DIN 35 x 7.5 rail

Color	Item No.	Pack. Unit
orange	727-125	25
light gray	727-127	25

8-level terminal block for matrix patching; without locking clips; no marking; all clamping units connected to the same current bar; for DIN 35 x 7.5 rail

Color	Item No.	Pack. Unit
orange	727-126	25
light gray	727-128	25

8-level common potential terminal block; with locking clips; no marking; all clamping units connected to the same current bar; for DIN 35 x 15 rail

orange	727-135	25
light gray	727-137	25

8-level terminal block for matrix patching; without locking clips; no marking; all clamping units connected to the same current bar; for DIN 35 x 15 rail

orange	727-136	25
light gray	727-138	25

Item no. suffixes for terminal blocks with marking:

0-1-2-3-4-5-6-7--7-6-5-4-3-2-1-0	.../001-000
a-b-c-d-e-f-g-h--h-g-f-e-d-c-b-a	.../002-000
7-6-5-4-3-2-1-0--0-1-2-3-4-5-6-7	.../003-000
h-g-f-e-d-c-b-a--a-b-c-d-e-f-g-h	.../004-000

Other terminal blocks with the same profile:

0-1-2-3-4-5-6-7--7-6-5-4-3-2-1-0	.../001-000
a-b-c-d-e-f-g-h--h-g-f-e-d-c-b-a	.../002-000
7-6-5-4-3-2-1-0--0-1-2-3-4-5-6-7	.../003-000
h-g-f-e-d-c-b-a--a-b-c-d-e-f-g-h	.../004-000

Accessories; 727 Series

Appropriate marking system: WMB

8-level end plate; no marking; 7.62 mm thick

	orange	727-117	25
	gray	727-113	25
	blue	727-114	25
	white	727-115	25
	light gray	727-116	25

8-level end plate; Marking: h-g-f-e-d-c-b-a--a-b-c-d-e-f-g-h; 7.62 mm thick

	orange	727-108	25
	gray	727-158	25
	blue	727-162	25
	white	727-166	25
	light gray	727-170	25

8-level end plate; Marking: 0-1-2-3-4-5-6-7--7-6-5-4-3-2-1-0; 7.62 mm thick

	orange	727-105	25
	gray	727-155	25
	blue	727-159	25
	white	727-163	25
	light gray	727-167	25

Insulation stop; 0.08 ... 0.2 mm² "s" (0.14 mm² "f-st"); 8 pcs/strip

	white	727-197	200 (25)
---	-------	---------	----------

8-level end plate; Marking: a-b-c-d-e-f-g-h--h-g-f-e-d-c-b-a; 7.62 mm thick

	orange	727-106	25
	gray	727-156	25
	blue	727-160	25
	white	727-164	25
	light gray	727-168	25

Insulation stop; 0.25 mm² "s"; 0.14 ... 0.25 mm² "f-st"; 8 pcs/strip

	light gray	727-198	200 (25)
---	------------	---------	----------

8-level end plate; Marking: 7-6-5-4-3-2-1-0--0-1-2-3-4-5-6-7; 7.62 mm thick

	orange	727-107	25
	gray	727-157	25
	blue	727-161	25
	white	727-165	25
	light gray	727-169	25

Insulation stop; 0.25 ... 0.5 mm² "s+f-st"; 8 pcs/strip

	dark gray	727-199	200 (25)
---	-----------	---------	----------

Wire commoning chain; insulated; 32 connections; I_N 6 A; max. 50 V; 0.5 mm²

	gray	709-107	1
---	------	---------	---

Terminal Blocks for Matrix Patching

280 Series

Description and Installation



Terminal blocks for matrix patching:
Inserting/removing a conductor on the terminal block's side-entry.
With ferruled conductors, it is necessary to use a terminal block one size smaller than the conductor's nominal cross section.



Terminal blocks for matrix patching:
Inserting/removing a conductor in the terminal block's center.



Using terminal blocks for matrix patching as disconnect terminal blocks via disconnect jumpers.



Multiplying potentials via 10-way comb-style jumper bar. (only possible in the terminal block's center)



Separator for 3-conductor, double-potential terminal blocks (280-675)

CAGE CLAMP® terminates the following copper conductors:
solid "s" stranded "st"

fine-stranded "f-st", also with tinned single strands

fine-stranded, tip-bonded

fine-stranded, with ferrule (gastight crimped)

fine-stranded, with pin terminal (gastight crimped)

Terminal Block for Matrix Patching

2.5 mm²; 280 Series

Technical Data

0.08 ... 2.5 mm ²	28 ... 12 AWG*
800 V / 8 kV / 3 ①	600 V, 10 A ②
I _N 18 A	
Terminal block width: 5 mm / 0.197 inch	
8 ... 9 mm / 0.31 ... 0.35 inch	

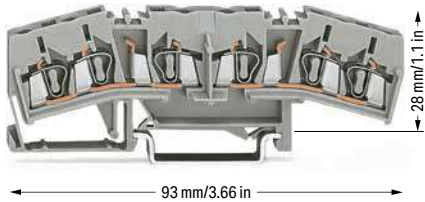

3-conductor double-potential terminal block or terminal block for matrix patching
 Notice: This 3-conductor double-potential terminal block cannot be commoned via adjacent jumpers.

Color	Item No.	Pack. Unit
○ gray	280-675	100

Accessories; for Terminal Blocks for Matrix Patching

Appropriate marking systems:
WMB/WMB Inline

End and intermediate plate; 25 mm thick

 orange	280-333	25
 gray	280-325	25

Separator; 3 mm oversized; 1 mm thick

 gray	280-394	100 (25)
 orange	280-395	100 (25)

Insulation stop; 0.08 ... 0.2 mm² "s" (0.14 mm² "f-st"); 5 pcs/strip

 white	280-470	200 (25)
---	---------	----------

Insulation stop; 0.25 ... 0.5 mm²; 5 pcs/strip

 light gray	280-471	200 (25)
--	---------	----------

Insulation stop; 0.75 ... 1 mm²; 5 pcs/strip

 dark gray	280-472	200 (25)
---	---------	----------

Protective warning marker; with black high-voltage symbol; for 5 terminal blocks

 yellow	280-415	100 (25)
--	---------	----------

Comb-style jumper bar; insulated; I_N = I_N of terminal block

 2-way	280-482	200 (25)
 3-way	280-483	200 (25)

Comb-style jumper bar; insulated; I_N = I_N of terminal block

 10-way	280-490	50 (25)
--	---------	---------

Disconnect jumper; with pull-tab; I_N = I_N of terminal block; orange

 2-way	280-494	200 (25)
---	---------	----------

*12 AWG: THHN, THWN

- ① 800 V = rated voltage
 8 kV = rated impulse voltage
 3 = pollution degree (see Section 15)
 500 V / 6 kV / 3 between both current bars (if used as disconnect terminal block or potential multiplier)

See application notes for:
 Insulation stop, page 382
 Comb-style jumper bar, page 384
 Marking, from page 640

Approvals and corresponding ratings, visit www.wago.com

Accessories; for Terminal Blocks for Matrix Patching

Appropriate marking systems:
WMB/WMB Inline

Operating tool; insulated

 2-way	280-432	1
 3-way	280-433	1

Operating tool; insulated

 10-way	280-440	1
--	---------	---

For 5 mm wide double-potential terminal blocks, two 3-conductor through terminal blocks are offered in one insulating housing on one level. This achieves a width of just 2.5 mm versus standard through terminal blocks. On each side of the terminal block are marker slots for WAGO WMB Inline markers. Via the available accessories, these terminal blocks can also be used as 4-conductor disconnect terminal blocks or potential multipliers.

Busbar Terminal Block

4 mm² and 16 mm²; 812 Series

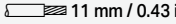
Technical Data	
0.5 ... 4 mm²	20 ... 12 AWG
1000 V / 6 kV / 3	600 V, 20 A VA
I _N 96 A	600 V, 95 A A@
Terminal block width: 75 mm / 2.953 inch	
 11 mm / 0.43 inch	

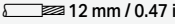
Technical Data	
1.5 ... 16 mm²	14 ... 6 AWG
1000 V / 6 kV / 3	600 V, 20 A VA
I _N 96 A	600 V, 95 A A@
Terminal block width: 38 mm / 1.496 inch	
 12 mm / 0.47 inch	

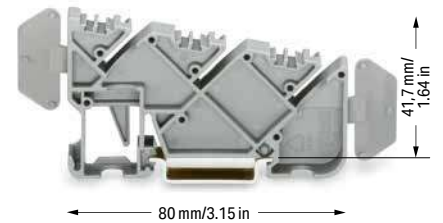
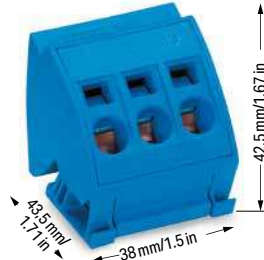



Busbar terminal block 4 mm²; with Push-in CAGE CLAMP® connection		
Color	Item No.	Pack. Unit
● blue	812-104	10
○ light gray	812-101	10
● dark gray	812-102	10
● red	812-103	10

Busbar terminal block 16 mm²; with CAGE CLAMP® connection		
Color	Item No.	Pack. Unit
● blue	812-114	12
○ light gray	812-111	12
● dark gray	812-112	12
● red	812-113	12

Insulated busbar carrier; 12 mm wide		
Color	Item No.	Pack. Unit
○ gray	812-140	25

Accessories; item-specific			
Busbar; tin-plated; 1000 mm long; Copper (10 x 3) mm			
I _N	Item No.	Pack. Unit	
140 A	210-133	1	

Accessories; item-specific			
Busbar; tin-plated; 1000 mm long; Copper (10 x 3) mm			
I _N	Item No.	Pack. Unit	
140 A	210-133	1	

Finger guard; touch-proof cover protects unused conductor entries			
Color	Item No.	Pack. Unit	
yellow	284-400	100 (25)	

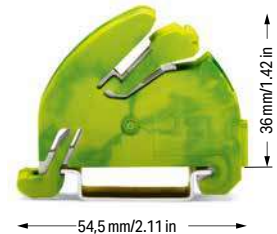
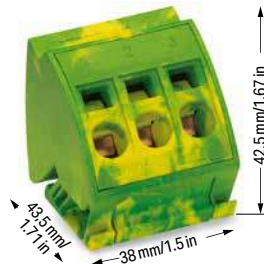
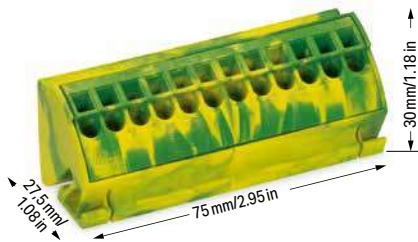



Ground busbar terminal block 4 mm²; with Push-in CAGE CLAMP® connection		
Color	Item No.	Pack. Unit
● green-yellow	812-100	10

Ground busbar terminal block 16 mm²; with CAGE CLAMP® connection		
Color	Item No.	Pack. Unit
● green-yellow	812-110	12

Ground busbar carrier; with DIN-35 rail contact; 11 mm wide		
Color	Item No.	Pack. Unit
● green-yellow	812-141	25

Accessories; item-specific			
Busbar; tin-plated; 1000 mm long; Copper (10 x 3) mm			
I _N	Item No.	Pack. Unit	
140 A	210-133	1	

Accessories; item-specific			
Busbar; tin-plated; 1000 mm long; Copper (10 x 3) mm			
I _N	Item No.	Pack. Unit	
140 A	210-133	1	













Finger guard; touch-proof cover protects unused conductor entries			
Color	Item No.	Pack. Unit	
yellow	284-400	100 (25)	



WAGO Splicing Connectors
WAGO Lighting Connectors

WAGO Splicing Connectors

WAGO Lighting Connectors

			Page
	COMPACT PUSH WIRE® Connectors for Junction Boxes 2.5 mm ² (14 AWG)	2273 Series	615
	PUSH WIRE® Connectors for Junction Boxes 4 mm ² and 6 mm ² (10 AWG)	773 Series	618
	Ex PUSH WIRE® Connectors for Junction Boxes 2.5 mm ² (12 AWG) and 6 mm ² (10 AWG)	773 Series	620
	MICRO PUSH WIRE® Connectors for Junction Boxes 0.8 mm Ø	243 Series	624
	COMPACT Splicing Connectors for All Conductor Types 4 mm ² and 6 mm ² (10 AWG)	221 Series	627
	COMPACT Splicing Connector for All Conductor Types; for Ex eb Applications 4 mm ² and 6 mm ² (10 AWG)	221 Series	636
	Gelbox; for Splicing Connectors	207 Series	641
	Inline Splicing Connectors 4 mm ² (14 AWG)	221 Series	647
	Gelbox; for Inline Splicing Connectors	207 Series	651
	CLASSIC Splicing Connectors for All Conductor Types 2.5 mm ² (14 AWG)	222 Series	653
	Lighting Connectors 2.5 mm ² (14 AWG)	224 Series	657
	Connector Sets	887 Series	658
	Luminaire Disconnect Connectors 12 AWG	873 Series	662

COMPACT Splicing Connectors for Solid Conductors

2273 Series

Description and Installation

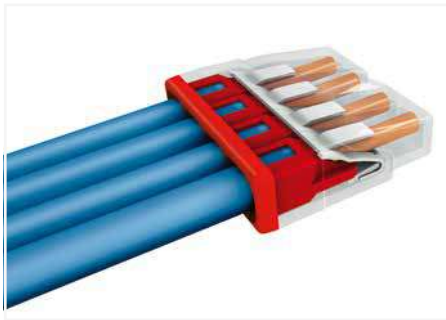

Advantages:

- Convenient wiring via extremely compact design
- Push-in termination of up to eight solid conductors
- Cross section range: 0.5 ... 2.5 mm² (18 ... 14 AWG)
- Any combination of conductor sizes is possible
- PUSH WIRE® connection terminates solid ("s") copper conductors



Strip solid conductor to 11 mm/0.43 inch (see marking).

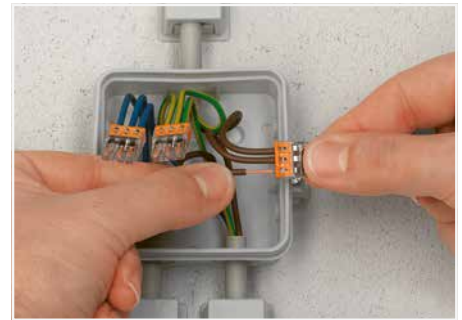

Termination: Insert the stripped solid conductor until it hits backstop.

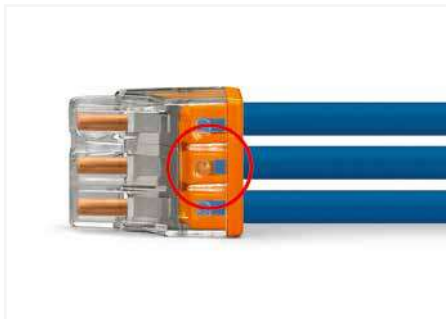

The transparent housing shows if conductors are fully inserted; within the colored base, a clear port shows if the conductor's strip length is correct. Conductors are correctly stripped if the clear port shows no bare conductor on the unprinted connector side. Picture shows center conductor with exceeded strip length.



Removal: Hold conductor to be removed and twist alternately left and right while pulling the connector.



Testing via test port opposite to conductor entry.



One single carrier can hold up to 24 clamping units in a very narrow space. Previously, this was only possible using rail-mount terminal blocks.

Advantages:

- Mount carrier onto DIN-35 rail or via screws – easily and quickly
- Accommodate three 2.5 mm² (12 AWG) 2273 Series Connectors in a single carrier
- Easily exchange connectors
- Large marking area for self-adhesive marking strips or for direct marking with permanent felt-tip pen

PUSH WIRE® Connectors in Distribution Boxes

During distribution box retrofits or expansions, conductors often require extensions or additional clamping points. Individual PUSH WIRE® connectors (e.g., 2273 Series) are approved as interconnect components for building wiring applications per EN 60998. Application standards for building installation (e.g., Parts 510 and 520 from DIN VDE 0100) also place the following requirements on junction box connectors:

- They must be arranged so that operation, inspection, maintenance and access to the removable connectors is simplified.
- It must be possible to test them.
- Conductors connected from outside must be clearly and permanently assigned to their associated circuits.



To adjust the mounting carrier, unlock the latch via operating tool (5.5 mm blade) and move the clamping slide to the required width by rotating the tool.



The mounting carrier is suitable for both connector widths.

These requirements cannot be met with PUSH WIRE® connectors alone. In combination with mounting carriers, the PUSH WIRE® connectors clearly meet these requirements, making them comparable to rail-mount terminal blocks. Using PUSH WIRE® connectors with mounting carriers in distribution boxes is accepted by testing authorities.



PUSH WIRE® terminates the following copper conductors: solid "s"

COMPACT Splicing Connector for Solid Conductors and Mounting Carrier

2.5 mm²; 2273 Series

Technical Data	
0.5 ... 2.5 mm ² "s"	20 ... 16 AWG "s"
450 V / 4 kV / 2	600 V, 20 A [Ⓢ]
I _N 24 A	
□ 11 mm / 0.43 inch	



Dimensions in mm

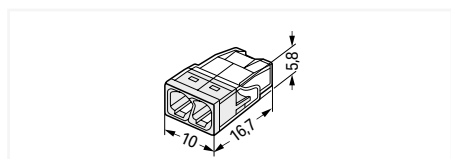

COMPACT splicing connector; 2-wire connector; transparent housing; white cover; continuous operating temperature (max.): 105 °C; surrounding air temperature (max.): 60 °C (T60)

Item No.	Pack. Unit
2273-202	1000 (100)

Technical Data	
0.5 ... 2.5 mm ² "s"	20 ... 16 AWG "s"
450 V / 4 kV / 2	600 V, 20 A [Ⓢ]
I _N 24 A	
□ 11 mm / 0.43 inch	



Dimensions in mm

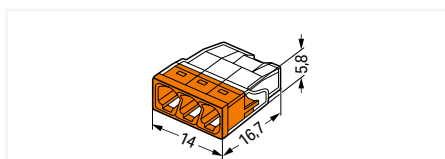

COMPACT splicing connector; 3-wire connector; transparent housing; orange cover; continuous operating temperature (max.): 105 °C; surrounding air temperature (max.): 60 °C (T60)

Item No.	Pack. Unit
2273-203	1000 (100)

Technical Data	
0.5 ... 2.5 mm ² "s"	20 ... 16 AWG "s"
450 V / 4 kV / 2	600 V, 20 A [Ⓢ]
I _N 24 A	
□ 11 mm / 0.43 inch	



Dimensions in mm

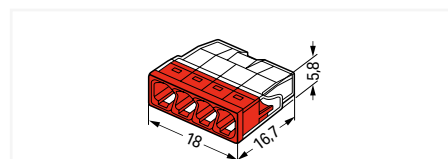

COMPACT splicing connector; 4-wire connector; transparent housing; red cover; continuous operating temperature (max.): 105 °C; surrounding air temperature (max.): 60 °C (T60)

Item No.	Pack. Unit
2273-204	1000 (100)



Dimensions in mm

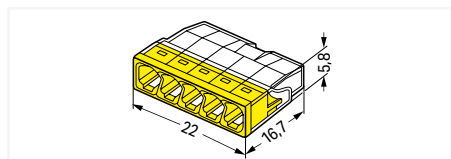

COMPACT splicing connector; 5-wire connector; transparent housing; yellow cover; continuous operating temperature (max.): 105 °C; surrounding air temperature (max.): 60 °C (T60)

Item No.	Pack. Unit
2273-205	1000 (100)



Dimensions in mm

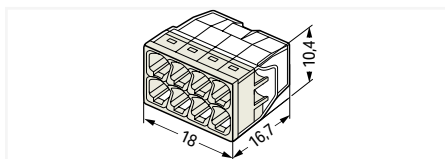

COMPACT splicing connector; 8-wire connector; transparent housing; light gray cover; continuous operating temperature (max.): 105 °C; surrounding air temperature (max.): 60 °C (T60)

Item No.	Pack. Unit
2273-208	500 (50)

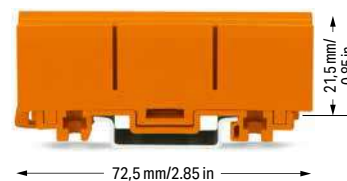

Mounting carrier; for single- and double-row connectors

Item No.	Pack. Unit
2273-500	50 (10)

Accessories; item-specific
 Marking strips; on reel; 5 mm wide; plain; self-adhesive; white

white	210-834	1
-------	---------	---

Accessories; 2273 Series

Syringe; contains 20 ml "Alu-Plus" Contact Paste	249-130	20 (5)
--	---------	--------



PUSH WIRE® Connectors for Junction Boxes

773 Series

Description and Installation

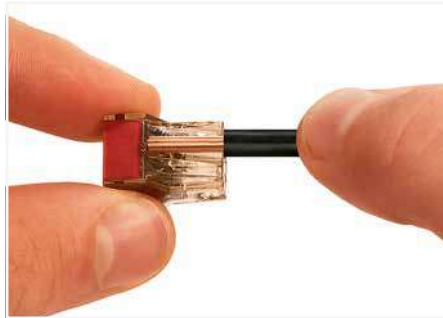
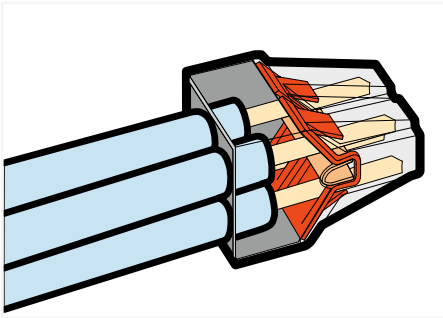

Strip a solid conductor to 12 mm (0.47 inch).



Termination: Insert stripped solid conductor until it hits backstop.



Removal: Hold conductor to be removed and twist alternately left and right while pulling the connector.

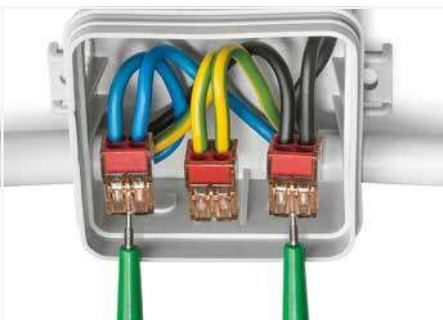

Testing



PUSH WIRE®
terminates the following
copper conductors:
solid "s"

Mounting Carrier; for PUSH WIRE® Junction Box Connectors; for DIN-35 Rail or Screw Mount 773 Series

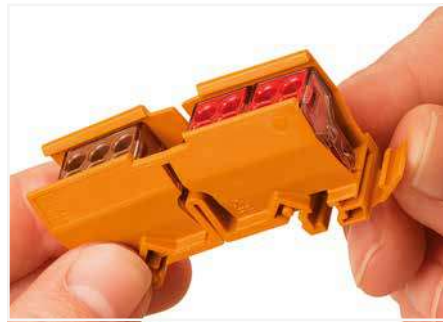
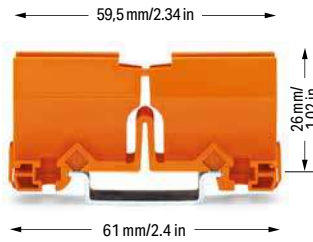

Use the cover as an end plate.

Mounting carrier; for all 773 Series PUSH WIRE® Connectors for Junction Boxes

Color	Item No.	Pack. Unit
orange	773-332	50 (10)

Accessories; item-specific

Marking strips; on reel; 5 mm wide; plain; self-adhesive; white

white	210-834	1
-------	---------	---

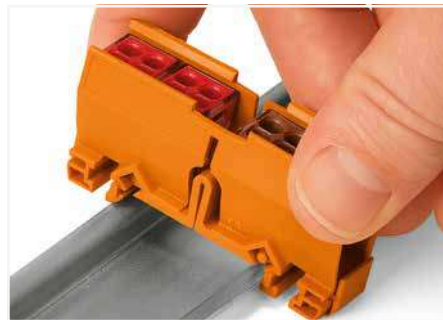

Snap the mounting carrier onto the DIN-rail.

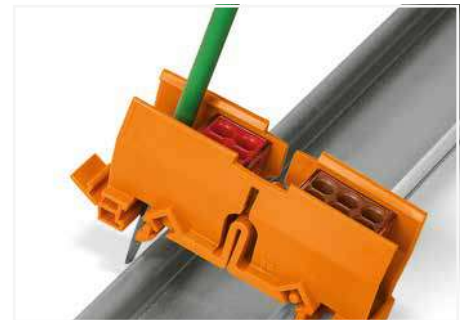

Remove the mounting carrier from the DIN-rail.



A mounting carrier (see accessories) suits applications where the connectors must be marked and secured in position. The DIN-35 rail-mount carrier fits up to six connectors and can also be mounted on a flat surface using two screws.

Using this PUSH WIRE® connector, a large range of wiring applications can be achieved in distribution or junction boxes. To mention just a few: potential multiplication and changing from or to 6 mm² (10 AWG) conductor size.

PUSH WIRE® Junction Box Connector for Solid Conductors 4 mm²; 773 Series

Technical Data

1.5 ... 4 mm² "s"

400 V / 4 kV / 2 ①

I_N 32 A

12 mm / 0.47 inch



Dimensions in mm

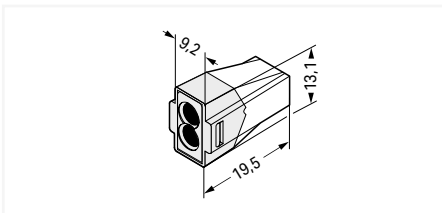

PUSH WIRE® junction box connector for solid conductors up to 4 mm²; 2-wire connector; transparent brown housing; white cover; continuous operating temperature (max.): 105 °C; surrounding air temperature (max.): 60 °C (T60)

Item No.	Pack. Unit
773-602	1000 (100)

Technical Data

1.5 ... 4 mm² "s"

400 V / 4 kV / 2 ①

I_N 32 A

12 mm / 0.47 inch



Dimensions in mm

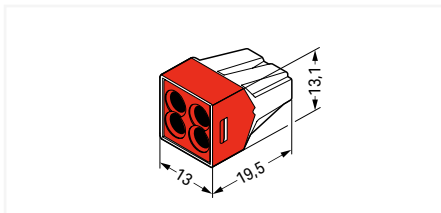

PUSH WIRE® junction box connector for solid conductors up to 4 mm²; 4-wire connector; transparent brown housing; red cover; continuous operating temperature (max.): 105 °C; surrounding air temperature (max.): 60 °C (T60)

Item No.	Pack. Unit
773-604	1000 (100)

Technical Data

1.5 ... 4 mm² "s"

400 V / 4 kV / 2 ①

I_N 32 A

12 mm / 0.47 inch



Dimensions in mm

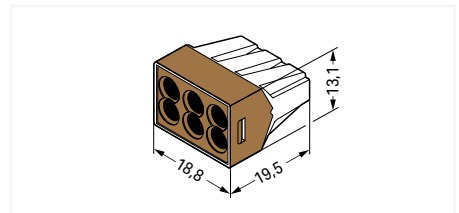

PUSH WIRE® junction box connector for solid conductors up to 4 mm²; 6-wire connector; transparent brown housing; brown cover; continuous operating temperature (max.): 105 °C; surrounding air temperature (max.): 60 °C (T60)

Item No.	Pack. Unit
773-606	500 (50)

Accessories; 773 Series

Syringe; contains 20 ml "Alu-Plus" Contact Paste



249-130 20 (5)

Mounting carrier; for single- and double-row connectors



orange 773-332 50 (10)

PUSH WIRE® Connector for Junction Boxes

2.5 mm² and 6 mm²; 773 Series

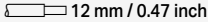
Technical Data	
0.75 ... 2.5 mm ² "s"	18 ... 12 AWG "s"
1.5 ... 2.5 mm ² "st"	16 ... 12 AWG "st"
400 V / 4 kV / 2 ①	600 V, 20 AⓄ
I _N 24 A	600 V, 20 AⓄ
 12 mm / 0.47 inch	

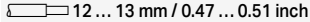
Technical Data	
2.5 ... 6 mm ² "s+st"	14 ... 10 AWG "s+st"
400 V / 4 kV / 2 ①	600 V, 30 AⓄ
I _N 41 A	600 V, 30 AⓄ
 12 ... 13 mm / 0.47 ... 0.51 inch	

- ① In grounded power lines
 400 V = rated voltage
 4 kV = rated impulse voltage
 2 = pollution degree
 (see Section 15)

Approvals and corresponding ratings,
 visit www.wago.com



Dimensions in mm

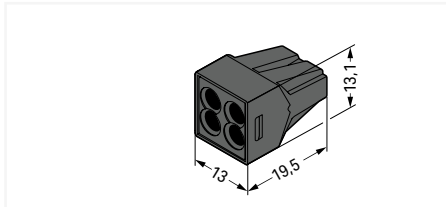

PUSH WIRE® connector for junction boxes; 4-wire connector; continuous operating temperature: 105 °C; surrounding air temperature (max.): 60 °C

Color	Item No.	Pack. Unit
● black	773-514	1000 (100)

Dimensions in mm

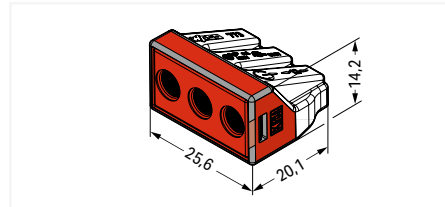

PUSH WIRE® connector for junction boxes; 3-wire connector; transparent housing; red cover; continuous operating temperature (max.): 105 °C; surrounding air temperature (max.): 60 °C

Color	Item No.	Pack. Unit
● red	773-173	500 (50)

Accessories; 773 Series

Syringe; contains 20 ml "Alu-Plus" Contact Paste

249-130 20 (5)



PUSH WIRE® Connectors in Distribution Boxes

During distribution box retrofits or expansions, conductors often require extensions or additional clamping points. Individual PUSH WIRE® connectors (e.g., 773 Series) are approved as interconnect components for building wiring applications per EN 60998. Application standards for building installation (e.g., Parts 510 and 520 from DIN VDE 0100) also place the following requirements on junction box connectors:

- They must be arranged so that operation, inspection, maintenance and access to the removable connectors is simplified.
- It must be possible to test them.
- Conductors connected from outside must be clearly and permanently assigned to their associated circuits.

These requirements cannot be met with PUSH WIRE® connectors alone. In combination with mounting carriers, the PUSH WIRE® connectors clearly meet these requirements, making them comparable to rail-mount terminal blocks. Using PUSH WIRE® connectors with mounting carriers in distribution boxes is accepted by testing authorities.

Ex PUSH WIRE® Connector for Junction Boxes 2.5 mm² and 6 mm²; 773 Series

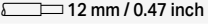
Technical Data	
0.75 ... 2.5 mm ² "s"	18 ... 14 AWG "s" 16 ... 12 AWG "st"
550 V ⓘ	
I _N 24 A	
	

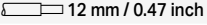
Technical Data	
0.75 ... 2.5 mm ² "s"	18 ... 14 AWG "s" 16 ... 12 AWG "st"
550 V ⓘ	
I _N 24 A	
	

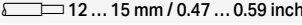
Technical Data	
2.5 ... 6 mm ² "s"	14 ... 10 AWG "s"
550 V ⓘ	
I _N 42 A	
	



Dimensions in mm

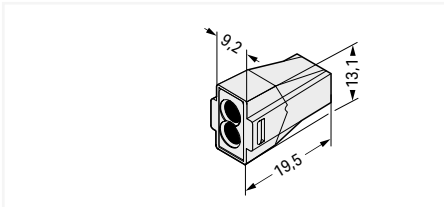

Dimensions in mm

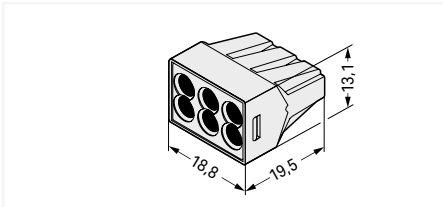

Dimensions in mm

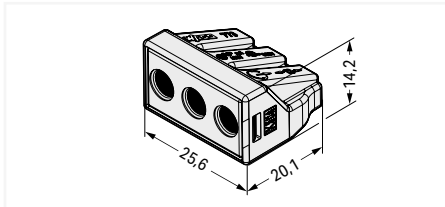

PUSH WIRE® connector for junction boxes; 2-wire connector		
Color	Item No.	Pack. Unit
○ light gray ⊕	773-492 Ⓜ	1000 (100)

PUSH WIRE® connector for junction boxes; 6-wire connector		
Color	Item No.	Pack. Unit
○ light gray ⊕	773-496 Ⓜ	500 (50)

PUSH WIRE® connector for junction boxes; 3-wire connector		
Color	Item No.	Pack. Unit
○ light gray ⊕	773-493 Ⓜ	500 (50)



Dimensions in mm

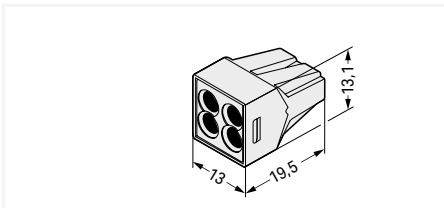

Dimensions in mm

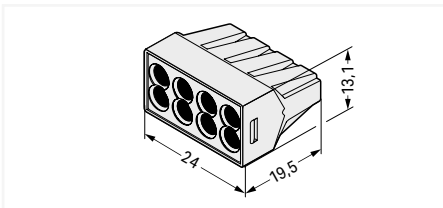

PUSH WIRE® connector for junction boxes; 4-wire connector		
Color	Item No.	Pack. Unit
○ light gray ⊕	773-494 Ⓜ	1000 (100)

PUSH WIRE® connector for junction boxes; 8-wire connector		
Color	Item No.	Pack. Unit
○ light gray ⊕	773-498 Ⓜ	500 (50)

13

Mounting Carrier; for Ex PUSH WIRE® Junction Box Connectors; for DIN-35 Rail or Screw Mount 773 Series

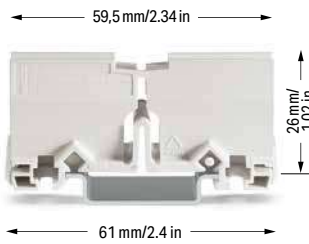

Mounting carrier; for Ex PUSH WIRE® junction box connectors

Color	Item No.	Pack. Unit
○ light gray ☺	773-331	50 (10)

Accessories; item-specific

Marking strips; on reel; 5 mm wide; plain; self-adhesive; white

	white	210-834	1
---	-------	---------	---

- 1 275 V at a distance < 10 mm to parts of other potentials
 - 2 To be used only in conjunction with a mounting carrier (773-331)
- Approvals and corresponding ratings, visit www.wago.com



Wiring example in an Ex junction box



Insert the connectors into the carrier.



Use the cover as an end plate.



Snap the mounting carrier onto the DIN-rail.



Remove the mounting carrier from the DIN-rail.

Ex PUSH WIRE® connectors are ideal for distribution and junction boxes, as well as control and operating systems. When used in hazardous areas, they offer the following advantages over traditional connectors:

- Time- and cost-saving PUSH WIRE® connection
- Vibration-proof, maintenance-free connections
- 100% touch-proof protection
- Connectors can be secured in position via mounting carriers
- One single carrier equipped with 2-, 4-, 6- and 8-wire connectors holds up to 16 clamping units according to user requirements, saving materials and related costs
- Available as OEM products for manufacturers and suppliers of enclosures and distribution boxes used in hazardous areas

MICRO PUSH WIRE® Junction Box Connectors for Solid Conductors

243 Series

Description and Installation

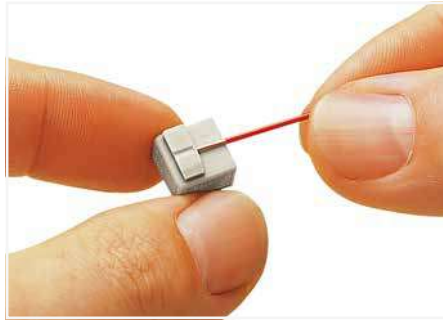
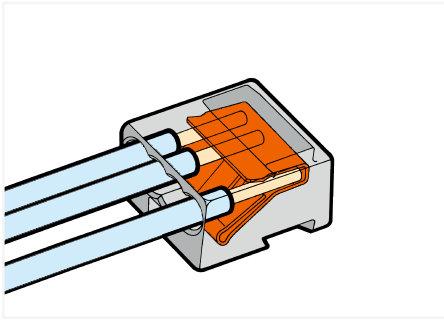

Strip solid conductors to 5 ... 6 mm (0.19 ... 0.23 inch).



Connector strips:
Assembling modular connectors into connector strips.

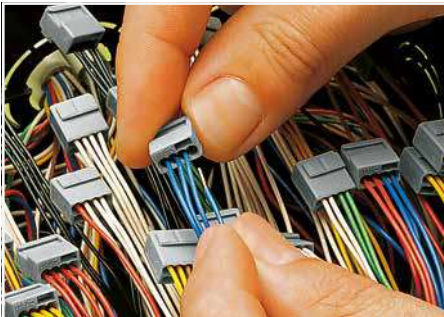

Termination: Insert stripped conductor until it hits back-stop.

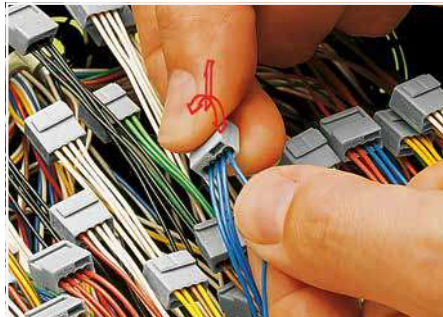

Removal: Hold conductor to be removed and twist alternately left and right while pulling the connector.



Testing



Commoned connector strips



PUSH WIRE®
terminates the following
copper conductors:
solid "s"

Mounting Carrier; for MICRO PUSH WIRE® Junction Box Connectors; for DIN-35 Rail or Screw Mount 243 Series

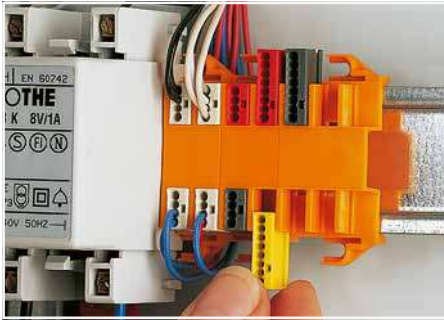

Inserting a MICRO junction box connector into the mounting carrier.

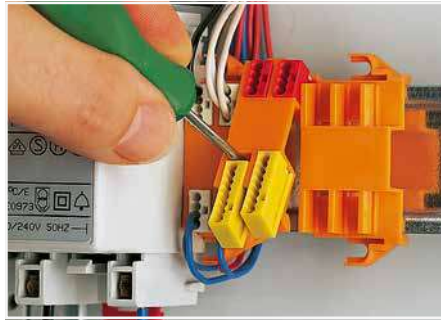

Removing a mounting carrier from the assembly.



Example of a residential door bell application – carriers mounted on a DIN-35 rail

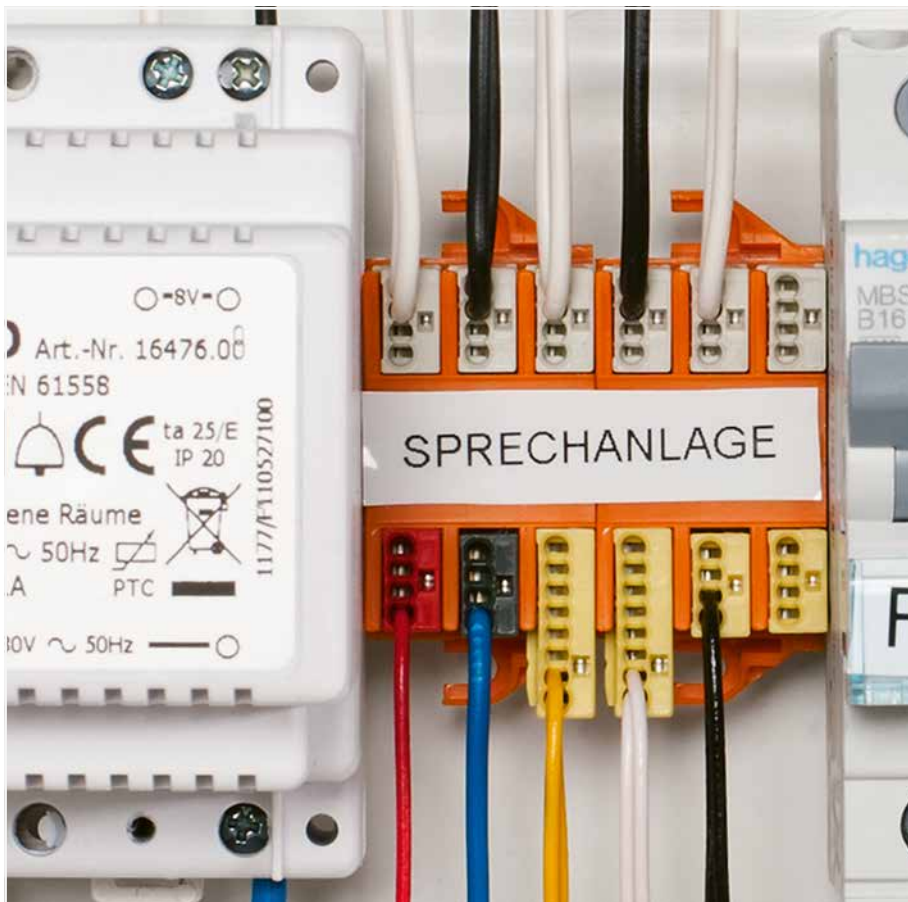

Example of a residential intercom application

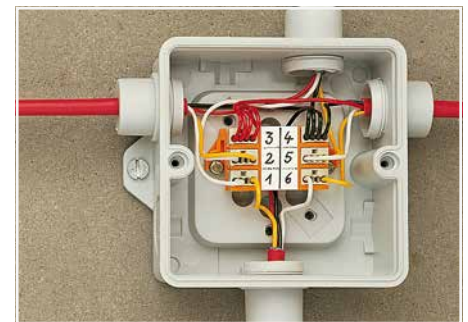

Typical application in a terminal box for burglar alarm – screw-mounted carrier

Quick Fix Mounting

Realizing MICRO PUSH WIRE® connectors for junction boxes are ideal for DIN-rail-mount panel applications, electrical installers have requested the ability to use them in distribution panels. These connectors provide easy connections for smaller conductors used in low-current applications. They are well-suited to terminating telephone-style conductors for connecting alarms, bells, door sensors, communication systems, etc.

The mounting carrier is WAGO's professional solution. It is available with mounting slots for 4 or 6 connectors.

Depending on the number of conductors, each mounting slot can accommodate a 4- or 8-conductor MICRO PUSH WIRE® junction box connector. The connectors simply snap into the mounting slots and are removable, allowing conductors to be exchanged during changeover.

The carrier is designed for easy mounting directly to the DIN-35 rail, or to a panel, via the screw-mount flanges provided on both sides. A large marking area for direct marking with a permanent felt-tip pen or for pre-printed self-adhesive marking strips is provided for clear circuit identification.

MICRO PUSH WIRE® Connector for Junction Boxes Ø 0.8 mm and Ø 0.5 mm; 243 Series

Technical Data

0.6 ... 0.8 mm Ø "s" ①	22 ... 20 AWG "s"
100 V / 1.5 kV / 2 ②	150 V, 7 A
I _N 6 A	150 V, 7 A
5 ... 6 mm / 0.2 ... 0.24 inch	

Technical Data

0.6 ... 0.8 mm Ø "s" ①	22 ... 20 AWG "s"
100 V / 1.5 kV / 2 ②	150 V, 7 A
I _N 6 A	150 V, 7 A
5 ... 6 mm / 0.2 ... 0.24 inch	

Technical Data

0.4 ... 0.5 mm Ø "s"	26 ... 24 AWG "s"
100 V / 1.5 kV / 2 ②	150 V, 7 A
I _N 6 A	150 V, 7 A
5 ... 6 mm / 0.2 ... 0.24 inch	



Dimensions in mm

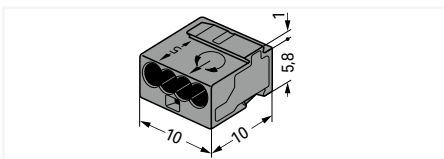

Dimensions in mm

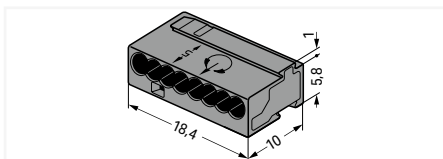

Dimensions in mm

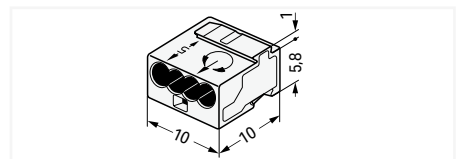

MICRO PUSH WIRE® connector for junction boxes; 4-wire connector; continuous operating temperature (max.): 105 °C; surrounding air temperature (max.): 60 °C

Color	Item No.	Pack. Unit
dark gray	243-204	1000 (100)
red	243-804	1000 (100)

MICRO PUSH WIRE® connector for junction boxes; 8-wire connector; continuous operating temperature (max.): 105 °C; surrounding air temperature (max.): 60 °C

Color	Item No.	Pack. Unit
dark gray	243-208	500 (50)
red	243-808	500 (50)

MICRO PUSH WIRE® connector for junction boxes; 4-wire connector; continuous operating temperature (max.): 105 °C; surrounding air temperature (max.): 60 °C

Color	Item No.	Pack. Unit
transparent	243-144	1000 (100)



Dimensions in mm

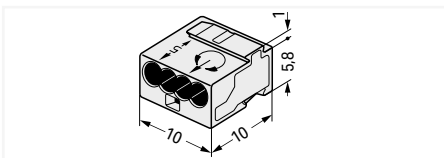

Dimensions in mm

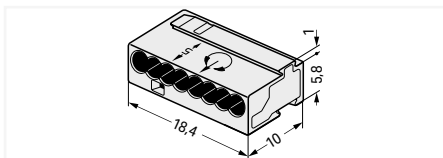

MICRO PUSH WIRE® connector for junction boxes; 4-wire connector; continuous operating temperature (max.): 105 °C; surrounding air temperature (max.): 60 °C

Color	Item No.	Pack. Unit
light gray	243-304	1000 (100)
yellow	243-504	1000 (100)

MICRO PUSH WIRE® connector for junction boxes; 8-wire connector; continuous operating temperature (max.): 105 °C; surrounding air temperature (max.): 60 °C

Color	Item No.	Pack. Unit
light gray	243-308	500 (50)
yellow	243-508	500 (50)

13

Mounting Carrier; for MICRO PUSH WIRE® Junction Box Connectors; for DIN-35 Rail or Screw Mount 243 Series

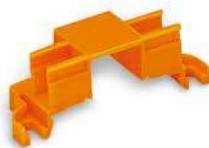

- ❶ When using conductors of the same diameter, 0.5 mm (24 AWG) or 1 mm (18 AWG) diameters are also possible.
 - ❷ 100 V = rated voltage
1.5 kV = rated impulse voltage
2 = pollution degree (see Section 15)
- Approvals and corresponding ratings, visit www.wago.com

Quick Fix Mounting

Realizing MICRO PUSH WIRE® connectors for junction boxes are ideal for DIN-rail-mount panel applications, electrical installers have requested the ability to use them in distribution panels. These connectors provide easy connections for smaller conductors used in low-current applications. They are well-suited to terminating telephone-style conductors for connecting alarms, bells, door sensors, communication systems, etc.

The mounting carrier is WAGO's professional solution. It is available with mounting slots for 4 or 6 connectors.

Depending on the number of conductors, each mounting slot can accommodate a 4- or 8-conductor MICRO PUSH WIRE® junction box connector. The connectors simply snap into the mounting slots and are removable, allowing conductors to be exchanged during changeover.

The carrier is designed for easy mounting directly to the DIN-35 rail, or to a panel, via the screw-mount flanges provided on both sides. A large marking area for direct marking with a permanent felt-tip pen or for pre-printed self-adhesive marking strips is provided for clear circuit identification.



Mounting carrier; for 4 connectors

Color	Item No.	Pack. Unit
orange	243-112	50 (10)

Accessories

Marking strips; on reel; 6 mm wide; plain; self-adhesive; white

	white	210-833	1
---	-------	---------	---



Mounting carrier; for 6 connectors

Color	Item No.	Pack. Unit
orange	243-113	50 (10)

Accessories

Marking strips; on reel; 6 mm wide; plain; self-adhesive; white

	white	210-833	1
---	-------	---------	---

COMPACT Splicing Connectors for All Conductor Types

221 Series

Description and Installation

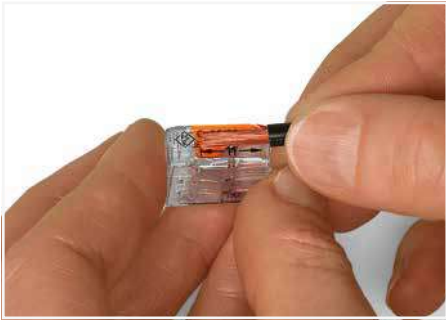

Strip conductor to 11 mm (0.43 inch).

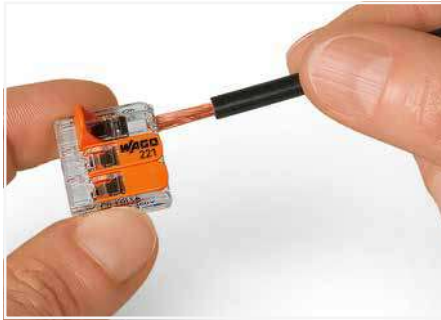

Termination: Lift the lever to open the clamping unit and insert a stripped conductor.

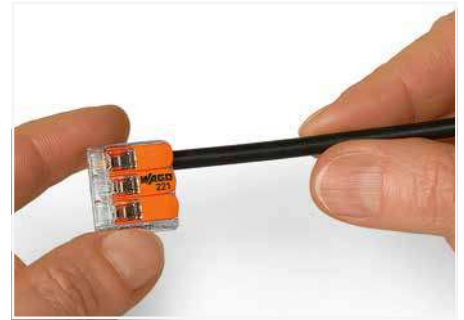

Then, lower the lever to close the clamp.

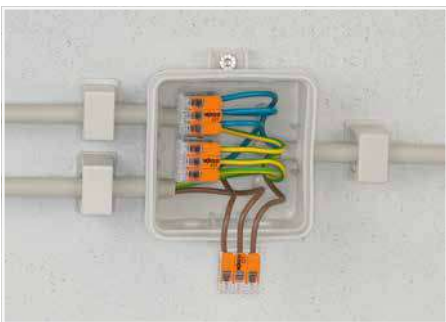

Wiring fine-stranded conductors in a junction box.



Custom low-voltage lighting system



13



Wiring fine-stranded conductors in a junction box for in-floor heating.



Lighting distribution in ceiling canopy



Pendant light connection in suspended ceilings

CAGE CLAMP® terminates the following copper conductors:
solid "s" stranded "st"

fine-stranded "f-st", also with tinned single strands

fine-stranded, tip-bonded

COMPACT Splicing Connector for All Conductor Types 4 mm²; 221 Series

Technical Data

0.2 ... 4 mm ² "s+str"	24 ... 12 AWG
0.14 ... 4 mm ² "f-st"	600 V, 20 A [Ⓢ]
450 V / 4 kV / 2 ①	600 V, 20 A [Ⓢ]
I _N 32 A	
 11 mm / 0.43 inch	

Technical Data

0.2 ... 4 mm ² "s+str"	24 ... 12 AWG
0.14 ... 4 mm ² "f-st"	600 V, 20 A [Ⓢ]
450 V / 4 kV / 2 ①	600 V, 20 A [Ⓢ]
I _N 32 A	
 11 mm / 0.43 inch	

- ① 450 V = rated voltage
4 kV = rated impulse voltage
2 = pollution degree
(see Section 15)

Approvals and corresponding ratings, visit www.wago.com



Dimensions in mm

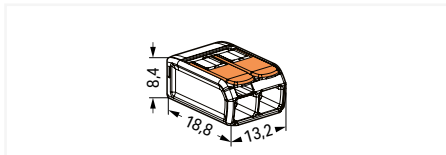

COMPACT splicing connector; for all conductor types; 2-conductor; with levers; transparent housing; continuous operating temperature (max.): 105 °C; surrounding air temperature: max 85 °C (T85)

Item No.	Pack. Unit
221-412	1000 (100)

Dimensions in mm

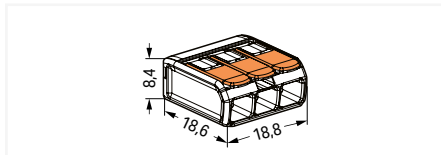

COMPACT splicing connector; for all conductor types; 3-conductor; with levers; transparent housing; continuous operating temperature (max.): 105 °C; surrounding air temperature: max 85 °C (T85)

Item No.	Pack. Unit
221-413	500 (50)



Compact, lever-operated splicing connectors:
Tool-free connection of up to five stripped, fine-stranded conductors from 0.14 ... 4 mm², as well as solid or stranded conductors from 0.2 ... 4 mm² (24 ... 12 AWG).

How these work:

Pull up an orange lever to open the clamping unit. Then insert the conductor and push the lever back down, flush with the connector housing.

Safety:

The specially designed rest position of the lever reliably prevents accidental unclamping of a connected conductor.

Application safety, for any type of conductor (solid, stranded, fine-stranded), is confirmed by approvals like ENEC or UL.

ENEC is the European mark for electrical products that demonstrates compliance with European safety standards. The ENEC mark is subjected to the same EN standards as the VDE mark.

While the VDE mark is only permitted in Germany, the ENEC mark is accepted in more than 20 European countries.



Dimensions in mm

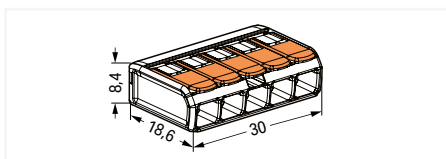

COMPACT splicing connector; for all conductor types; 5-conductor; with levers; transparent housing; continuous operating temperature (max.): 105 °C; surrounding air temperature: max 85 °C (T85)

Item No.	Pack. Unit
221-415	250 (25)

Mounting Carrier 221 Series Installation



Inserting a connector into the mounting carrier.

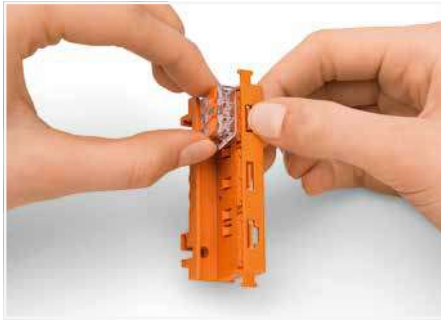

Removing a connector from the mounting carrier.



Removing a conductor.



Testing connectors via test slots on top of the carrier.

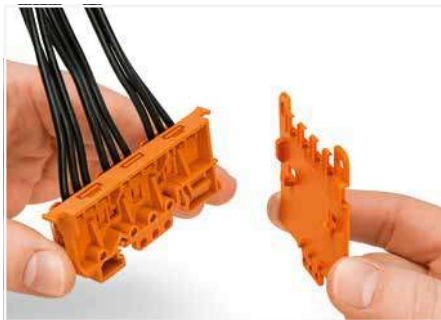

Securing a strain relief plate (222-505) to the mounting carrier.

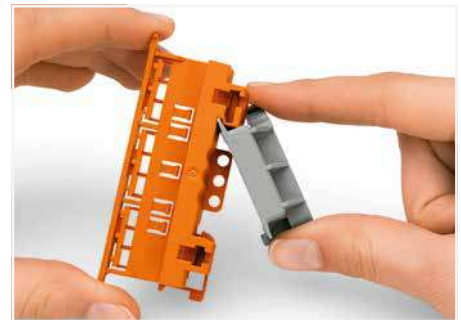

Snapping the angled DIN-rail adapter (222-510) onto the mounting carrier.



Strain relief via cable ties on the mounting carrier (transverse to the connectors' wiring direction) – clamping units labeled via marking strips (210-334)



Vertical mounting with strain relief plate on DIN-35 rail



Horizontal mounting on DIN-35 rail using an angled DIN-rail adapter

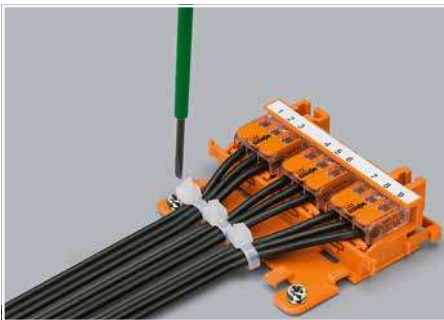

Horizontal screw mounting with strain relief plate on a flat surface



Vertical screw mounting with strain relief plate on a flat surface

13

Mounting Carrier 221 Series

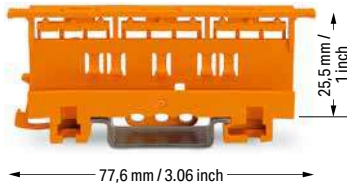

Mounting carrier; for 2-, 3- and 5-wire splicing connectors (4 mm²); 17.5 mm wide

Color	Item No.	Pack. Unit
orange	221-500	50 (10)
blue	221-500/000-006 ①	50 (10)
dark gray/yellow	221-500/000-053	50 (10)

Accessories; item-specific

Marking strips; on reel; 6 mm wide; plain; self-adhesive; white

	white	210-833	1
---	-------	---------	---

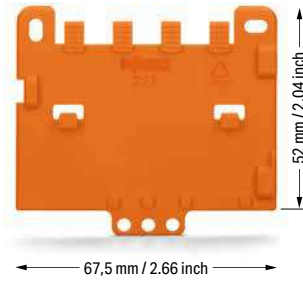

Strain relief plate; for mounting carrier (221 or 222 Series); snaps on to mounting carrier; 4 mm thick

Color	Item No.	Pack. Unit
orange	222-505	50 (10)

① Carriers with a blue insulated housing are suitable for Ex i applications. Both clearances and creepage distances for the protection type "intrinsic safety Ex i" must be observed.

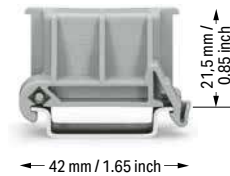

Angled DIN-rail adapter; in combination with mounting carrier (221-500 or 222-500) for DIN-35 rail mounting; 18.5 mm wide

Color	Item No.	Pack. Unit
gray	222-510	50 (10)

Mounting Carrier; for Single Connectors 221 Series Installation



Inserting a connector into the mounting carrier.



Removing a connector from the mounting carrier.



Inserting a conductor.



Use a cable tie to secure the conductors to the strain relief plate.



Labeling the mounting carrier.

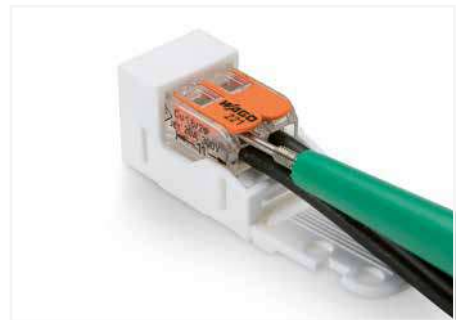

Testing a connector mounted on the carrier via test slot.



The strain relief plate can be removed.



Horizontal screw mounting



Vertical screw mounting



Horizontal mounting via snap-in foot



Vertical mounting via snap-in foot



Connecting a light to the mains.

13

Mounting Carrier; for Single Connectors 221 Series



Dimensions in mm

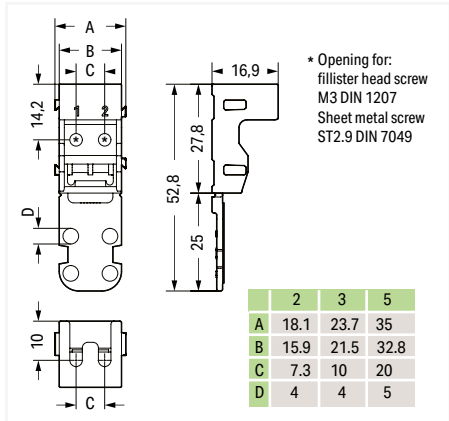

Mounting carrier; for 2-wire connectors (4 mm²); for screw mounting
Dimensions from the surface (mm) W x H x D
18.1 x 16.9 x 52.8

Color	Item No.	Pack. Unit
○ white	221-502	50 (10)
● black	221-502/000-004	50 (10)

Mounting carrier; for 2-wire connectors (4 mm²); with snap-in mounting foot for horizontal mounting
Dimensions from the surface (mm) W x H x D
18.1 x 16.9 (+ 4.5 snap-in mounting foot) x 52.8

○ white	221-512	50 (10)
● black	221-512/000-004	50 (10)

Mounting carrier; for 2-wire connectors (4 mm²); with snap-in mounting foot for vertical mounting
Dimensions from the surface (mm) W x H x D
18.1 x 52.8 (+ 4.5 snap-in mounting foot) x 16.9

○ white	221-522	50 (10)
● black	221-522/000-004	50 (10)

More information on dimensions is available upon request.

Accessories; item-specific

Marking strips; on reel; 6 mm wide; plain; self-adhesive; white

 white	210-833	1
---	---------	---

Dimensions in mm

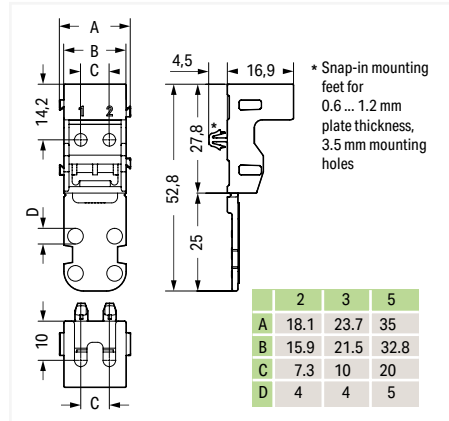

Mounting carrier; for 3-wire connectors (4 mm²); for screw mounting
Dimensions from the surface (mm) W x H x D
18.1 x 16.9 x 52.8

Color	Item No.	Pack. Unit
○ white	221-503	50 (10)
● black	221-503/000-004	50 (10)

Mounting carrier; for 3-wire connectors (4 mm²); with snap-in mounting foot for horizontal mounting
Dimensions from the surface (mm) W x H x D
18.1 x 16.9 (+ 4.5 snap-in mounting foot) x 52.8

○ white	221-513	50 (10)
● black	221-513/000-004	50 (10)

Mounting carrier; for 3-wire connectors (4 mm²); with snap-in mounting foot for vertical mounting
Dimensions from the surface (mm) W x H x D
18.1 x 52.8 (+ 4.5 snap-in mounting foot) x 16.9

○ white	221-523	50 (10)
● black	221-523/000-004	50 (10)

Dimensions in mm

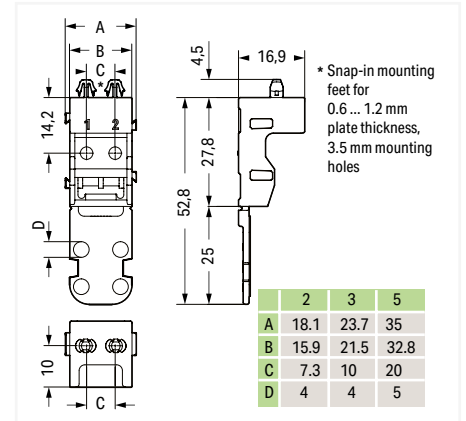

Mounting carrier; for 5-wire connectors (4 mm²); for screw mounting
Dimensions from the surface (mm) W x H x D
18.1 x 16.9 x 52.8

Color	Item No.	Pack. Unit
○ white	221-505	50 (10)
● black	221-505/000-004	50 (10)

Mounting carrier; for 5-wire connectors (4 mm²); with snap-in mounting foot for horizontal mounting
Dimensions from the surface (mm) W x H x D
18.1 x 16.9 (+ 4.5 snap-in mounting foot) x 52.8

○ white	221-515	50 (10)
● black	221-515/000-004	50 (10)

Mounting carrier; for 5-wire connectors (4 mm²); with snap-in mounting foot for vertical mounting
Dimensions from the surface (mm) W x H x D
18.1 x 52.8 (+ 4.5 snap-in mounting foot) x 16.9

○ white	221-525	50 (10)
● black	221-525/000-004	50 (10)

COMPACT Splicing Connectors for All Conductor Types

221 Series

Description and Installation

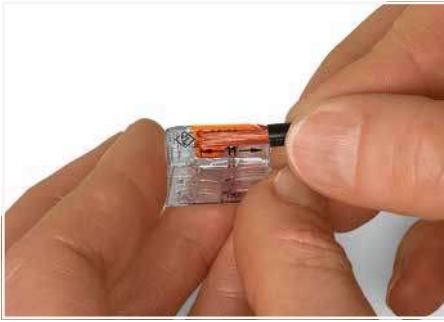

Strip conductor to 12 ... 14 mm (0.47 ... 0.55 inch).

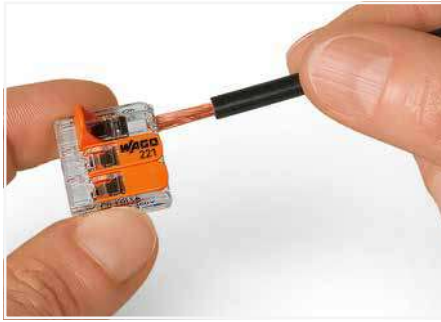

Termination: Lift the lever to open the clamping unit and insert a stripped conductor.

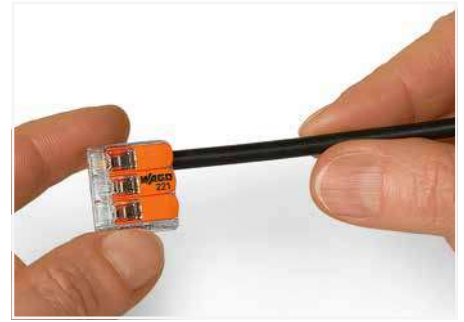

Then, lower the lever to close the clamp.

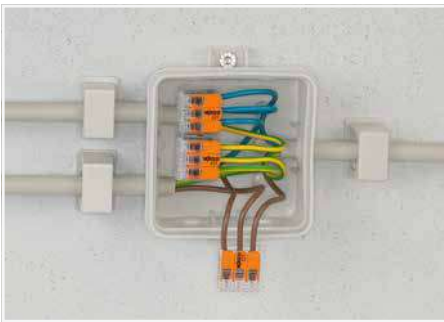

Wiring fine-stranded conductors in a junction box.



Custom low-voltage lighting system



Wiring fine-stranded conductors in a junction box for in-floor heating.



Lighting distribution in ceiling canopy



Pendant light connection in suspended ceilings

13

CAGE CLAMP® terminates the following copper conductors:
solid "s" stranded "st"

fine-stranded "f-st", also with tinned single strands

fine-stranded, tip-bonded

COMPACT Splicing Connector for All Conductor Types and Mounting Carrier

6 mm²; 221 Series

Technical Data	
0.5 ... 6 mm ²	20 ... 10 AWG
450 V / 4 kV / 2 ①	600 V, 30 A [Ⓢ]
I _N 41 A	600 V, 20 A [Ⓢ]
 12 ... 14 mm / 0.47 ... 0.55 inch	

Technical Data	
0.5 ... 6 mm ²	20 ... 10 AWG
450 V / 4 kV / 2 ①	600 V, 30 A [Ⓢ]
I _N 41 A	600 V, 20 A [Ⓢ]
 12 ... 14 mm / 0.47 ... 0.55 inch	

- ① 450 V = rated voltage
4 kV = rated impulse voltage
2 = pollution degree
(see Section 15)
 - ② Carriers with a blue insulated housing are suitable for Ex i applications. Both clearances and creepage distances for the protection type "intrinsic safety Ex i" must be observed.
- Approvals and corresponding ratings, visit www.wago.com



Dimensions in mm

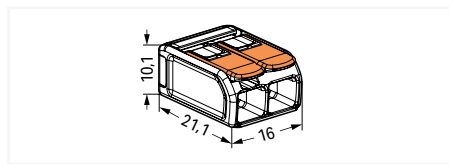

Dimensions in mm

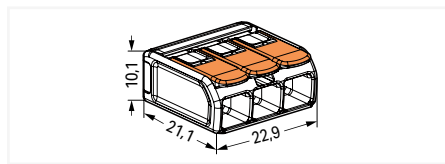

COMPACT splicing connector; for all conductor types; 2-conductor; with levers; transparent housing; continuous operating temperature (max.): 105 °C; surrounding air temperature: max 85 °C (T85)

Item No.	Pack. Unit
221-612	500 (50)

COMPACT splicing connector; for all conductor types; 3-conductor; with levers; transparent housing; continuous operating temperature (max.): 105 °C; surrounding air temperature: max 85 °C (T85)

Item No.	Pack. Unit
221-613	300 (30)



Compact, lever-operated splicing connectors:
Connect up to five stripped conductors from 0.5 to 6 mm² (20 ... 10 AWG) – without tools!

How these work:
Pull up one of the orange operating levers to open the clamping unit. Then insert the conductor and push the lever back down, flush with the connector housing.

Safety:
The lever's specially designed rest position reliably prevents accidental unclamping of a connected conductor. Application safety, for any type of conductor (solid, stranded, fine-stranded), is confirmed by approvals like ENEC or UL.

ENEC is the European mark for electrical products that demonstrates compliance with European safety standards. The ENEC mark is subjected to the same EN standards as the VDE mark.

While the VDE mark is only permitted in Germany, the ENEC mark is accepted in more than 20 European countries.

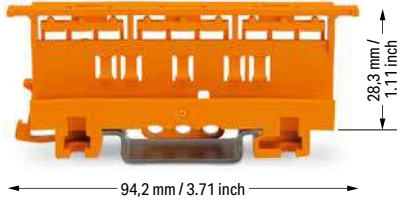
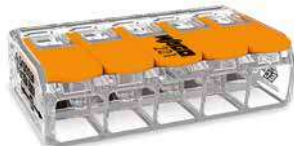

Dimensions in mm

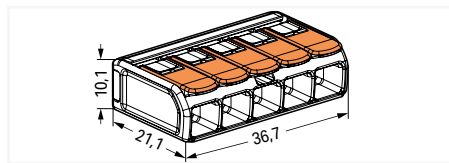

COMPACT splicing connector; for all conductor types; 5-conductor; with levers; transparent housing; continuous operating temperature (max.): 105 °C; surrounding air temperature: max 85 °C (T85)

Item No.	Pack. Unit
221-615	150 (15)

Mounting carrier; for 2-, 3- and 5-wire splicing connectors (6 mm²); 19.3 mm wide

Color	Item No.	Pack. Unit
orange	221-510	50 (10)
blue	221-510/000-006 ②	50 (10)
dark gray/yellow	221-510/000-053	50 (10)

Accessories; item-specific
Marking strips; on reel; 6 mm wide; plain; self-adhesive; white

	white	210-833	1
---	-------	---------	---

COMPACT Splicing Connectors for All Conductor Types and Mounting Carrier for Ex Splicing Connectors; for Ex eb Applications; 221 Series Description and Installation

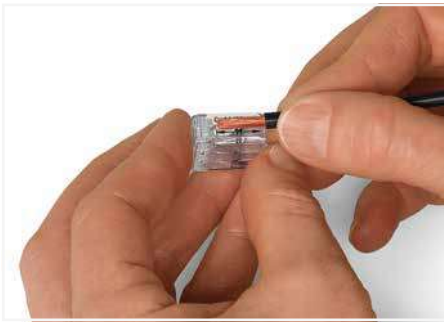

Strip conductor to 11 mm (0.43 inch).

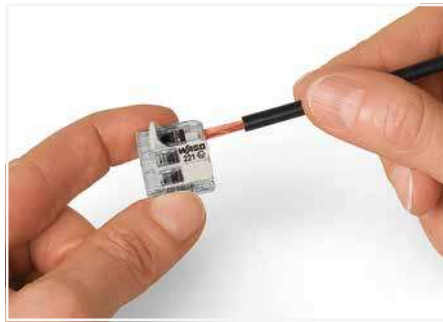

Termination: Lift the lever to open the clamping unit and insert a stripped conductor.

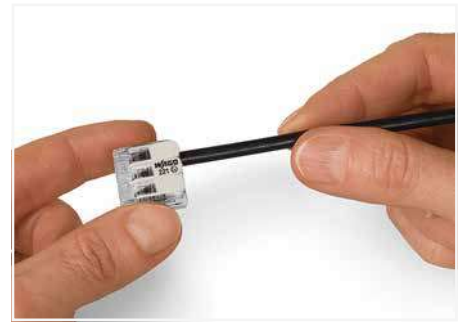

Then, lower the lever to close the clamp.

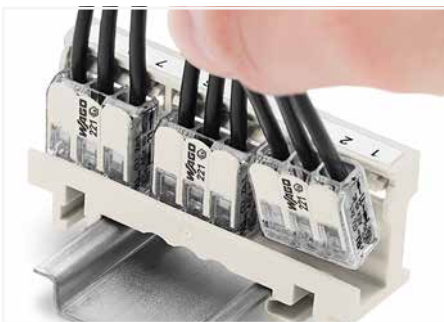

Inserting a connector into the mounting carrier.

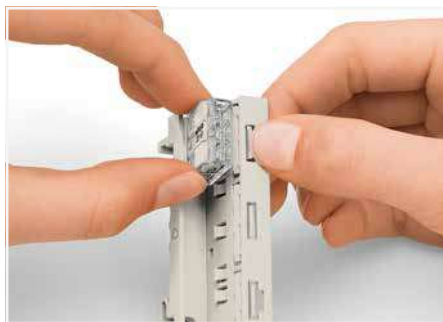

Removing a connector from the mounting carrier.



Removing a conductor.

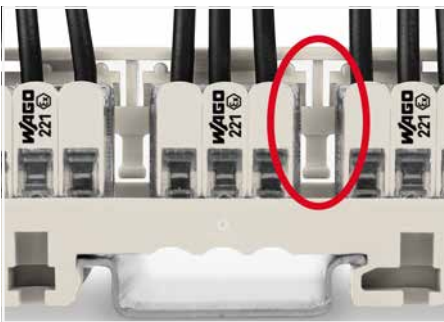

Mounting type (440 V)
A spacer integrated in the adapter can be seen between two connectors.



Mounting type (440 V)
Vertical mounting on DIN-35 rail



Mounting type (275 V)
A spacer integrated in the adapter **cannot** be seen between two connectors; the connector housings are close together.



Mounting type (440 V)
Horizontal screw mounting on a flat surface



Mounting type (440 V)
Mounting the carrier via non-conductive screws.



Mounting type (275 V)
Mounting the carrier using conductive screws.

CAGE CLAMP® terminates the following copper conductors:
solid "s" stranded "st"

fine-stranded "f-st",
also with tinned
single strands

fine-stranded,
tip-bonded

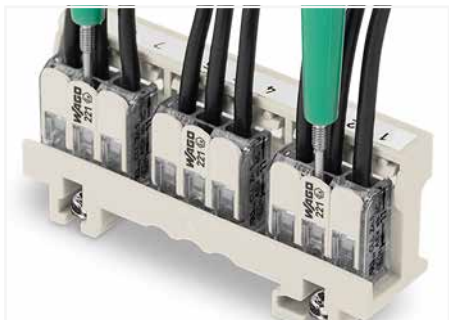

Easily test inserted connectors in the carrier – however they are mounted.



Wiring example in an Ex e junction box
Labeling is performed via marking strips (210-334) and pen or continuous labels (210-834), which is printed via Smart Printer (258-5000).



Carriers with a blue insulated housing are suitable for Ex i applications. Both clearances and creepage distances for the protection type "intrinsic safety Ex i" must be observed.

COMPACT Splicing Connector for All Conductor Types and Mounting Carrier; for Ex eb Applications

4 mm²; 221 Series

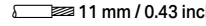
Technical Data	
IEC / EN 60079-7	UL 60079-7
Ⓜ IECEX Ex eb IIC Gb	Ⓜ Cl. I, Zn. 1, AEx eb IIC CNR Ex eb IIC U
0.2 ... 4 mm² "s+str"	24 ... 12 AWG "s+st"
0.14 ... 4 mm² "f-st"	24 ... 12 AWG "f-st"
440 V (275 V) ①	440 V (275 V), 20 A, $I_{N 32 A}$ ①
I_N 24.5 A	
Operating temperature: -55 ... +105 °C	
	

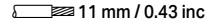
Technical Data	
IEC / EN 60079-7	UL 60079-7
Ⓜ IECEX Ex eb IIC Gb	Ⓜ Cl. I, Zn. 1, AEx eb IIC CNR Ex eb IIC U
0.2 ... 4 mm² "s+str"	24 ... 12 AWG "s+st"
0.14 ... 4 mm² "f-st"	24 ... 12 AWG "f-st"
440 V (275 V) ①	440 V (275 V), 20 A, $I_{N 32 A}$ ①
I_N 32 A	
Operating temperature: -55 ... +105 °C	
	

- ① The permissible operating voltage of the connector with carrier (440 V or 275 V) depends on the mounting type.
The mounting types for both 440 V and 275 V are shown on the "Description and Installation" page. If a mounting type for 275 V is used, this is the permissible working voltage.
- ② Only approved in conjunction with a mounting carrier (221-501). Other carriers are possible, see certificate (UL).
The connectors must be installed in an enclosure meeting the requirements of a recognized protection type per EN 60079-0, Section 1 or EN 60079-31. When installing the connectors in an enclosure of protection type "eb" (increased safety) per EN 60079-7, the clearances and creepage distances of Table 2 for this standard must be observed (for the use of accessories see point 1).
The connectors can be used both in Group II and Group I, as the standard requirements are identical in this case.
The use of these components requires a new assessment by a notified certification agency.
- ③ Carriers with a blue insulated housing are suitable for Ex i applications. Both clearances and creepage distances for the protection type "intrinsic safety Ex i" must be observed.

Approvals and corresponding ratings, visit www.wago.com



Dimensions in mm

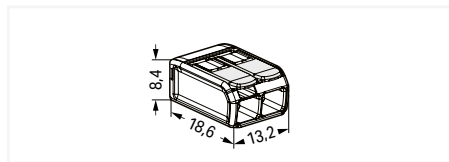

Dimensions in mm

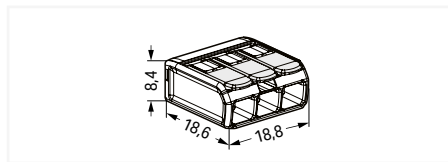

COMPACT splicing connector; for all conductor types; for Ex eb applications; 2-conductor; with levers; transparent housing; operating temperature (max.): 105 °C

Item No.	Pack. Unit
221-482 ②	1000 (100)

COMPACT splicing connector; for all conductor types; for Ex eb applications; 3-conductor; with levers; transparent housing; operating temperature (max.): 105 °C

Item No.	Pack. Unit
221-483 ②	500 (50)

Your benefits at a glance:

- New design possibilities for the manufacturers of junction boxes, luminaires and electronic devices for Ex eb areas
- Approval also possible with custom mounting solutions
- Easy to use: Pull the lever up, insert a conductor and push the lever back down – done.
- Easy-to-use design adds value for installers
- Time- and cost-saving spring pressure connection technology
- Vibration-proof and maintenance-free connection
- 100% touch-proof protection
- Connectors can be secured in position via mounting carriers according to standards

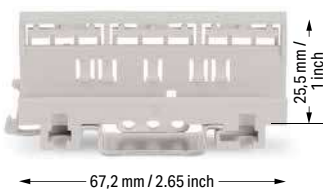

Dimensions in mm

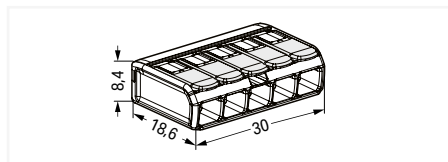

Mounting carrier; for 2-, 3- and 5-wire Ex splicing connectors (4 mm²); 17.5 mm wide

Color	Item No.	Pack. Unit
○ light gray	221-501	50 (10)
● blue	221-500/000-006 ③	50 (10)

Item-Specific Accessories

Marking strips; on reel; 6 mm wide; plain; self-adhesive; white

	white	210-833	1
--	-------	---------	---

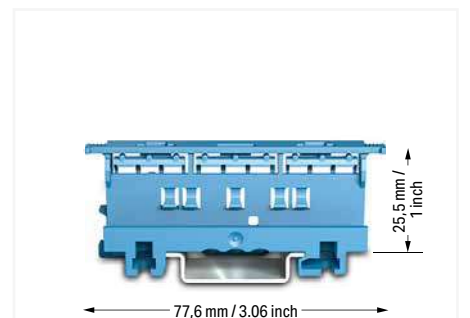

Carriers with a blue insulated housing are suitable for Ex i applications. Both clearances and creepage distances for the protection type "intrinsic safety Ex i" must be observed.

COMPACT Splicing Connector for All Conductor Types and Mounting Carrier; for Ex eb Applications

6 mm²; 221 Series

Technical Data	
IEC / EN 60079-7	UL 60079-7
Ⓔ IECEX Ex eb IIC Gb	Ⓔ Cl. I, Zn. 1, AEx eb IIC CNR Ex eb IIC U
0.5 ... 6 mm ²	20 ... 10 AWG
440 V (275 V) ①	440 V (275 V), 20 A Ⓔ ^{UL} ①
I _N 37 A	
Operating temperature: -55 ... +105 °C	
12 ... 14 mm / 0.47 ... 0.55 inch	

Technical Data	
IEC / EN 60079-7	UL 60079-7
Ⓔ IECEX Ex eb IIC Gb	Ⓔ Cl. I, Zn. 1, AEx eb IIC CNR Ex eb IIC U
0.5 ... 6 mm ²	20 ... 10 AWG
440 V (275 V) ①	440 V (275 V), 20 A Ⓔ ^{UL} ①
I _N 37 A	
Operating temperature: -55 ... +105 °C	
12 ... 14 mm / 0.47 ... 0.55 inch	



Dimensions in mm

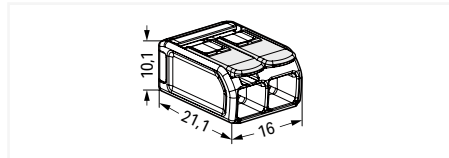

Dimensions in mm

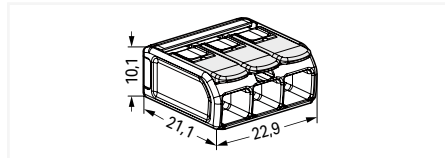

COMPACT splicing connector; for all conductor types; for Ex eb applications; 2-conductor; with levers; transparent housing; operating temperature (max.): 105 °C

Item No.	Pack. Unit
221-682 ②	500 (50)

COMPACT splicing connector; for all conductor types; for Ex eb applications; 3-conductor; with levers; transparent housing; operating temperature (max.): 105 °C

Item No.	Pack. Unit
221-683 ②	300 (30)

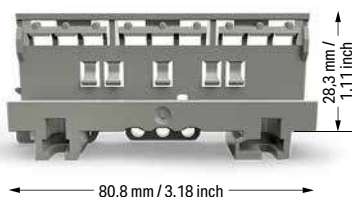

Dimensions in mm

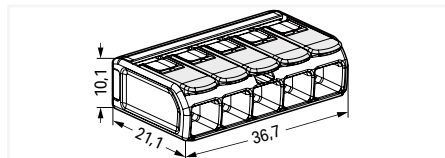

Mounting carrier; for 2-, 3- and 5-wire Ex splicing connectors (6 mm²); 19.3 mm wide

Color	Item No.	Pack. Unit
○ light gray	221-511	50 (10)
● blue	221-510/000-006 ③	50 (10)

Item-Specific Accessories

Marking strips; on reel; 6 mm wide; plain; self-adhesive; white

white	210-833	1
-------	---------	---

① The permissible operating voltage of the connector with carrier (440 V or 275 V) depends on the mounting type.
The mounting types for both 440 V and 275 V are shown on the "Description and Installation" page. If a mounting type for 275 V is used, this is the permissible working voltage.

② Only approved in conjunction with a mounting carrier (221-511). Other carriers are possible, see certificate (UL).
The connectors must be installed in an enclosure meeting the requirements of a recognized protection type per EN 60079-0, Section 1 or EN 60079-31. When installing the connectors in an enclosure of protection type "eb" (increased safety) per EN 60079-7, the clearances and creepage distances of Table 2 for this standard must be observed (for the use of accessories see point 1).
The connectors can be used both in Group II and Group I, as the standard requirements are identical in this case.
The use of these components requires a new assessment by a notified certification agency.

③ Carriers with a blue insulated housing are suitable for Ex i applications. Both clearances and creepage distances for the protection type "intrinsic safety Ex i" must be observed.

Approvals and corresponding ratings, visit www.wago.com

Your benefits at a glance:

- New design possibilities for the manufacturers of junction boxes, luminaires and electronic devices for Ex eb areas
- Approval also possible with custom mounting solutions
- Easy to use: Pull the lever up, insert a conductor and push the lever back down – done.
- Easy-to-use design adds value for installers
- Time- and cost-saving spring pressure connection technology
- Vibration-proof and maintenance-free connection
- 100% touch-proof protection
- Connectors can be secured in position via mounting carriers according to standards



Carriers with a blue insulated housing are suitable for Ex i applications. Both clearances and creepage distances for the protection type "intrinsic safety Ex i" must be observed.

Jumpers With and Without Locking Function Installation

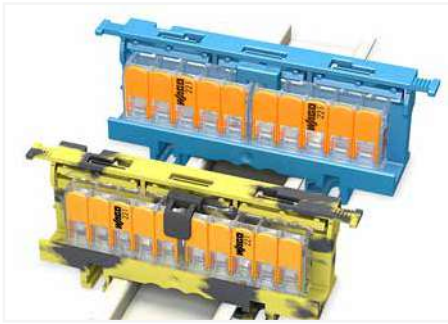

Extending the N and PE (ground) distribution via jumper

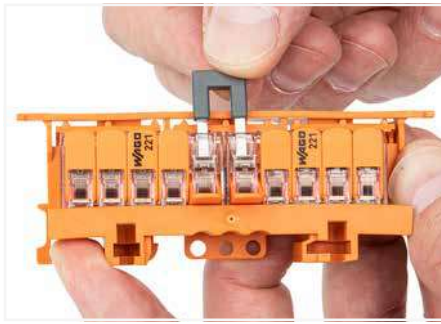

Insert the jumper without a locking function into open clamping units.

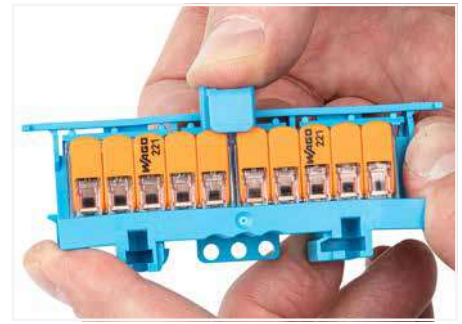

Insert the jumper with a locking function into closed clamping units.

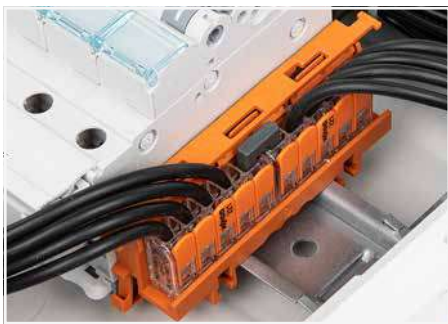

Without locking function:
The jumper without a locking function is plugged into the splicing connectors.

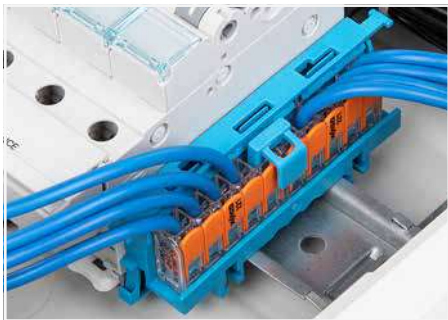

With locking function:
The jumper with a locking function is plugged into the splicing connectors.

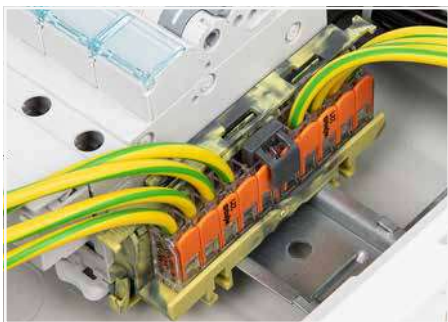

The lockable jumper is plugged into the splicing connectors.

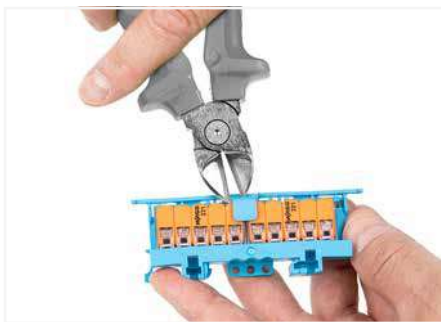

Remove the locking mechanism for intentional jumper removal.



Remove the jumper from open clamping units.

Jumper With and Without Locking Function 221 Series

Technical Data

400 V
I_N 41 A



Technical Data

400 V
I_N 41 A



Jumper; with locking function

	Item No.	Pack. Unit
● dark gray	221-941	50
● blue	221-941/000-006	50

Jumper; without locking function

	Item No.	Pack. Unit
● dark gray	221-942	50
● blue	221-942/000-006	50

Gelboxes; for Splicing Connectors 207 Series Installation



Open the Gelbox at the side latches.

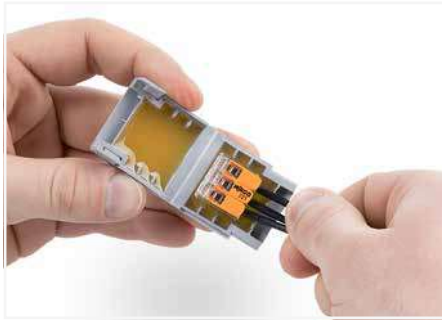

Place the wired connector in the Gelbox.

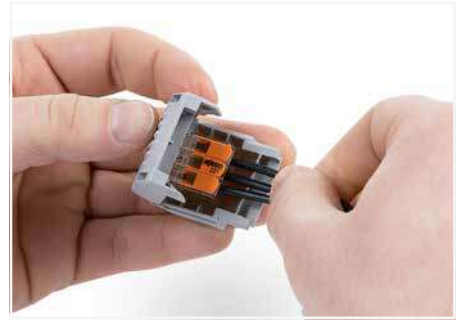

Close the Gelbox.



Close latch securely and press down in the center.



Re-accessible:
Open the Gelbox, remove the gel, open the connector and rewire with new components.



For low voltage applications > 50 V, use the Gelbox in a junction box.



Connecting a bollard light



Opened Gelbox with connector

13

Gelbox; for Splicing Connectors 207 Series

Technical Data

Housing material: Polypropylene
Gel material: Polyurethane
Voltage range: see connector voltage
Rated current: see connector current
Rated surge voltage: 2.5 kV
Insulation resistance: 5 MΩ
Surrounding air temperature (operation): -55 ... 85 °C
Surrounding air temperature (storage): 0 ... 40 °C
Physical properties: IPX8
Suitable for indefinite storage because the gel is free of hazardous substance according to CLP
Disposal: Household waste (residual waste)
Skin contact: After skin contact, clean with water; no special cleaning agent required



Gelbox; for conductors; branch; with gel; 221, 2273 Series; without splicing connectors; size 1		
Color	Item No.	Pack. Unit
○ gray	207-1331	48 (4)

Gelbox; for conductors; branch; with gel; 221, 2273 Series; without splicing connectors; size 2		
Color	Item No.	Pack. Unit
○ gray	207-1332	48 (4)

Gelbox; for conductors; branch; with gel; 221, 2273 Series; without splicing connectors; size 3		
Color	Item No.	Pack. Unit
○ gray	207-1333	36 (3)

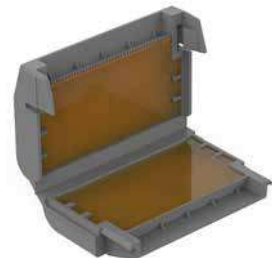
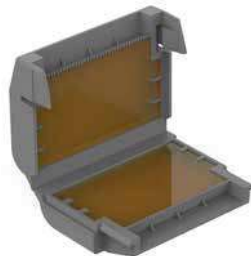

Gelbox; for conductors; branch; with gel; 221 Series, max. 6 mm² connectors; without splicing connectors; size 1		
Color	Item No.	Pack. Unit
○ gray	207-1431	48 (4)

Gelbox; for conductors; branch; with gel; 221 Series, max. 6 mm² connectors; without splicing connectors; size 2		
Color	Item No.	Pack. Unit
○ gray	207-1432	36 (3)

Gelbox; for conductors; branch; with gel; 221 Series, max. 6 mm² connectors; without splicing connectors; size 3		
Color	Item No.	Pack. Unit
○ gray	207-1433	24 (2)

Permitted Combinations of Connectors and Gelbox:

Item No.	221-412	221-413	221-415	221-612	221-613	221-615	2273-202	2273-203	2273-204	2273-208
207-1331	1 x	1 x	-				2 x	-	1 x	1 x
207-1332	2 x	-	1 x				3 x	2 x	-	1 x
207-1333	3 x	2 x	-				4 x	-	2 x	2 x
207-1431				1 x	1 x	-				
207-1432				2 x	-	1 x				
207-1433				3 x	2 x	-				

Note: With other combinations, the high degree of protection cannot be guaranteed because the gel displacement is too limited or the Gel Boxes can no longer be closed.

Gelboxes; for Splicing Connectors

207 Series

Packaging Instructions

Note on Packaging Unit (PU) and Subpackaging Unit (SPU):

If you order a full PU, you will receive our eco-friendly, sustainable cardboard blisters packed in a shelf-ready box.

If you order a quantity smaller than a full PU, you will receive the eco-friendly, sustainable cardboard blisters without a shelf-ready box.



Lift the flap and pull the cover perforation forward.



Press in the perforation on the sides.



Tear off the cover from the perforation.



As a counter display: Bend the rear flap at the fold, straighten it and fix it in the cardboard cut-out



If the flap is not required, tear off from the perforation.



Self-service shelving system with Euro-slot hang tabs for product display

Junction Boxes; for 221 Series Splicing Connectors (4 mm²) 207 Series Installation



The junction box is designed for surface screw mounting on the wall/ceiling. The cover can be snapped on and off without screws. The connectors are easily mounted by snapping them in, and the marking strips are mounted by simply pushing them in.



Snap the connector into the holder.



Release the connector from the holder.

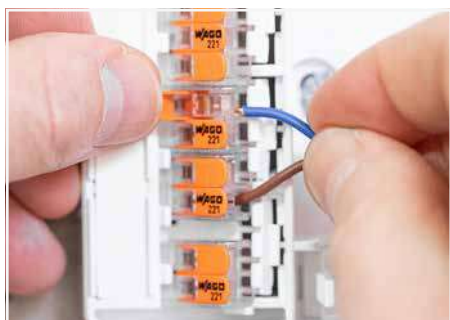

Inserting a conductor



Snap the marking strips into the holder.



Insert the cable into the strain relief. The snap-in strain reliefs are designed for cable diameters from 4 mm to 11 mm.



Break the cable entry lid out of the cover.



Snap on the junction box cover.



Open the junction box cover.

Junction Box; for 221 Series Splicing Connectors (4 mm²) 207 Series

Technical Data

Dimensions (width x height x depth): 225 x 46 x 145 mm

Protection type: IP20

Current supply: 18 A (max.)

Operating voltage: 450 V (max.)

DEKRA test report per EN and BS 60670-22

Designed for up to 60 connection points



Junction box; for 221 Series splicing connectors – 4 mm²
(221-41x, not included in delivery)

Color	Item No.	Pack. Unit
<input type="radio"/> white	207-4301	1

Accessories; 207 Series

Accessory set; consists of 6 double-deck strain reliefs
and marking strips



207-9301 1

Inline Splicing Connectors

221 Series

Installation



Push up the lever to open the clamping unit and insert the conductor.



Push the lever back down.

Your Benefits:

- Inline connection of solid, stranded and fine-stranded conductors from 0.2 to 4 mm²
- Slim design needs minimum space in tight areas
- Tool-free connection and disconnection thanks to convenient lever technology
- Use a mounting carrier for fixed and multi-pole wiring

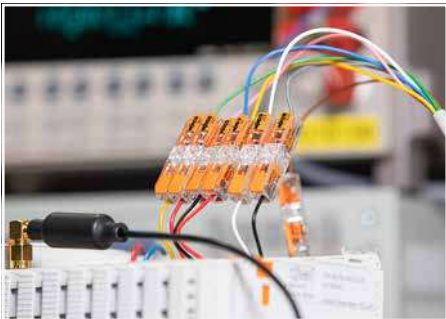

Perfect for test setups

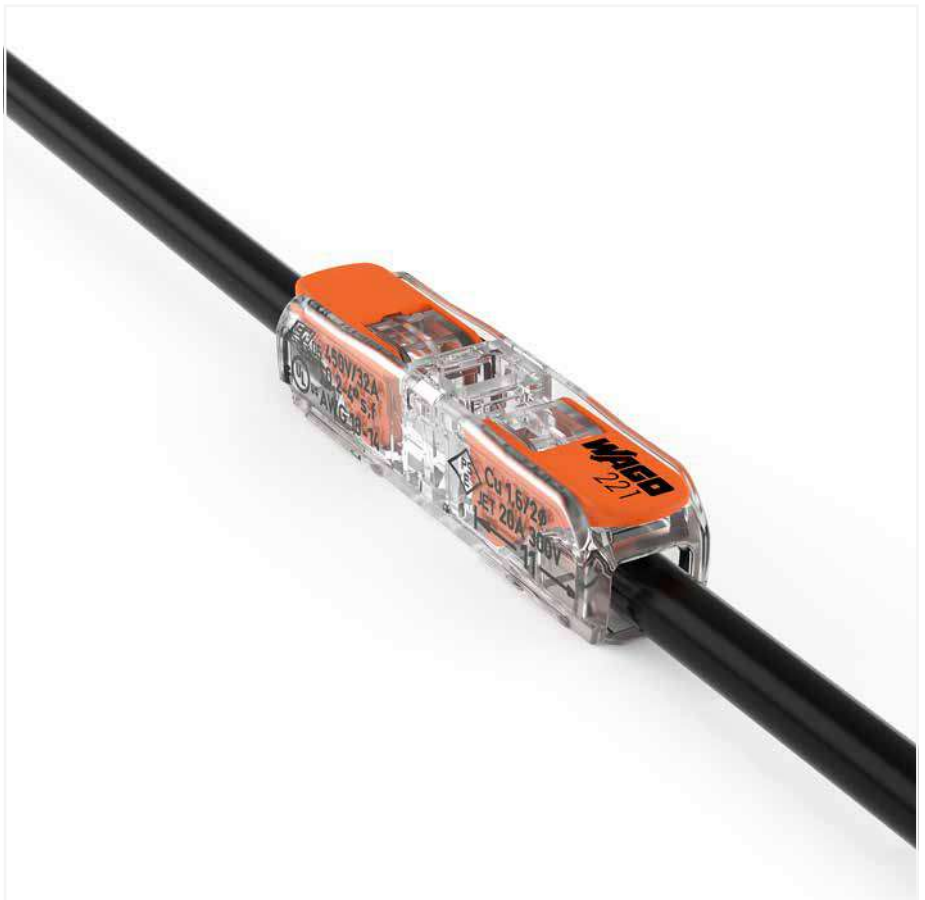

13



Simple extension of lines



Lighting connection in suspended ceilings



Multi-pole, fixed lighting fixture wiring

CAGE CLAMP® terminates the following copper conductors:
solid "s" stranded "st"

fine-stranded "f-st", also with tinned single strands

fine-stranded, tip-bonded

Inline Splicing Connector 221 Series

Technical Data	
0.2 ... 4 mm ² "s"	20 ... 14 AWG "s"
0.2 ... 2.5 mm ² "st"	18 ... 14 AWG "st"
0.2 ... 4 mm ² "f-st"	18 ... 14 AWG "f-st"
450 V / 4 kV / 2 ①	600 V, 20 A ②
I _N 32 A	
11 mm / 0.43 inch	

Technical Data	
0.2 ... 4 mm ² "s"	20 ... 12 AWG "s"
0.2 ... 2.5 mm ² "st"	18 ... 12 AWG "st"
0.34 ... 4 mm ² "f-st"	18 ... 12 AWG "f-st"
450 V / 4 kV / 2 ①	600 V, 20 A ②
I _N 32 A	
11 mm / 0.43 inch	

① 450 V = rated voltage
 4 kV = rated impulse voltage
 2 = pollution degree
 (see Section 15)

Approvals and corresponding ratings,
 visit www.wago.com



Dimensions in mm

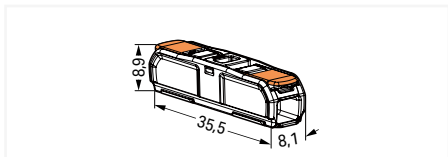

Inline splicing connector with levers; transparent housing; transparent cover		
	Item No.	Pack. Unit
	221-2411	600 (60)

Dimensions in mm

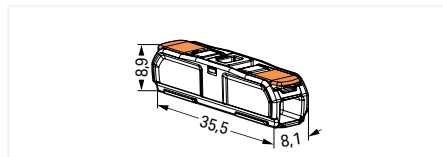

Inline splicing connector with levers; transparent housing; white cover		
	Item No.	Pack. Unit
	221-2401	600 (60)

Mounting Carrier; for Inline Splicing Connectors Installation



Place the inline splicing connector on the carrier in front of the mounting position.



Push the connector to the center position until it snaps into place.



Conductor wiring can also be performed in fixed position.



Various combinations of 1- to 5-connector mounting carriers are possible via side-by-side latching mechanism.

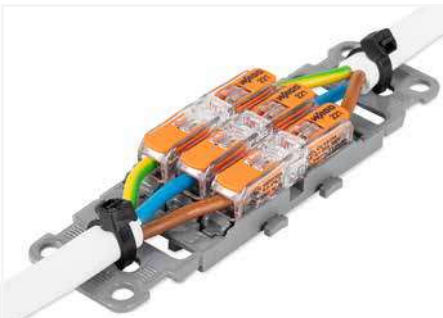

3-pole mounting carrier with strain relief



Mounting carrier without strain relief – snapped onto DIN-rail

Mounting Carrier; for Inline Splicing Connectors 221 Series



Dimensions in mm

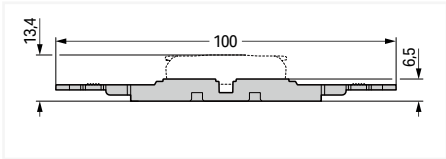

Mounting carrier with strain relief; for inline splicing connector with levers; for screw mounting; gray

	Item No.	Pack. Unit
○ 1x	221-2501	25 (5)
○ 2x	221-2502	25 (5)
○ 3x	221-2503	25 (5)
○ 4x	221-2504	25 (5)
○ 5x	221-2505	25 (5)

Dimensions in mm

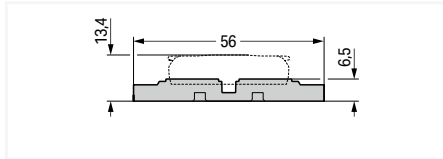

Mounting carrier; for inline splicing connector with levers; for screw mounting; gray

	Item No.	Pack. Unit
○ 1x	221-2521	25 (5)
○ 2x	221-2522	25 (5)
○ 3x	221-2523	25 (5)
○ 4x	221-2524	25 (5)
○ 5x	221-2525	25 (5)

Accessories; 221 Series

Appropriate marking systems:
WMB/WMB Inline/Marking strips

Mounting foot; can be screwed on terminal blocks with mounting flange; for DIN-15 rail; 6.4 mm wide



gray 209-1116 25

Marking strips; on reel; 5 mm wide; plain; self-adhesive; white



white 210-834 100



Dimensions in mm

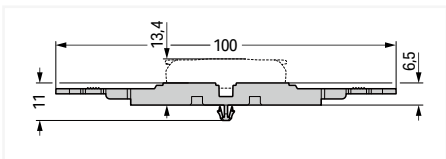

Mounting carrier with strain relief; for inline splicing connector with levers; with snap-in mounting foot; gray

	Item No.	Pack. Unit
○ 1x	221-2511	25 (5)
○ 2x	221-2512	25 (5)
○ 3x	221-2513	25 (5)
○ 4x	221-2514	25 (5)
○ 5x	221-2515	25 (5)

Dimensions in mm

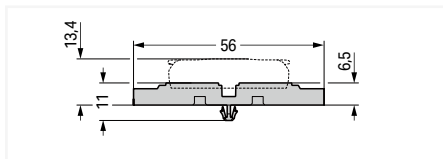

Mounting carrier; for inline splicing connector with levers; with snap-in mounting foot; gray

	Item No.	Pack. Unit
○ 1x	221-2531	25 (5)
○ 2x	221-2532	25 (5)
○ 3x	221-2533	25 (5)
○ 4x	221-2534	25 (5)
○ 5x	221-2535	25 (5)

Accessories; 221 Series

Appropriate marking system: Marking strips

Mounting foot; snaps onto terminal blocks with snap-in mounting foot; for DIN-35 rail; 6.4 mm wide



gray 209-120 25

Mounting foot with screw; can be screwed on terminal blocks with mounting flange; for DIN-35 rail; 6.4 mm wide



gray 209-123 25

Mounting screw; for mounting foot (209-120)



209-119 500 (50)

Mounting foot; snaps onto terminal blocks with snap-in mounting foot; for DIN-15 rail; 6.4 mm wide



gray 209-1115 25

Gelboxes; for 221 Series Inline Splicing Connectors 207 Series Installation



Open the Gelbox at the side latches.



Place the wired connector in the Gelbox.

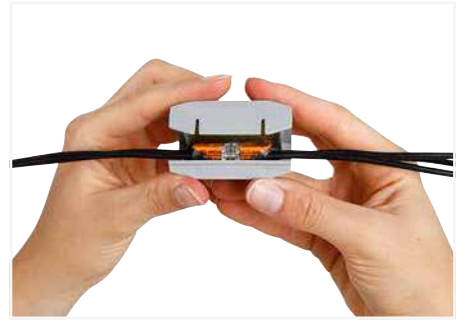

Close the Gelbox.



Close latch securely.



Re-accessible:
Open the Gelbox, remove the gel, open the connector and rewire with new components.

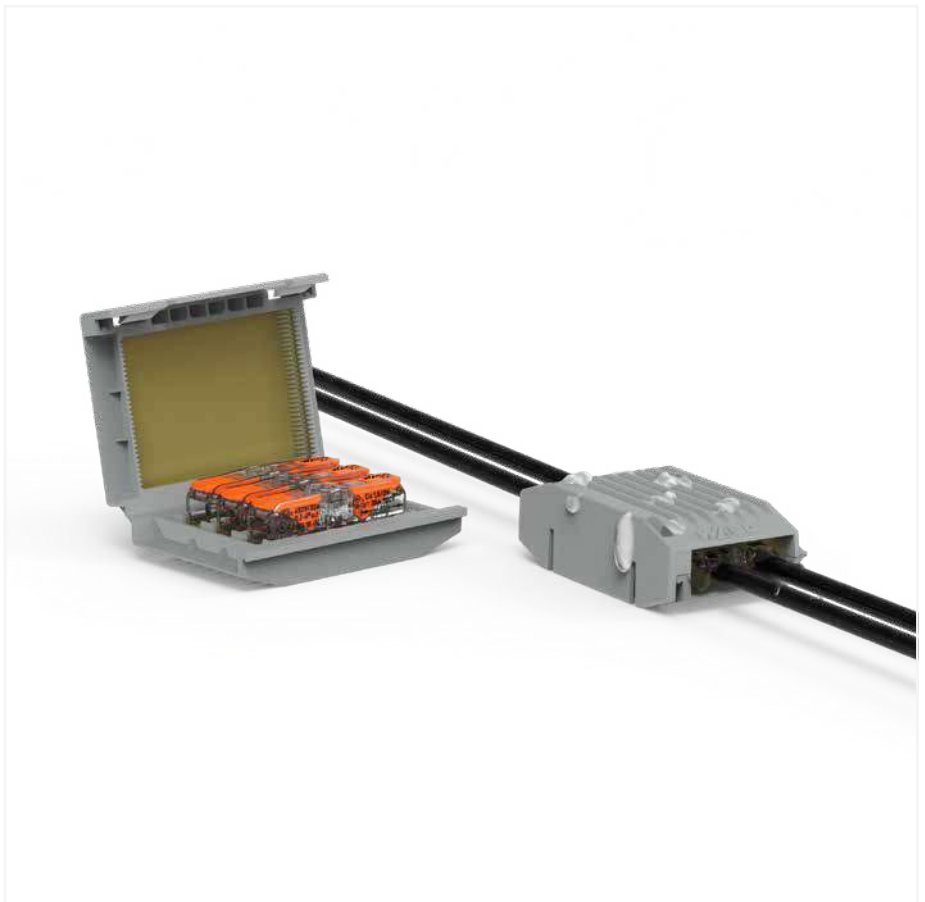

For low voltage applications > 50 V, use the Gelbox in a junction box.



Connecting a path light



Opened Gelbox with connector

13

Gelbox; for 221 Series Inline Splicing Connectors 207 Series

Technical Data

Housing material: Polypropylene

Gel material: Polyurethane

Voltage range: see connector voltage

Rated current: see connector current

Rated surge voltage: 2.5 kV

Insulation resistance: 5 MΩ

Ambient temperature (operation): -55 ... 85 °C

Ambient temperature (storage): 0 ... 40 °C

Physical properties: IPX8

Gel is suitable for indefinite storage, free of hazardous substances according to CLP

Disposal: Household waste (residual waste)

After skin contact: Clean with water, no special cleaning agents necessary

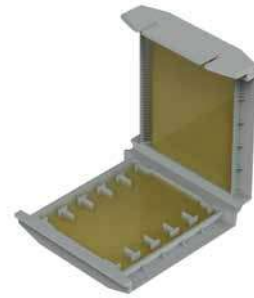
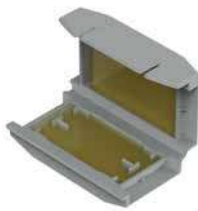

Gelbox; inline connection; for conductors; with gel; 221 Series, max. 4 mm² connectors; without splicing connectors; size 1

Color	Item No.	Pack. Unit
○ gray	207-1372	28 (4)

Gelbox; inline connection; for conductors; with gel; 221 Series, max. 4 mm² connectors; without splicing connectors; size 2

Color	Item No.	Pack. Unit
○ gray	207-1373	28 (4)

Gelbox; inline connection; for conductors; with gel; 221 Series, max. 4 mm² connectors; without splicing connectors; size 3

Color	Item No.	Pack. Unit
○ gray	207-1375	14 (2)

Permitted Combinations of Connectors and Gelbox:

Item Number	221-2411	221-2401
207-1372	2 x 	2 x 
207-1373	3 x 	3 x 
207-1375	5 x 	5 x 

Note: With other combinations, the high degree of protection cannot be guaranteed because the gel displacement is too limited or the Gelboxes can no longer be closed.

CLASSIC Splicing Connectors for All Conductor Types

222 Series

Description and Installation

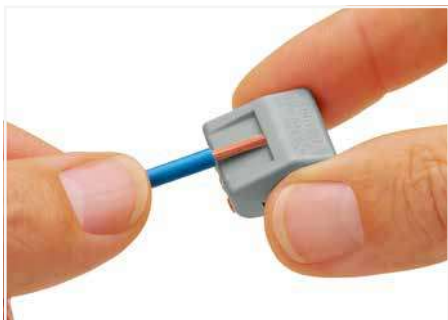

Strip conductor to 9 ... 10 mm (0.35 ... 0.39 inch).

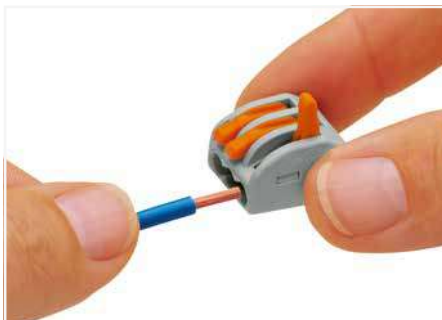

Termination: Lift the lever to open the clamping unit and insert a stripped conductor.

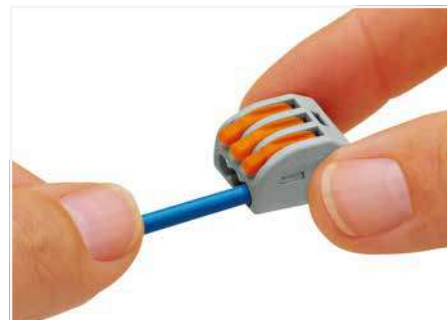

Then, lower the lever to close the clamp.

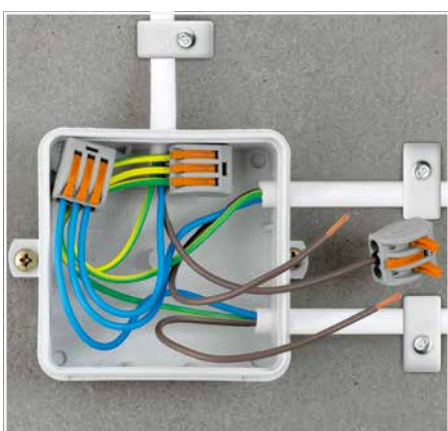

Wiring fine-stranded conductors in a junction box.

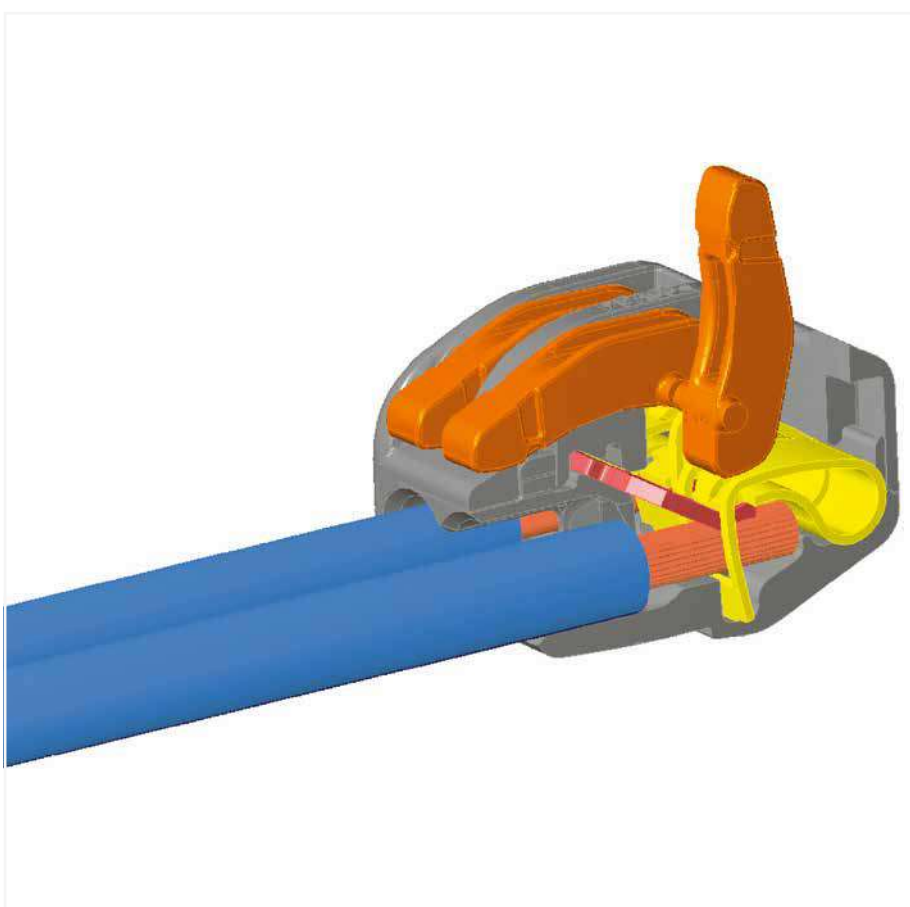

Testing the wired connectors.

CAGE CLAMP® terminates the following copper conductors:
 solid "s" stranded "st"

fine-stranded "f-st", also with tinned single strands

fine-stranded, tip-bonded

fine-stranded, with ferrule (gastight crimped)

fine-stranded, with pin terminal (gastight crimped)

With ferruled conductors, it is necessary to use a terminal block one size smaller than the conductor's nominal cross section.



CLASSIC Splicing Connector for All Conductor Types 2.5 mm²; 222 Series

Technical Data

0.08 ... 2.5 mm ² "s+str"	28 ... 12 AWG "s+st"
0.08 ... 4 mm ² "f-st"	28 ... 12 AWG "f-st"
400 V / 4 kV / 2 ①	600 V, 20 A ②
I _N 32 A	

Technical Data

0.08 ... 2.5 mm ² "s+str"	28 ... 12 AWG "s+st"
0.08 ... 4 mm ² "f-st"	28 ... 12 AWG "f-st"
400 V / 4 kV / 2 ①	600 V, 20 A ②
I _N 32 A	

- ① In grounded power lines
400 V = rated voltage
4 kV = rated impulse voltage
2 = pollution degree
(see Section 15)

Approvals and corresponding ratings,
visit www.wago.com



Dimensions in mm

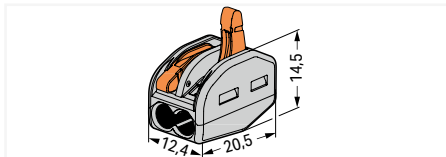

Splicing connector for all conductor types; 2-wire connector; with levers; continuous operating temperature (max.): 85 °C; surrounding air temperature (max.): 40 °C

Color	Item No.	Pack. Unit
○ gray	222-412	500 (50)

Dimensions in mm

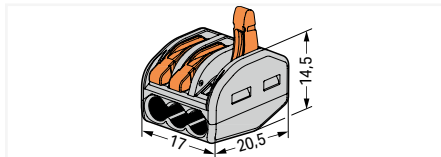

Splicing connector for all conductor types; 3-wire connector; with levers; continuous operating temperature (max.): 85 °C; surrounding air temperature (max.): 40 °C

Color	Item No.	Pack. Unit
○ gray	222-413	500 (50)



Compact, lever-operated splicing connectors:
Tool-free connection of up to five stripped, fine-stranded conductors from 0.08 ... 4 mm² (28 ... 12 AWG), as well as solid or stranded conductors up to 2.5 mm² (12 AWG).

How these work:

Pull up one of the orange operating levers to open the clamping unit so that the lever engages and keeps the clamp in its opened position. Then insert the conductor and push the lever back down, flush with the connector housing.

Safety:

The lever's specially designed rest position reliably prevents accidental unclamping of a connected conductor. Application safety, for any type of conductor (solid, stranded, fine-stranded), is confirmed by approvals like ENEC or UL.

ENEC is the European mark for electrical products that demonstrates compliance with European safety standards. The ENEC mark is subjected to the same EN standards as the VDE mark.

While the VDE mark is only permitted in Germany, the ENEC mark is accepted in more than 20 European countries.



Dimensions in mm

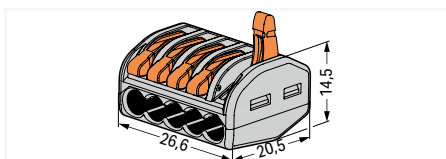

Splicing connector for all conductor types; 5-wire connector; with levers; continuous operating temperature (max.): 85 °C; surrounding air temperature (max.): 40 °C

Color	Item No.	Pack. Unit
○ gray	222-415	400 (40)

Mounting Carrier 222 Series Installation



Horizontal mounting on DIN-35 rail using an angled DIN-rail adapter



Horizontal mounting with strain relief plate on DIN-35 rail using an angled DIN-rail adapter

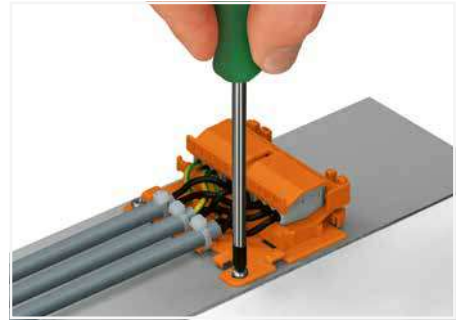

Horizontal screw mounting with strain relief plate on a flat surface



Vertical mounting with strain relief plate on DIN-35 rail; Marking clamping units via marking strips.



Strain relief via cable ties on the mounting carrier (transverse to the connectors' wiring direction); Molded marking clamping units

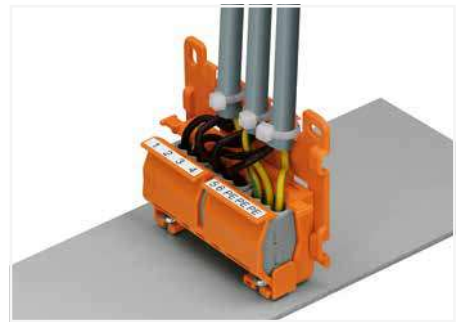

Mounting carrier with strain relief plate mounted vertically on a plate; Round cable secured via strain relief lug.



Snapping the lateral connector safety lock onto the mounting carrier.



Securing a strain relief plate to the mounting carrier.

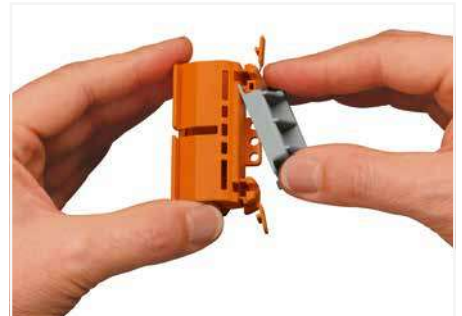

Snapping the angled DIN-rail adapter onto the mounting carrier.

Mounting Carrier 222 Series

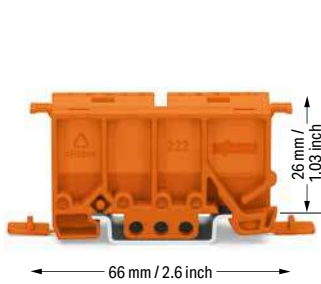

Mounting carrier; for 2-, 3- and 5-wire splicing connectors; 22 mm wide

Color	Item No.	Pack. Unit
● orange	222-500	50 (10)

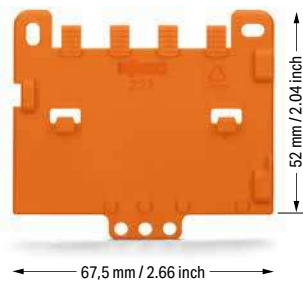

Strain relief plate; for mounting carrier (221 or 222 Series); snaps on to mounting carrier; 4 mm thick

Color	Item No.	Pack. Unit
● orange	222-505	50 (10)

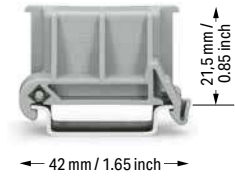

Angled DIN-rail adapter; in combination with mounting carrier (221-500 or 222-500) for DIN-35 rail mounting; 18.5 mm wide

Color	Item No.	Pack. Unit
○ gray	222-510	50 (10)

Accessories; item-specific

Marking strips; on reel; 5 mm wide; plain; self-adhesive; white

	white	210-834	1
---	-------	---------	---

Lighting Connectors; 224 Series

Lighting Side and Installation Side

Description and Installation

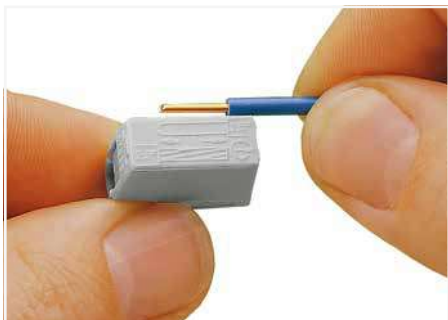

Strip conductor to 9 ... 11 mm (0.35 ... 0.43 inch).



To connect: Press button fully, insert stripped conductor into square entry and release.

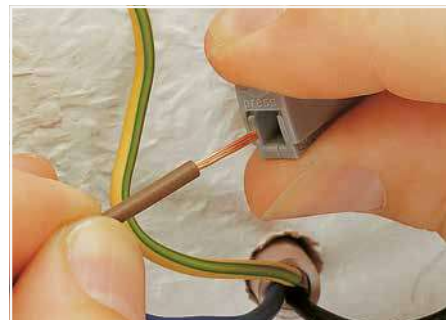

To remove: Press button and withdraw conductor.

Lighting side

CAGE CLAMP® terminates the following copper conductors:

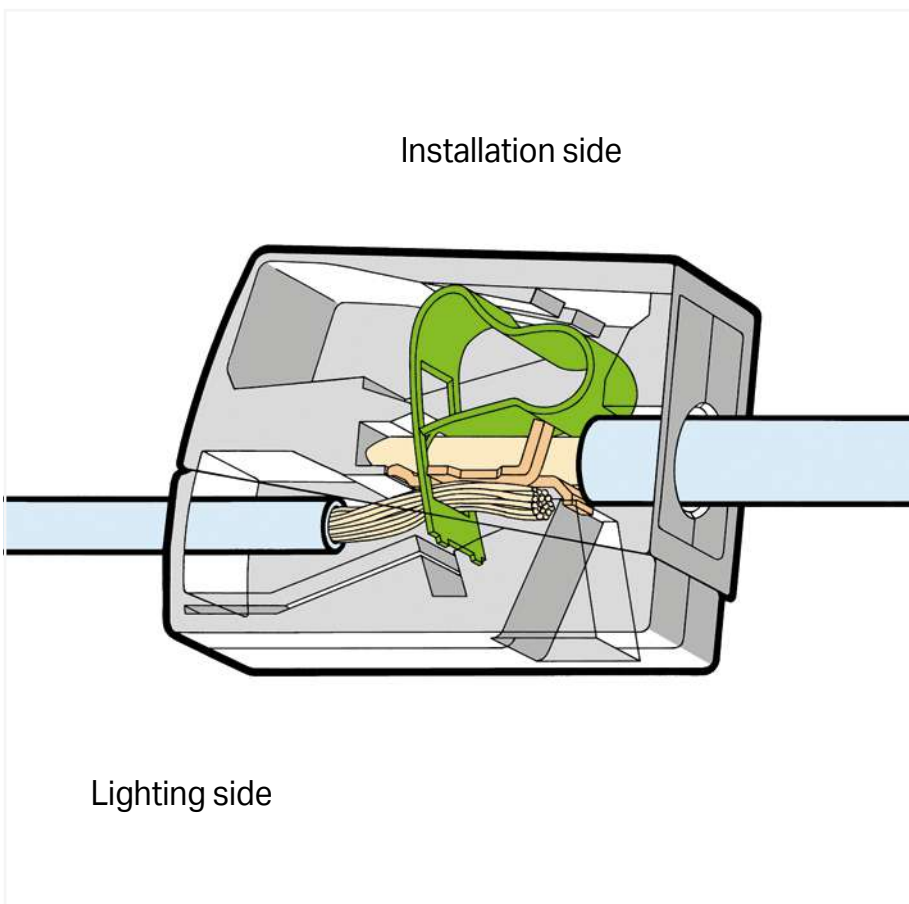
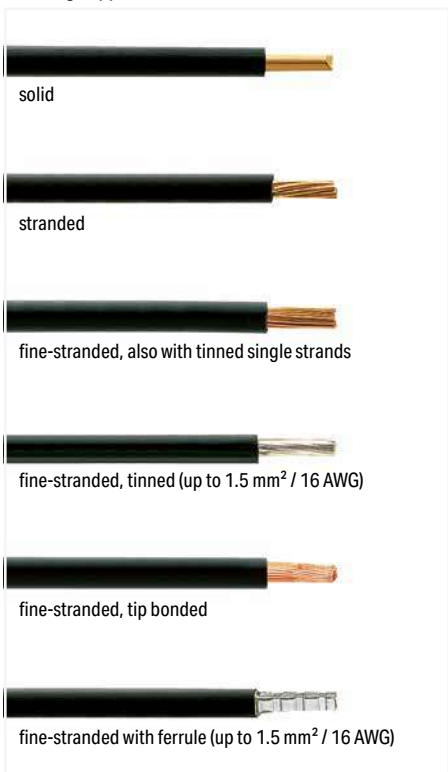

13



To connect: Insert stripped solid conductor into circular entry and push until it hits the backstop.

Installation side



PUSH WIRE® terminates the following copper conductors:
solid "s"

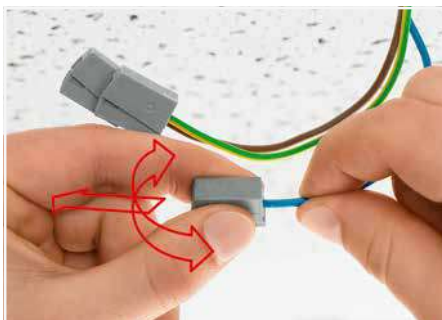

To remove: Hold conductor to be removed and twist alternately left and right while slightly pulling the connector.



Testing via separate test ports.

Lighting Connector and Service Connector 2.5 mm², 224 Series

Technical Data	
Installation side	
1 ... 2.5 mm ² "s"	14 ... 12 AWG
Lighting side	
0.5 ... 2.5 mm ² "s+f-st"	20 ... 16 AWG
400 V / 4 kV / 2	300 V, 20 AⓈ
I _N 24 A	300 V, 20 AⓈ
9 ... 11 mm / 0.35 ... 0.43 inch	

Technical Data	
Installation side	
1 ... 2.5 mm ² "s"	16 ... 14 AWG
Lighting side	
0.5 ... 2.5 mm ² "s+f-st"	20 ... 16 AWG
400 V / 4 kV / 2	300 V, 20 AⓈ
I _N 24 A	300 V, 20 AⓈ
9 ... 11 mm / 0.35 ... 0.43 inch	

Technical Data	
0.5 ... 2.5 mm ² "s+f-st"	20 ... 16 AWG
400 V / 4 kV / 2	300 V, 20 AⓈ
I _N 24 A	
9 ... 11 mm / 0.35 ... 0.43 inch	



Dimensions in mm

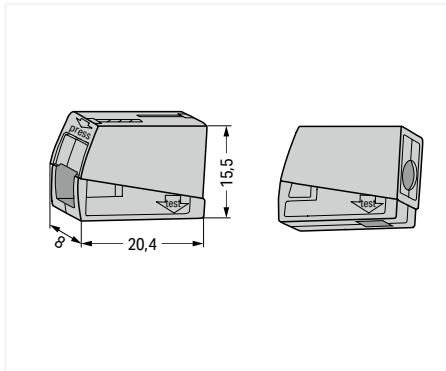

Dimensions in mm

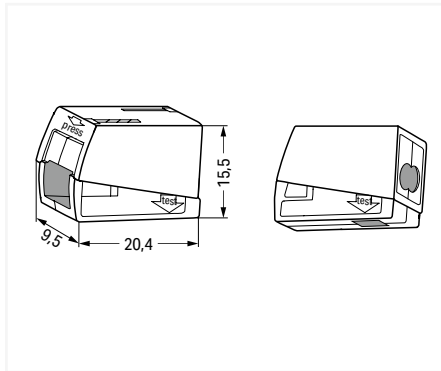

Dimensions in mm

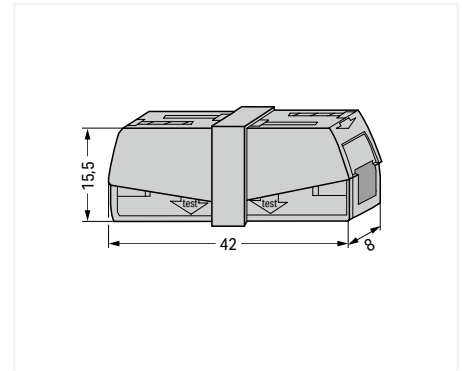

Lighting connector; Standard version; continuous operating temperature (max.): 105 °C; surrounding air temperature (max.): 60 °C

Color	Item No.	Pack. Unit
○ gray	224-101	1000 (100)

2-wire lighting connector; Standard version; continuous operating temperature (max.): 105 °C; surrounding air temperature (max.): 60 °C

Color	Item No.	Pack. Unit
○ white	224-112	1000 (100)

Service connector

Color	Item No.	Pack. Unit
○ gray	224-201	50

Lighting connector; Version for increased continuous operating temperature: 120 °C; surrounding air temperature (max.): 75 °C

● black	224-104	100
---------	---------	-----

2-wire lighting connector; Version for increased continuous operating temperature: 120 °C; surrounding air temperature (max.): 75 °C

● black	224-114	100
---------	---------	-----

Accessories; 224 Series

Syringe; contains 20 ml "Alu-Plus" Contact Paste

249-130	20 (5)
---------	--------



Splicing Connector Set 887 Series



Splicing connector set; Vario-T-BOXX; 222, 224, 243, 2273 Series

Item No.	Pack. Unit
887-910	1

Contains:

CLASSIC splicing connector; 0.08 ... 4 mm²; gray

- 50 x 3-conductor 222-413
- 40 x 5-conductor 222-415

Lighting connector; 1 ... 2.5 mm² "s"; gray

- 100 x 224-101

MICRO PUSH WIRE® connector for junction boxes; Ø 0.6 ... 0.8 mm

- 100 x 4-conductor (dark gray) 243-204
- 100 x 4-conductor (red) 243-804
- 50 x 8-conductor (dark gray) 243-208

COMPACT splicing connector; 0.5 ... 2.5 mm²

- 100 x 2-conductor (white) 2273-202
- 100 x 3-conductor (orange) 2273-203
- 100 x 5-conductor (yellow) 2273-205
- 50 x 8-conductor (light gray) 2273-208

Mounting carrier; for 6 connectors; orange

- 10 x 243-113



Splicing connector set; Vario-T-BOXX; 221, 224, 243, 773, 2273 Series

Item No.	Pack. Unit
887-912	1

Contains:

COMPACT splicing connector; 0.2 ... 4 mm²; transparent

- 50 x 3-conductor 221-413
- 25 x 5-conductor 221-415

2-conductor lighting connector; 1 ... 2.5 mm² "s"; white

- 100 x 224-112

MICRO PUSH WIRE® connector for junction boxes; Ø 0.6 ... 0.8 mm

- 100 x 4-conductor (dark gray) 243-204
- 100 x 4-conductor (red) 243-804
- 50 x 8-conductor (dark gray) 243-208

COMPACT splicing connector; 0.5 ... 2.5 mm²

- 100 x 3-conductor (orange) 2273-203
- 100 x 5-conductor (yellow) 2273-205
- 50 x 8-conductor (light gray) 2273-208

PUSH WIRE® connector for junction boxes; 1.5 ... 4 mm² "s"; red

- 100 x 4-conductor 773-604

Mounting carrier; for 6 connectors; orange

- 10 x 243-113



Splicing connector set; L-BOXX® 102; 221, 224, 243, 773, 2273 Series

Item No.	Pack. Unit
887-925	1

Contains:

COMPACT splicing connector; 0.2 ... 4 mm²; transparent

- 100 x 2-conductor 221-412
- 50 x 3-conductor 221-413
- 25 x 5-conductor 221-415

2-conductor lighting connector; 1 ... 2.5 mm² "s"; white

- 100 x 224-112

MICRO PUSH WIRE® connector for junction boxes; Ø 0.6 ... 0.8 mm

- 100 x 4-conductor (dark gray) 243-204
- 50 x 8-conductor (dark gray) 243-208

COMPACT splicing connector; 0.5 ... 2.5 mm²

- 100 x 3-conductor (orange) 2273-203
- 100 x 5-conductor (yellow) 2273-205
- 50 x 8-conductor (light gray) 2273-208

PUSH WIRE® connector for junction boxes; 2.5 ... 6 mm² "s"; red

- 100 x 4-conductor 773-173

Mounting carrier; for 2-, 3- and 5-wire splicing connectors (4 mm²); orange

- 4 x 221-500



Splicing connector set; L-BOXX® 102; 221 Series – 4 mm² and 6 mm²

Item No.	Pack. Unit
887-928	1

Contains:

COMPACT splicing connector; 0.2 ... 4 mm²; transparent

- 100 x 2-conductor 221-412
- 250 x 3-conductor 221-413
- 25 x 5-conductor 221-415

COMPACT splicing connector; 0.5 ... 6 mm²; transparent

- 30 x 3-conductor 221-613

Mounting carrier; for 2-, 3- and 5-wire splicing connectors (4 mm²); orange

- 10 x 221-500



Splicing connector set; L-BOXX® 102; 221 Series – 4 mm² and 6 mm²

Item No.	Pack. Unit
887-931	1

Contains:

COMPACT splicing connector; 0.2 ... 4 mm²; transparent

- 100 x 2-conductor 221-412
- 250 x 3-conductor 221-413
- 50 x 5-conductor 221-415

COMPACT splicing connector; 0.5 ... 6 mm²; transparent

- 50 x 2-conductor 221-612
- 30 x 3-conductor 221-613
- 5 x 5-conductor 221-615

Mounting carrier; for 2-, 3- and 5-wire splicing connectors (4 mm²); orange

- 2 x 221-500

Mounting carrier; for 2-, 3- and 5-wire splicing connectors (6 mm²); orange

- 2 x 221-510



Splicing connector set; L-BOXX® 102; 221 Series

Item No.	Pack. Unit
887-934	1

Contains:

COMPACT splicing connector; 0.2 ... 4 mm²; transparent

- 100 x 2-conductor 221-412
- 200 x 3-conductor 221-413
- 50 x 5-conductor 221-415

Mounting carrier; for 2-, 3- and 5-wire splicing connectors (4 mm²); orange

- 5 x 221-500

Inline splicing connector with lever; 0.2 ... 4 mm²; transparent

- 60 x 221-2411

Mounting carrier with strain relief; gray

- 2 x 2-way 221-2502
- 2 x 3-way 221-2503

Splicing Connector Set 887 Series



Splicing connector set; L-BOXX® 102; 221, 2273 Series

Item No.	Pack. Unit
887-926	1

Contains:

- COMPACT splicing connector; 0.2 ... 4 mm²; transparent
- 100 x 2-conductor 221-412
 - 100 x 3-conductor 221-413
 - 25 x 5-conductor 221-415

COMPACT splicing connector; 0.5 ... 2.5 mm²

- 100 x 2-conductor (white) 2273-202
- 100 x 3-conductor (orange) 2273-203
- 100 x 4-conductor (red) 2273-204
- 100 x 5-conductor (yellow) 2273-205
- 50 x 8-conductor (light gray) 2273-208

Mounting carrier; for 2-, 3- and 5-wire splicing connectors (4 mm²); orange

- 2 x 221-500

Mounting carrier; for single- and double-row connectors; orange

- 2 x 2273-500



Splicing connector set; L-BOXX® 102; 221 Series

Item No.	Pack. Unit
887-927	1

Contains:

- COMPACT splicing connector; 0.2 ... 4 mm²; transparent
- 100 x 2-conductor 221-412
 - 250 x 3-conductor 221-413
 - 50 x 5-conductor 221-415

Mounting carrier; for 2-, 3- and 5-wire splicing connectors (4 mm²); orange

- 10 x 221-500



Splicing connector set; L-BOXX® 102; 221, 2273, 207 Series

Item No.	Pack. Unit
887-932	1

Contains:

- COMPACT splicing connector; 0.2 ... 4 mm²; transparent
- 100 x 2-conductor 221-412
 - 50 x 3-conductor 221-413
 - 25 x 5-conductor 221-415

COMPACT splicing connector; 0.5 ... 2.5 mm²

- 100 x 2-conductor (white) 2273-202
- 100 x 3-conductor (orange) 2273-203
- 100 x 5-conductor (yellow) 2273-205

Inline splicing connector with lever; 0.2 ... 4 mm²; transparent

- 60 x 221-2411

Mounting carrier; for 2-, 3- and 5-wire splicing connectors (4 mm²)

- 2 x orange 221-500
- 1 x blue 221-500/000-006
- 1 x dark gray-yellow 221-500/000-053

Jumper; 2-way

- 5 x dark gray 221-941
- 5 x blue 221-942/000-006

Gelbox; 221, 2x73 Series; max. 4 mm²; gray

- 1 x Size 1 207-1331
- 1 x Size 2 207-1332
- 1 x Size 3 207-1333

Mounting carrier; for single- and double-row connectors; orange

- 2 x 2273-500

Mounting carrier with strain relief; gray

- 2 x 3-way 221-2503



Splicing connector set; L-BOXX MICRO; 221, 2273 Series

Item No.	Pack. Unit
887-802	1

Contains:

- COMPACT splicing connector; 0.2 ... 4 mm²; transparent
- 10 x 2-conductor 221-412
 - 20 x 3-conductor 221-413
 - 8 x 5-conductor 221-415

COMPACT splicing connector; 0.5 ... 2.5 mm²

- 50 x 3-conductor (orange) 2273-203
- 20 x 5-conductor (yellow) 2273-205
- 12 x 8-conductor (light gray) 2273-208

Mounting carrier; for 2-, 3- and 5-wire splicing connectors (4 mm²); orange

- 1 x 221-500

Mounting carrier; for single- and double-row connectors; orange

- 1 x 2273-500



Splicing connector set; L-BOXX® MICRO; 221, 2273 Series

Item No.	Pack. Unit
887-803	1

Contains:

- COMPACT splicing connector; 0.2 ... 4 mm²; transparent
- 20 x 2-conductor 221-412
 - 35 x 3-conductor 221-413
 - 8 x 5-conductor 221-415

Inline splicing connector with lever; 0.2 ... 4 mm²; transparent

- 30 x 221-2411

Splicing Connector Set 887 Series



Splicing connector set; L-BOXX® MICRO; 221 Series

Item No.	Pack. Unit
887-804	1

Contains:

- COMPACT splicing connector; 0.2 ... 4 mm²; transparent
- 15 x 2-conductor 221-412
 - 20 x 3-conductor 221-413
 - 8 x 5-conductor 221-415

- Mounting carrier; for 2-, 3- and 5-wire splicing connectors (4 mm²); orange
- 1 x 221-500

- COMPACT splicing connector; 0.5 ... 6 mm²; transparent
- 5 x 2-conductor 221-612
 - 5 x 3-conductor 221-613

- Inline splicing connector with lever; 0.2 ... 4 mm²; transparent
- 15 x 221-2411

- Mounting carrier with strain relief; gray
- 1 x 3-way 221-2503



Splicing connector set; L-BOXX® MICRO; 221, 2273, 207 Series

Item No.	Pack. Unit
887-805	1

Contains:

- COMPACT splicing connector; 0.2 ... 4 mm²; transparent
- 10 x 2-conductor 221-412
 - 20 x 3-conductor 221-413
 - 8 x 5-conductor 221-415

- Mounting carrier; for 2-, 3- and 5-wire splicing connectors (4 mm²); orange
- 1 x 221-500

- COMPACT splicing connector; 0.5 ... 2.5 mm²
- 50 x 3-conductor (orange) 2273-203
 - 20 x 5-conductor (yellow) 2273-205
 - 12 x 8-conductor (light gray) 2273-208

- Mounting carrier; for single- and double-row connectors; orange
- 1 x 2273-500



Splicing connector set; L-BOXX® Mini; 221 Series

Item No.	Pack. Unit
887-850	1

Contains:

- COMPACT splicing connector; 0.2 ... 4 mm²; transparent
- 100 x 2-conductor 221-412
 - 100 x 3-conductor 221-413
 - 25 x 5-conductor 221-415

- Mounting carrier; for 2-, 3- and 5-wire splicing connectors (4 mm²); orange
- 2 x 221-500

- Inline splicing connector with lever; 10.2 ... 4 mm²; transparent
- 30 x 221-2411

- Mounting carrier with strain relief; gray
- 1 x 2-way 221-2502
 - 1 x 3-way 221-2503



Splicing connector set; L-BOXX® Mini; 221, 2273, 207 Series

Item No.	Pack. Unit
887-853	1

Contains:

- COMPACT splicing connector; 0.2 ... 4 mm²; transparent
- 50 x 3-conductor 221-413

- COMPACT splicing connector; 0.5 ... 6 mm²; transparent
- 30 x 3-conductor 221-613

- COMPACT splicing connector; 0.5 ... 2.5 mm²
- 100 x 3-conductor (orange) 2273-203
 - 100 x 4-conductor (red) 2273-205

- Gelbox; 221, 2x73 Series; max. 4 mm²; gray
- 1 x Size 1 207-1331
 - 1 x Size 2 207-1332
 - 1 x Size 3 207-1333

- Gelbox; 221 Series; max. 6 mm²; gray
- 1 x Size 1 207-1431



Splicing connector set; L-BOXX® Mini; 221, 2273 Series

Item No.	Pack. Unit
887-955	1

Contains:

- COMPACT splicing connector; 0.2 ... 4 mm²; transparent
- 75 x 2-conductor 221-412
 - 50 x 3-conductor 221-413
 - 25 x 5-conductor 221-415

- COMPACT splicing connector; 0.5 ... 2.5 mm²
- 100 x 3-conductor (orange) 2273-203
 - 75 x 5-conductor (yellow) 2273-205
 - 25 x 8-conductor (light gray) 2273-208

- Mounting carrier; for 2-, 3- and 5-wire splicing connectors (4 mm²); orange
- 1 x 221-500

- Mounting carrier; for single- and double-row connectors; orange
- 1 x 2273-500

Splicing connector set; L-BOXX® Mini; 221 Series – 4 mm² and 6 mm²

Item No.	Pack. Unit
887-957	1

Contains:

- COMPACT splicing connector; 0.2 ... 4 mm²; transparent
- 75 x 2-conductor 221-412
 - 50 x 3-conductor 221-413
 - 25 x 5-conductor 221-415

- COMPACT splicing connector; 0.5 ... 6 mm²; transparent
- 40 x 2-conductor 221-612
 - 30 x 3-conductor 221-613
 - 15 x 5-conductor 221-615

- Mounting carrier; for 2-, 3- and 5-wire splicing connectors (4 mm²); orange
- 1 x 221-500

Splicing Connector Set 887 Series



Splicing connector set; L-BOXX® Mini; 221 Series

Item No.	Pack. Unit
887-851	1

Contains:

COMPACT splicing connector; 0.2 ... 4 mm²; transparent

- 50 x 2-conductor 221-412
- 100 x 3-conductor 221-413
- 25 x 5-conductor 221-415

COMPACT splicing connector; 0.5 ... 6 mm²; transparent

- 25 x 3-conductor 221-613

Inline splicing connector with lever; 0.2 ... 4 mm²; transparent

- 30 x 221-2411



Splicing connector set; L-BOXX® Mini; 221 Series

Item No.	Pack. Unit
887-952	1

Contains:

COMPACT splicing connector; 0.2 ... 4 mm²; transparent

- 100 x 2-conductor 221-412
- 100 x 3-conductor 221-413
- 25 x 5-conductor 221-415

Mounting carrier; for 2-, 3- and 5-wire splicing connectors (4 mm²); orange

- 4 x 221-500



Splicing connector set; L-BOXX® Mini; 2273 Series

Item No.	Pack. Unit
887-953	1

Contains:

COMPACT splicing connector; 0.5 ... 2.5 mm²

- 100 x 2-conductor (white) 2273-202
- 100 x 3-conductor (orange) 2273-203
- 100 x 4-conductor (red) 2273-204
- 75 x 5-conductor (yellow) 2273-205
- 25 x 8-conductor (light gray) 2273-208

Mounting carrier; for single- and double-row connectors; orange

- 4 x 2273-500

Splicing connector set; L-BOXX® Mini; 221 Series – 4 mm² and 6 mm²

Item No.	Pack. Unit
887-959	1

Contains:

COMPACT splicing connector; 0.2 ... 4 mm²; transparent

- 100 x 2-conductor 221-412
- 100 x 3-conductor 221-413
- 25 x 5-conductor 221-415

COMPACT splicing connector; 0.5 ... 6 mm²; transparent

- 30 x 3-conductor 221-613



Splicing connector set; L-BOXX® Mini; 221, 2273, 224 Series

Item No.	Pack. Unit
887-960	1

Contains:

COMPACT splicing connector; 0.2 ... 4 mm²; transparent

- 20 x 2-conductor 221-412
- 15 x 3-conductor 221-413
- 10 x 5-conductor 221-415

COMPACT splicing connector; 0.5 ... 6 mm²; transparent

- 5 x 3-conductor 221-613

2-conductor lighting connector; 1 ... 2.5 mm² "s"; white

- 15 x 224-112



COMPACT splicing connector; 0.5 ... 2.5 mm²



- 40 x 2-conductor (white) 2273-202
- 30 x 3-conductor (orange) 2273-203
- 25 x 4-conductor (red) 2273-204
- 20 x 5-conductor (yellow) 2273-205
- 15 x 8-conductor (light gray) 2273-208

PUSH WIRE®

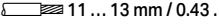
Luminaire Disconnect Connector (U.S. Version)

12 AWG; 873 Series

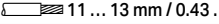
Technical Data	
2-conductor plug ①	1-conductor socket ②
18 ... 12 AWG "s"	18 AWG "s"
16 ... 12 AWG "st"	600 V, 6 A
 11 ... 13 mm / 0.43 ... 0.51 inch ①	
 9 ... 11 mm / 0.35 ... 0.43 inch ②	

Technical Data	
2-conductor plug ①	1-conductor socket ②
18 ... 12 AWG "s"	18 AWG "s"
16 ... 12 AWG "st"	600 V, 6 A
 11 ... 13 mm / 0.43 ... 0.51 inch ①	
 9 ... 11 mm / 0.35 ... 0.43 inch ②	

- ① 2-conductor plug
 - ② 1-conductor socket
- Approvals and corresponding ratings, visit www.wago.com

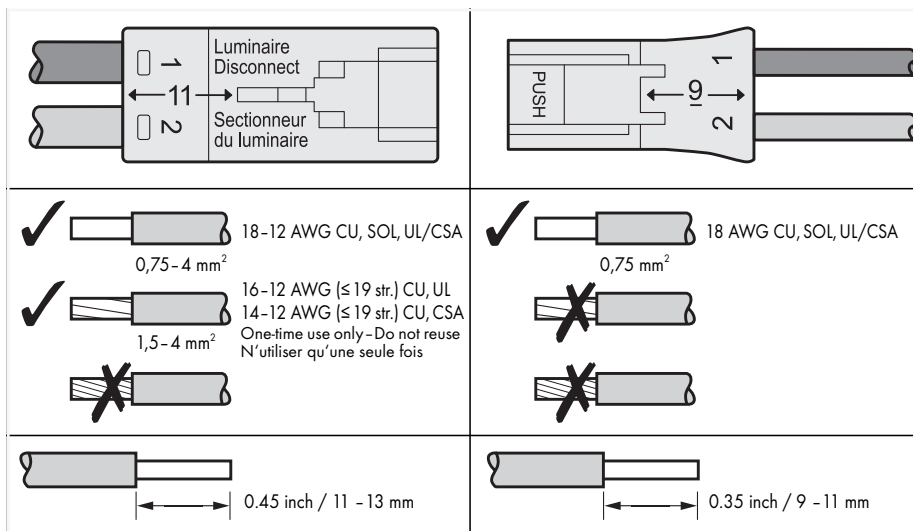
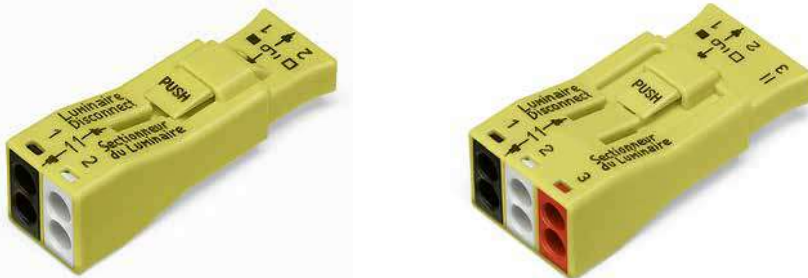

Touchproof connectors are required for ballast supply cables in the USA and Canada. When exchanging a ballast:

1. The touch-proof plug-in connection is disconnected first.
2. The ballast is replaced.
3. Network connection is restored by plugging the connection.

Reconnection streamlines ballast replacement while enhancing safety by safeguarding the installer from electric shock. The 873 Series is approved according to UL 2459 and CSA 22.2 for this type of application.

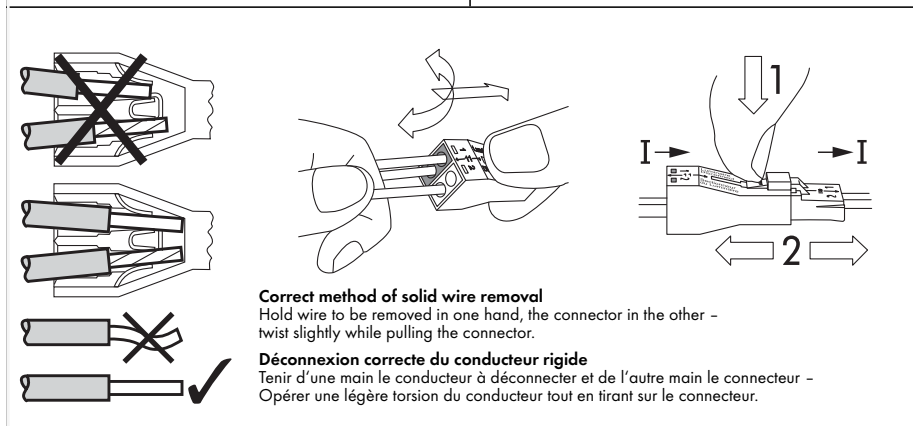

873 Series approvals per EN 60998 and EN 61984:

EN 60998
0.75 mm² (solid), 6 A for socket
1.5 ... 4 mm² (solid), 32 A for plug
400 V / 4 kV / 2



EN 61984
0.75 mm² (solid), 6 A for socket
0.75 ... 4 mm² (solid), 32 A for plug
400 V / 4 kV / 2

Luminaire Disconnect Connectors		
Pole No.	Item No.	Pack. Unit
2	873-902	400

Luminaire Disconnect Connectors		
Pole No.	Item No.	Pack. Unit
3	873-903	200

13

Luminaire Disconnect Connector (U.S. Version) 12 AWG; 873 Series

Technical Data	
2-conductor plug ❶	1-conductor socket ❷
18 ... 12 AWG "s"	18 AWG "s"
16 ... 12 AWG "st"	600 V, 6 A
 11 ... 13 mm / 0.43 ... 0.51 inch ❶	
 9 ... 11 mm / 0.35 ... 0.43 inch ❷	



- ❶ 2-conductor plug
 - ❷ 1-conductor socket
- Approvals and corresponding ratings, visit www.wago.com

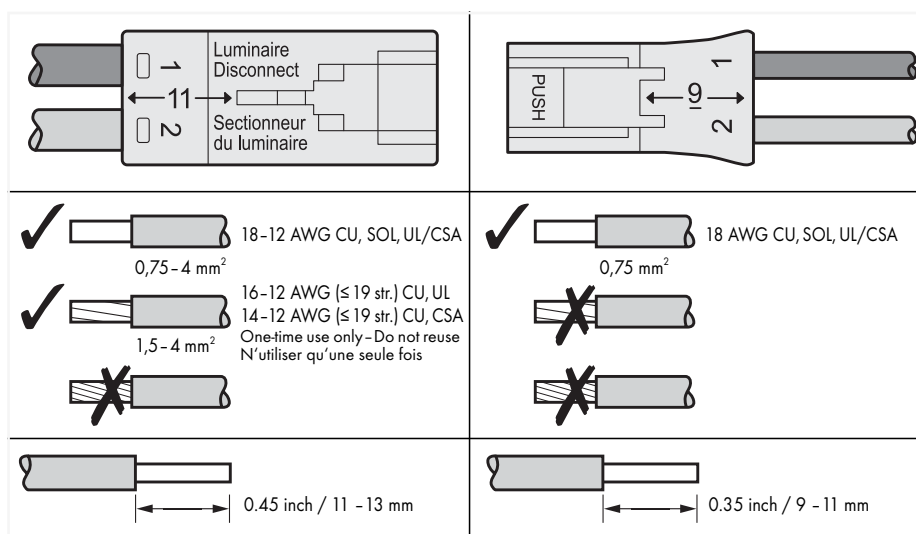

Touchproof connectors are required for ballast supply cables in the USA and Canada. When exchanging a ballast:

1. The touch-proof plug-in connection is disconnected first.
2. The ballast is replaced.
3. Network connection is restored by plugging the connection.

Reconnection streamlines ballast replacement while enhancing safety by safeguarding the installer from electric shock. The 873 Series is approved according to UL 2459 and CSA 22.2 for this type of application.

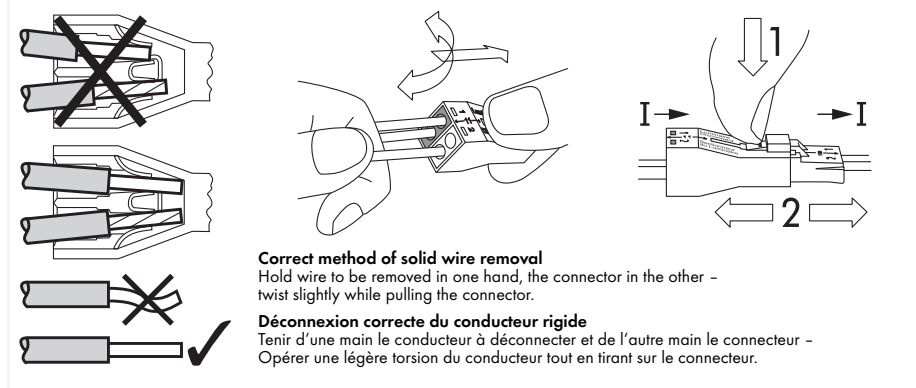

873 Series approvals per EN 60998 and EN 61984:

EN 60998
0.75 mm² (solid), 6 A for socket
1.5 ... 4 mm² (solid), 32 A for plug
400 V / 4 kV / 2













EN 61984
0.75 mm² (solid), 6 A for socket
0.75 ... 4 mm² (solid), 32 A for plug
400 V / 4 kV / 2

Luminaire disconnect connector; with preceding ground contact		
Pole No.	Item No.	Pack. Unit
2	873-953	500



WAGO Accessories and WAGO Tools

WAGO Accessories and WAGO Tools

			Page
	Shield Clamping Saddles	790 Series	668
	Spring-Equipped Shield Clamping Saddles	790 Series	671
	Busbar Carriers	790 Series	673
	Marking Systems		684
	DIN-Rails, Collective Jumper Carriers and Rail-Mount Terminal Block Covers		700
	End Stops for DIN-35 and DIN-15 Rails		702
	Operating tools		708
	Cable Strippers		710
	Crimping Tools for Ferrules		714
	Cable Cutter		720
	Test and Measurement Devices		721
	"Alu-Plus" Contact Paste		724

Shield Connection System

790 Series

Installation



Carrier with grounding foot* (790-113), 45 mm long, busbar 90° to the rail

*for all shield clamping saddle sizes



Carrier with grounding foot* (790-114), 45 mm long, busbar parallel to the rail

*for all shield clamping saddle sizes



Carrier with grounding foot* (790-115), 125 mm long, busbar parallel to the rail

*for all shield clamping saddle sizes



Securing a spacer sleeve to a specialty slotted DIN-rail.



Securing an additional shield clamping saddle.

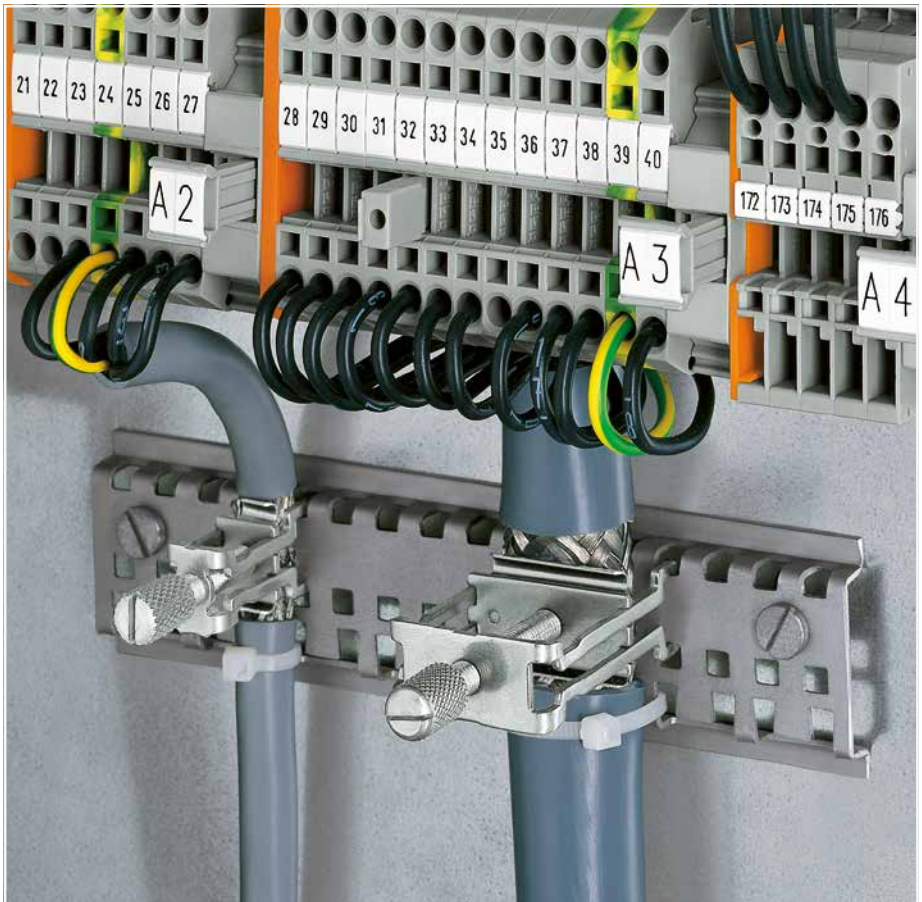

Tightening/removing a shield clamping saddle.



After connection, tighten the knurled screw to complete the installation.
Recommended tightening torque: 0.5 Nm



To remove the clamping saddle, unscrew until ratcheted mechanism is released, then slightly tip saddle and remove the clamping saddle.

Shield Connection System

790 Series

Installation



Carrier with grounding foot – busbar parallel to the rail



Insulated mounting carriers for a common shield reference potential, independent of housing potential



U-shaped (10 x 3) mm copper busbar

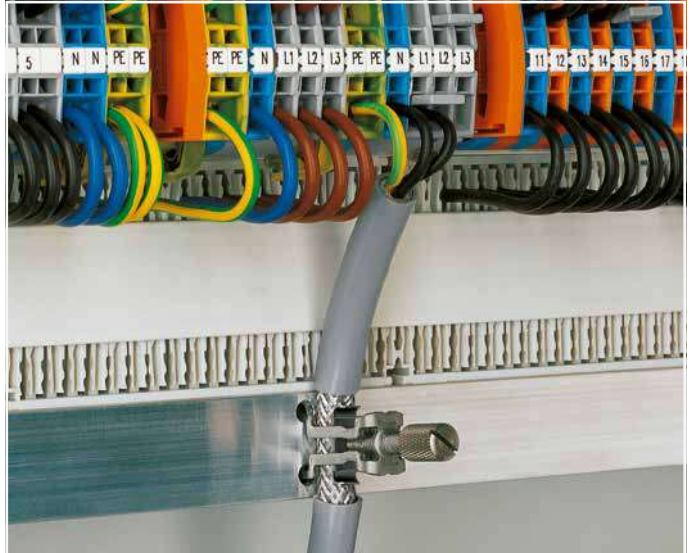

Snap shield clamping saddles into any metal plate (max. thickness: 3 mm).

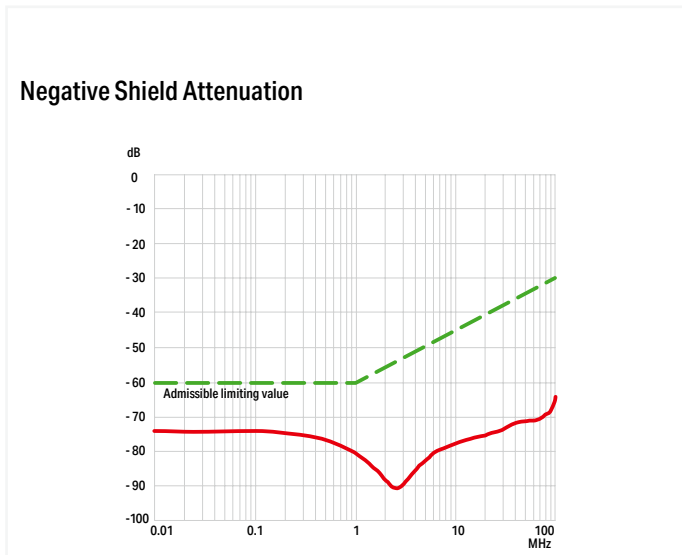

The shield connection system is highly effective because the clamping unit can be brought very close to the unshielded part of the cable.

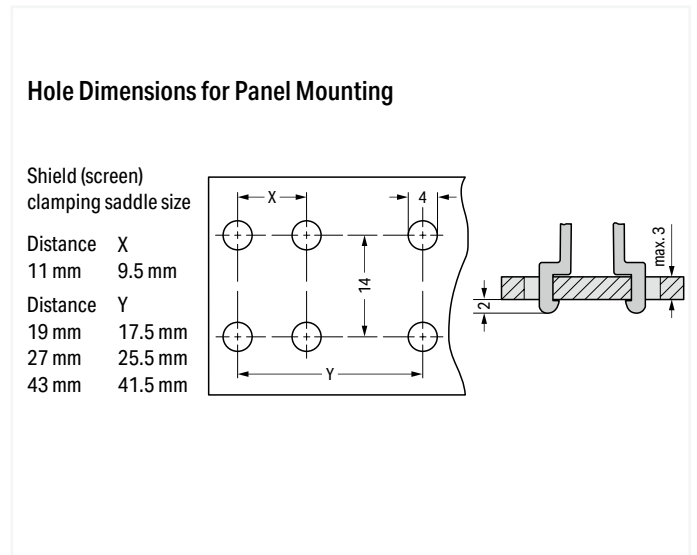

Additionally, the spring material is part of the clamping saddle, providing a good electrical connection (the system also acts as a partial strain relief). The spring element integrated in the shield clamping saddle compensates for deformation and settling that results from a connected shield.

Shield Clamping Saddles 790 Series

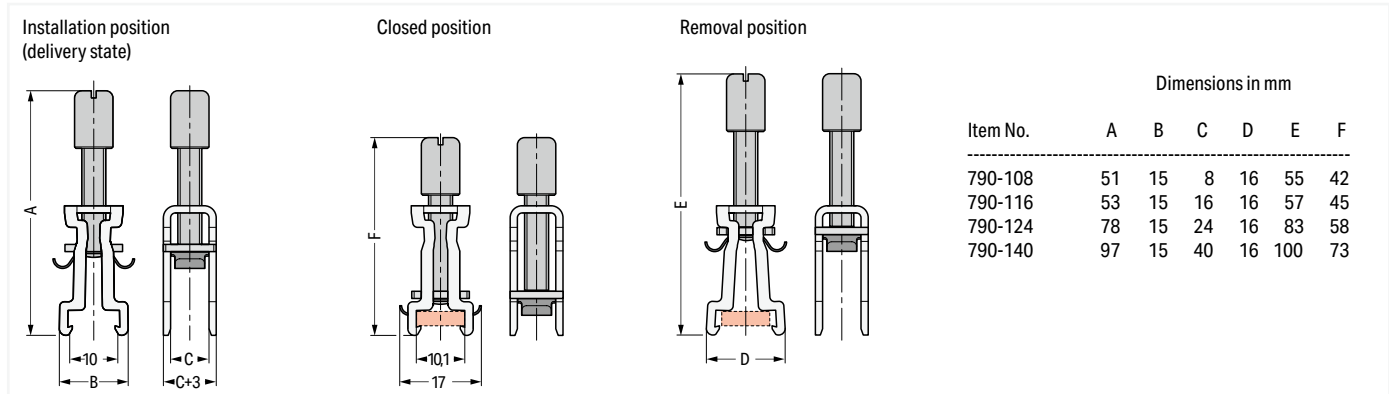

Item No.	Dimensions in mm					
	A	B	C	D	E	F
790-108	51	15	8	16	55	42
790-116	53	15	16	16	57	45
790-124	78	15	24	16	83	58
790-140	97	15	40	16	100	73

Shield clamping saddle; 11 mm wide; Connectable shield diameter: 3 ... 8 mm Note: Cannot be used for connecting ground conductors!	Shield clamping saddle; 19 mm wide; Connectable shield diameter: 7 ... 16 mm Note: Cannot be used for connecting ground conductors!	Shield clamping saddle; 27 mm wide; Connectable shield diameter: 6 ... 24 mm Note: Cannot be used for connecting ground conductors!
Item No. 790-108 Pack. Unit 50 (10)	Item No. 790-116 Pack. Unit 50 (10)	Item No. 790-124 Pack. Unit 50 (10)

Accessories; for Shield Clamping Saddles

Carrier with grounding foot; Busbar parallel to the rail; 15 mm long; Copper (10 x 3) mm; for shield clamping saddles (790-108) 790-110 25	DIN-rail; specialty slotted; 1000 mm long; tin-plated 790-145	U-shaped busbar; Copper (10 x 3) mm; for 5 I/O; for 750 Series I/O Modules 790-190 25 (5)
Carrier with grounding foot; Busbar parallel to the rail; 25 mm long; Copper (10 x 3) mm; for shield clamping saddles (790-108; 790-116) and shield clamps (791-111; 791-117) 790-112 25	Spacer sleeve; steel; for DIN-rail; specialty slotted; for M5-size screw; 790-144 200 (100)	U-shaped busbar; Copper (10 x 3) mm; for 8 I/O; for 750 Series I/O Modules 790-191 25
Carrier with grounding foot; Busbar 90° to the DIN-rail; 45 mm long; Copper (10 x 3) mm; for shield clamping saddles (790 Series) 790-113 25	Insulated mounting foot; for busbar with M4 x 8 mm screw 790-100 50 (25)	U-shaped busbar; Copper (10 x 3) mm; for 5 I/O; for 750 Series I/O Modules 790-192 25
Carrier with grounding foot; Busbar parallel to the DIN-rail; 45 mm long; Copper (10 x 3) mm; for shield clamping saddles (790 Series) and shield clamps (791 Series) 790-114 25	Insulated mounting foot; for busbar with (3.5 x 9) mm sheet metal screw 790-101 50 (25)	U-shaped busbar; Copper (10 x 3) mm; for 8 I/O; for 750 Series I/O Modules 790-193 25
Carrier with two grounding feet; Busbar parallel to the DIN-rail; 125 mm long; Copper (10 x 3) mm 790-115 25	Busbar; tin-plated; 1000 mm long; copper (10 x 3) mm 210-133 1	
	Busbar; tin-plated; 30 mm long; copper (10 x 3) mm 790-133 20	
	Busbar; tin-plated; 50 mm long; copper (10 x 3) mm 790-134 20	

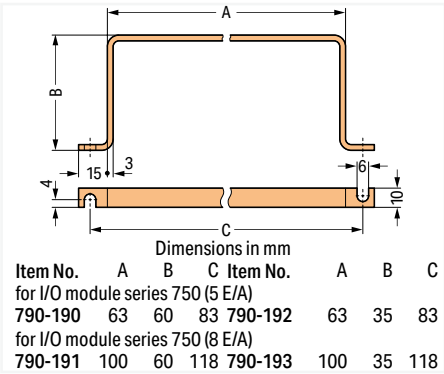

Shield clamping saddle; 43 mm wide; Connectable shield diameter: 22 ... 40 mm
 Note: Cannot be used for connecting ground conductors!

Item No.	Pack. Unit
790-140	50 (10)



Carrier with grounding foot* (790-114), 45 mm long, busbar parallel to the rail

*for all shield clamping saddle sizes



Carrier with grounding foot* (790-115), 125 mm long, busbar parallel to the rail

*for all shield clamping saddle sizes

Spring-Equipped Shield Clamping Saddles

790 Series

Installation



Shield clamping saddles are available in three different sizes for shield diameters ranging from 3 to 20 mm.

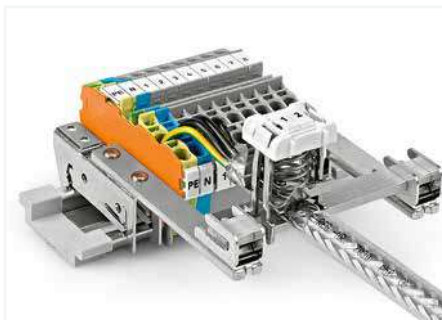

Application example



Compress the clamping saddle until fully engaged.



Mounting a clamping saddle on a specialty slotted DIN-rail (790-145).
When releasing the saddle, do not place your finger under the clamping spring!



Removing the shield clamping saddle.



Shield clamping saddle contacts shield conductor and specialty slotted DIN-rail (790-145).



Labeling using a marking strip.



Labelling using WMB markers.

Spring-Equipped Shield Clamping Saddles 790 Series



Delivery position

Mounting position

Dimensions in mm

Item No.	A	B	C	D	E*
790-208	30	29.9	8	12.4	25.8
790-216	34.6	28.3	16	21.8	30.2
790-220	45.6	28.3	24	30	41.2

*Height with WMB marker

Shield clamping saddle; 12.4 mm wide; Connectable shield diameter: 3 ... 8 mm
 Note: Cannot be used for connecting ground conductors and strain relief!

Item No.	Pack. Unit
790-208	50

Shield clamping saddle; 21.8 mm wide; Connectable shield diameter: 6 ... 16 mm
 Note: Cannot be used for connecting ground conductors and strain relief!

Item No.	Pack. Unit
790-216	25

Shield clamping saddle; 30 mm wide; Connectable shield diameter: 6 ... 20 mm
 Note: Cannot be used for connecting ground conductors and strain relief!

Item No.	Pack. Unit
790-220	25

Accessories; for Shield Clamping Saddles

Carrier with grounding foot; Busbar parallel to the rail; 15 mm long; Copper (10 x 3) mm; for shield clamping saddles (790-108)

790-110	25
---------	----

DIN-rail; specialty slotted; 1000 mm long; tin-plated

790-145	
---------	--

Carrier with grounding foot; Busbar parallel to the rail; 25 mm long; Copper (10 x 3) mm; for shield clamping saddles (790-108; 790-116) and shield clamps (791-111; 791-117)

790-112	25
---------	----

Spacer sleeve; steel; for DIN-rail; specialty slotted; for M5-size screw;

790-144	200 (100)
---------	-----------

Carrier with grounding foot; Busbar 90° to the DIN-rail; 45 mm long; Copper (10 x 3) mm; for shield clamping saddles (790 Series)

790-113	25
---------	----

Busbar; tin-plated; 1000 mm long; copper (10 x 3) mm

210-133	1
---------	---

Carrier with grounding foot; Busbar parallel to the DIN-rail; 45 mm long; Copper (10 x 3) mm; for shield clamping saddles (790 Series) and shield clamps (791 Series)

790-114	25
---------	----

Busbar; tin-plated; 30 mm long; copper (10 x 3) mm

790-133	20
---------	----

Carrier with two grounding feet; Busbar parallel to the DIN-rail; 125 mm long; Copper (10 x 3) mm

790-115	25
---------	----

Busbar; tin-plated; 50 mm long; copper (10 x 3) mm

790-134	20
---------	----

Shield Clamp and Shield Termination 791 and 709 Series



Dimensions in mm

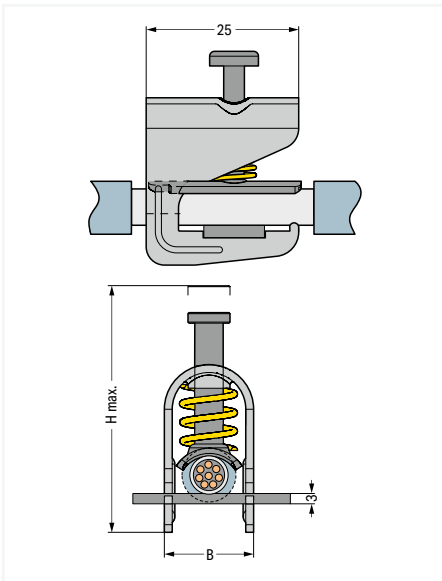

Shield clamp; Connectable shield diameter: 1.5 ... 6.5 mm; Height (max.): 40 mm; 10 mm wide
Note: Cannot be used for connecting ground conductors!

Item No.	Pack. Unit
791-107	50

Shield clamp; Connectable shield diameter: 5 ... 11 mm; Height (max.): 47 mm; 17 mm wide
Note: Cannot be used for connecting ground conductors!

791-111	50
---------	----

Shield clamp; Connectable shield diameter: 10 ... 17 mm; Height (max.): 63 mm; 23 mm wide
Note: Cannot be used for connecting ground conductors!

791-117	50
---------	----

Shield clamp; Connectable shield diameter: 16 ... 24 mm; Height (max.): 78 mm; 30 mm wide
Note: Cannot be used for connecting ground conductors!

791-124	50
---------	----

Shield termination; includes cable ties for 5 ... 10 mm shield diameter; 60 mm long

Item No.	Pack. Unit
709-350	100 (25)

Shield termination; includes cable ties for 5 ... 10 mm shield diameter; 150 mm long

709-352	100 (25)
---------	----------



Insert the shield termination into the female plug using the operating tool.



Fit the shield termination to the shield cable.



Secure both shield cable and shield termination to the strain relief plate using cable ties.



Shield termination connected to an X-COM® female plug

Busbar Carriers 790 Series

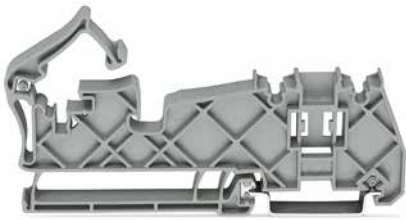

Dimensions in mm

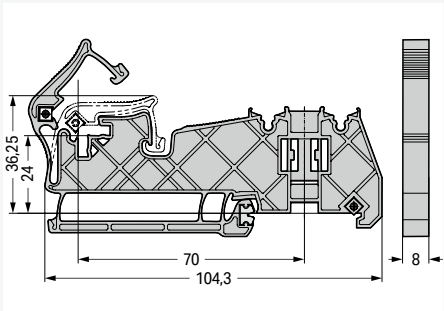

Busbar carrier; for (10 x 3) mm copper busbars; no contact to DIN-rail; insulated

Item No.	Pack. Unit
790-400	20



Snapping the busbar carrier onto DIN-35 rail.



Vertical mounting position of the busbar



Place the busbar in the carrier holder.



Horizontal mounting position of the busbar



Snap the mounting bracket into position.

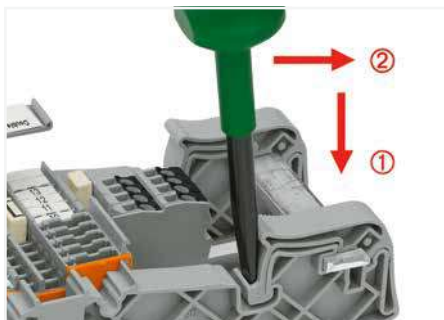

Release the mounting bracket by pushing the operating tool down ① and then forward ②.

Busbar Carriers

790 Series

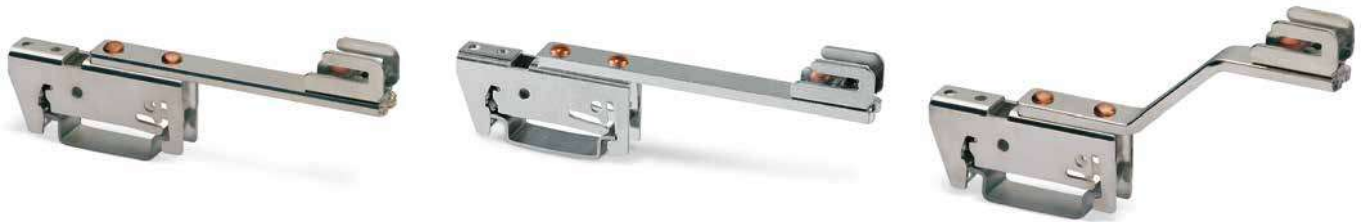

Dimensions in mm

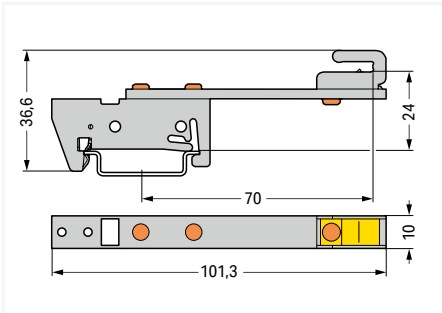

Busbar carrier; for (10 x 3) mm copper busbars; single side; straight; 70 mm between center of DIN-rail and busbar carrier

Item No.	Pack. Unit
790-300	10

Dimensions in mm

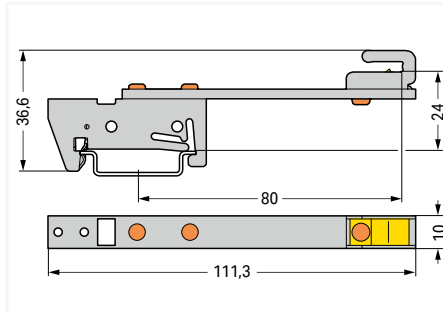

Busbar carrier; for (10 x 3) mm copper busbars; single side; straight; 80 mm between center of DIN-rail and busbar carrier

Item No.	Pack. Unit
790-302	10

Dimensions in mm

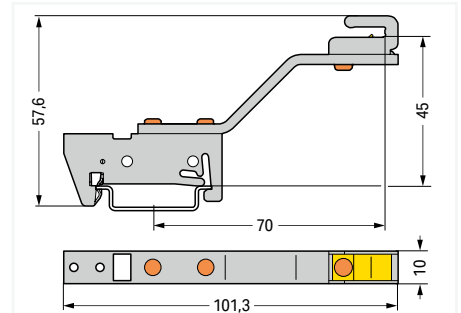

Busbar carrier; for (10 x 3) mm copper busbars; single side; angled; 70 mm between center of DIN-rail and busbar carrier

Item No.	Pack. Unit
790-301	10



Remove the busbar carrier using an operating tool (type 3, 5.5 x 0.8 mm blade).

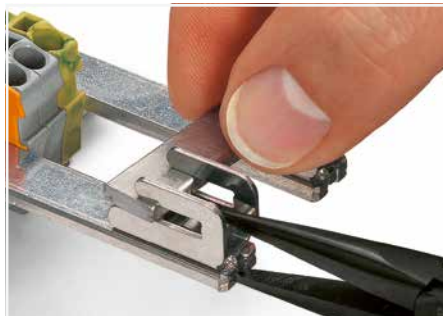

To remove the busbar, compress the spring using pliers.



Place the busbar in the busbar carrier.

Busbar Carriers 790 Series



Dimensions in mm

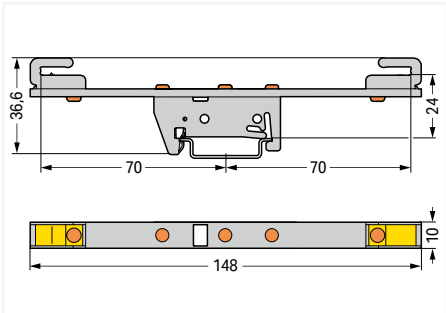

Busbar carrier; for (10 x 3) mm copper busbars; both sides; straight; 70 mm between center of DIN-rail and busbar carrier

Item No.	Pack. Unit
790-310	10

Dimensions in mm

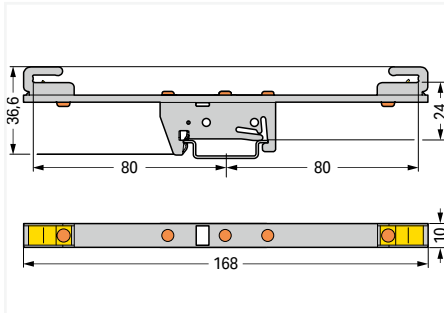

Busbar carrier; for (10 x 3) mm copper busbars; both sides; straight; 80 mm between center of DIN-rail and busbar carrier

Item No.	Pack. Unit
790-312	10

Dimensions in mm

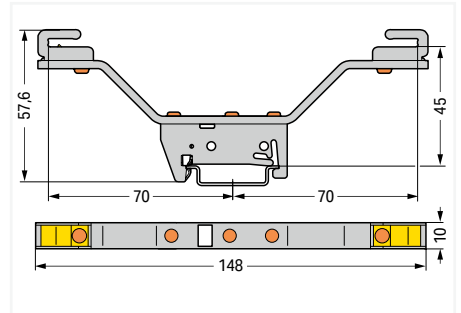

Busbar carrier; for (10 x 3) mm copper busbars; both sides; angled; 70 mm between center of DIN-rail and busbar carrier

Item No.	Pack. Unit
790-311	10

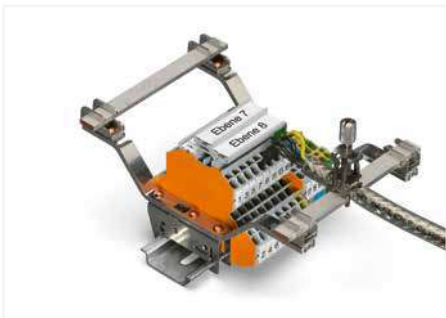

Application example

Busbar Carrier with a T-Connector (Flexible) and T-Connector 790 Series



Dimensions in mm

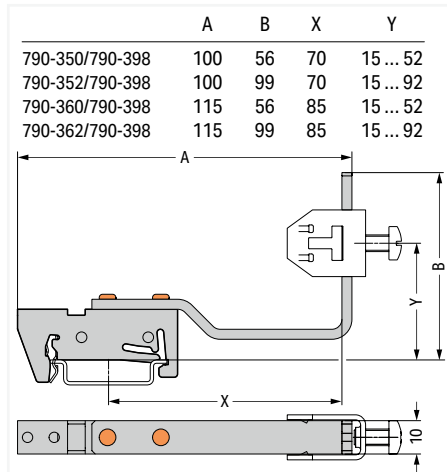

Dimensions in mm

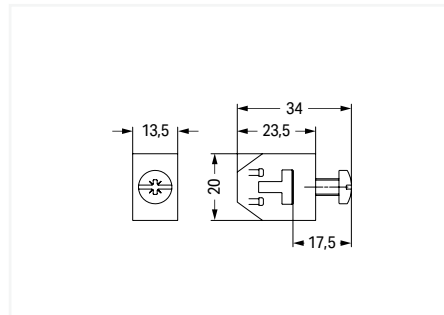

Horizontal mounting position of the busbar



Vertical mounting position of the busbar

Busbar carrier with a T-connector; flexible; for (10 x 3) mm copper busbars; 70 mm between center of DIN-rail and busbar carrier; 56 mm high

	Item No.	Pack. Unit
	790-350/790-398	12

T-connector; connects two (10 x 3) mm copper busbars

	Item No.	Pack. Unit
	790-398	

Busbar carrier with a T-connector; flexible; for (10 x 3) mm copper busbars; 70 mm between center of DIN-rail and busbar carrier; 99 mm high

	790-352/790-398	12
--	-----------------	----

Busbar carrier with a T-connector; flexible; for (10 x 3) mm copper busbars; 85 mm between center of DIN-rail and busbar carrier; 56 mm high

	790-360/790-398	12
--	-----------------	----

Busbar carrier with a T-connector; flexible; for (10 x 3) mm copper busbars; 85 mm between center of DIN-rail and busbar carrier; 99 mm high

	790-362/790-398	12
--	-----------------	----



The height of the busbar can be adjusted.



Secure the busbar by tightening the screws at the required position.

Smart Data

Supports Workflow from Control Cabinet Planning to Installation

Electrical Planning

Directly import data from a CAE circuit diagram into the Smart Designer engineering software or output marking data on Smart Printer

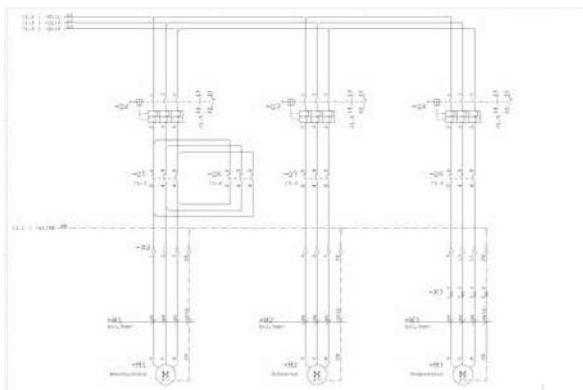

Technical and Commercial Item Data

Classified by ETIM and eCl@ss – also in Advanced Format



Mechanical Planning

CAD export into all standard CAD formats and in different granularities



Smart Designer

- Free online configuration and ordering software for all electrical interconnect and automation components
- No installation required
- Available worldwide – 24 hours a day
- Item data is always updated
- Auto-audit feature checks product compatibility via programmed database
- Design in full 3-D

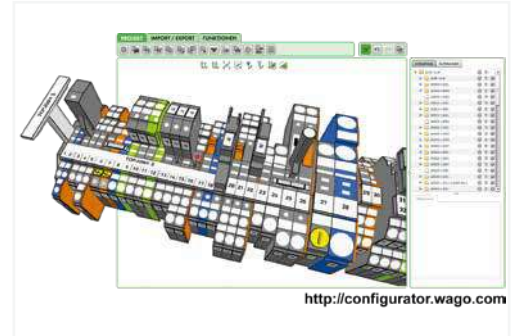

Smart Script

- XML-based software for all WAGO labeling materials
- Data import from CAE systems
- Font size check
- Material selection wizard



Configuration made easy – <http://configurator.wago.com>

Smart Printer

The Fastest Marking System

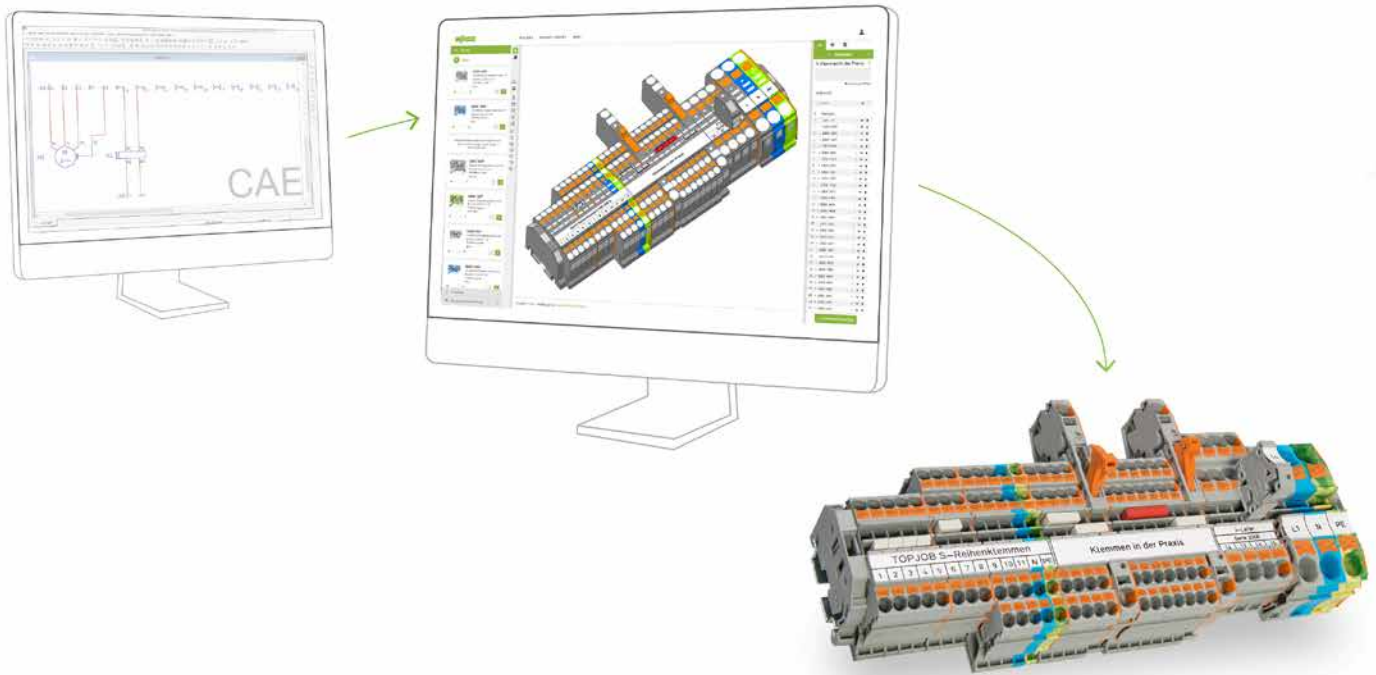

Smart Script

Smart Designer

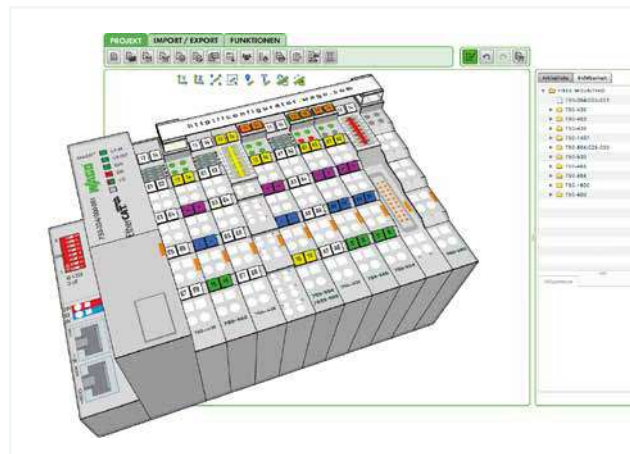

Smart Script
Import from CAE systems or create customized marking.

Smart Designer
After designing, print labeling materials directly from the project via Smart Printer



- Smart Printer
- Compact and easy-to-use
 - Quickly print and install marking strips
 - Cost-effective marking from beginning to end

Terminal Block Marking

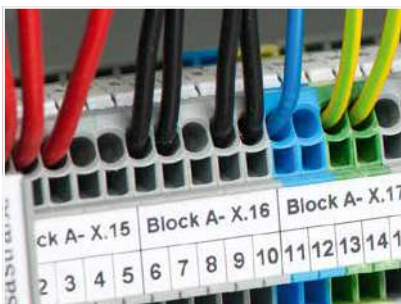

Multi-line marking strips for clear, detailed control cabinet labels

- WMB Inline markers on a reel are suitable for various terminal block sizes – just one marker size for all standard applications
- Same profile across all WAGO Rail-Mount Terminal Blocks TOPJOB® S ensures quick labeling

Cable and Conductor Marking



Different versions available:

- Marking sleeves, self-laminating labels, conductor markers for thread-on mounting or shrink tubes
- Large variety of marking surface sizes

Device Marking

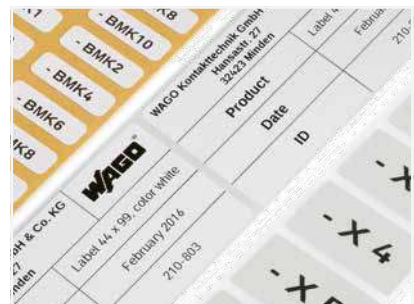

Broad selection of label types (e.g., printable fabric), push-button markers and type plates optimizes marking for devices and control cabinets

- Labels and markers are available in a variety of colors and sizes

Marking Systems

Description and Installation



Separating a strip from the WMB or WMB marker card.



Stretching a WMB marker strip.



Separating an individual marker from the strip – for larger terminal blocks.



Marking via Mini-WSB Quick Marking System.

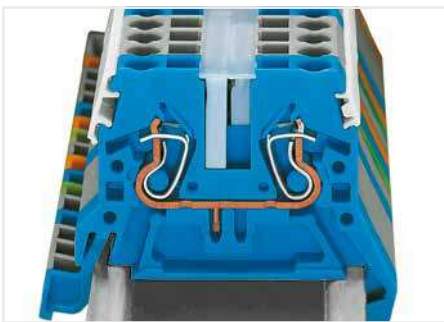

WMB markers in Mini-WSB marker slots
Translucent marking strip
Mini-WSB markers

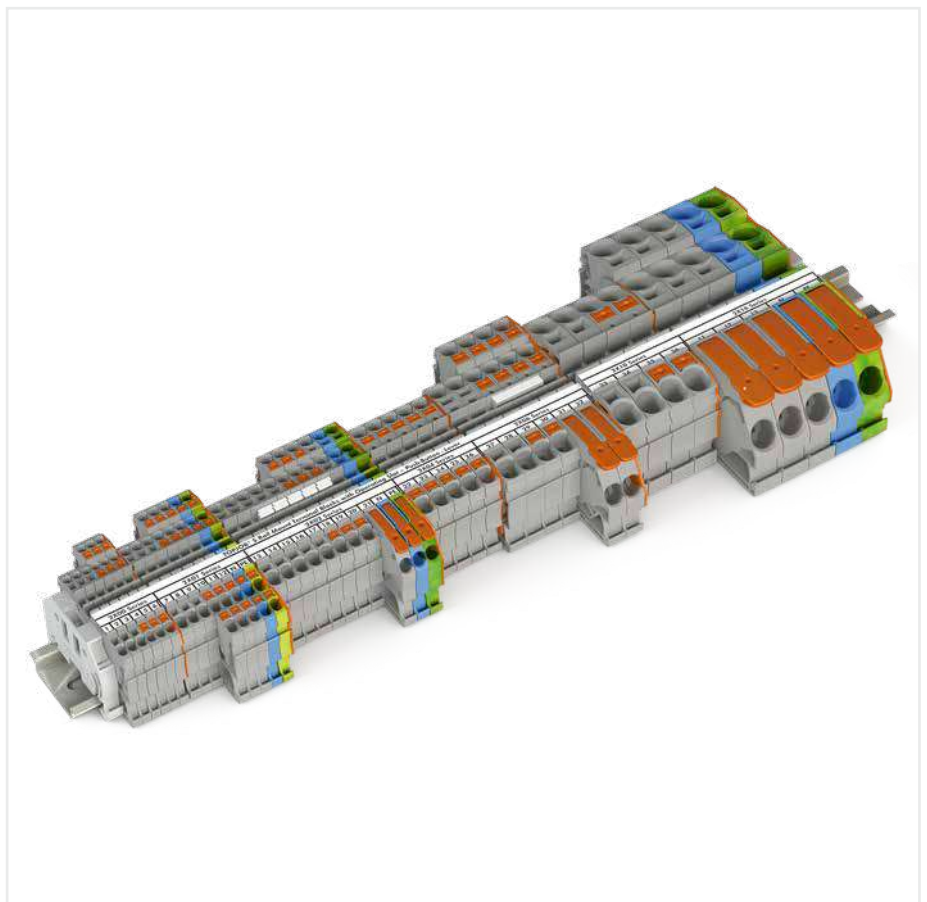

Printing a marking strip (2009-110) via Smart Printer.

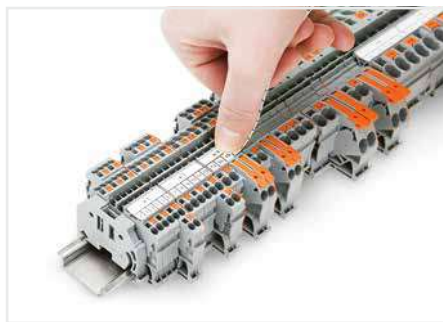

Snapping a marking strip into the marker slot.

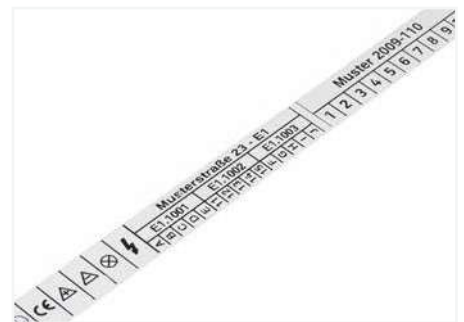

Marking strip – multi-line printing



Snapping a marking strip into the marker slot.



Snapping a WMB marker strip into the marker slot of the double marker carrier.



WMB "decade" marking

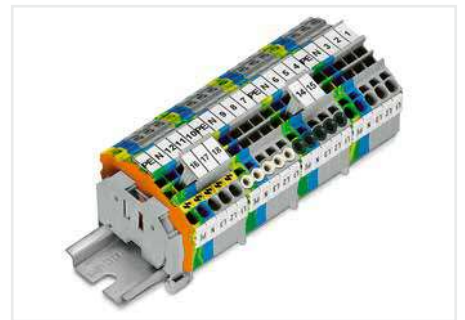

Group marker carriers for WAGO Rail-Mount Terminal Blocks TOPJOB® S – can be snapped into jumper slots.

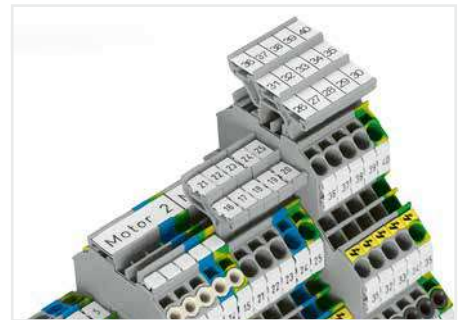

Double- and triple-deck marker carriers can be retrofitted into the jumper contact slot of double- and triple-deck terminal blocks.



Height adjustable group marker carrier (2009-163) for marking strips (2009-110)

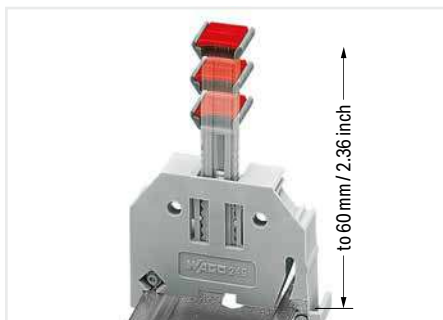

Height-adjustable group marker carrier

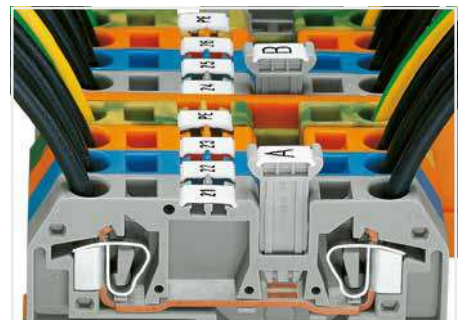

Additional group marking

Marking System

Terminal Block Width: 3.5 mm, 4 ... 4.2 mm and from 5 mm

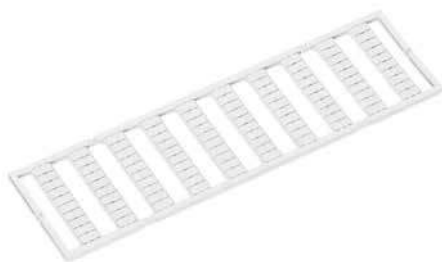

Use		
Marker width	Can be snapped onto the following terminal block series	
	for continuous marking	that will be separated
3.5 mm	2000, 2020	-
4 ... 4.2 mm	279, 2001	-
5 ... 5.2 mm	270, 280, 780, 869, 870, 880, 2002, 2003, 2022	Terminal blocks with spacing > 5 ... 5.2 mm
5 ... 17.5 mm	270, 280, 780, 869, 870, 880	281 ... 285, 781 ... 785, 2002, 2004, 2005, 2006, 2007, 2010, 2016, 2022

WMB marker card; plain; 10 strips with 10 markers/card					
Color	5 mm Item No.	5 ... 5.2 mm Item No.	4 ... 4.2 mm Item No.	3.5 mm Item No.	Pack. Unit
○ white	793-501	793-5501	793-4501	793-3501	5
● yellow	793-501/000-002	793-5501/000-002	793-4501/000-002		5
● red	793-501/000-005	793-5501/000-005	793-4501/000-005		5
● blue	793-501/000-006	793-5501/000-006	793-4501/000-006		5
● gray	793-501/000-007	793-5501/000-007	793-4501/000-007		5
● orange	793-501/000-012	793-5501/000-012	793-4501/000-012		5
● light green	793-501/000-017	793-5501/000-017	793-4501/000-017		5
● green	793-501/000-023	793-5501/000-023	793-4501/000-023		5
● violet	793-501/000-024	793-5501/000-024	793-4501/000-024		5



Use		
Marker width	Can be snapped onto the following terminal block series	
	for continuous marking	that will be separated
3.5 mm	2000, 2020	-
4 ... 4.2 mm	279, 2001	-
5 ... 5.2 mm	270, 280, 780, 869, 870, 880, 2002, 2003, 2022	Terminal blocks with spacing > 5 ... 5.2 mm

WMB Inline; plain; 2,300 WMB markers (3.5 mm)/reel		
Color	3.5 mm Item No.	Pack. Unit
○ white	2009-113	1

WMB Inline; plain; 2,000 WMB markers (4 mm)/reel; stretchable 4 ... 4.2 mm		
Color	4 ... 4.2 mm Item No.	Pack. Unit
○ white	2009-114	1

WMB Inline; plain; 1,500 WMB markers (5 mm)/reel; stretchable 5 ... 5.2 mm		
Color	5 ... 5.2 mm Item No.	Pack. Unit
○ white	2009-115	1



Use		
	Can be snapped onto the following terminal block series	
	2000, 2001, 2002, 2003, 2004, 2005, 2006, 2007, 2010, 2016, 2020, 2022	

Marking strip; plain; 11 mm wide; 50 m reel		
Color	Item No.	Pack. Unit
○ white	2009-110	1

Mini-WSB Quick Marking System

Terminal Block Width: 5 mm

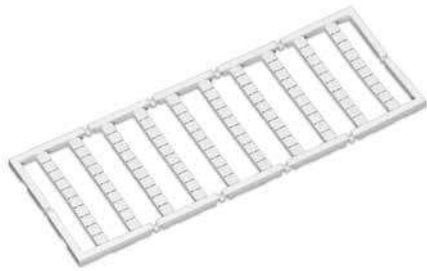

Use		
Marker width	Can be snapped onto the following terminal block series	
	for continuous marking	that will be separated
5 mm	264, 270, 869, 880, 769, 870, 218, 233 ... 236, 243, 250, 252 ... 257, 735 ... 742, 745, 746, 804, 805, 806, 816, 831, 750, 753, 2002, 2003, 2022	745, 746, 2004, 2006, 2007, 2010, 2016

Mini-WSB marker card; plain; 10 strips with 10 markers/card		
Color	Item No.	Pack. Unit
<input type="radio"/> white	248-501	5
<input type="radio"/> yellow	248-501/000-002	5
<input type="radio"/> red	248-501/000-005	5
<input type="radio"/> blue	248-501/000-006	5
<input type="radio"/> gray	248-501/000-007	5
<input type="radio"/> orange	248-501/000-012	5
<input type="radio"/> light green	248-501/000-017	5
<input type="radio"/> green	248-501/000-023	5
<input type="radio"/> violet	248-501/000-024	5

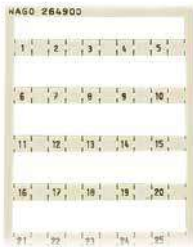

Mini-WSB marker card; with marking; not stretchable; horizontal marking; snap-on type		
Marking	Item No.	Pack. Unit
<input type="radio"/> 1, , 2, , 3, , 4, , 5, ; to 46, , 47, , 48, , 49, , 50, ; (each 1x)	264-900	5
<input type="radio"/> U, , V, , W, , N, , PE, ; (10x)	264-901	5
<input type="radio"/> L1, , L2, , L3, , N, , PE, ; (10x)	264-902	5
<input type="radio"/> 1, , 1, , 1, , 1, , 1, ; (10x)	264-903	5
<input type="radio"/> 2, , 2, , 2, , 2, , 2, ; (10x)	264-904	5
<input type="radio"/> 3, , 3, , 3, , 3, , 3, ; (10x)	264-905	5



Use		
Marker width	Can be snapped onto the following terminal block series	
	for continuous marking	that will be separated
5 mm	264, 270, 869, 880, 769, 870, 218, 233 ... 236, 243, 250, 252 ... 257, 735 ... 742, 745, 746, 804, 805, 806, 816, 831, 750, 753, 2002, 2003, 2022	745, 746, 2004, 2005, 2006, 2007, 2010, 2016

Mini-WSB Inline; plain; 1,700 markers (5 mm)/reel; stretchable 5 ... 5.2 mm		
Color	Item No.	Pack. Unit
<input type="radio"/> white	2009-145	1

Marking Card; Self-Adhesive Marking Strips



- Strip length: 182 mm

Marking strip; plain; as DIN A4 sheet

	Item No.	Pack. Unit
<input type="radio"/> Strip height: 2.3 mm; 100 self-adhesive strips per card	210-331	100
<input type="radio"/> Strip height: 3 mm; 80 self-adhesive strips per card	210-332	100
<input type="radio"/> Strip height: 5 mm; 48 self-adhesive strips per card	210-334	100
<input type="radio"/> Strip height: 6 mm; 40 self-adhesive strips per card	210-333	100
<input type="radio"/> Strip height: 9 mm; 25 self-adhesive strips per card	210-335	100



- Horizontal marking
- Strip length: 182 mm
- Strip height: 6 mm

Marking strip; as DIN A4 sheet; for 2-conductor terminal strips (260 Series)

Marking	Item No.	Pack. Unit
<input type="radio"/> 1 ... 10 (120 x)	210-333/500-002	100
<input type="radio"/> 11 ... 20 (120 x)	210-333/500-003	100
<input type="radio"/> 21 ... 30 (120 x)	210-333/500-004	100
<input type="radio"/> 31 ... 40 (120 x)	210-333/500-005	100
<input type="radio"/> 41 ... 50 (120 x)	210-333/500-006	100
<input type="radio"/> 51 ... 60 (120 x)	210-333/500-007	100
<input type="radio"/> 61 ... 70 (120 x)	210-333/500-008	100
<input type="radio"/> 71 ... 80 (120 x)	210-333/500-009	100
<input type="radio"/> 81 ... 90 (120 x)	210-333/500-010	100
<input type="radio"/> 91 ... 100 (120 x)	210-333/500-011	100
<input type="radio"/> 1 ... 50 (20 x)	210-333/500-021	100
<input type="radio"/> L1 (1440 x)	210-333/500-074	100
<input type="radio"/> L2 (1440 x)	210-333/500-075	100
<input type="radio"/> L3 (1440 x)	210-333/500-076	100
<input type="radio"/> N (1440 x)	210-333/500-077	100
<input type="radio"/> PE (1440 x)	210-333/500-078	100
<input type="radio"/> PEN (1440 x)	210-333/500-079	100
<input type="radio"/> only grid spacing	210-333/500-001	100

Marking strip; for 4-conductor terminal strips (260 Series)

<input type="radio"/> 1 ... 10 (80 x)	210-333/800-002	100
<input type="radio"/> 11 ... 20 (80 x)	210-333/800-003	100
<input type="radio"/> 21 ... 30 (80 x)	210-333/800-004	100
<input type="radio"/> 31 ... 40 (80 x)	210-333/800-005	100
<input type="radio"/> 41 ... 50 (80 x)	210-333/800-006	100
<input type="radio"/> 51 ... 60 (80 x)	210-333/800-007	100
<input type="radio"/> 61 ... 70 (80 x)	210-333/800-008	100
<input type="radio"/> 71 ... 80 (80 x)	210-333/800-009	100
<input type="radio"/> 81 ... 90 (80 x)	210-333/800-010	100
<input type="radio"/> 91 ... 100 (80 x)	210-333/800-011	100
<input type="radio"/> 1 ... 40 (20 x)	210-333/800-209	100
<input type="radio"/> L1 (880 x)	210-333/800-074	100
<input type="radio"/> L2 (880 x)	210-333/800-075	100
<input type="radio"/> L3 (880 x)	210-333/800-076	100
<input type="radio"/> N (880 x)	210-333/800-077	100
<input type="radio"/> PE (880 x)	210-333/800-078	100
<input type="radio"/> PEN (880 x)	210-333/800-079	100
<input type="radio"/> only grid spacing	210-333/800-001	100

Marking Card; Self-Adhesive Marking Strips

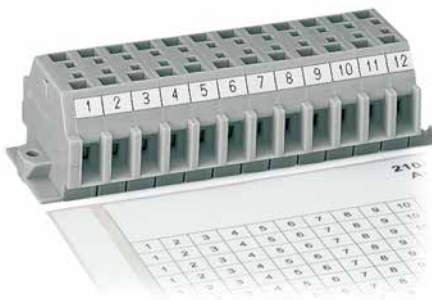

- Horizontal marking
- Strip length: 182 mm
- Strip height: 6 mm

Marking strip; as DIN A4 sheet; for 2-conductor terminal strips (261 Series)

Marking	Item No.	Pack. Unit
<input type="radio"/> 1 ... 12 (80 x)	210-333/600-103	100
<input type="radio"/> 13 ... 24 (80 x)	210-333/600-104	100
<input type="radio"/> 25 ... 36 (80 x)	210-333/600-105	100
<input type="radio"/> 37 ... 48 (80 x)	210-333/600-106	100
<input type="radio"/> 41 ... 50 (80 x)	210-333/600-006	100
<input type="radio"/> 51 ... 60 (80 x)	210-333/600-007	100
<input type="radio"/> 61 ... 70 (80 x)	210-333/600-008	100
<input type="radio"/> 71 ... 80 (80 x)	210-333/600-009	100
<input type="radio"/> 81 ... 90 (80 x)	210-333/600-010	100
<input type="radio"/> 91 ... 100 (80 x)	210-333/600-011	100
<input type="radio"/> 1 ... 50 (20 x)	210-333/600-021	100
<input type="radio"/> L1 (1200 x)	210-333/600-074	100
<input type="radio"/> L2 (1200 x)	210-333/600-075	100
<input type="radio"/> L3 (1200 x)	210-333/600-076	100
<input type="radio"/> N (1200 x)	210-333/600-077	100
<input type="radio"/> PE (1200 x)	210-333/600-078	100
<input type="radio"/> PEN (1200 x)	210-333/600-079	100
<input type="radio"/> only grid spacing	210-333/600-001	100

Marking strip; for 4-conductor terminal strips (261 Series)

<input type="radio"/> 1 ... 16 (40 x)	210-333/1000-202	100
<input type="radio"/> 17 ... 32 (40 x)	210-333/1000-204	100
<input type="radio"/> 33 ... 48 (40 x)	210-333/1000-206	100
<input type="radio"/> 49 ... 64 (40 x)	210-333/1000-110	100
<input type="radio"/> 65 ... 80 (40 x)	210-333/1000-111	100
<input type="radio"/> 81 ... 96 (40 x)	210-333/1000-112	100
<input type="radio"/> 97 ... 112 (40 x)	210-333/1000-113	100
<input type="radio"/> 1 ... 36 (20 x)	210-333/1000-208	100
<input type="radio"/> L1 (720 x)	210-333/1000-074	100
<input type="radio"/> L2 (720 x)	210-333/1000-075	100
<input type="radio"/> L3 (720 x)	210-333/1000-076	100
<input type="radio"/> N (720 x)	210-333/1000-077	100
<input type="radio"/> PE (720 x)	210-333/1000-078	100
<input type="radio"/> PEN (720 x)	210-333/1000-079	100
<input type="radio"/> only grid spacing	210-333/1000-001	100

Marking Card; Self-Adhesive Marking Strips

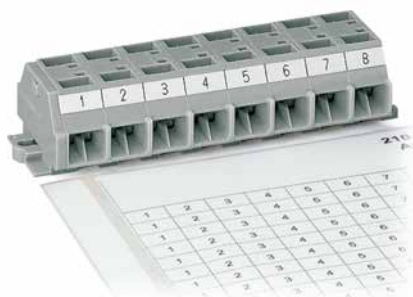

- Horizontal marking
- Strip length: 182 mm
- Strip height: 6 mm

Marking strip; as DIN A4 sheet; for 2-conductor terminal strips (262 Series)

Marking	Item No.	Pack. Unit
<input type="radio"/> 1 ... 20 (40 x)	210-333/700-020	100
<input type="radio"/> 21 ... 40 (40 x)	210-333/700-108	100
<input type="radio"/> 41 ... 60 (40 x)	210-333/700-109	100
<input type="radio"/> 1 ... 50 (20 x)	210-333/700-021	100
<input type="radio"/> L1 (1040 x)	210-333/700-074	100
<input type="radio"/> L2 (1040 x)	210-333/700-075	100
<input type="radio"/> L3 (1040 x)	210-333/700-076	100
<input type="radio"/> N (1040 x)	210-333/700-077	100
<input type="radio"/> PE (1040 x)	210-333/700-078	100
<input type="radio"/> PEN (1040 x)	210-333/700-079	100
<input type="radio"/> only grid spacing	210-333/700-001	100

Marking strip; for 4-conductor terminal strips (262 Series)

<input type="radio"/> 1 ... 12 (40 x)	210-333/1200-103	100
<input type="radio"/> 13 ... 24 (40 x)	210-333/1200-104	100
<input type="radio"/> 25 ... 36 (40 x)	210-333/1200-105	100
<input type="radio"/> 37 ... 48 (40 x)	210-333/1200-106	100
<input type="radio"/> 49 ... 60 (40 x)	210-333/1200-107	100
<input type="radio"/> 1 ... 24 (20 x)	210-333/1200-203	100
<input type="radio"/> L1 (600 x)	210-333/1200-074	100
<input type="radio"/> L2 (600 x)	210-333/1200-075	100
<input type="radio"/> L3 (600 x)	210-333/1200-076	100
<input type="radio"/> N (600 x)	210-333/1200-077	100
<input type="radio"/> PE (600 x)	210-333/1200-078	100
<input type="radio"/> PEN (600 x)	210-333/1200-079	100
<input type="radio"/> only grid spacing	210-333/1200-001	100

Group Marker Carrier and Marker Carrier TOPJOB® S



Group marker carrier; snap-on type for jumper slot; gray

	Item No.	Pack. Unit
○ 5 mm wide	2009-191	50 (25)
○ 10 mm wide	2009-192	50 (25)
○ 15 mm wide	2009-193	50 (25)

Marker carrier; for lateral marker slots; 5 mm wide

Color	Item No.	Pack. Unit
○ gray	2009-198	200 (25)

2009-193 Group Marker Carrier (equipped with marking strips) for all 2001 to 2016 Series TOPJOB® S Rail-Mount Terminal Blocks.
Do not use on an end plate!

Group marker carrier; snap-on type for jumper slot; gray

○ 10 mm wide	2009-196	50 (25)
--------------	----------	---------



Marker carrier; for jumper slots of double-deck, double-disconnect terminal blocks (2002 Series); 5 mm wide

Color	Item No.	Pack. Unit
○ gray	2002-160	50 (25)

Marker carrier; for jumper slots (2002 Series); 5 mm wide

Color	Item No.	Pack. Unit
○ gray	2002-161	100 (25)

Using marker carriers for marking strips (2002-161) in jumper slots.



Using marker carriers for marking strips (2009-198) in lateral marker slots.

Multilevel Marker Carrier TOPJOB® S



Double-deck marker carrier; pivoting		
Color	Item No.	Pack. Unit
○ gray	2000-121	50 (25)

Double-deck marker carrier; pivoting		
Color	Item No.	Pack. Unit
○ gray	2002-121	50 (25)

Triple-deck marker carrier; pivoting		
Color	Item No.	Pack. Unit
○ gray	2002-131	50 (25)



Double-deck terminal blocks:
A double-deck marker carrier (2000-121) can be retrofitted to double-deck terminal blocks without a marker carrier.

Group Marker Carriers (Adjustable in Height) and Laterally Movable Marking System

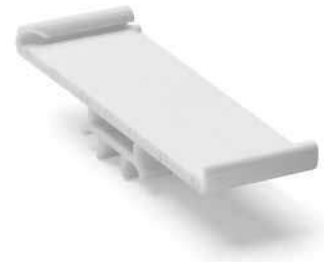

Group marker carrier; fits into jumper slot of rail-mount terminal blocks; for terminal block width 4 ... 6 mm; for up to 3 WMB markers or 8 branch markers; 15 mm wide

Color	Item No.	Pack. Unit
○ gray	209-140	50 (25)

Group marker carrier; snaps onto screwless 249-116 and 249-117 End Stops (center or side mounting); 10 mm wide

Color	Item No.	Pack. Unit
○ white	209-112	50 (25)

Group marker carrier; for WMB and Mini-WSB marker slots; 10 mm wide

Color	Item No.	Pack. Unit
○ white	209-145	100 (25)

Group marker carrier; fits into jumper slot of rail-mount terminal blocks; for up to 2 WMB markers or 5 branch markers; 10 mm wide

○ gray	209-141	50 (25)
--------	---------	---------

Group marker carrier; fits into jumper slot of rail-mount terminal blocks; for up to 1 WMB markers or 2 branch markers; 5 mm wide

○ gray	209-142	50 (25)
--------	---------	---------

Accessories; item-specific

Marker; from white cardboard; for self-marking; 100 markers/sheet

	white	209-113	1
---	-------	---------	---

Selbstklebeschild; zum Selbstbeschriften; 7 x 25 Stück/Bogen

	white	210-345	1
---	-------	---------	---

Schutzstreifen

	transparent	209-114	50
---	-------------	---------	----



Group marker carriers (209-141 and 209-112)



Group marking on N-busbar carrier used as an end stop



Group marker carrier (209-145)

Group Marker Carriers (Adjustable in Height) and Laterally Movable Marking System

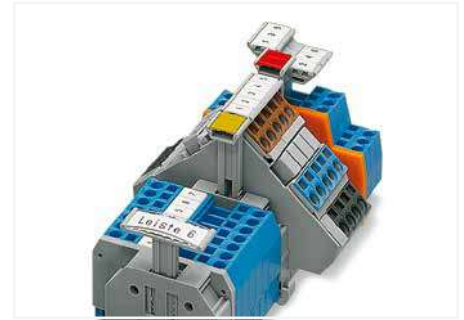

Height-adjustable group marker carrier; snaps onto end stops (249-116 and 249-117), adjustable in height from 43.5 to 59.5 mm; for 1 marker or self-adhesive marker and transparent protection cover; 10 mm wide

Color	Item No.	Pack. Unit
○ gray	249-119	50 (25)

Carrier-through element; height-adjustable; snaps onto end stops (249-116 and 249-117)

Color	Item No.	Pack. Unit
○ gray	709-118	50 (25)

Receptacles for:
 1 x marker
 2 x WMB Multi marker or
 1 x WFB continuous marking strip

Height-adjustable group marker carrier; snaps onto end stops (249-116 and 249-117), adjustable in height from 43.5 to 59.5 mm; for 2 WMB markers or 1 continuous strip; 10 mm wide

○ gray	249-118	100 (25)
--------	---------	----------

Carrier-end element; height-adjustable; snaps onto end stops (249-116 and 249-117)

○ gray	709-119	50 (25)
--------	---------	---------

Height-adjustable group marker carrier; snaps onto end stops (249-116 and 249-117), adjustable in height from 42.2 to 58.2 mm; with marking surface; 6 mm wide

○ white	249-120	50 (25)
---------	---------	---------

Height-adjustable group marker carrier; snaps onto end stops (249-116 and 249-117), adjustable in height from 45 to 61 mm; for 9 WMB markers or 1 marking strip TOPJOB® S; 12.2 mm wide

○ gray	2009-163	50 (25)
--------	----------	---------

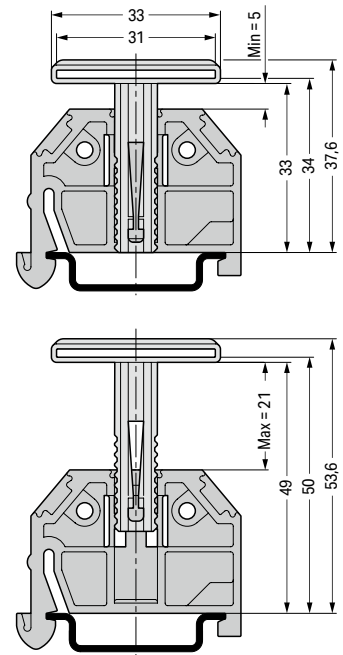

Dimensions in mm

Accessories; item-specific

Marking strip receptacle; folded; 1 m long; 16 mm wide; 1.7 mm thick

transparent	709-120	1
-------------	---------	---

Marking card; with 14 marking strips; DIN A4

	709-193	1
--	---------	---



Height adjustable group marker carrier (2009-163) for marking strips (2009-110)



This laterally movable marking system can be used as an additional group marker carrier or continuous marking strip carrier for terminal strips or single-deck rail-mount terminal blocks, e.g., for:

- DIN-35 rail-mount terminal strips (264 Series)
- Single-deck rail-mount terminal blocks (279 to 284 Series) with a maximum height of 49 mm (1.93 inch) from upper-edge of DIN-rail (please observe conductor radius)

Group Marker Carrier and Double Marker Carrier



Group marker carrier; angled; e.g., for transformer terminal blocks (282 Series)

Color	Item No.	Pack. Unit
○ gray	209-144	50 (25)

Double marker carrier; for center I/O module marking; for WSB and WMB marking systems; 4 mm wide

Color	Item No.	Pack. Unit
○ gray	209-128	200 (100)

Group marker carrier; straight; e.g., for 2- and 3-conductor terminal blocks (282 Series)

Color	Item No.	Pack. Unit
○ gray	209-143	50 (25)

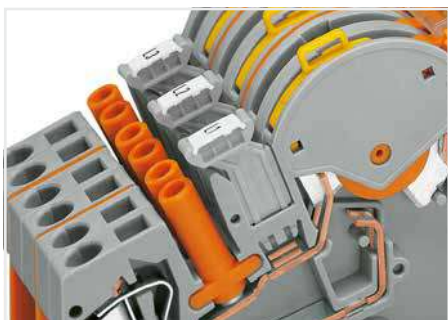

This group marker carrier (209-144) makes it possible to mark subgroups in confined places. They can be snapped into unused jumper contact slots of the terminal block housing. Labeling is performed via WMB Multi markers.



Snapping a WMB marker strip into the marker slot of the double marker carrier.

Group Marker Carrier (Pivoting)

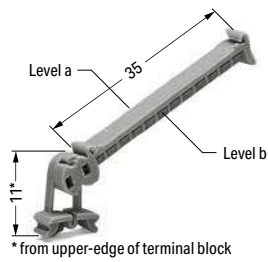

Pivoting group marker carrier

Color	Item No.	Pack. Unit
○ gray	249-105	50 (25)

Zubehör; artikelspezifisch

Marker; 4 x 30 markers/sheet

	white	209-183	1
---	-------	---------	---

Protective marker cover

	transparent	209-184	50
---	-------------	---------	----

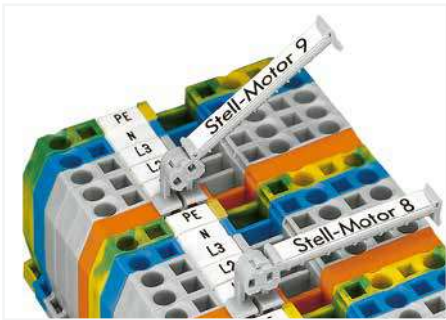

This pivoting group marker carrier has been developed for group marking of rail-mount terminal blocks and incorporates many customer requirements.

- Can be used in all multiprofile marker slots for rail-mount terminal blocks from 5 mm (0.197 inch) on or in spacer housings as shown above.
- Pivotal in seven different stable positions, providing the best visual angle in case of difficult mounting conditions

Thermal Transfer Printer Smart Printer



Open the printer.



Printer – open



Accessories for unwinding material



Insert the ink ribbon.



Prepare the marking material.



Insert and secure the appropriate roller into the printer.



Printer has several interfaces:
USB, ETHERNET, serial COM port



Fast, cost-effective and easy to use –
printing WMB Inline markers via Smart Printer

Thermal Transfer Printer and Cutter Smart Printer



Smart Printer; WMB Inline markers; Marking strips; Conductor markers and labels; Resolution: 300 dpi

Item No.	Pack. Unit
258-5000	1

Smart Printer

includes:

- Power supply and cable
- USB cable
- 1 x marking strip reel (2009-110)
- 1 x WMB Inline marker reel (2009-115)
- 2 x roller (258-5006 + 258-5007)
- 1 x reel holder
- 1 x ink ribbon (258-5005)

Technical Data

Printing method	Thermal transfer
Print head	Glass layer, spring-mounted
Print speed (max.)	127 mm/s (WAGO recommends 50.8 mm/s)
Print width (max.)	47 mm
Print length (max.)	762 mm
Print resolution	300 dpi (12 pixels/mm)
See-through/reflective sensor	Yes, centrally mounted
Operating display	Color TFT LCD with navigation button
Memory	8 MB Flash, 16 MB SDRAM
Interfaces	USB, RS-232, ETHERNET 10/100 Mbps, USB Host
Operating voltage	100 ... 240 VAC, 50 ... 60 Hz (automatic adjustment)
Dimensions (mm) W x H x D	135 x 175 x 245
Weight	2000 g (without printing material)
Operating temperature	5 ... 40 °C (41 ... 104 °F)
Storage temperature	-20 ... 50 °C (-4 ... 122 °F)
Safety approvals	CE (EMC)
Ink ribbon (see also Full Line Catalog, Volume 6, Marking)	External roll diameter: 40 mm; Internal core diameter: 12.7 mm (0.5 inch); Max. length: 110 m; Max. width: 58 mm



Cutter for Smart Printer; for marking strips only; not suitable for WMB Inline markers

Item No.	Pack. Unit
258-5030	1

Hardware requirements:

- Printer model: Smart Printer
- From manufacturing month/year: 0814 – August 2014
- Firmware version: 1.UW7i
- Printer driver: Version 7.4.2

Software requirements:

- Smart Script: Version 3.88.9.0 or higher
- WAGO printer settings: Version 2.4.0.0 or higher

Approved print material to be cut:

- Marking strips: 2009-110, 709-177, 709-178, 757-901/000-005
- Self-adhesive marking strips: 210-702, 210-870 ... -877
- Cable tie markers: 211-835 ... -836, 211-836/000-002
- Self-laminating labels: 211-855 ... -857
- Conductor markers for thread-on mounting: 211-861 ... -863
- Type labels: 210-801 ... -804, 210-812
- Continuous labels: 210-831 ... -834
- Label for circuit identification: 210-813

Dimensions of printing materials:

- Width (max.): 46 mm
- Thickness (max.): 250 µm

Technical Data

Width	60 mm
Height	107 mm
Depth	131 mm
Weight	1050 g

Control Cabinet Outlet and Switch Cabinet Drawer 709 Series

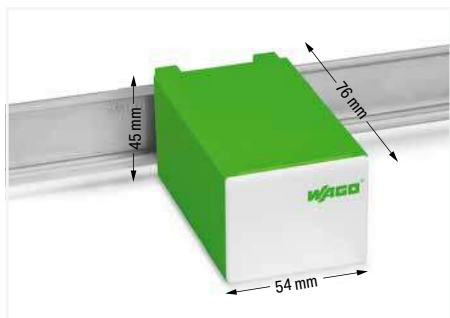

Technical Data

Ratings per	DIN VDE 0620-1
Voltage type	AC
Rated voltage	250 V
Rated surge voltage	2 kV
Rated current	16 A

Connection Data

Connection technology	Push-in CAGE CLAMP®
Actuation type	Type 2 (3.5 x 0.5) mm blade
Actuation direction	Operation parallel to conductor entry
Connectable conductor materials	Copper
Solid conductor	0.2 ... 2.5 mm / 24 ... 14 AWG
Stranded conductor	0.2 ... 2.5 mm / 24 ... 14 AWG
Fine-stranded conductor	0.2 ... 2.5 mm / 24 ... 14 AWG
Strip length	9 ... 10 mm / 0.35 ... 0.39 inch
Number of poles	3

Mechanical Data

Mounting type	DIN-35 rail
Protection type	IP20
Potential marking	L PE N

Material Data

Material group	I
Insulation material	Polyamide 66 (PA 66)
Flammability class per UL94	V0
Clamping spring material	Chrome nickel spring steel (CrNi)
Contact material	Copper alloy
Contact plating	Sn

Environmental Requirements

Continuous operating temperature from	-35 °C
Continuous operating temperature up to	85 °C

- ❶ The outlets are available in three colors to identify different circuits:
- 709-581 gray (standard)
 - 709-582 yellow (permanently energized)
 - 709-583 red (UPS)

Approvals and corresponding ratings, visit www.wago.com

Control Cabinet Outlet and Switch Cabinet Drawer 709 Series



Dimensions in mm

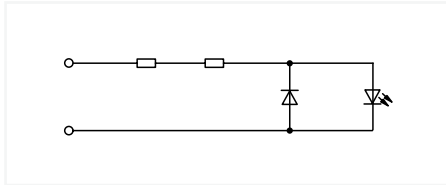
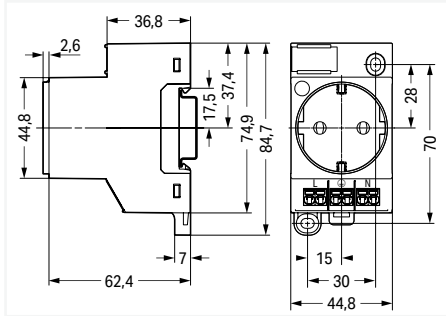

Control cabinet outlet; for DIN-35 rail and screw mounting; for plug Type F, CEE 7/4 (SCHUKO®); used in Germany, the Netherlands, Austria; with status LED; with Push-in CAGE CLAMP® double connection

Color	Item No.	Pack. Unit
○ light gray	709-581 1	1

Dimensions in mm

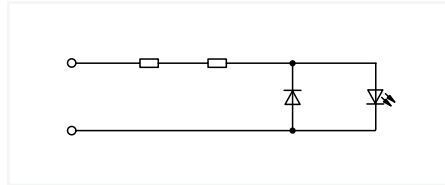
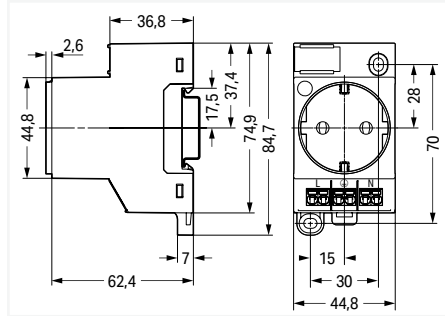

Control cabinet outlet; for DIN-35 rail and screw mounting; for plug Type F, CEE 7/4 (SCHUKO®); used in Germany, the Netherlands, Austria; with status LED; with Push-in CAGE CLAMP® double connection

Color	Item No.	Pack. Unit
● yellow	709-582 1	1

Dimensions in mm

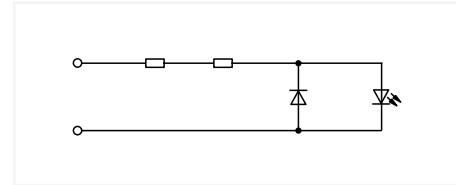
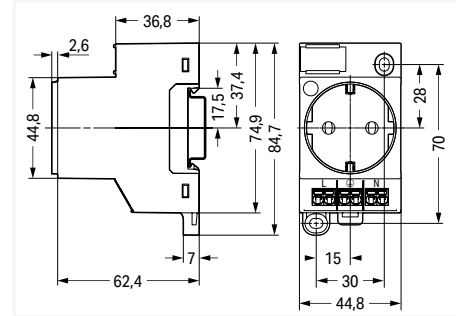

Control cabinet outlet; for DIN-35 rail and screw mounting; for plug Type F, CEE 7/4 (SCHUKO®); used in Germany, the Netherlands, Austria; with status LED; with Push-in CAGE CLAMP® double connection

Color	Item No.	Pack. Unit
● red	709-583 1	1



Dimensions in mm

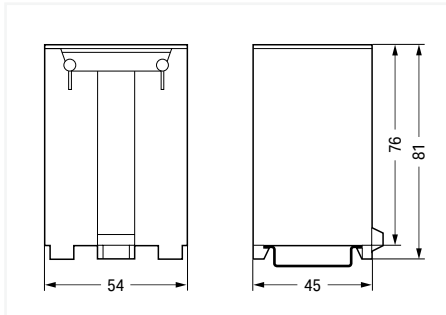

Switchgear cabinet drawer; DIN-35 rail-mount drawer

Item No.	Pack. Unit
709-591	1

DIN-Rail; Rail End Cap; Angled Support Bracket and Collective Jumper Carrier



Dimensions in mm

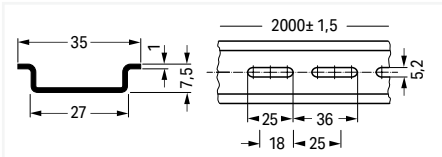

Steel DIN-rail; I_N 76 A (based on 1 m length); 35 x 7.5 mm; 1 mm thick; 2 m long; per EN 60715

	Item No.	Pack. Unit
unslotted	210-113	10 (1)

Hole width: 25 mm; Hole spacing: 36 mm

slotted	210-112	10 (1)
---------	---------	--------

Hole width: 18 mm; Hole spacing: 25 mm

slotted	210-115	1
---------	---------	---



Dimensions in mm

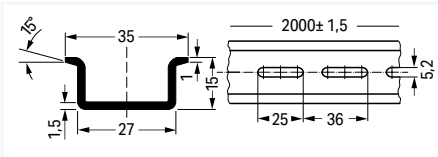

Steel DIN-rail; I_N 125 A (based on 1 m length); 35 x 15 mm; 1.5 mm thick; 2 m long; similar to EN 60715

	Item No.	Pack. Unit
unslotted	210-114	10 (1)
slotted	210-197	10 (1)



Dimensions in mm

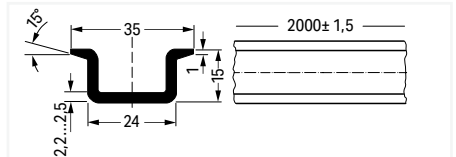

Steel DIN-rail; I_N 125 A (based on 1 m length); 35 x 15 mm; 2.3 mm thick; 2 m long; per EN 60715

	Item No.	Pack. Unit
unslotted	210-118	10 (1)



Dimensions in mm

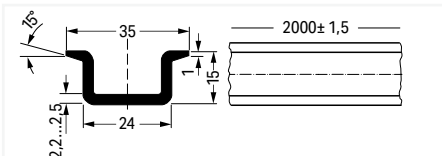

Copper DIN-rail; I_N 309 A (based on 1 m length); 35 x 15 mm; 2.3 mm thick; 2 m long; per EN 60715

	Item No.	Pack. Unit
unslotted	210-198	10 (1)



Dimensions in mm

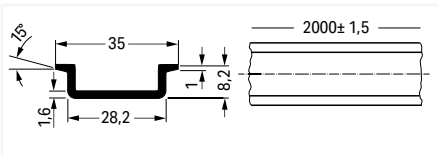

Aluminum DIN-rail; I_N 76 A (based on 1 m length); 35 x 8.2 mm; 1.6 mm thick; 2 m long; similar to EN 60715

	Item No.	Pack. Unit
unslotted	210-196	20 (1)



Rail end cap; for DIN-35 rail (7.5 mm high)

Color	Item No.	Pack. Unit
○ gray	209-109	50 (25)

14



Dimensions in mm

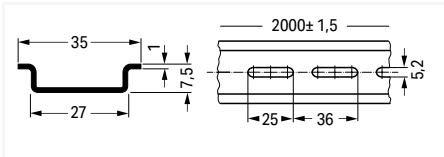

Steel DIN-rail; I_n 76 A (based on 1 m length); 35 x 7.5 mm; 1 mm thick; 2 m long; per EN 60715

	Item No.	Pack. Unit
unslotted	210-505	1
slotted	210-504	1



Dimensions in mm

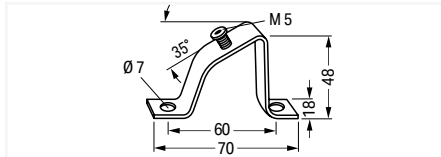

Angled support bracket; without screw

	Item No.	Pack. Unit
	210-148	10

Screw M5 x 8		
	210-149	100 (20)

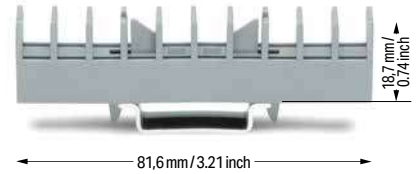

Collective jumper carrier; for DIN-35 rail; compatible with jumpers for transverse switching terminal block (282-811) and longitudinal switching disconnect terminal block (282-821)
The collective carrier can be snapped onto DIN-35 rails. It stores jumpers during maintenance.

Color	Item No.	Pack. Unit
○ gray	282-369	25



Dimensions in mm

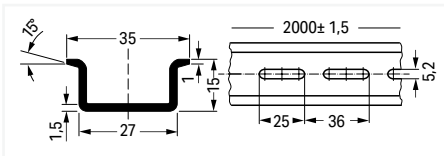

Steel DIN-rail; I_n 125 A (based on 1 m length); 35 x 15 mm; 1.5 mm thick; 2 m long; per EN 60715

	Item No.	Pack. Unit
unslotted	210-506	1
slotted	210-508	1



Dimensions in mm

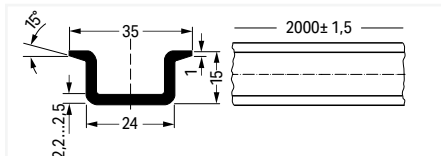

Carrier rail; plastic
Not suited for use with ground terminal blocks!

	Item No.	Pack. Unit
	210-509	10 (1)

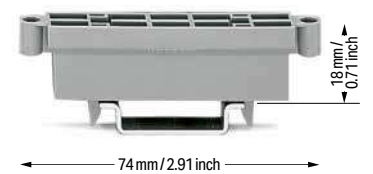

Collective carrier for adjacent jumpers; for DIN-35 rail; for adjacent jumpers (279 to 284 Series); for banana plugs (215 Series)
The collective carrier can be snapped onto DIN-35 rails. It stores adjacent jumpers and banana plugs during maintenance.

Color	Item No.	Pack. Unit
○ gray	209-100	50 (25)

Screwless End Stop; for DIN-35 Rail 249 Series

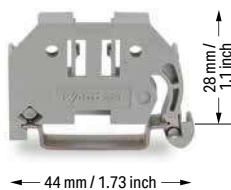

Screwless end stop; for DIN-35 rail; 6 mm wide

Color	Item No.	Pack. Unit
○ gray	249-116	100 (25)

Screwless end stop; for DIN-35 rail; 10 mm wide

○ gray	249-117	50 (25)
--------	---------	---------



Simply snap on – that's it!



Simply snap on – that's it!



Screwless end stop; for DIN-35 rail; 14 mm wide

Color	Item No.	Pack. Unit
○ gray	249-197	10



Simply snap on – that's it!

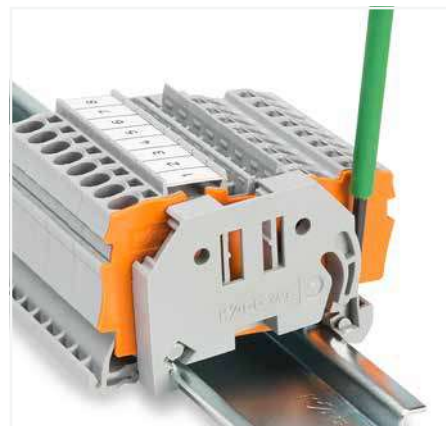

Removing an end stop from the DIN-rail.

Snap on – that's it! Assembling the WAGO Screwless End Stop is as simple and quick as snapping a rail-mount terminal block onto the rail.

Tool free!

A tool-free design allows rail-mount terminal blocks to be safely and economically secured against any movement on all DIN-35 rails per DIN EN 60715 (35 x 7.5 mm; 35 x 15 mm).

Screwless!

The "secret" to a perfect fit lies in the two small clamping plates which keep the end stop in position, even if the rails are mounted vertically.

Simply snap on – that's it!

In addition, costs are significantly reduced when using large numbers of end stops.

Additional benefit: Three marker slots for all WAGO Rail-Mount Terminal Block Marking Systems and one snap-in hole for WAGO's adjustable height group marker carriers offer individual marking options.

Mounting Foot



Mounting foot; for isolated DIN-35 rail mounting

Color	Item No.	Pack. Unit
<input type="radio"/> gray	209-106	25



Isolated mounting of a carrier rail in a distribution box for protection class II

Sealable, Transparent Covers for Rail-Mount Terminal Blocks

709 Series

Description and Installation

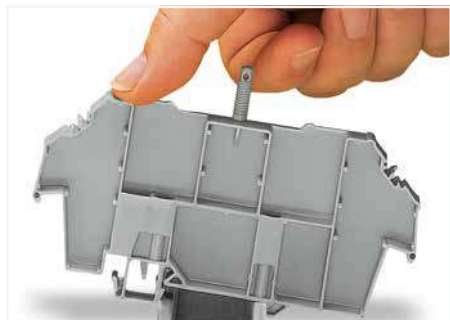

Snapping a cover carrier onto the DIN-rail.



Application example:
Cover (type 1) without safety warning



Application example:
Cover (type 1) with safety warning

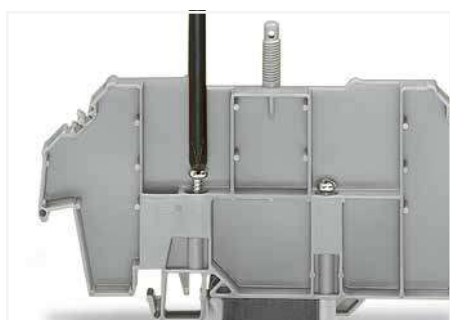

Tightening both securing screw (left) and mounting screw (right).



Application example:
Cover (type 2) with safety warning



Securing screw – prevents lifting off from the rail.
Mounting screw – prevents the cover carrier from being moved on the rail.



Removing a cover carrier from the DIN-rail.



Inserting a marking strip into the cover.



Cover with lead seals:
Using covers without lead seals,
the thread dome-head can be broken off.

Sealable, Transparent Cover; for Rail-Mount Terminal Blocks 709 Series



Cover; Type 1; for cover carrier (type 1); 1 m long		
Color	Item No.	Pack. Unit
transparent	709-153	10

Cover; Type 2; for cover carrier (type 2); 1 m long		
Color	Item No.	Pack. Unit
transparent	709-154	10

Accessories			
Marking card; with 6 marking strips; for group marking or safety instructions			
	plain	709-183	1

Spare mounting/securing screw; for cover			
		209-196	200 (25)

Spare knurled nut; for cover			
		210-549	100 (25)



Cover carrier; Type 1; incl. mounting/securing screws and knurled nut; for rail-mount terminal blocks (279 to 282, 880 Series); for "Mini" rail-mount terminal blocks (264 Series); for sensor/actuator terminal blocks (270 Series)

Color	Item No.	Pack. Unit
○ gray	709-167	10

Cover carrier; Type 2; incl. mounting/securing screws and knurled nut; for rail-mount terminal blocks (283 to 285 Series); for double- and triple-deck terminal blocks (279 to 281 Series); for TOPJOB® rail-mount terminal blocks (780 to 785 and 775 Series); for sensor/actuator terminal blocks (280 Series); for disconnect/test terminal blocks for transformer circuits (282 Series)

Color	Item No.	Pack. Unit
○ gray	709-168	10

Dimensions in mm

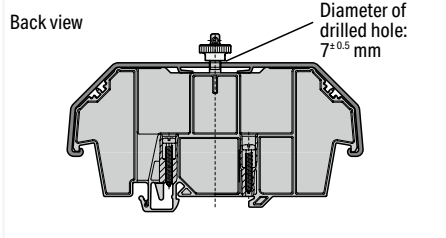
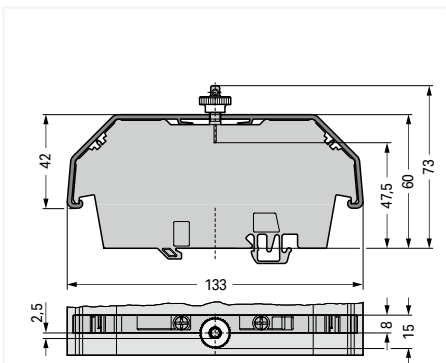

Dimensions in mm

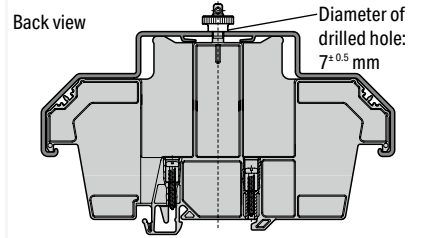
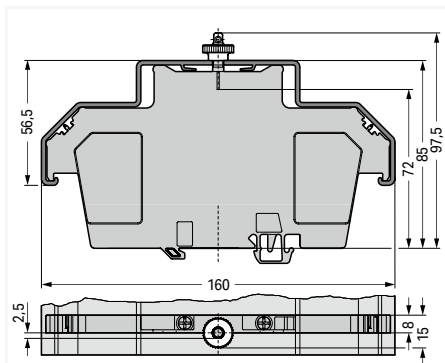



Sealable, Transparent Cover; for Rail-Mount Terminal Blocks 709 Series



Cover; Type 3; for cover carrier (type 3); 1 m long		
Color	Item No.	Pack. Unit
transparent	709-156	10

Accessories			
Marking card; with 6 marking strips; for group marking or safety instructions			
	plain	709-183	1

Marking strip; plain; 11 mm wide; 50 m reel			
	white	2009-110	1

Spare mounting/securing screw; for cover			
		209-196	200 (25)

Spare knurled nut; for cover			
		210-549	100 (25)



Cover carrier; Type 3; for rail-mount terminal blocks (2000 to 2016 Series, 2102 to 2116 Series, 2200 to 2216 Series); for transformer terminal blocks (2007 Series)		
Color	Item No.	Pack. Unit
○ gray	709-169	10

Dimensions in mm

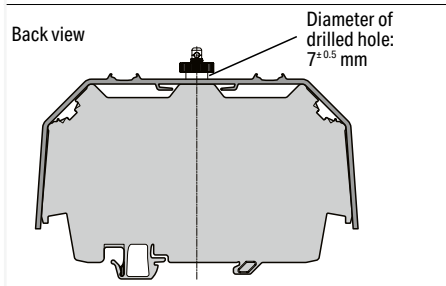
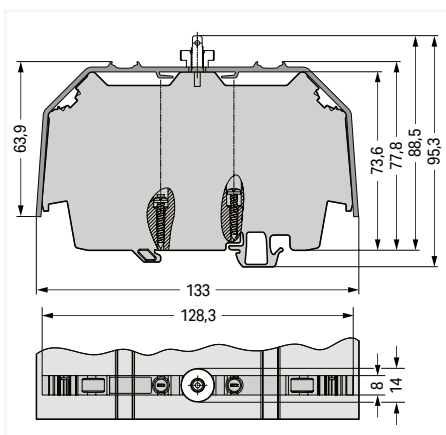

DIN-Rail and End Stop; for DIN-15 Rail



Dimensions in mm

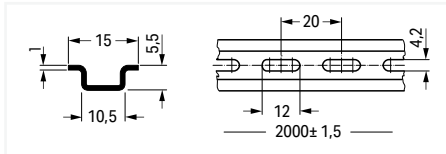

Steel DIN-rail; I_n 57 A (based on 1 m length); 15 x 5.5 mm; 1 mm thick; 2 m long; per EN 60715

	Item No.	Pack. Unit
slotted	210-111	10 (1)



Dimensions in mm

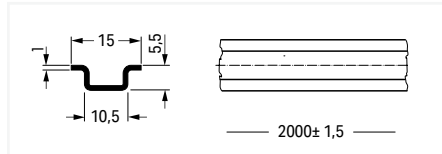

Aluminum DIN-rail; I_n 57 A (based on 1 m length); 15 x 5.5 mm; 1 mm thick; 2 m long; similar to EN 60715

	Item No.	Pack. Unit
unslotted	210-296	10 (1)



← 23,2 mm / 1.91 inch →

16 mm / 0.63 inch

Screwless end stop; for DIN-15 rail; 6 mm wide; for WMB markers

Color	Item No.	Pack. Unit
○ gray	249-101	25



Dimensions in mm

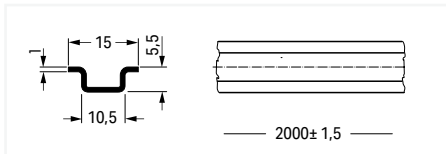

Steel DIN-rail; I_n 57 A (based on 1 m length); 15 x 5.5 mm; 1 mm thick; 2 m long; per EN 60715

	Item No.	Pack. Unit
unslotted	210-295	1

Operating Tool



Operating tool with a partially insulated shaft; Type 1, (2.5 x 0.4) mm blade

Item No.	Pack. Unit
210-719	50 (1)



Operating tool with a partially insulated shaft; Type 1; (2.5 x 0.4) mm blade; short

Item No.	Pack. Unit
210-647	50 (1)



Operating tool; Blades: 3.5 mm and 2.5 mm; for installation terminal blocks (TOPJOB® S)

Item No.	Pack. Unit
2009-309	50 (1)

Operating tool with a partially insulated shaft; Type 2, (3.5 x 0.5) mm blade

210-720	50 (1)
---------	--------

Operating tool with a partially insulated shaft; (2.5 x 0.4) mm blade; short; angled

210-648	50 (1)
---------	--------

Operating tool; Blades: 3.5 mm and 5.5 mm; for installation terminal blocks (TOPJOB® S)

2009-310	50 (1)
----------	--------

Operating tool with a partially insulated shaft; Type 3, (5.5 x 0.8) mm blade

210-721	25 (1)
---------	--------

Operating tool with a partially insulated shaft; (3.5 x 0.5) mm blade; short

210-657	50 (1)
---------	--------

Set of operating tools with a partially insulated shaft; Type 1, (2.5 x 0.4) mm blade; Type 2, (3.5 x 0.5) mm blade; Type 3, (5.5 x 0.8) mm blade

210-722	1
---------	---

Operating tool with a partially insulated shaft; (3.5 x 0.5) mm blade; short; angled

210-658	50 (1)
---------	--------

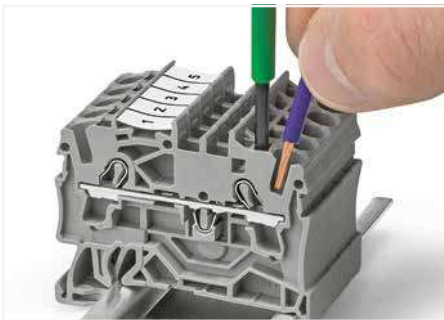

The blade of this operating tool with a partially insulated shaft is ideal for operating front-entry terminal blocks.

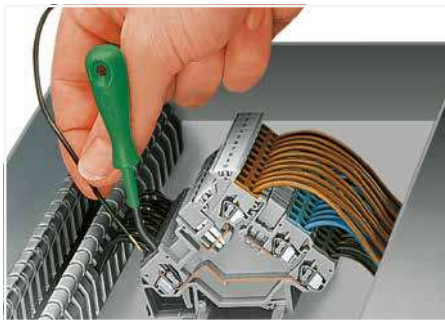

This operating tool with blade dimensions per DIN 5264 is ideal for front-entry sensor/actuator terminal blocks (280 Series).



Open the clamping unit using an operating tool.



Set of operating tools in a box (210-722)

Operating Tool



Operating tool; insulated; for 279 Series

	Item No.	Pack. Unit
1-way	209-129	100 (1)
2-way	279-432	100 (1)
3-way	279-433	100 (1)
10-way	279-440	30 (1)



Operating pliers; for side-entry rail-mount terminal blocks (281, 282, 283 and 284 Series)

	Item No.	Pack. Unit
	210-141	1



T-wrench with a partially insulated shaft

	Item No.	Pack. Unit
	285-172	1

Operating tool; insulated; for 264 Series (1- and 2-way only), 280, 281 Series (up to 3-way only)

	Item No.	Pack. Unit
1-way	209-130	100 (1)
2-way	280-432	100 (1)
3-way	280-433	100 (1)
4-way	280-434	40 (1)
5-way	280-435	40 (1)
6-way	280-436	30 (1)
7-way	280-437	30 (1)
8-way	280-438	30 (1)
9-way	280-439	30 (1)
10-way	280-440	30 (1)

Operating pliers; for side-entry rail-mount terminal blocks (279 and 280 Series)

	Item No.	Pack. Unit
	210-143	1

T-wrench with a partially insulated shaft and anti-rotation protection

	Item No.	Pack. Unit
	285-173	1

Operating tool; insulated; for 281 Series

	Item No.	Pack. Unit
5-way	281-440	40 (1)



Commoning front-entry disconnect terminal blocks via comb-style jumper bar using a 10-pole operating tool.

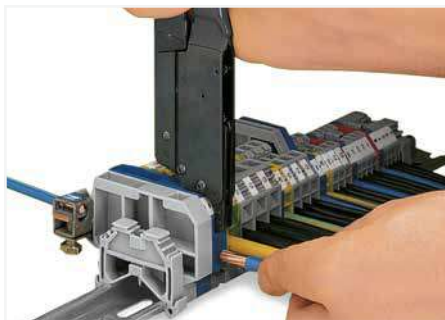

When operating the handles beyond the locked position, the ratchet allows the tool to open and be removed from the terminal block.
The operating pliers are placed into the upper operating slot of the rail-mount terminal block and the clamp is hooked into the lateral operating slot. The contact is fully opened by pressing the handles together until they engage. This will allow both hands to be used for wiring the terminal blocks.



T-wrench with a partially insulated shaft and anti-rotation protection (285-173)

Cable Stripper



Never use this tool on or near live electrical circuits!

Cable knife; for Ø 8 ... 28 mm / 0.31 ... 1.10 inch; with a unique, changeable cable bracket system; including cable bracket

Item No.	Pack. Unit
206-1403	1

Cable knife set; for Ø 4 ... 70 mm / 0.16 ... 2.75 inch; including all cable brackets in a Sortimo® Box

Item No.	Pack. Unit
206-1400	1



To replace the cable bracket, use the new bracket as an operating tool and pull it upwards.

Item-Specific Accessories

Cable bracket; for Ø 4 ... 16 mm / 0.16 ... 0.63 inch

	206-1411	1
--	----------	---

Cable bracket; for Ø 8 ... 28 mm / 0.31 ... 1.10 inch

	206-1412	1
--	----------	---

Cable bracket; for Ø 27 ... 35 mm / 1.06 ... 1.38 inch

	206-1413	1
--	----------	---

Cable bracket; for Ø 35 ... 50 mm / 1.38 ... 1.97 inch

	206-1414	1
--	----------	---

Cable bracket; for Ø 50 ... 70 mm / 1.97 ... 2.75 inch

	206-1415	1
--	----------	---

Accessories

Spare inside blade

	206-1418	1
--	----------	---

Spare hook blade

	206-1419	1
---	----------	---



The cutting depth of the hook blade can be adjusted with the slider.



The cutting depth of the inner knife can be adjusted with the screw.

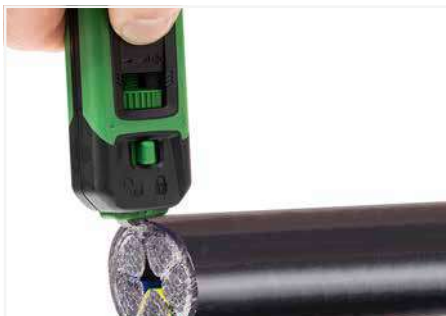

Strip large cross sections with the hook blade.



Release the fuse before using the hook blade.

Cable Stripper



In-socket cable stripper; for Ø 8 ... 13 mm / 5/16 ... 1/2 inch

Item No.	Pack. Unit
206-1441	1

Universal cable stripper; for Ø 8 ... 13 mm / 5/16 ... 1/2 inch

Item No.	Pack. Unit
206-1442	1

Data cable stripper; for Ø 4.5 ... 10 mm / 3/16 ... 3/8 inch

Item No.	Pack. Unit
206-1451	1



Product features:

- Extra long design and improved force transmission simplifies stripping in deep device connection sockets
- Special four-blade design for an even more precise round cut
- No cutting depth adjustment required
- TiN-coated blades, TÜV/GS tested
- Ø 8... 13 mm / 5/16 ... 1/2 inch
- Strips all standard round cables, including NYM 3 x 1.5 mm²/16 AWG ... 5 x 2.5 mm²/14 AWG



Sheath stripping: longitudinal cut

Product features:

- Secure grip achieved with soft padding for non-slip grips
- Technically improved functionality
- New locking mechanism prevents the unwanted opening of the tool
- Absolutely straightforward, quick and easy longitudinal cuts – with innovative internal cable duct
- Redesigned blade layout and intake to stop cable waste from jamming the tool
- Durable and ergonomically designed pocket clip
- Ø 8 ... 13 mm / 5/16 ... 1/2 inch



Product features:

- Strip outer insulation and foil sheathing with one tool
- Ideal for stripping PVC-insulated data cables with thin insulation (e.g., Cat. 5, Cat. 6, Cat. 7, twisted pair cable)
- TiN-coated blades
- Ø 4.5 ... 10 mm / 3/16 ... 3/8 inch



Stripping a cable sheath.



Built-in handy knife



Stripping a conductor insulation.

Cable Stripper



Never use this tool on or near live electrical circuits!

The stripping pliers for sensor cables have a blade geometry specially designed for sensor cables with a smaller cross section and a working range from Ø 3.2 mm / 0.13 inch (for stranded cables and round cables with Ø 3.2 mm ... 4.4 mm / 0.13 ... 0.17 inch).

The stripping pliers for control cables are designed for stronger cables from Ø 4.4 mm / 0.17 inch (for stranded cables and round cables with Ø 4.4 mm ... 7 mm / 0.17 ... 0.27 inch).

These stripping pliers quickly and safely strip cables for connecting, e.g., sensor/actuator distribution boxes, bus couplers and pluggable connectors.

- Suitable for:
- Halogen-free PUR sensor/actuator cables
 - Highly flexible TPE-U cables
 - Control cables
 - PUR cables
 - PUR/PVC cables
 - PVC cables
 - Multi-core cables
 - Shielded and unshielded cables

Stripping pliers; for sensor cables; for Ø 3.2 ... 4.4 mm / 0.13 ... 0.17 inch

Item No.	Pack. Unit
206-1481	1

Stripping pliers; for control cables; for Ø 4.4 ... 7 mm / 0.17 ... 0.27 inch

Item No.	Pack. Unit
206-1482	1

Item-Specific Accessories

Replacement blade set; for Ø 3.2 ... 4.4 mm / 0.13 ... 0.17 inch

206-1491	1
----------	---



Item-Specific Accessories

Replacement blade set; for Ø 4.4 ... 7 mm / 0.17 ... 0.27 inch

206-1492	1
----------	---



Wire Stripper



Wire stripper "Quickstrip Vario"; 0.03 ... 16 mm² / 34 ... 6 AWG; with wire cutter

Item No.	Pack. Unit
206-1125	1

Accessories

Blade set; Standard; 0.03 ... 16 mm² / 34 ... 6 AWG

206-1126 1



Blade set; V-blade; 0.14 ... 4 mm² / 24 ... 12 AWG

206-1127 1



Blade set; Oval blade; 10 ... 16 mm² / 8 ... 6 AWG

206-1128 1



Spare stripping stop

206-1129 1



Spare cut protector

206-1131 1



Spare clamping jaws

206-1132 1

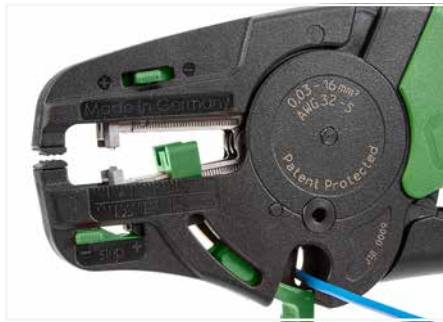

Cutting a conductor.



Partially stripping a conductor.

Wire Stripper:

- Automatically adjust to conductor size
- Stripping blades cause no damage to conductor strands
- Gripping pressure of jaws adjusts automatically to conductor insulation diameter
- Clamping jaws and stripping blades automatically open once the stripping process is completed – no splaying of the conductor strands
- Exact strip length may be set by sliding black setting stop
- Stripping blades can be replaced
- Self-sharpening, fully protected cutter (replaceable)
- Entire body made of glass-fiber-reinforced polyamide
- Cutting capacity of the wire cutter of fine-stranded conductors up to 16 mm² (6 AWG)

Crimping Tool



Crimping tool "Variocrimp 4"; for insulated and uninsulated ferrules; Crimping range: 0.25 ... 4 mm² (24 ... 12 AWG)

Item No.	Pack. Unit
206-1204	1

Crimping tool "Variocrimp 16"; for insulated and uninsulated ferrules; Crimping range: 6 mm² (10 AWG), 10 mm² (8 AWG) and 16 mm² (6 AWG)

Item No.	Pack. Unit
206-1216	1

Item-Specific Accessories

Spring clamp; large

	206-1205	1
--	----------	---

Spring clamp; small

	206-1206	1
---	----------	---

Item-Specific Accessories

Spring clamp; small

	206-1206	1
---	----------	---



Insert the ferruled conductor into the crimping station.



Squeeze handles until ratchet mechanism is released.

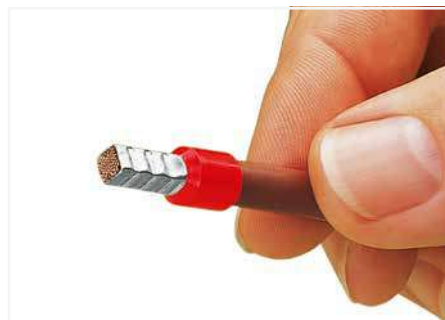

A perfect gas-tight crimp – both electrically and mechanically reliable



Only for "Variocrimp 16":
Adjust conductor cross section with crimping tool in open position.

What is a "gas-tight" connection?

In a gas-tight connection, the conductor and the ferrule are compressed, eliminating all spaces. Under normal atmospheric conditions, neither a liquid nor gaseous medium can penetrate the crimped connection. Oxidation between crimped single conductors is prevented, virtually eliminating the possibility of any increase in the crimped connection's resistance. In some exceptional cases, minute, isolated spaces may be present. However, these instances can be considered as closed off due to the twisted conductor.

Inadequate crimping can allow the conductor to be pulled out of the connection. Hollow spaces also remain, permitting oxidation formation and an increase in contact resistance.

Elevated resistance is detrimental for both signal transmission (signal flow is damped) and power transmission, resulting in power loss and contact heating (risk of fire). Crimping tools with built-in ratchets are recommended (e.g., WAGO Crimping Tools). These tools open automatically after the crimping operation is complete. Space-saving crimping from all four sides is ideal for spring clamp termination.

Ferruled conductor cross sections specified for WAGO products are based on this crimping method.

Insulated ferrule; for Rail-Mount Terminal Block TOPJOB® S

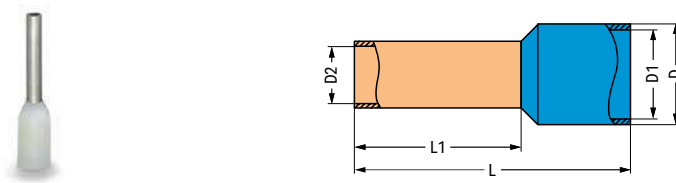

Ferrule; insulated; electro-tin-plated; electrolytic copper; gastight crimped; per DIN 46288 (Part 4/09.09)

Conductor Cross Section	Color	Strip Length	L	L 1	D	D 1	D 2	Item No.	Pack. Unit
0.5 mm ² / 20 AWG	○ white	12 mm / 0.47 inch	16	10	3.1	2.6	1	216-241	1000
0.75 mm ² / 18 AWG	○ gray	12 mm / 0.47 inch	16	10	3.3	2.8	1.2	216-242	1000
0.75 mm ² / 18 AWG	○ gray	14 mm / 0.55 inch	18	12	3.3	2.8	1.2	216-262	1000
1 mm ² / 18 AWG	● red	12 mm / 0.47 inch	16	10	3.5	3	1.4	216-243	1000
1 mm ² / 18 AWG	● red	14 mm / 0.55 inch	18	12	3.5	3	1.4	216-263	1000
1.5 mm ² / 16 AWG	● black	12 mm / 0.47 inch	16	10	4	3.5	1.7	216-244	1000
1.5 mm ² / 16 AWG	● black	14 mm / 0.55 inch	18	12	4	3.5	1.7	216-264	1000
1.5 mm ² / 16 AWG	● black	20 mm / 0.79 inch	24	18	4	3.5	1.7	216-284	500
2.5 mm ² / 14 AWG	● blue	12 mm / 0.47 inch	17	10	4.7	4.2	2.2	216-246	1000
2.5 mm ² / 14 AWG	● blue	14 mm / 0.55 inch	19	12	4.7	4.2	2.2	216-266	1000
2.5 mm ² / 14 AWG	● blue	20 mm / 0.79 inch	25	18	4.7	4.2	2.2	216-286	500
4 mm ² / 12 AWG	○ gray	14 mm / 0.55 inch	20	12	5.4	4.8	2.8	216-267	500
4 mm ² / 12 AWG	○ gray	20 mm / 0.79 inch	26	18	5.4	4.8	2.8	216-287	100
6 mm ² / 10 AWG	● yellow	14 mm / 0.55 inch	20	12	6.9	6.3	3.5	216-208	100
6 mm ² / 10 AWG	● yellow	20 mm / 0.79 inch	26	18	6.9	6.3	3.5	216-288	100
10 mm ² / 8 AWG	● red	20 mm / 0.79 inch	28	18	8.4	7.6	4.5	216-289	100
16 mm ² / 6 AWG	● blue	23 mm / 0.91 inch	28	18	9.6	8.8	5.8	216-210	100



Fine-stranded conductors with ferrules from at least two sizes below the rated cross section up to the rated cross section can also be simply pushed in – without tools.

Insulated and Uninsulated Ferrules; for Chassis-Mount Terminal Strip

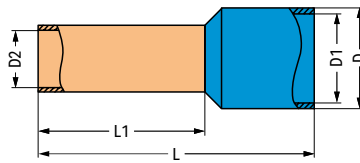

Ferrule; insulated; electro-tin-plated; electrolytic copper; gastight crimped; per DIN 46288 (Part 4/09.09)

Conductor Cross Section	Color	Strip Length	L	L 1	D	D 1	D 2	Item No.	Pack. Unit
0.5 mm ² / 20 AWG	○ white	12 mm / 0.47 inch	16	10	3.1	2.6	1	216-241	1000
0.75 mm ² / 18 AWG	○ gray	12 mm / 0.47 inch	16	10	3.3	2.8	1.2	216-242	1000
1 mm ² / 18 AWG	● red	12 mm / 0.47 inch	16	10	3.5	3	1.4	216-243	1000
1.5 mm ² / 16 AWG	● black	12 mm / 0.47 inch	16	10	4	3.5	1.7	216-244	1000

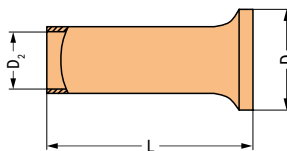

Ferrule; uninsulated; electro-tin-plated; electrolytic copper; gastight crimped; per DIN 46288 (Part 4/09.09)

Conductor Cross Section	Strip Length	L	D	D 2	Item No.	Pack. Unit
0.5 mm ² / 20 AWG	10 mm / 0.39 inch	10	2.1	1	216-141	5000 (1000)
0.75 mm ² / 18 AWG	10 mm / 0.39 inch	10	2.3	1.2	216-142	5000 (1000)
1 mm ² / 18 AWG	10 mm / 0.39 inch	10	2.5	1.4	216-143	5000 (1000)
1.5 mm ² / 16 AWG	10 mm / 0.39 inch	10	2.8	1.7	216-144	5000 (1000)

Insulated and Uninsulated Ferrules

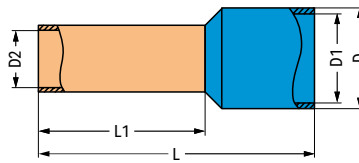

Ferrule; insulated; electro-tin-plated; electrolytic copper; gastight crimped; per DIN 46288 (Part 4/09.09)									
Conductor Cross Section	Color	Strip Length	L	L 1	D	D 1	D 2	Item No.	Pack. Unit
0.25 mm ² / 24 AWG	● yellow	7 mm / 0.28 inch	10	6	2.3	1.8	0.85	216-321	1000
0.25 mm ² / 24 AWG	● yellow	9 mm / 0.35 inch	12	8	2.3	1.8	0.85	216-301	1000
0.34 mm ² / 22 AWG	● light turquoise	7 mm / 0.28 inch	10	6	2.5	2	0.85	216-322	1000
0.34 mm ² / 22 AWG	● light turquoise	9 mm / 0.35 inch	12	8	2.5	2	0.85	216-302	1000
0.5 mm ² / 20 AWG	○ white	7 mm / 0.28 inch	12	6	3.1	2.6	1	216-221	1000
0.5 mm ² / 20 AWG	○ white	9 mm / 0.35 inch	14	8	3.1	2.6	1	216-201	1000
0.75 mm ² / 18 AWG	○ gray	8 mm / 0.31 inch	12	6	3.3	2.8	1.2	216-222	1000
0.75 mm ² / 18 AWG	○ gray	10 mm / 0.39 inch	14	8	3.3	2.8	1.2	216-202	1000
1 mm ² / 18 AWG	● red	8 mm / 0.31 inch	12	6	3.5	3	1.4	216-223	1000
1 mm ² / 18 AWG	● red	10 mm / 0.39 inch	14	8	3.5	3	1.4	216-203	1000
1.5 mm ² / 16 AWG	● black	8 mm / 0.31 inch	12	6	4	3.5	1.7	216-224	1000
1.5 mm ² / 16 AWG	● black	10 mm / 0.39 inch	14	8	4	3.5	1.7	216-204	1000
2.08 mm ² / 14 AWG	● yellow	10 mm / 0.39 inch	15	8	4.8	4.2	2.05	216-205	1000
2.5 mm ² / 14 AWG	● blue	10 mm / 0.39 inch	15	8	4.7	4.2	2.2	216-206	1000
4 mm ² / 12 AWG	○ gray	12 mm / 0.47 inch	18	10	5.4	4.8	2.8	216-207	500
6 mm ² / 10 AWG	● yellow	14 mm / 0.55 inch	20	12	6.9	6.3	3.5	216-208	100
10 mm ² / 8 AWG	● red	16 mm / 0.63 inch	22	12	8.4	7.6	4.6	216-209	100
16 mm ² / 6 AWG	● blue	23 mm / 0.91 inch	28	18	9.6	8.8	5.8	216-210	100

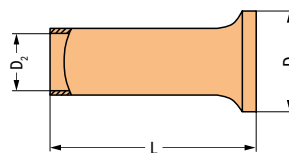

Ferrule; uninsulated; electro-tin-plated; electrolytic copper; gastight crimped; per DIN 46288 (Part 4/09.09)						
Conductor Cross Section	Strip Length	L	D	D 2	Item No.	Pack. Unit
0.25 mm ² / 24 AWG	5 mm / 0.2 inch	5	1.7	0.75	216-151	1000
0.25 mm ² / 24 AWG	7 mm / 0.28 inch	7	1.7	0.75	216-131	1000
0.34 mm ² / 22 AWG	5 mm / 0.2 inch	5	1.8	0.85	216-152	1000
0.34 mm ² / 22 AWG	7 mm / 0.28 inch	7	1.8	0.85	216-132	1000
0.5 mm ² / 20 AWG	6 mm / 0.24 inch	6	2.1	1	216-121	1000
0.5 mm ² / 20 AWG	8 mm / 0.31 inch	8	2.1	1	216-101	1000
0.75 mm ² / 18 AWG	6 mm / 0.24 inch	6	2.3	1.2	216-122	1000
0.75 mm ² / 18 AWG	8 mm / 0.31 inch	8	2.3	1.2	216-102	1000
1 mm ² / 18 AWG	6 mm / 0.24 inch	6	2.5	1.4	216-123	1000
1 mm ² / 18 AWG	8 mm / 0.31 inch	8	2.5	1.4	216-103	1000
1.5 mm ² / 16 AWG	6 mm / 0.24 inch	6	2.8	1.7	216-124	1000
1.5 mm ² / 16 AWG	8 mm / 0.31 inch	8	2.8	1.7	216-104	1000
2.5 mm ² / 14 AWG	10 mm / 0.39 inch	10	3.4	2.2	216-106	1000
4 mm ² / 12 AWG	10 mm / 0.39 inch	10	4	2.8	216-107	1000
6 mm ² / 10 AWG	12 mm / 0.47 inch	12	4.7	3.5	216-108	500
10 mm ² / 8 AWG	12 mm / 0.47 inch	12	5.8	4.5	216-109	500
16 mm ² / 6 AWG	15 mm / 0.59 inch	15	7.5	5.8	216-110	500

Crimping Tool



Crimping tool 25; for insulated and uninsulated ferrules; crimping range: 10 mm² (8 AWG), 16 mm² (6 AWG) and 25 mm² (4 AWG)

Item No.	Pack. Unit
206-1225	1

Crimping tool 50; for insulated and uninsulated ferrules; crimping range: 35 mm² (2 AWG) and 50 mm² (1/0 AWG)

Item No.	Pack. Unit
206-1250	1



Insert the ferruled conductor into the crimping station.



Squeeze handles until ratchet mechanism is released.

Application notes:

- Improved crimping for higher conductor retention
- Crimping can be performed from either side (for left- or right-handed users).
- Built-in ratchet mechanism ensures gas-tight crimp connection.
- Crimping tools open automatically after crimping operation is complete.
- Ergonomically designed handles.

What is a "gas-tight" connection?

In a gas-tight connection, the conductor and the ferrule are compressed, eliminating all spaces. Under normal atmospheric conditions, neither a liquid nor gaseous medium can penetrate the crimped connection.

Oxidation between crimped single conductors is prevented, virtually eliminating the possibility of any increase in the crimped connection's resistance. In some exceptional cases, minute, isolated spaces may be present. However, these instances can be considered as closed off due to the twisted conductor.

Inadequate crimping can allow the conductor to be pulled out of the connection. Hollow spaces also remain, permitting oxidation formation and an increase in contact resistance.

Elevated resistance is detrimental for both signal transmission (signal flow is damped) and power transmission, resulting in power loss and contact heating (risk of fire). Crimping tools with built-in ratchets are recommended (e.g., WAGO Crimping Tools). These tools open automatically after the crimping operation is complete. Space-saving crimping from all four sides is ideal for spring clamp termination.

Ferruled conductor cross sections specified for WAGO products are based on this crimping method.

Uninsulated Ferrule

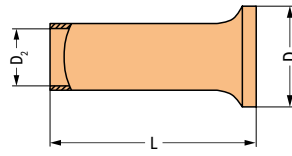

Ferrule; uninsulated; electro-tin-plated; electrolytic copper; gastight crimped; per DIN 46288 (Part 4/09.09)

Conductor Cross Section	Strip Length	L	D	D 2	Item No.	Pack. Unit
25 mm ² / 4 AWG	25 mm / 0.98 inch	25	9.5	7.3	216-413	50
35 mm ² / 2 AWG	25 mm / 0.98 inch	25	11	8.3	216-414	50
35 mm ² / 2 AWG	30 mm / 1.18 inch	30	11	8.3	216-424	50
50 mm ² / 1/0 AWG	30 mm / 1.18 inch	30	13	10.3	216-425	50
50 mm ² / 1/0 AWG	35 mm / 1.38 inch	35	13	10.3	216-435	50

Cable Cutter



Cable cutter; for copper and aluminum cables up to 35 mm² (2 AWG)

Item No.	Pack. Unit
206-118	10 (1)



Cutting a cable.

Test and Measurement Devices

206 Series



Testboy; with integrated flashlight, non-contact voltage tester		
Item No.	Pack. Unit	
206-804	6 (1)	

Spare test probes; 4 mm Ø (2 pieces)		
Item No.	Pack. Unit	
206-808	1	

WAGO Test Probes; 2 mm Ø; 1000 V; CAT IV; 10 A		
Item No.	Pack. Unit	
206-912	1	



A device that will reliably detect AC voltage in cables, sockets, fuses, switches, outlets and other installations. Testboy can detect the following:

- Live conductors
- Cable breaks
- Blown fuses (in cartridges or holders)
- Defective switches
- Defective lamps in strings of lights

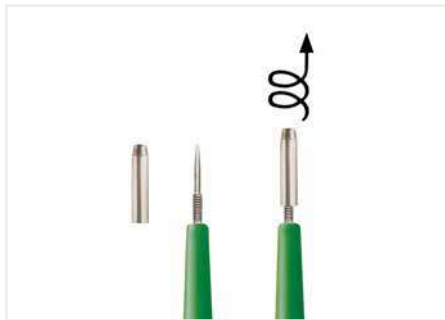

Profi-LED+:

- Improved socket contact via 4 mm Ø test probes
- Removable test probes for small test ports (suitable for all WAGO Terminal Blocks)

Banana Plug (Only for Safety Extra-Low Voltage) 215 Series

Technical Data	
0.08 ... 2.5 mm ²	28 ... 14 AWG
max. 42 V	
Test current: 20 A	
Measuring range category: CAT I	
9 ... 11 mm / 0.35 ... 0.43 inch	



Conductor termination: Press button fully, insert stripped conductor into square entry and release.



Testing via banana plug. Picture shows a test plug adapter (209-170).

Banana plug; for 4 mm socket diameter; color mixed; 10 x orange, white, black, blue, yellow

Item No.	Pack. Unit
215-111	50

Banana plug; single

Banana plug; for 4 mm socket diameter



orange	215-211	50
--------	---------	----

Banana plug; for 4 mm socket diameter



red	215-212	50
-----	---------	----

Banana plug; for 4 mm socket diameter



black	215-311	50
-------	---------	----

Banana plug; for 4 mm socket diameter



green	215-411	50
-------	---------	----

Banana plug; for 4 mm socket diameter



yellow	215-511	50
--------	---------	----

Banana plug; for 4 mm socket diameter



white	215-611	50
-------	---------	----

Banana plug; for 4 mm socket diameter



blue	215-711	50
------	---------	----

Banana plug; for 4 mm socket diameter



gray	215-811	50
------	---------	----

Banana plug; for 4 mm socket diameter



green-yellow	215-911	50
--------------	---------	----

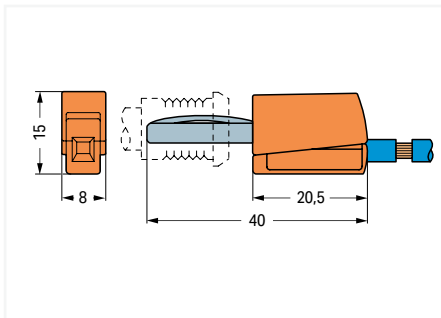

Dimensions in mm

Test Plug 210 Series



Test plug; with 500 mm cable; 2 mm Ø; max. 42 V

Color	Item No.	Pack. Unit
● red	210-136	50 (1)

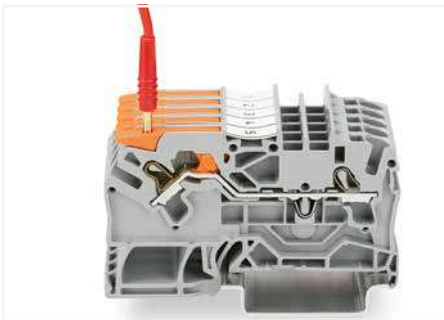

Testing with a 2 mm Ø test plug (max. 42 V).

"Alu-Plus" Contact Paste Terminating Aluminum Conductors



Syringe; contains 20 ml "Alu-Plus" Contact Paste

Item No.	Pack. Unit
249-130	20 (5)



WAGO Lighting Connectors

Push nozzle of the "Alu-Plus" syringe first into the circular entry and then into the square conductor entry hole of the WAGO Lighting Connector.



Press plunger down until the "Alu-Plus" has filled both entry holes.

Note: Not suitable for higher temperature applications!

Terminating Aluminum Conductors

WAGO spring clamp terminal blocks are suitable for solid aluminum conductors ① up to 4 mm²/12 AWG if WAGO "Alu-Plus" Contact Paste is used for termination.

"Alu-Plus" Contact Paste Advantages:

- Automatically destroys the oxide film during clamping.
- Prevents fresh oxidation at the clamping point.
- Prevents electrolytic corrosion between aluminum and copper conductors (in the same terminal block).
- Provides long-term protection against corrosion.



WAGO Rail-Mount Terminal Blocks (up to 4 mm²/12 AWG)

For each conductor entry: Insert nozzle of the "Alu-Plus" syringe in every open conductor entry hole (one after the other).



Press plunger down until "Alu-Plus" has filled all conductor entry holes.

For spring clamp connections with PUSH WIRE® connection technology, WAGO recommends that the aluminum conductor first be cleaned and then immediately inserted into the clamping unit filled with "Alu-Plus" contact paste

Using terminal blocks with CAGE CLAMP® Spring Pressure Connection Technology, aluminum conductors must first be cleaned with a blade and then immediately be inserted into the clamping units filled with "Alu-Plus" Contact Paste.

It is also possible to apply WAGO "Alu-Plus" additionally on the whole surface of the aluminum conductor before termination.

Please note that the nominal currents must be adapted to the reduced conductivity of the aluminum conductors:

2.5 mm² (14 AWG) = 16 A
4 mm² (12 AWG) = 22 A







WAGO "Alu-Plus" in the syringe offers a higher degree of reliability and cleanliness when terminating solid aluminum conductors. Filling is quickly performed on selected WAGO connectors and terminal blocks (see pictures).

① Aluminum conductors per IEC 61545 standard, Class B, "Alloy 1370" with 90 ... 180 N/mm² tensile strength and 1 ... 4% elongation
Standard values: 90 ... 180 MPa tensile strength, 1 ... 4% elongation (per EN 615.4.1)

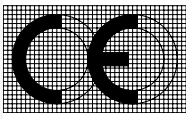

Technical Section

Technical Section

	Page
	728
Technical information CE Marking and EC Directives	728
	730
Tests and testing procedures Mechanical, Electrical, Material and Environmental Tests	730
	732
UL Specifications – Underwriters Laboratories, USA Tests and Testing Procedures per UL Standards	732
	752
“Alu-Plus” Contact Paste Terminating aluminum conductors	752
	755
Material Specifications Insulation Materials, Contact Plating, Contact Materials and Clamping Spring Material	755
	756
Technical Information on Electrical Equipment Used in Hazardous Areas Ⓢ	756
	761
All terminal blocks used in hazardous areas “Ex e II” have their item numbers marked with the Ex symbol.	761
	774
All terminal blocks used in intrinsically safe current circuits “Ex i” have their item numbers marked with a blue circle.	774
Operating WAGO Connection Technologies	772
	772
International Certification Organizations – Overview	772
	774
Electrical Engineering Laboratory Product Safety for Our Customers	774
	776
WAGO Seminars Learn Today – Benefit Tomorrow Benefit from First-Hand Knowledge and Expertise – Training Straight from the Source!	776

Operating WAGO Connection Technologies

Please follow the applicable product-specific termination instructions.

PUSH-IN CAGE CLAMP®



Push-in CAGE CLAMP® terminates the following copper conductors: solid



stranded



fine-stranded, also with tinned single strands



fine-stranded, tip-bonded



fine-stranded, with ferrule (gastight crimped)



fine-stranded, with pin terminal (gastight crimped)

The universal connection with an additional advantage:

Push-in connection

Terminate solid and stranded (Class B 7 strands or less), as well as ferruled conductors, by simply pushing them in – no tools required.

Termination for all conductor types:

- Open clamping unit.
- Insert the conductor.
- Release clamp – done!

CAGE CLAMP®



CAGE CLAMP® terminates the following copper conductors: solid



stranded



fine-stranded, also with tinned single strands



fine-stranded, tip-bonded



fine-stranded, with ferrule (gastight crimped)



fine-stranded, with pin terminal (gastight crimped)

The universal connection for solid, stranded and fine-stranded conductors

Termination:

- Open clamping unit.
- Insert the conductor.
- Release clamp – done!

Operating WAGO Connection Technologies

Please follow the applicable product-specific termination instructions.

POWER CAGE CLAMP®



POWER CAGE CLAMP terminates the following copper conductors:
solid



stranded



fine-stranded,
also with tinned
single strands



fine-stranded,
with ferrule
(gastight crimped)

The universal connection for conductors larger than 35 mm² (2 AWG)

Termination:

- Open clamp by turning a T-wrench counter-clockwise.
- Press the integrated latch to open clamping unit for hands-free wiring.
- Insert the conductor.
- A small counter-clockwise rotation closes the clamp, securing conductor.

PUSH WIRE®

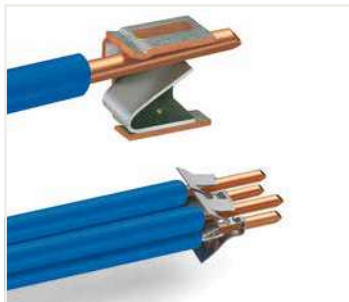

PUSH WIRE® terminates the following copper conductors:
solid

PUSH WIRE® connection for solid and stranded conductors (depending on the model used)

Termination:

Tool-free, twist-free terminations for solid and rigid stranded conductors – simply push into the unit.

CE Marking and EC Directives

CE Conformity Marking

The CE conformity marking consists of the characters "CE" with the following script:

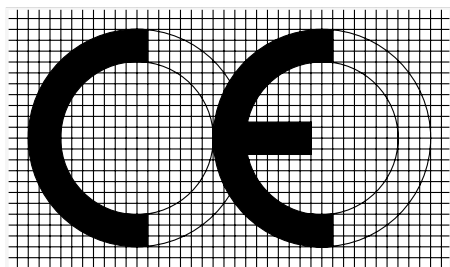

Communauté Européenne
(European Community)

WAGO GmbH & Co. KG products are developed, tested and marked in accordance with legally valid international standards and laws.

The CE mark is applied to products intended for the European domestic market; with it, manufacturers declare that the marked electrical equipment conforms with the applicable requirements set out in the Community harmonization legislation (EU Directives), which allows such equipment to carry this mark.

The original intention of this mark was to support the authorities in the EU member states in their market supervision, with the mark acting as a symbol of free movement of products within the EU. According to EC Directive 765/2008, a product can only be given the CE mark if the product requirements are defined in at least one appropriate EU directive. Examples of such directives are the Low Voltage Directive, the EMC Directive, the ATEX Directive, the Building Products Directive and the Machinery Directive. If more than one directive applies to a product, the product must comply with all applicable directives.

Only the basic requirements for achieving the defined aim of the directive are laid out in each respective directive. The individual technical details are specified according to the New Approach using lists with cross references to applicable standards (so-called harmonized standards).

1. Low Voltage Directive (LVD)

The safety of electrical equipment is guaranteed by the Low Voltage Directive (LVD). The LVD covers all electrical equipment operating with a voltage between 50 VAC and 1000 VAC and between 75 VDC and 1500 VDC.

Products falling within the scope of the Low Voltage Directive that are designed in such a way that they can be used in other electrical devices, and whose safety, for the most part, is dependant on how these components were built into the end product and what features the end product has, are defined as basic components in accordance with the Low Voltage Directive.

The LVD doesn't apply to basic components.

The RoHS Directive also applies to electrical equipment covered by the Low Voltage Directive. This

directive regulates the use of hazardous substances in electrical devices and components, with the aim of reducing the quantity of problematic components in electrical waste. Details about the materials used by WAGO are available in our catalogs, on our product packaging and on our Web page.

2. EMC Directive

The EMC Directive stipulates that a product must meet the limits on radiated electromagnetic disturbance and also requires that a product must be immune to electromagnetic interference.

Electromagnetic passive components or components with no direct function, such as terminal blocks, resistors, diodes, capacitors, switching relays or cables (in the form of passive printed circuit boards) are not considered as apparatus within the meaning of the EMC Directive.

3. ATEX Directive on Explosion Protection

The ATEX Directive defines the rules for products (devices and protective systems) intended for use in hazardous locations. A number of products from WAGO are designed for use in hazardous areas.

Based on potential hazards, the ATEX Directive makes a distinction between three different equipment groups, of which Group II and III are subdivided into further zones. Suitability of WAGO products for the different groups and zones is outlined in the specific product documents (catalogs, Internet site, data sheets and product inserts).

These may be either devices that can be used as equipment in these types of areas, or components that are required for safe operation, but which do not fulfill a dedicated function. Such components include rail-mount terminal blocks for use in hazardous areas.

Products in both groups must comply with the ATEX Directive.

4. Radio Communications Directive

The Radio Communications Directive applies to all devices that properly transmit or receive radio waves for wireless communications and/or radio orientation. The basic safety requirements apply to the protection of health for humans and animals and to electrical safety in line with the Low Voltage Directive, but without the application of the voltage limit. In addition, the EMC protection goals of the EMC Directive must also be fulfilled and efficient use of radio frequencies ensured. WAGO products covered by the Radio Communications Directive indicate, in compliance with applicable laws, only the Radio Communication Directive in their EU Declaration of Conformity, as fulfillment of the Low Voltage Directive and of the EMC Directive is implicit in this declaration.

5. Construction Products Regulation

The Construction Products Regulation demands that structures be designed and constructed such that the safety of humans, property and animals is not endangered and that all applicable environmental protection requirements be considered. Here, building products are defined as products or

construction sets which are produced to be built permanently into structures and which make a significant contribution to fulfilling the basic requirements for the structure.

In the unanimous opinion expressed by the German electrical industry, including WAGO GmbH & Co. KG, products used in general installation technology are not included among these types of building products and are therefore not covered by this directive.

6. Machinery Directive

The Machinery Directive applies to machines (complete or incomplete) which perform their functions by means other than direct human or animal work, or safety components for these types of machines.

Therefore, this directive usually does not apply to WAGO products.

The manufacturers of machines or systems are required by this directive to use safe products and components in their machines and systems. Directive-compliant production and safe operation is facilitated by the use of WAGO products, with their standard-compliant, up-to-date design.

Significance of CE Mark for WAGO Products

One, several or none of the EU Directives may apply to the various WAGO products. If none of the directives apply, the CE marking will not be affixed to the product, in line with applicable laws. Furthermore, a declaration of conformity must not be issued. All other products are provided with the CE mark – either directly on the product, on its packaging or in the documents included with the product – and a declaration of conformity is issued, or made accessible to the customer.

The data sheets of the technically sound products that, according to the regulations, are not CE marked will refer to the standards used in the development and type and manufacturing testing wherever possible.

IEC/EN specifications

The following standards apply to the design and application of the terminal blocks and connectors contained in this catalog:

IEC 60364-1 HD 60364-1 VDE 0100-100 / Erection of power installations with nominal voltages up to 1000 V – Part 1: Fundamental principles, assessment of general characteristics, definitions	EN 50628 VDE 0118-10 / Installation of electrical equipment in mines	IEC 60999-2 EN 60999-2 VDE 0609-101 /– Part 2: General requirements and particular requirements for clamping units for conductors from 35 mm ² up to 300 mm ² (included)
IEC 60364-7-710 HD 60364-7-710 VDE 0100-710 /– Part 7-718: Requirements for special installations or locations – Medical areas	IEC 60038 EN 60038 VDE 0175-1 / IEC CENELEC standard voltages	IEC 60998-1 EN 60998-1 VDE 0613-1 / Connecting devices for low-voltage circuits for household and similar purposes – Part 1: General requirements
IEC 60364-7-718 HC 60364-7-718 VDE 0100-718 /– Part 7-718: Requirements for special installations or locations – Communal facilities and workplaces	VDE 0298-4 / Use of cables and insulated conductors in power installations – Part 4: Recommended values for current carrying capacities of cables for fixed installation and for flexible cables	IEC 60998-2-1 EN 60998-2-1 VDE 0613-2-1 /– Part 2-1: Particular requirements for connecting devices as separate entities with screw-type clamping units
IEC 60664-1 EN 60664-1 VDE 0110-1 / Insulation coordination for equipment within low-voltage systems – Part 1: Principles, requirements and tests	IEC 60112 EN 60112 VDE 0303-11 / Method for determining the comparative and the proof tracking indices of solid insulation materials	IEC 60998-2-2 EN 60998-2-2 VDE 0613-2-2 /– Part 2-2: Particular requirements for connecting devices as separate entities with screwless-type clamping units
EN 50110-1 VDE 0105-1 / Operation of electrical installations – Part 1: General requirements	IEC 60529 EN 60529 VDE 0470-1 / Degrees of protection provided by enclosures (IP Code) – Testing equipment and testing method	IEC 60998-2-3 EN 60998-2-3 VDE 0613-2-3 /– Part 2-3: Particular requirements for connecting devices as separate entities with insulation-piercing clamping units
IEC 60204-1 EN 60204-1 VDE 0113-1 / Safety of machinery – Electrical equipment of machines – Part 1: General requirements	IEC 61439-1 EN 61439-1 VDE 0660-600-1 / Low-voltage switchgear and control-gear assemblies – Part 1: General rules	IEC 60947-1 EN 60947-1 VDE 0660-100 / Low-voltage switchgear and controlgear – Part 1: General rules
IEC 61140 EN 61140 VDE 0140-1 / Protection against electric shock – Common aspects for installation and equipment	IEC 61439-3 EN 61439-3 VDE 0660-600-3 /– Low-voltage switchgear and control-gear assemblies – Part 3: Distribution boards intended to be operated by ordinary persons (DBO)	IEC 60947-7-1 EN 60947-7-1 VDE 0611-1 /– Part 7-1: Ancillary equipment – Terminal blocks for copper conductors
IEC 60079-0 EN 60079-0 VDE 0170-1 / Hazardous areas – Part 0: Equipment – General requirements	IEC 61643-11 EN 61643-11 VDE 0675-6-11 / Low-voltage surge protective devices – Part 11: Surge protective devices connected to low-voltage power systems – Requirements and test methods	IEC 60947-7-2 EN 60947-7-2 VDE 0611-3 /– Part 7-2: Ancillary equipment – Ground conductor terminal blocks for copper conductors
IEC 60079-7 EN 60079-7 VDE 0170-6 / Explosive atmospheres – Part 7: Equipment protection by increased safety "e"	IEC 60335-1 EN 60335-1 VDE 0700-1 / Safety of household and similar electrical appliances – Part 1: General requirements	IEC 60947-7-3 EN 60947-7-3 VDE 0611-6 /– Part 7-3: Ancillary equipment – Safety requirements for fuse terminal blocks
IEC 60079-11 EN 60079-11 VDE 0170-7 / Hazardous areas – Part 11: Equipment protection by intrinsic safety "i"	IEC 60598-1 EN 60598-1 VDE 0711-1 / Lighting fixtures – Part 1: General requirements and tests	VDE 0611-4 / Rail-mount terminal blocks for connection of copper conductors; – Multi-level distribution rail-mount terminal blocks up to 6 mm ²
IEC 60079-14 EN 60079-14 VDE 0165-1 / Hazardous areas – Part 14: Electrical installations design, selection and erection	IEC 60715 EN 60715 /– Standardized mounting on rails for mechanical support of electrical devices in switchgear and control-gear installations	IEC 61984 EN 61984 VDE 0627 / Connectors – Safety requirements and tests
IEC 60079-15 EN 60079-15 VDE 0170-16 / Explosive atmospheres – Part 15: Equipment protection by type of protection "n"	IEC 60999-1 EN 60999-1 VDE 0609-1 / Connecting devices – Electrical copper conductors – Safety requirements for screw-type and screwless-type clamping units – Part 1: General requirements and particular requirements for clamping units for conductors from 0.2 mm ² up to 35 mm ²	

Tests and Testing Procedures per IEC/EN Standards

Products such as connecting devices, rail-mount terminal blocks and connectors, etc., have their own product-specific test specifications. The following sections describe the most important tests and are limited to a description of the test procedures and an explanation of the test purpose. The data shown (e.g., voltages, temperatures, forces) only serve as illustration and may differ depending on the test.

Mechanical Tests

All WAGO products meet requirements for the following mechanical tests:

• Termination Requirements

Conductor Termination

Two WAGO connection systems are proven in the field of Spring Pressure Connection Technology:

The **PUSH WIRE® connection** for applications requiring solid conductors (e.g., for lighting and building wiring, telecommunications, house communication or alarm systems).

Conductor range:

0.2 ... 4 mm² / 24 ... 12 AWG

The **universal CAGE CLAMP® spring pressure connection system** for solid, stranded and fine-stranded conductors, designed for a variety of industrial, electrical and electronic applications (e.g., fine-stranded conductors in the elevator industry, in power stations, in the chemical and automotive industry, and aboard ships).

Conductor range:

0.08 ... 35 mm² (28 ... 2 AWG)

The **Push-in CAGE CLAMP® connection** takes universal CAGE CLAMP® connections further by allowing the termination of 0.2 ... 16 mm² (24 ... 6 AWG) solid, stranded and fine-stranded conductors (25 mm²/4 AWG only "f-st") and offering all the benefits and safety of the original CAGE CLAMP®. Furthermore, the Push-in CAGE CLAMP® connection technology allows solid, stranded and fine-stranded conductors with ferrules from 0.5 to 16 mm² (20 ... 6 AWG) to be terminated by simply pushing them in.

The conductor entry hole is perfectly suited for the insulation diameter of the rated conductor cross section, thus providing good conductor guidance.

This is particularly important for vibration-prone applications.

Fine-stranded conductors of a small or very small size are highly flexible, and deform when pushed against the conductor stop in terminal blocks. As a result, the conductor insulation – not the copper conductor – may be clamped, causing intermittent contact or no contact at all.

In order to prevent conductor insulation from being inserted into the clamp, insulation stops are available for WAGO rail-mount terminal blocks up to 4 mm² (12 AWG), even providing protection for 0.08 mm² (28 AWG) conductors.

Rated Cross Sections and Connectable Conductors

I. Per IEC 60999-1 / EN 60999-1 / VDE 0609-1, Table 1:

Rated Cross Section	Theoretical Largest Conductor Diameter							Connectable Conductor	
	Metric			AWG				Rigid	Flexible
	Rigid		Flexible	Rigid		Flexible			
	Solid	Stranded		b)	b) Class B	c) Class I, K, M Stranded			
mm ²	mm	mm	mm	Conductor Size	mm	mm	mm		
0.2	0.51	0.53	0.61	24	0.54	0.61	0.64	To be defined in the corresponding product standard	
0.34	0.63	0.66	0.8	22	0.68	0.71	0.8		
0.5	0.9	1.1	1.1	20	0.85	0.97	1.02		
0.75	1	1.2	1.3	18	1.07	1.23	1.28		
1	1.2	1.4	1.5	–	–	–	–		
1.5	1.5	1.7	1.8	16	1.35	1.55	1.6		
2.5	1.9	2.2	2.3 ^{a)}	14	1.71	1.95	2.08		
4	2.4	2.7	2.9 ^{a)}	12	2.15	2.45	2.7		
6	2.9	3.3	3.9 ^{a)}	10	2.72	3.09	3.36		
10	3.7	4.2	5.1	8	3.34	3.89	4.32		
16	4.6	5.3	6.3	6	4.32	4.91	5.73		
25	–	6.6	7.8	4	5.45	6.18	7.26		
35	–	7.9	9.2	2	6.87	7.78	9.02		

NOTE: The diameters of the largest rigid and flexible conductors are based on Table 1 of IEC 60228 A/IEC 60344 and on ASTM B172-71 [4], IEC Publication S-19-81 [5], IEC Publication S-66-524 [6], as well as IEC Publication S-66-516 [7] for AWG conductors.

^{a)} Dimensions for Class 5 flexible conductors only (IEC 60228 A)

^{b)} Nominal diameter +5%

^{c)} Largest diameter for conductors of classes I, K, M + 5%

In practical use, the conductor cross sections are approximately 5% below the values stated in the table!

The IEC 60999-1/EN 60999-1/VDE 0609-1 Specification (Section 7.1) requires that:

Clamping units must be able to connect unprepared conductors.

Under normal operating conditions, direct clamping (i.e., directly connecting a conductor to the terminal block's current bar) provides optimal contact quality, because all risk factors arising from anti-splaying methods are prevented.

Occasionally, conductor anti-splaying protection may be required, including various methods (see illustrations below).

Special requirements apply only in special application areas exposed to extremely corrosive atmospheres.

In this case, we recommend using either solid copper conductors or fine-stranded copper conductors with properly crimped, tin-coated copper ferrules or copper pin terminals.

As with solid copper conductors, the fine strands are crimped into a dense inner core. Crimping prevents ingress of aggressive atmospheres (depending on the ppm concentration), which can diffuse into the conductor bundle along the individual strands and deposit between individual strands and the clamping point.

One Conductor per Clamping Unit

A number of DIN VDE, EN, IEC directives mandate or recommend that only one conductor must be connected per clamping unit.

In accordance with DIN VDE 0611, Part 4, 02.91, Section 3.1.9, multi-level distribution rail-mount terminal blocks must be dimensioned so that a single (solid, stranded or fine-stranded) conductor of the nominal cross section can be connected at each terminal point.

Other VDE, EN and IEC specifications also recommend the connection of only one conductor per clamping unit, unless the clamping unit is specifically tested and approved for the connection of several conductors, for example:

VDE 0609, Part 1, 12.00 / EN 60999-1:2000/ IEC 60999-1:1999, Section 7.1
VDE 0660, Part 600, 06.12 / EN 61439-1:2011 / IEC 61439-1, Section 8.6.3
VDE 0113, Part 1, 06.07 / EN 60204-1:2006 / IEC 60204-1:2016, Section 13.1.1.

One conductor per clamping unit is therefore recommended to meet the safety requirements of these relevant specifications. This WAGO principle is the basis for a number of other technical and economic advantages:

- Each conductor may be terminated or removed without affecting previously connected conductors.
- Where re-wiring is required, only the conductor to be changed is removed from the clamping point, all other conductors remain safely clamped.
- Each conductor is clamped independently.
- Any conductor size combination can be connected.

WAGO rail-mount terminal blocks offer different solutions to increase the number of clamping points.

The most common way is by branching one conductor into two or three conductors. WAGO offers 3- and 4-conductor terminal blocks, making additional jumpers unnecessary.

II. Per IEC 60999-2, Table 1:

Rated Cross-Section	Theoretical Largest Conductor Diameter					Connectable Conductor	
	Metric		AWG/kcmil				
	Rigid Stranded	Fine-Stranded ^{a)}	Gauge	Rigid Stranded	Fine-Stranded	Rigid	Flexible
mm ²	mm	mm		mm	mm		
50	9.1	11	1/0	9.64	12.08	To be defined in the corresponding product standard	
70	11	13.1	2/0	11.17	13.54		
95	12.9	15.1	3/0	12.54	15.33		
–	–	–	4/0	14.08	17.22		
120	14.5	17	250	15.34	19.01		
150	16.2	19	300	16.8	20.48		
185	18	21	350	18.16	22.05		
–	–	–	400	19.42	24.05		
240	20.6	24	500	21.68	26.57		
300	23.1	27	600	23.82	30.03		

Dimensions for Class 5 flexible conductors only (IEC 60228 A)

NOTE: The diameters of the largest rigid and flexible conductors are based on Table 1 and Table 3 of IEC 3 A/IEC 60228 and on ASTM B172-71 [1], IECA Publication S-19-81 [2], IECA Publication S-66-524 [3], as well as IECA Publication S-66-516 [7] for AWG conductors.



Tip-bonded conductor



Tin-plated copper ferrule (gas-tight crimped)



Ultrasonically bonded conductor



Crimped pin terminal (gas-tight), preferably made of copper with a tin-plated surface

Anti-splaying methods require a terminal block one size larger than the nominal cross section of the conductor to be terminated. Ferruled conductor cross sections specified for individual products are based on WAGO's Variocrimp square crimping technology. Gas-tight, crimped twin ferrules may be used, provided the ferrule is inserted all the way into the clamping unit and that there is a sufficient clearance and creepage distance between adjacent potentials.

Tests and Testing Procedures per IEC/EN Standards (continued)

Mechanical Tests (continued)

- Pull-Out Test per IEC/EN 60947-7-1, IEC/EN 60998-2-2, IEC/EN 60999-1

The pull-out test simulates the mechanical stress on the clamping unit when, for example, the installer pushes the conductor aside to better access/operate the adjacent clamping unit, or verifies if the conductor is connected properly by briefly pulling on it.

During the test, a pulling force is applied without jerking, for one minute, to the connected conductor. The pulling force is selected according to the cross-sectional area. The larger the cross section of the conductor, the higher the pull-out force that is selected. For example, the pulling force is 40 N for a conductor having a cross section of 1.5 mm² (16 AWG) and 100 N for a conductor with a cross section of 16 mm² (6 AWG). The values specified by these standards are the same for both screw clamp and spring clamp terminal blocks. During the test, the conductor must neither slip out of the clamping unit, nor break near the clamping unit.

Conductor Pull-Out Forces

The clamping units of screwless terminal blocks must withstand the pull-out forces as follows:

IEC 60947-1/EN 60947-1/VDE 0660-100, Table 5:
Low-voltage switchgear and controlgear, General rules

IEC 60947-7-1/EN 60947-7-1/
VDE 0611-1, Rail-mount terminal blocks for copper conductors

IEC 60998-2-1/EN 60998-2-1/
VDE 0613-2-1, Table 104:

IEC 60998-2-2/EN 60998-2-2/
VDE 0613-2-2, Table 103:

Connecting devices for low-voltage circuits for household and similar purposes

Particular requirements for connecting devices as separate entities with screw-clamp or screwless terminal blocks.

IEC 60999-1/EN 60999-1/VDE 0609-1, Table 3:

IEC 60999-2/EN 60999-2/VDE 0609-101, Table 2:

Safety requirements for screw-clamp and screwless clamping units for electrical copper conductors

Rated Cross-Section		Pull-Out Forces per IEC/EN		
mm ²	AWG/kcmil	60947-7-1 N	60998-2-2 N	60999-1/-2 N
0.2	24	10	10	10
0.34	22	15	15	15
0.5	20	20	20	20
0.75	18	30	30	30
1	–	35	35	35
1.5	16	40	40	40
2.5	14	50	50	50
4	12	60	60	60
6	10	80	80	80
10	8	90	90	90
16	6	100	100	100
25	4	135	135	135
–	3	156		
35	2	190	190	190
–	1	236		
50	1/0	236		236
70	2/0	285		285
95	3/0	351		351
–	4/0	427		427
120	250	427		427
150	300	427		427
185	350	503		503
–	400	503		503
240	500	578		578
300	600	578		578

• Shock Test per IEC/EN 60068-2-27; IEC/EN 61373 (Railway Applications)

The shock test is similar to the vibration test except that, instead of continuous vibrations, single shocks are applied to the specimen. Shock tests are usually performed with an acceleration of 20g, for example, over a period of 11 ms. Tests for special requirements often call for much higher values.

Like the vibration tests, shock tests are primarily used to test the voltage drop variation or contact breaks, etc.

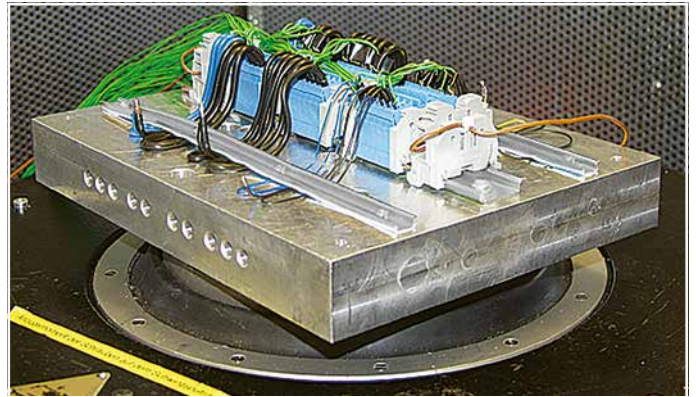
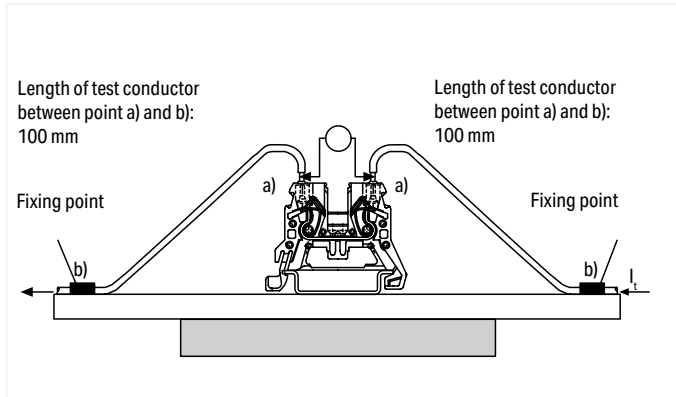

Example: Shock requirement
 per IEC/EN 60068-2-27 (half-sine shock)
 100g acceleration, 6 ms duration
 Shock direction: 3 axes (3 shocks each in positive and negative direction)

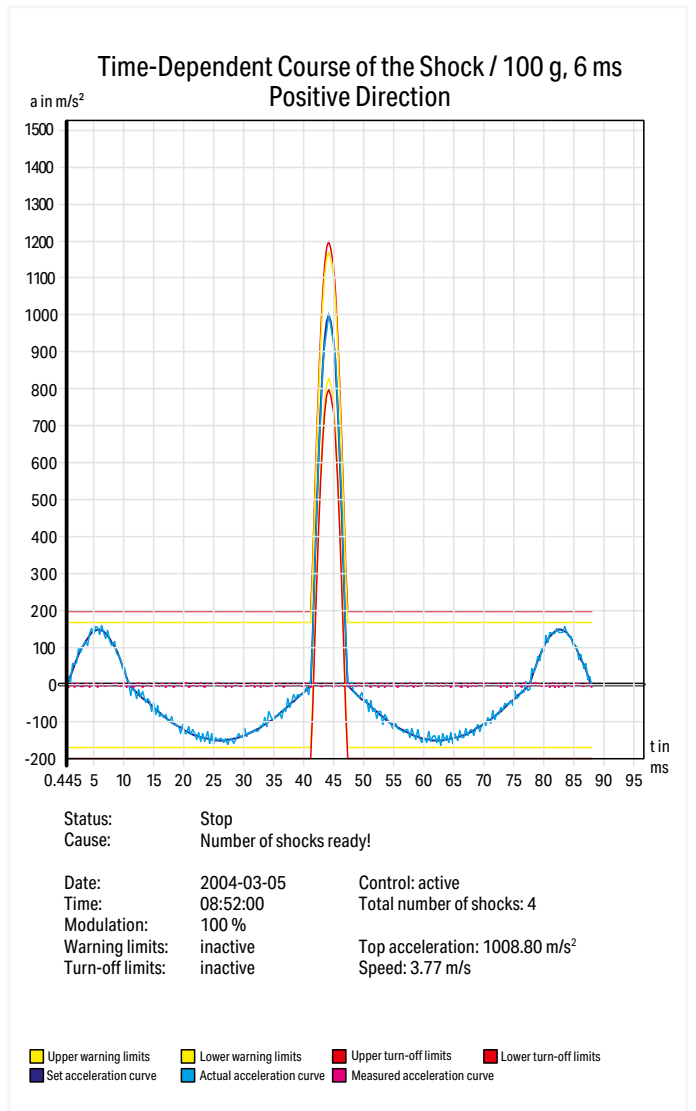
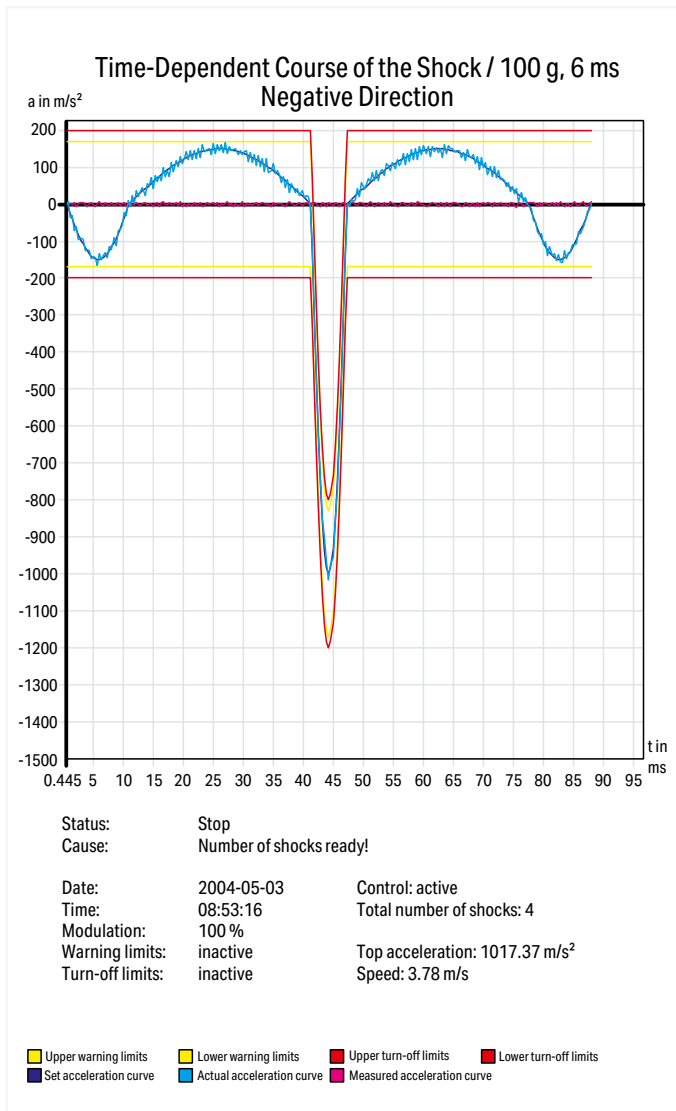

Tests and Testing Procedures per IEC/EN Standards (continued)

Mechanical Tests

- Vibration Test per IEC/EN 60068-2-6; DNV GL, LR (Marine Applications); EN 61373 (Railway Applications)

The vibration test determines whether vibrations, such as those produced in the vicinity of machines or in vehicles, will permanently affect the electrical connection, or if contact breaks will occur during vibrations. Using a vibration table, the test specimen is subjected to vibration in each of the X, Y and Z axes (see pictures).

The amplitude, acceleration and, in particular, the frequency of the vibration must vary during the test.

In a common test procedure, for example, a wide frequency band is continuously run up to 2000 Hz, at different accelerations up to 20g and different amplitudes up to 20 mm. Test duration is 90 minutes per axis.



Other test types are performed using a single fixed frequency. The exact test procedure may vary considerably, depending on how the product will be used. Some test specifications require the determination of possible resonant frequencies, i.e., determining if resonance occurs within the frequency spectrum to be passed through. Analyzing the specimen behavior under the influence of resonant frequencies is performed using a special testing procedure.

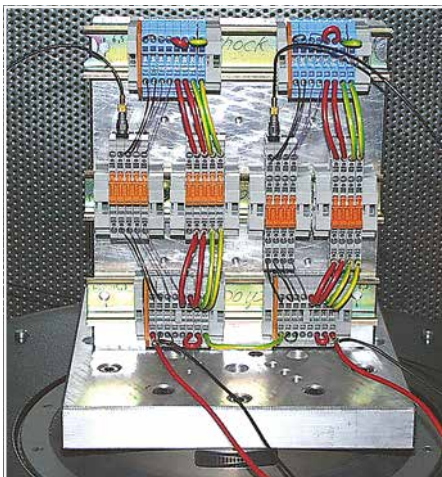

Beyond these standard procedures, each market segment performs additional testing. Examples include railway authorities testing rolling electrical equipment, or the testing performed multiple marine agencies (e.g., DNV GL Group, Lloyd's Register of Shipping). Though the requirements of such testing procedures are particularly demanding, test arrangements are identical for all of them. During vibrations, possible contact breaks are monitored on an oscilloscope. Voltage drop is measured before and after the test to detect permanent failures, i.e., checking if electrical resistance at the clamping unit has not increased beyond the permissible limit. The smaller this value is, the smaller the contact resistance of the clamping unit.

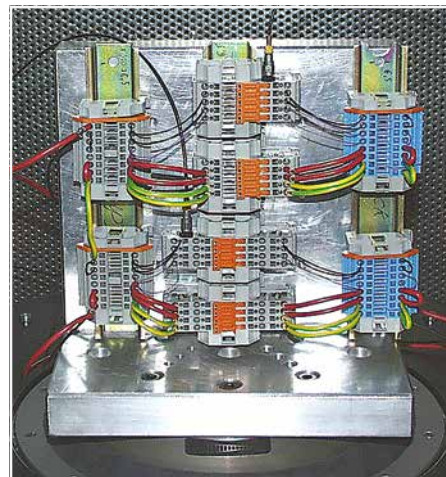

The test is passed if:

- the conductor has neither slipped out of the terminal block nor been damaged
- the maximum permissible voltage drop has not been exceeded
- and neither contact breaks have occurred nor a defined break time has been exceeded.

The test specimen must not be damaged in any way that might affect future use.

Since their inception, both CAGE CLAMP® and Push-in CAGE CLAMP® connections have been routinely tested for their resistance to vibration in connection with approval tests.

Additionally, WAGO conducts special self-resonance behavior tests on clamping systems, using different terminal block and conductor arrangements. In these tests, a wide frequency band is continuously run up to 2000 Hz, at different accelerations up to 20g and different amplitudes up to 20 mm. The figure provides an example of a self-resonance vibration test configuration.

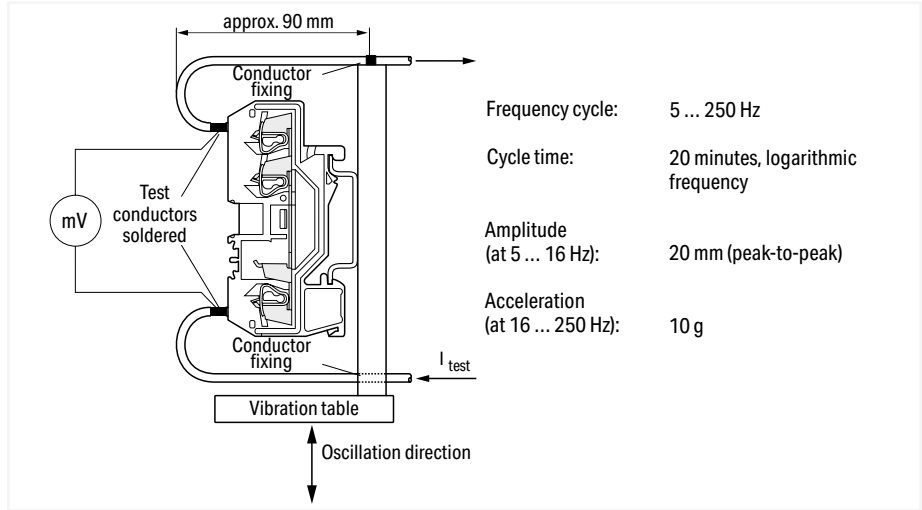

Frequency cycle: 5 ... 250 Hz
 Cycle time: 20 minutes, logarithmic frequency
 Amplitude (at 5 ... 16 Hz): 20 mm (peak-to-peak)
 Acceleration (at 16 ... 250 Hz): 10 g

Self-resonance vibration test set-up

All WAGO spring clamp connections meet these test requirements.

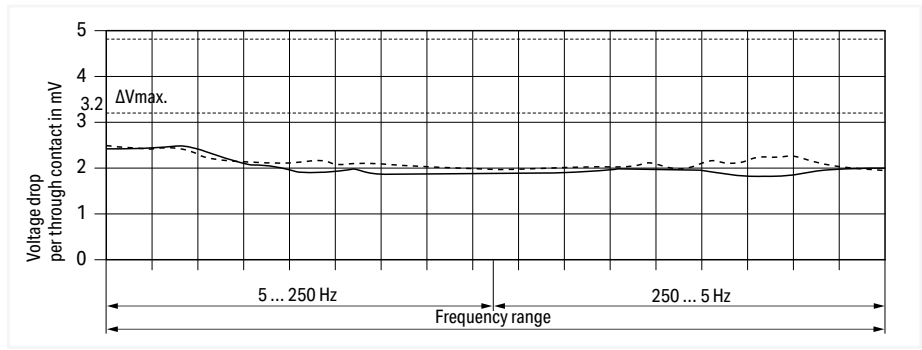

Frequency cycle: 5 ... 250 Hz, 250 ... 5 Hz
 Rail-mount terminal block: Item no. 280-681
 Test current: 1/10 I_N = 2,4 A
 ----- Test specimen no. 1
 - - - - - Test specimen no. 2

Tests and Testing Procedures per IEC/EN Standards (continued)

Electrical Tests

All WAGO products meet requirements for the following electrical tests:

- Temperature-Rise Test per IEC/EN 60947-7-1

The temperature-rise test examines the clamping unit – including the surrounding insulation – at rated current, over-current and short-circuit current levels.

Unless otherwise specified in the related equipment specification, e.g., by specifying the nominal currents of the equipment, terminal blocks and connectors are tested with current loads as specified in the respective construction specification.

For rail-mount terminal blocks complying with IEC 60947-7-1/EN 60947-7-1/VDE 0611-1, or terminal blocks complying with IEC 60998-1/EN 60998-1/ VDE 0613-1, the temperature rise must not exceed 45 Kelvin.

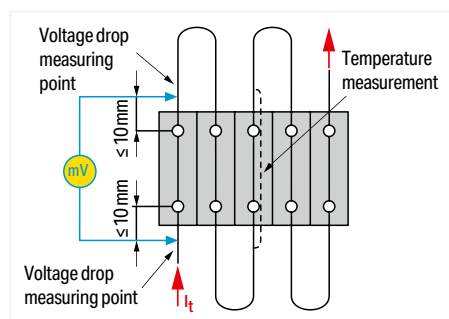

Test arrangement: "Temperature-Rise Test"

Rated Cross-Section	Test Current per IEC/EN		Conductor Size	Test Current per IEC/EN
	60947-7-1 Table 4	60998-1 Table 2		
mm ²	A	A	AWG/kcmil	A
0.2	4	4	24	4
0.34	5	5	22	6
0.5	6	6	20	8
0.75	9	9	18	10
1	13.5	13.5	-	16
1.5	17.5	17.5	16	16
2.5	24	24	14	22
4	32	32	12	29
6	41	41	10	38
10	57	57	8	50
16	76	76	6	67
25	101	101	4	90
35	125	125	2	121
-			1	139
50	150		1/0	162
70	192		2/0	185
95	232		3/0	217
-			4/0	242
120	269		250 kcmil	271
150	309		300 kcmil	309
185	353		350 kcmil	353
240	415		500 kcmil	415
300	520		600 kcmil	520

• Current-Carrying Capacity Curve per IEC/EN 60512-5-2

Both the design requirements and the current-carrying capacity of a connector must be checked by the user when selecting connectors. This data depends on the following factors: connected conductor cross section, surrounding air temperature, number of simultaneously loaded poles, connector's internal resistance, as well as PCB layout and connector materials if required. In accordance with IEC/EN 60512-5-2, the relationship between current, surrounding air temperature and temperature rise up to the connector's upper temperature limit is illustrated via current-carrying capacity curve. The connector must only be operated up to this temperature limit (sum of the self-generated heat and the surrounding air temperature) without being damaged or destroyed during operation.

Functioning of a current-carrying capacity curve per EN 60512-5-2 is shown by an application using a current-carrying capacity curve for the X-COM®-SYSTEM:

This application requires each pole of a 4-pole connector be subjected to a load of 32 A. Based on the basic curve determined for this pole number with a conductor cross section of 4 mm², it has been determined the maximum surrounding air temperature is 42°C (107.6°F). The current must be reduced at higher surrounding air temperatures, e.g., to 19 A at an surrounding air temperature of 80°C (176°F).

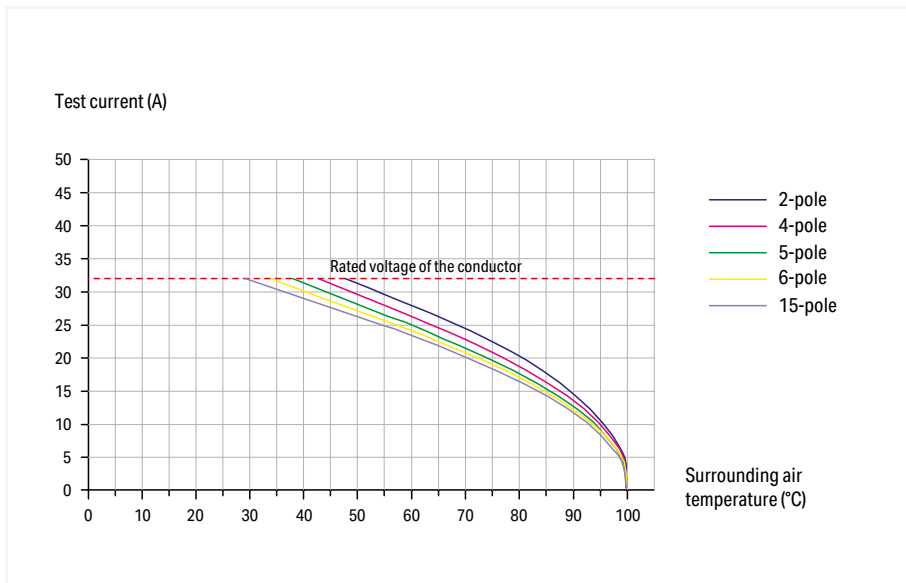

1-conductor/1-pin carrier terminal block (769-176)
Conductor cross section: 4 mm² (12 AWG)

1-conductor female plugs (769-102 to 769-115)
Conductor cross section: 4 mm² (12 AWG)
Conductor loop length: 1 m

Tests and Testing Procedures per IEC/EN Standards (continued)

Electrical Tests (continued)

- Voltage Drop Test per IEC/EN 60947-7-1

The voltage drop test evaluates clamping point quality under stress such as vibration, temperature change, industrial climate and salt spray, in order to verify that the contact point is gas-tight.

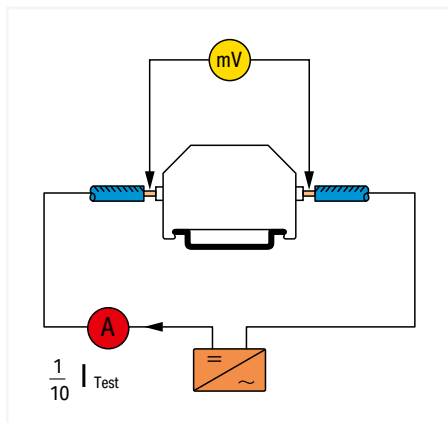

The CAGE CLAMP® and Push-in CAGE CLAMP® connections enclose and contain fine-stranded conductors. Therefore, a variation of the voltage drop with solid and fine-stranded conductors is so small that its influence may be negligible for the practical application of the terminal blocks.

Test arrangement: "Voltage Drop Test"

Typical voltage drop variations for solid and fine-stranded conductors of 280 to 285 Series CAGE CLAMP® Rail-Mount terminal Blocks:

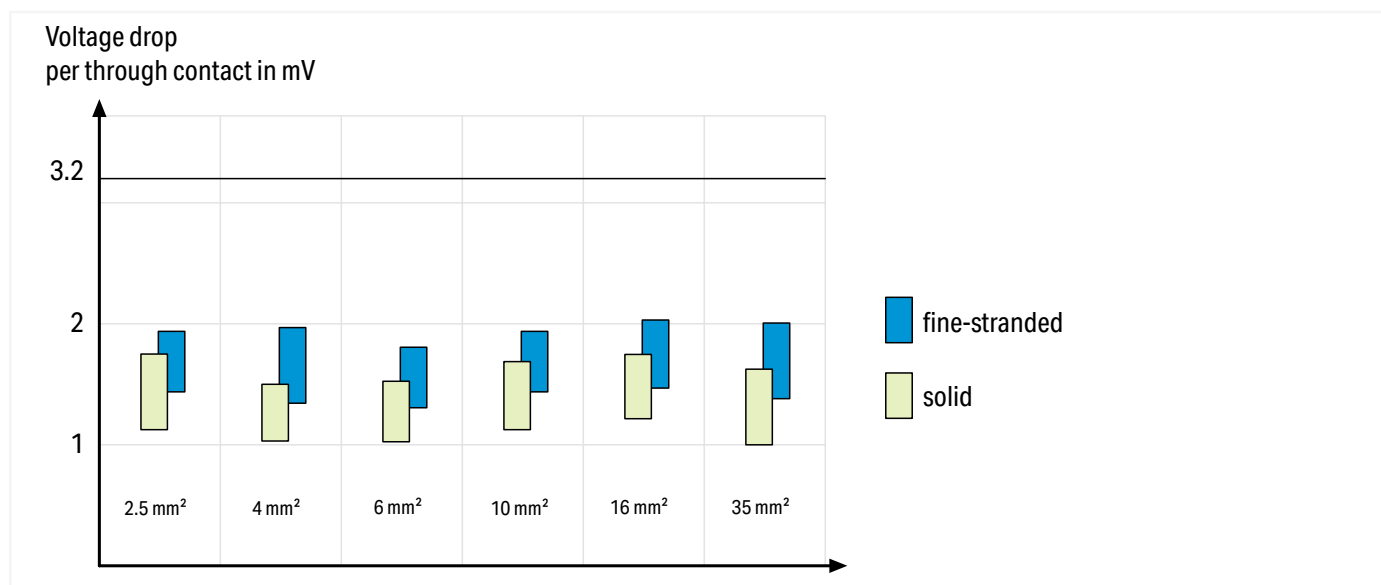

Example: Current load cycling test result for rail-mount terminal blocks (item no. 285-195) using 95 mm² (4/0 AWG) fine-stranded copper conductors:

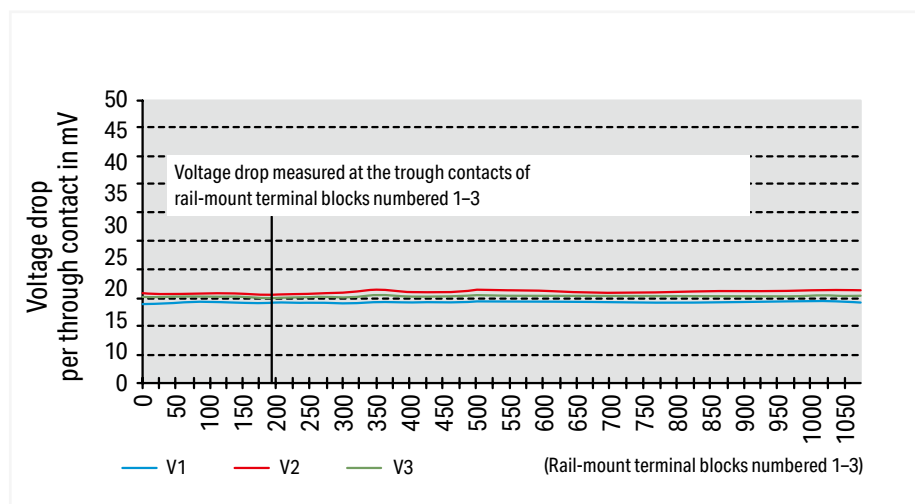

Voltage drop variation over longer periods under current load cycling conditions is shown for WAGO 285-195 (95 mm²/4/0 AWG) Rail-Mount Terminal Blocks using solid copper conductors. The diagram shows that the voltage drop is constant, far beyond the 192 cycles required in IEC 60947-7-1.

(The voltage drop was determined at the rated current.)

- Short-Time Withstand Current Test (Short-Circuit Withstand Capacity) per IEC/EN 60947-7-1

Apart from the rated current that can be constantly applied to an electrical device, operation-related short peak currents consistently occur in electrical installations, e.g., when motors are started. Also, in the event of a short circuit, a high current can flow for a short time until the fuse element melts. Terminal blocks and connecting devices must be able to withstand such conditions. For example, in the short-time withstand current test per IEC/EN 60947-7-1, a through rail-mount terminal blocks must be capable of withstanding for one second the rated short-time withstand current which corresponds to 120 A/mm^2 of its nominal cross section.

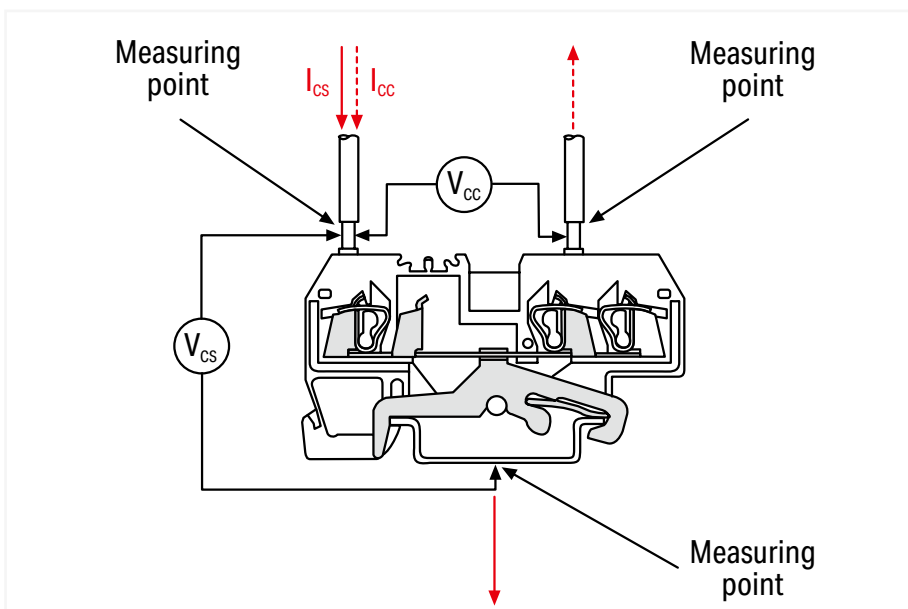
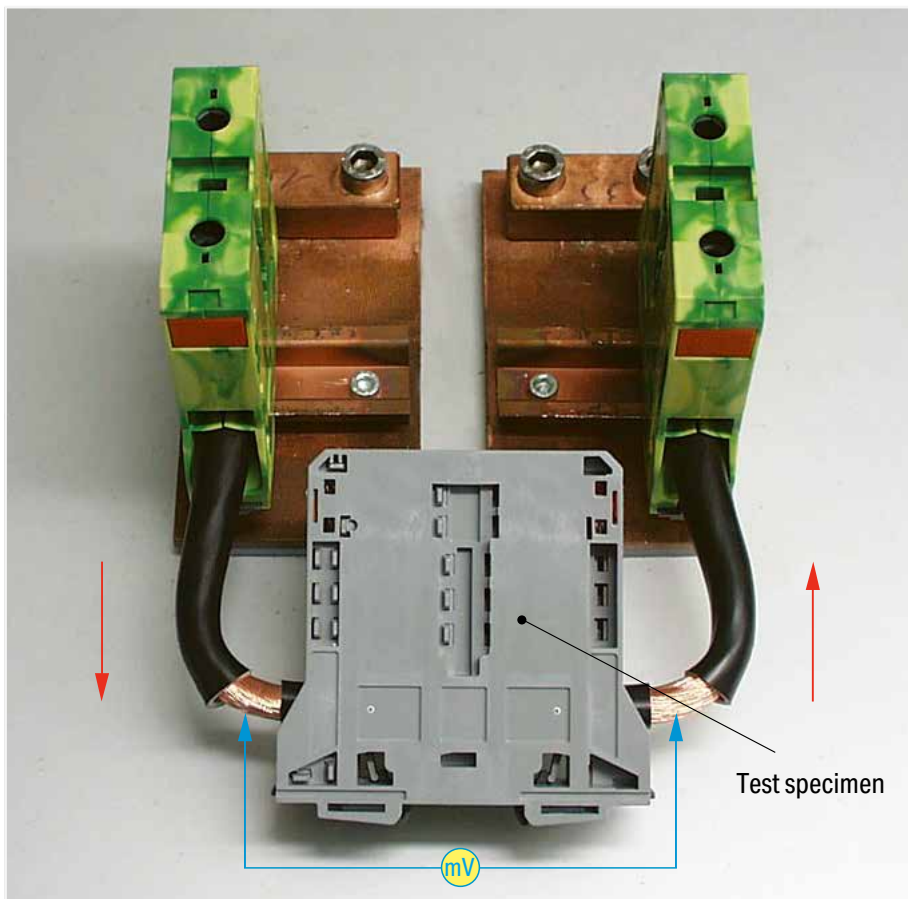

During the short-time withstand current test, the ground conductor rail-mount terminal blocks are subjected three times for one second each to a current load of 120 A/mm^2 . The pass criterion for the test is the voltage drop (limiting value and constant measured values).

Tests and Testing Procedures per IEC/EN Standards (continued)

Electrical Tests (continued)

• Insulation Parameters per IEC/EN 60664-1

Clearances and Creepage Distances

The following generally applies:

The equipment specification contains data for the measurement of clearances and creepage distances, or refers to the data contained in the new revised edition of the basic standard DIN EN 60664-1/VDE 0110-1. This standard contains new clearances and creepage distances in compliance with insulation coordination requirements. That is, the insulation parameters of equipment are assigned to:

- the anticipated surge voltages
- the parameters of the protection device against impulse voltage
- the anticipated environmental conditions and the protection measures against pollution.

This standard is based on IEC 60604-1.

Overvoltage Categories for Electrical Equipment:

A specific overvoltage category must be defined on the basis of the following, general description:

- Equipment in **overvoltage category I** is intended to be connected to the fixed electrical installations of buildings. Protective means are taken outside the equipment – either in the fixed installation or between the fixed installation and the equipment – to limit transient overvoltages to the specific level.
- Equipment in **overvoltage category II** is to be connected to the fixed electrical installations of buildings.
Note: Examples of such equipment are household appliances, portable tools and similar loads.
- Equipment in **overvoltage category III** is part of the fixed electrical installations and other equipment where a higher degree of availability is expected.
Note: Examples of such equipment are distribution boards, circuit breakers, wiring systems (IEV 826-16-08, including cables, bus bars, junction boxes, switches, socket outlets) in the fixed installation and equipment for industrial use and other equipment, e.g., stationary motors with permanent connection to the fixed installation.
- Equipment in **overvoltage category IV** is for use in or near the feed-in of electrical building installations upstream of the main distribution board in the direction of the network.
Note: Examples include electricity meters, primary overcurrent protection devices and ripple control units.

Clearances, Rated Surge Voltages, Overvoltage Categories, Pollution Degrees

Surge voltages (Table 1) are a decisive factor in determining clearances.

The basis forms the **overvoltage category**, i.e., the allocation of the equipment to the expected overvoltage, and the **conductor-ground voltage** derived from the nominal mains voltage in installations with a grounded Y (star) point.

In ungrounded installations, or installations where the conductor is not grounded, the voltage between conductors is applicable in the same way as conductor voltage to ground.

The rated surge voltage must be selected from Table F.1 corresponding to the overvoltage category specified and to the rated voltage of the equipment.

Table F.1 – Rated Surge Voltage for Equipment Energized Directly from the Low-Voltage Mains (DIN EN 60664-1/VDE 0110-1)

Voltage Curve: 1.2/50 μ s per IEC 60060-1/VDE 0432-1

Nominal voltage of the power supply system ¹⁾ (mains) per IEC 60038 ²⁾		Conductor-to-neutral voltage, derived from the nominal AC or DC voltage up to and including: V	Rated surge voltage ²⁾			
Three-phase V	Single-phase V		Overvoltage category ⁴⁾			
			I V	II V	III V	IV V
		50	330	500	800	1500
		100	500	800	1500	2500
	120 ... 240	150 ⁵⁾	800	1500	2500	4000
230 / 400 277 / 480		300	1500	2500	4000	6000
400 690		600	2500	4000	6000	8000
1000		1000	4000	6000	8000	12000

¹⁾ See Annex B for application to existing different low-voltage mains and their nominal voltages.

²⁾ Equipment with these rated impulse voltage levels can be used in installations complying with IEC 60364-4-443.

³⁾ The / mark indicates a 3-phase, 4-conductor system. The lower value is the conductor-to-neutral voltage, while the higher value is the conductor-to-conductor voltage. Where only one value is indicated, it refers to 3-phase, 3-conductor systems and specifies the conductor-to-conductor voltage.

⁴⁾ See 4.3.3.2.2 for an explanation of the overvoltage categories.

⁵⁾ The nominal voltages for single-phase systems in Japan are 100 V or 100 ... 200 V. The value for the rated impulse voltage is, however, derived from the voltage gaps conductor-to-neutral for a voltage level of 150 V (see Annex B).

The nominal supply voltage and the corresponding rated impulse voltage values apply for grounded and ungrounded circuits.

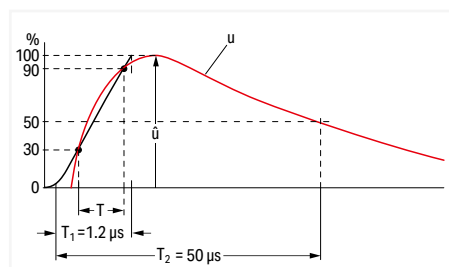

Voltage pulse: 1.2/50 μ s per EN 60060-1/VDE 0432-1

Pollution Degrees

Pollution factors are all solid, liquid or gaseous foreign matter which may reduce the dielectric strength or the specific surface resistance. Factors are divided into four classes based on expected environmental conditions:

		Examples of pollution degrees for assigned areas:
Pollution degree 1:	No pollution, or only dry, non-conductive pollution occurs. Pollution has no influence.	Open, unprotected insulated equipment in air-conditioned or clean, dry rooms
Pollution degree 2:	Only non-conductive pollution occurs. Occasional, temporary conductivity caused by condensation can also be expected.	Open, unprotected insulated equipment in occupied areas, shops, laboratories, mechanical workshops and medical rooms.
Pollution degree 3:	Conductive pollution occurs, or dry, non-conductive pollution occurs which will become conductive due to condensation.	Open, unprotected insulated equipment in industrial, business and farming areas (e.g., unheated rooms, workshops and boiler rooms)
Pollution degree 4:	The pollution generates persistent conductivity caused by conductive dust, rain or wet conditions.	Open, unprotected insulated equipment for outdoor use

Dimensioning Clearances

(DIN EN 60664-1/VDE 0110-1, Table F.2)

Select the minimum clearances in accordance with the rated surge voltages and pollution degrees. To maximize the operating life of the equipment, do not go below these minimum clearances.

Table F.2 contains a list of information for Case A, the inhomogeneous field and for Case B, the homogeneous field.

This involves an electric field with essentially constant (Case B) or non-constant (Case A) voltage gradients between the electrodes.

Equipment with a clearance that is dimensioned per Case A, in other words rated for the most unfavorable case, requires no verification by the impulse voltage test.

Equipment with a clearance that is dimensioned per Case B, or between A and B, requires verification by the impulse voltage test.

The clearances shown in Table F.2 are applicable for an installation height of up to 2000 m above sea level.

Values for clearances above 2000 m must be multiplied by a high correction factor in accordance with Table A.2.

Table F.2 – Clearances to Withstand Transient Overvoltages
DIN EN 60664-1/VDE 0110-1

Required Impulse Withstand Voltage ¹⁾⁵⁾	Minimum Clearances in Air up to 2000 m Above Sea Level					
	Case A Inhomogeneous Field (see 3.15)			Case B Homogeneous Field (see 3.14)		
	Pollution Degree ⁶⁾			Pollution Degree ⁶⁾		
	1	2	3	1	2	3
kV	mm	mm	mm	mm	mm	
0.33 ²⁾	0.01	0.2 ³⁾⁴⁾	0.8 ⁴⁾	0.01	0.2 ³⁾⁴⁾	0.8 ⁴⁾
0.4	0.02			0.02		
0.5 ²⁾	0.04			0.04		
0.6	0.06			0.06		
0.8 ²⁾	0.10			0.10		
1	0.15			0.15		
1.2	0.25	0.25	0.2	0.3	0.3	
1.5 ²⁾	0.5	0.5	0.3	0.45	0.45	
2	1	1	1	0.6	0.6	
2.5 ²⁾	1.5	1.5	1.5	0.8	0.8	
3	2	2	2	1.2	1.2	1.2
4 ²⁾	3	3	3	1.5	1.5	1.5
5	4	4	4	2	2	2
6 ²⁾	5.5	5.5	5.5	3	3	3
8 ²⁾	8	8	8	3.5	3.5	3.5
10	11	11	11	4.5	4.5	4.5
12 ²⁾	14	14	14	5.5	5.5	5.5
15	18	18	18	8	8	8
20	25	25	25	10	10	10
25	33	33	33	12.5	12.5	12.5
30	40	40	40	17	17	17
40	60	60	60	22	22	22
50	75	75	75	27	27	27
60	90	90	90	35	35	35
80	130	130	130	45	45	45
100	170	170	170			

¹⁾ This voltage is for:

- Functional insulation: the maximum impulse voltage expected to occur across the clearance (see 5.1.5)
- Basic insulation directly exposed to or significantly influenced by transient overvoltages from the low-voltage mains (see 4.3.3.3, 4.3.3.4.1 and 5.1.6): the rated impulse voltage for the equipment;
- Other basic insulation (see 4.3.3.4.2): the highest impulse voltage that can occur in the circuit
For reinforced insulation, see 5.1.6.

²⁾ Preferred values specified in 4.2.3

³⁾ For printed wiring material, the values for pollution degree 1 apply, except that the value must not be less than 0.04 mm, as specified in Table F.4.

⁴⁾ The minimum clearances given for pollution degree 2 and 3 are based on the reduced withstand characteristics of the associated creepage distance under humidity conditions (see IEC 60664-5).

⁵⁾ For parts or circuit within equipment subject to surge voltages based on 4.3.3.4.2, interpolation of values is allowed. However, standardization is achieved by using the preferred series of impulse voltage values based on 4.2.3.

⁶⁾ The dimensions for pollution degree 4 are as specified for pollution degree 3, except that the minimum clearance is 1.6 mm.

Tests and Testing Procedures per IEC/EN Standards (continued)

Electrical Tests (continued)

- Insulation Parameters per IEC/EN 60664-1 (continued)



Creepage Distances, Rated Voltages, Material Groups

Criteria for dimensioning creepage distances are the rated voltages, pollution degrees and material groups.

The pollution degrees specified for the clearances, and its quoted allocation to locations, is also applicable for creepage distances.

Tables F.3 a and F.3 b of DIN EN 60664-1/ VDE 0110-1 contain the rated voltages that have to be considered for dimensioning the minimum creepage distances.

Table F.3a – Single-Phase, 3- or 2-Conductor, AC or DC Systems

Nominal Voltage of the Power Supply System (Mains)*	Voltages for Table F.4	
	For insulation conductor-to-conductor ¹⁾	For insulation conductor-to-ground ¹⁾
	All systems 	Three-conductor systems, center-point grounded 
V	V	V
12.5	12.5	
24 25	25	
30	32	
42 48 50**	50	
60	63	
30 to 60	63	32
100**	100	
110 120	125	
150**	160	
200	200	
110 to 200	200	100
220	250	
110 to 220 120 to 240	250	
300**	320	
220 to 440	500	250
600**	630	
480 to 960	1000	500
1000**	1000	

¹⁾ Conductor-to-ground insulation level for non-grounded or impedance-grounded systems equals that for conductor-to-conductor, as the operating voltage to ground of any conductor can, in practice, approach full conductor-to-conductor voltage. This is because the actual voltage to ground is determined by the insulation resistance and capacitive reactance of each conductor to ground; thus, low (but acceptable) insulation resistance of one conductor can in effect ground it and raise the other two to full conductor-to-conductor voltage to ground.

*For the relationship to rated voltage, see 4.3.2.

**These values correspond to the values given in Table F.1.

Altitude m	Standard Air Pressure (in kPa)	Multiplier for Clearances
2000	80	1
3000	70	1.14
4000	62	1.29
5000	54	1.48
6000	47	1.7
7000	41	1.95
8000	35.5	2.25
9000	30.5	2.62
10000	26.5	3.02
15000	12	6.67
20000	5.5	14.5

Table F.3b – Single-Phase, 4- or 3-Conductor AC Systems

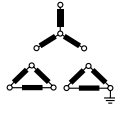
Nominal Voltage of the Power Supply System (Mains)*	Voltages for Table F.4		
	For insulation conductor-to-conductor ¹⁾	For insulation conductor-to-ground ¹⁾	
	All systems	Three-phase, 4-conductor systems with grounded neutral conductor ²⁾	Three-phase, 3-conductor systems, non-grounded ¹⁾ or grounded conductor
V	V		
V	V	V	V
60	63	32	63
110 120 127	125	80	125
150**	160		160
200	200		200
208	200	125	200
220 230 240	250	160	250
300**	320		320
380 400 415	400	250	400
440	500	250	500
480 500	500	320	500
575	630	400	630
600**	630		630
660 690	630	400	630
720 830	800	500	800
960	1000	630	1000
1000**	1000		1000

¹⁾ Conductor-to-ground insulation level for non-grounded or impedance-grounded systems equals that for conductor-to-conductor, as the operating voltage to ground of any conductor can, in practice, approach full conductor-to-conductor voltage. This is because the actual voltage to ground is determined by the insulation resistance and capacitive reactance of each conductor to ground; thus, low (but acceptable) insulation resistance of one conductor can in effect ground it and raise the other two to full conductor-to-conductor voltage to ground.

²⁾ For equipment used on both three-phase, 4-conductor and three-phase, 3-conductor systems, grounded and non-grounded, use only the values for 3-conductor systems.

*For the relationship to rated voltage, see 4.3.2.

**These values correspond to the values given in Table F.1.

Material Groups

Insulation materials are classified into four groups according to their Comparative Tracking Index (CTI) as follows:

Material Group I: $600 \leq \text{CTI}$

Material Group II: $400 \leq \text{CTI} < 600$

Material Group IIIa: $175 \leq \text{CTI} < 400$

Material Group IIIb: $100 \leq \text{CTI} < 175$

The CTI values above refer to values obtained in accordance with DIN EN 60664-1/VDE 0110-1 on samples specially made for this purpose and tested with Solution A.

Tests and Testing Procedures per IEC/EN Standards (continued)

Electrical Tests (continued)

• Insulation Parameters per IEC/EN 60664-1 (continued)

Table F.4 – Creepage Distances to Avoid Failure due to Tracking
DIN EN 60664-1/VDE 0110-1

Voltage ¹⁾ (RMS)	Minimum Creepage Distances								
	Printed Circuits		Pollution Degree						
	Pollution Degree		Pollution Degree						
	1 All Material Groups mm	2 All Material Groups except IIIb mm	1 All Material Groups mm	2 Material Group I mm	2 Material Group II mm	2 Material Group III mm	3 Material Group I mm	3 Material Group II mm	3 Material Group III ²⁾ mm
V									
10	0.025	0.04	0.08	0.4	0.4	0.4	1	1	1
12.5	0.025	0.04	0.09	0.42	0.42	0.42	1.05	1.05	1.05
16	0.025	0.04	0.1	0.45	0.45	0.45	1.1	1.1	1.1
20	0.025	0.04	0.11	0.48	0.48	0.48	1.2	1.2	1.2
25	0.025	0.04	0.125	0.50	0.5	0.5	1.25	1.25	1.25
32	0.025	0.04	0.14	0.53	0.53	0.53	1.3	1.3	1.3
40	0.025	0.04	0.16	0.56	0.8	1.1	1.4	1.6	1.8
50	0.025	0.04	0.18	0.6	0.85	1.2	1.5	1.7	1.9
63	0.04	0.063	0.2	0.63	0.9	1.25	1.6	1.8	2
80	0.063	0.1	0.22	0.67	0.95	1.3	1.7	1.9	2.1
100	0.1	0.16	0.25	0.71	1	1.4	1.8	2	2.2
125	0.16	0.25	0.28	0.75	1.05	1.5	1.9	2.1	2.4
160	0.25	0.4	0.32	0.8	1.1	1.6	2	2.2	2.5
200	0.4	0.63	0.42	1	1.4	2	2.5	2.8	3.2
250	0.56	1	0.56	1.25	1.8	2.5	3.2	3.6	4
320	0.75	1.6	0.75	1.6	2.2	3.2	4	4.5	5
400	1	2	1	2	2.8	4	5	5.6	6.3
500	1.3	2.5	1.3	2.5	3.6	5	6.3	7.1	8 (7.9) ⁴⁾
630	1.8	3.2	1.8	3.2	4.5	6.3	8 (7.9) ⁴⁾	9 (8.4) ⁴⁾	10 (9) ⁴⁾
800	2.4	4	2.4	4	5.6	8	10 (9) ⁴⁾	11 (9.6) ⁴⁾	12.5 (10.2) ⁴⁾
1000	3.2	5	3.2	5	7.1	10	12.5 (10.2) ⁴⁾	14 (11.2) ⁴⁾	16 (12.8) ⁴⁾
1250			4.2	6.3	9	12.5	16 (12.8) ⁴⁾	18 (14.4) ⁴⁾	20 (16) ⁴⁾
1600			5.6	8	11	16	20 (16) ⁴⁾	22 (17.6) ⁴⁾	25 (20) ⁴⁾
2000			7.5	10	14	20	25 (20) ⁴⁾	28 (22.4) ⁴⁾	32 (25.6) ⁴⁾
2500			10	12.5	18	25	32 (25.6) ⁴⁾	36 (28.8) ⁴⁾	40 (32) ⁴⁾
3200			12.5	16	22	32	40 (32) ⁴⁾	45 (36) ⁴⁾	50 (40) ⁴⁾
4000			16	20	28	40	50 (40) ⁴⁾	56 (44.8) ⁴⁾	63 (50.4) ⁴⁾
5000			20	25	36	50	63 (50.4) ⁴⁾	71 (56.8) ⁴⁾	80 (64) ⁴⁾
6300			25	32	45	63	80 (64) ⁴⁾	90 (72) ⁴⁾	100 (80) ⁴⁾
8000			32	40	56	80	100 (80) ⁴⁾	110 (88) ⁴⁾	125 (100) ⁴⁾
10000			40	50	71	100	125 (100) ⁴⁾	140 (112) ⁴⁾	160 (128) ⁴⁾
12500			50 ³⁾	63 ³⁾	90 ³⁾	125 ³⁾			
16000			63 ³⁾	80 ³⁾	110 ³⁾	160 ³⁾			
20000			80 ³⁾	100 ³⁾	140 ³⁾	200 ³⁾			
25000			100 ³⁾	125 ³⁾	180 ³⁾	250 ³⁾			
32000			125 ³⁾	160 ³⁾	220 ³⁾	320 ³⁾			
40000			160 ³⁾	200 ³⁾	280 ³⁾	400 ³⁾			
50000			200 ³⁾	250 ³⁾	360 ³⁾	500 ³⁾			
63000			250 ³⁾	320 ³⁾	450 ³⁾	600 ³⁾			

¹⁾ This voltage is for:

- Functional insulation; the working voltage
- Basic and supplementary insulation of the circuit energized directly from the mains (see 4.3.2.2.1): for the voltage rationalized through Table F.3a or F.3b, based on the rated voltage of the equipment, or the rated insulation voltage
- Basic and supplementary insulation of systems, equipment and internal circuits not energized directly from the mains (see 4.3.2.2.2): the highest rms voltage which can occur in the system, equipment or internal circuit when supplied at rated voltage and under the most taxing combination of operation conditions within equipment rating

²⁾ Material group IIIb is not recommended for applications in pollution degree 3 above 630 V.

³⁾ Provisional data based on extrapolation. Technical committees who have other information based on experience may use their dimensions.

⁴⁾ The values in brackets must only be applied for reducing creepage distances if a rib is used (see 5.2.5).

The high degree of accuracy of the creepage distances given in the table does not imply that the measuring accuracy must be of the same quality.

Depending on the intended use, WAGO's terminal blocks, splicing and pluggable connectors are suitable for pollution degrees 2 or 3 and for overvoltage categories II or III.

Example:

WAGO Rail-Mount Through Terminal Blocks
per IEC 60947-7-1/
EN 60947-7-1/VDE 0611-1, these blocks have the following ratings:

800 V / 8 kV / 3

Rated voltage:	800 V
Rated surge voltage	8 kV
Pollution Degree	3
Overvoltage category	III

WAGO's connectors for household and similar mounted installations are rated per IEC 60998-1 / EN 60998-1 / VDE 0613-1, Table 3.

Example:

WAGO PUSH WIRE® Connectors for Junction Boxes

According to this standard, these connectors are rated for:

*400 V / 4 kV / 2

*grounded circuits

Rated voltage:	400 V
Rated surge voltage	4 kV
Pollution Degree	2
Overvoltage category	II

Table 3 – Clearances and Creepage Distances
(IEC/EN 60998-1)

Rated Insulation Voltage V	Clearances/Creepage Distances mm
≤ 130	1.5
> 130 and ≤ 250	3
> 250 and ≤ 450	4
> 450 and ≤ 750	6
> 750	8

Tests and Testing Procedures per IEC/EN Standards (continued)

Electrical Tests (continued)

• Power-Frequency Withstand Voltage Test per IEC/EN 60947-7-1, IEC/EN 60947-1

This testing procedure verifies creepage distances. Creepage distances, i.e., the distances of creeping currents, are caused by conductive impurities on the surface of the insulation housing. Apart from the amount of impurities to which a terminal block is subjected, for example, the plastic material and housing design are also involved in generating creeping currents. The insulation material of the housing may be carbonized by a creeping current, which further increases conductivity.

The specimen is tested using a power-frequency withstand voltage for a short time. For example, a rail-mount terminal block designed to operate at 800 V nominal voltage is usually tested using 2000 V alternating voltage for one minute. The test is passed if no flashovers or breakdowns have occurred.

• Rated Impulse Withstand Voltage Test per IEC/EN 60947-7-1, IEC/EN 60947-1

This test verifies the clearances of a product. In simplified terms, clearance is the distance between two poles of a terminal block. If this distance is too small, voltage peaks may cause flashovers or breakdowns. The arrangement of the rated impulse withstand voltage test is identical to that of the power frequency withstand voltage test; the test voltages, however, are comparatively higher and the testing times shorter, e.g., 9.8 kV over 50 μ s (see figure).

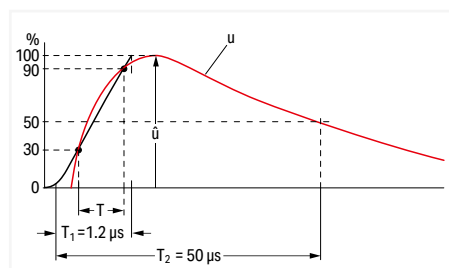

Voltage pulse: 1.2/50 μ s per EN 60060-1/VDE 0432-1

Voltage pulse: measurement curve (red) and auxiliary curve (black) for calculating the rate of rise of the pulse and the resulting (virtual) peak of the curve.

T: Time interval for calculating the rate of rise
 T1: Front time (duration between start of impulse and reaching the peak)
 T2: Total pulse duration

The test values are the values at sea level as specified in the relevant test specification. The values indicated in the catalog correspond to an altitude of 2000 m. The test is passed if no flashovers or breakdowns have occurred.

• IP Ratings for Electrical Equipment per IEC/EN 60529

Alphanumeric Nomenclature for Type of Protection			IP vs. NEMA		
Code letters IP	Protection against accidental contact and against the penetration of foreign objects or water	IP (Ingress Protection) = International degree of protection		IP Code	NEMA
First code number 0 to 6	Indicates the degree of protection against accidental contact and the penetration of foreign objects.	If indicating the degree of protection requires only one digit, the other (second) digit must be substituted for with an X.		10	1
Second code number 0 to 8	Indicates the degree of protection against water penetration.			11	2
First code number:		54	3	14	3R
Second code number:		54	3S	54	3S
IP0X	No protection against accidental contact or the penetration of foreign objects	IPX0	No protection against water	55	4&4X
IP1X	Protection against foreign objects > 50 mm	IPX1	Protection against vertically falling water	52	5
IP2X	Protection against foreign objects > 12 mm (e.g., finger)	IPX2	Protection against diagonally dripping water (15° angle)	67	6&6P
IP3X	Protection against foreign objects > 2.5 mm	IPX3	Protection against water spray	52	12&12K
IP4X	Protection against foreign objects > 1 mm	IPX4	Protection against water spray	54	13
IP5X	Protection against damaging dust deposits	IPX5	Protection against water jet, e.g., from a nozzle		
IP6X	Protection against dust penetration	IPX6	Protection against flooding		
		IPX7	Protection against temporary immersion		
		IPX8	Protection against continuous immersion		
		IPX9	Protection against high-pressure and high-temperature water jets		

Tests and Testing Procedures per IEC/EN Standards (continued)

Material Tests

All WAGO products meet requirements for the following material tests:

- Needle Flame Test per IEC/EN 60947-7-1, IEC/EN 60695-11-5

This test simulates flames that may arise under certain conditions (e.g. fault current over a creepage distance, overloading of parts or components). Nearby parts can also be affected by such flames.

Not only the ignition of the test specimen resulting from an intrinsic defect is tested, but also its behavior when other parts ignite.

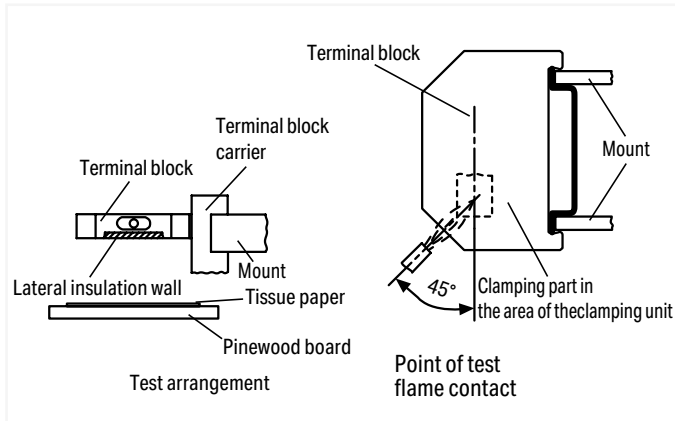

Flames must not be fuelled by the insulation materials used, thus creating a larger fire. The test specimen is exposed to a standard gas flame during a defined time period (e.g., ten seconds).

After the test flame has been removed, the specimen must self-extinguish within 30 seconds. Furthermore, a layer of tissue paper located beneath the specimen must not be ignited by glowing particles falling from the specimen.

- Glow-Wire Test per IEC/EN 60998-1, IEC/EN 60695-2-11

In the event of failure, a high current may cause a conductor to glow.



However, the glowing conductor shall not cause ignition of the product involved (e.g., a rail-mount terminal block). For the glow-wire test, the tip of the glow-wire is pressed against a surface of the test specimen (see picture).

The position of the test specimen, surface to be tested, test duration and glow-wire temperature (e.g., 960°C/1760°F over 30 seconds, or 850°C/1562°F over 5 seconds) are specified in the standards.

The specimen must be positioned such that the tip of the glow-wire acts on the surface section of the specimen (vertical surface of the specimen) that is most likely to be exposed to thermal loading during normal use.

As the highest temperature in the event of a fault is anticipated at the contact insert/wire connection, the tip of the glow-wire must act upon the section of the insulation housing that is the closest to this contact point.

The test is passed if there are no visible flames or permanent glowing, or if flames or glowing extinguish within 30 seconds after removal of the glow-wire. Furthermore, a layer of tissue paper located beneath the specimen must not be ignited by glowing particles falling from the specimen.

Tests and Testing Procedures per IEC/EN Standards (continued)

Environmental Tests

The following tests show how a product reacts when exposed to an aggressive environment. Climatic chambers simulate standard atmospheres that could impact the long-term consistency of clamping units.

All WAGO products meet the requirements of the following environmental tests:

- Temperature Cycling Test per IEC/EN 60947-7-1, IEC/EN 60998-2-2

This test shows the change of voltage drop over longer periods under temperature cycling conditions. The test procedure usually consists of 192 temperature cycles, for example, each cycle having a duration of 60 minutes (see diagram).

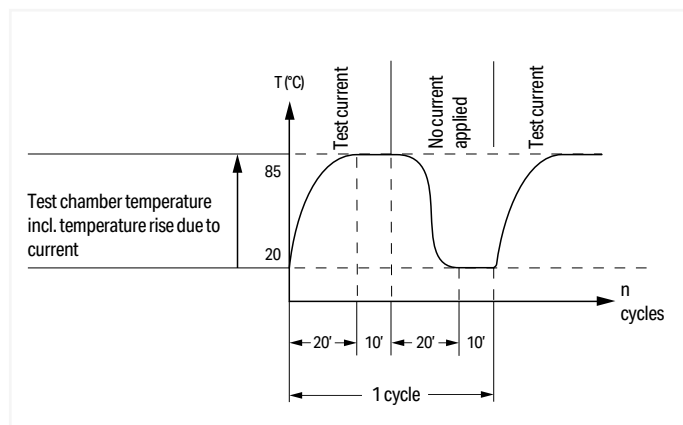

The rated current is applied to the test specimen during temperature rise and when the temperature has reached its maximum value; during the second half of the cycle, the current is zero. Voltage drop is measured every 24 cycles and must not exceed a maximum value or vary greatly. The voltage drop measured at the end of the 192nd cycle must not exceed 1.5 times the value measured after the 24th cycle. After the test, an inspection must show no changes that would impair further use of the product.

- Industrial Atmospheres per EN ISO 6988, IEC/EN 60068-2-42, IEC/EN 60068-2-60

Sulphur and its combustion products are particularly aggressive pollutants commonly found in industrial environments. A test procedure simulating such corrosive conditions consists of exposing a test specimen to water condensation in variable atmospheres containing sulphur dioxide.



A saturated atmosphere is first created in a climatic chamber by heating an aqueous sulphur dioxide solution. After less than half an hour, the test specimen is fully saturated by the condensing vapors and exposed to this atmosphere for eight hours.

After exposure to a humid atmosphere, the test specimen is subjected to dry and cooler conditions at room temperature for 16 hours. Depending on the test severity, the specimen is exposed to both these conditions several times. The gas-tightness of the clamping unit is verified by a voltage drop test.

In other test procedures, products are exposed to a dry corrosive gas atmosphere containing sulfide, nitrogen and sulfur oxides or chloride gas. These tests can be performed over a period of four to 21 days.

• Salt Spray Test per IEC/EN 60068-2-11; DNV GL, LR (Marine Applications)

This test is similar to the test performed in atmospheres with varying water condensation, except that instead of industrial atmospheres, salt mist conditions will be simulated in a heated test chamber (see picture).

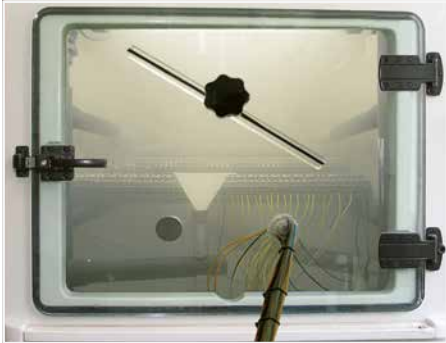

Depending on the test procedure being used, the test specimen is sprayed with salt mist for 16 hours up to 672 hours (4 weeks).

Salt spray tests are widely used, especially for marine approvals.

However, this test is performed differently than the test procedures described previously for general applications:

During a typical test, the test specimen is sprayed with a salt solution for two hours and is then stored for seven days in an atmosphere with a relative humidity between 90 and 95%. This procedure is repeated four times.

Voltage drop measurements are used as an evaluation criterion.

• Quick Change of Temperature per IEC/EN 60068-2-14

Without air-conditioning, distribution panels and terminal boxes are exposed to seasonal (and ever-changing) temperature extremes – especially on the open field side.

In process technology, for example, a terminal block is exposed to even quicker changes in temperature.

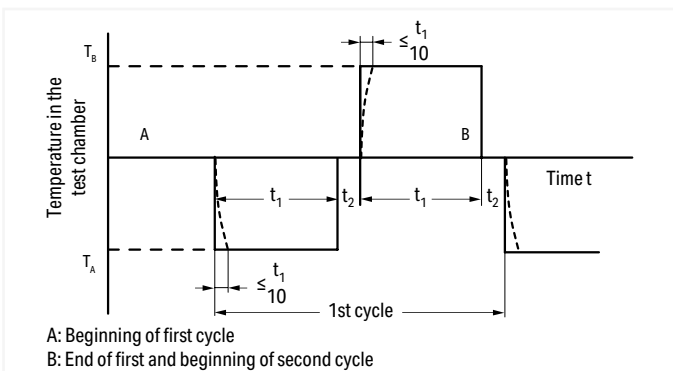

To simulate such conditions, the test specimen is exposed to repeated temperature changes, for example, between T_A -40°C (-104°F) and T_B +70°C (+158°F).

The dwell time t₁ depends on the thermal capacity of the test specimen and should be between maximum of 3 h and minimum of 10 min and the transition time t₂ ... 3 min, 20 ... 30 s or less than 10 s.

The mechanical and electrical properties of the product are checked at the end of the test.

• Damp Heat, Cyclic (12 + 12 Hour Cycle) per IEC/EN 60068-2-30, DNV GL, LR (Marine Applications)

This test determines the suitability of electrical equipment for use and storage under conditions of high relative humidity when combined with cyclic temperature changes and, in general, producing condensation on the surface of the specimen.

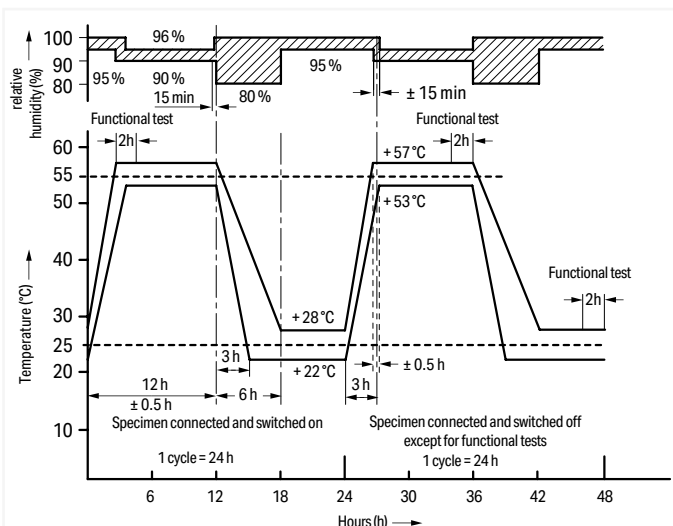

In addition to the salt spray tests, the damp heat test is also used for marine approvals.

For this test, the specimens are subjected to temperatures varying cyclically between +25°C (+77°F) and +55°C (+131°F) with a relative humidity of 95% (for tolerances see figure).

Functional tests are performed at defined times during the storage period.

The mechanical and electrical properties of the product are checked at the end of the test.

UL Specifications – Underwriters Laboratories, USA

WAGO's terminal blocks and connectors are tested by Underwriters Laboratories Inc. according to one or more of the relevant following UL standards:

- | | | |
|---|--------------------|---|
| • The 273 Series PUSH WIRE® Connectors for Junction Boxes or the 224 Series Lighting Connectors are splicing wire connectors and are certified per UL 486C. These stand-alone devices carry the UL Listing Mark ®. | UL 486C | Splicing wire connectors |
| • Rail-mount terminal blocks or modular terminal blocks (e.g., 280 Series, TOPJOB® S or 260 to 262 Series terminal blocks) are approved as non-stand-alone components per UL 1059 in connection with UL 486E. | UL 1059
UL 486E | Standard for terminal blocks
Equipment wiring terminals for use with aluminum and/or copper conductors |
| • The X-COM®-SYSTEM is approved as terminal blocks per UL 1059 standard in connection with UL 486E. It is therefore defined for field and factory wiring with at 300 V. | | |
| • It is also approved as connectors for use in data, signal, control and power applications per UL 1977 for factory wiring at 600 V (i.e., the clamping unit must be wired under controlled manufacturing conditions). | UL 1977 | Component connectors for use in data, signal, control and power applications |
| • Ex e II terminal blocks are approved to UL 60079-7. | UL 60079-7 | Electrical apparatus for explosive gas atmospheres – Part 7: Increased safety |
| • Ground terminal blocks are tested for grounding and bonding applications per UL 467. Components bearing the UR Recognition Mark ® are recognized product. Additionally, after being mounted in their special applications, these components are submitted to an end-product test according to the relevant device or equipment standard. | UL 467 | Grounding and bonding equipment |
| • Insulation materials are tested for flammability and performance per UL 94. | UL 94 | Tests for flammability of plastic materials for parts in devices and appliances |

Tests and Testing Procedures per UL Standards

All WAGO products meet requirements for the following tests:

- Pull-Out Test per UL 1059, UL 486E (Rail-Mount Terminal Blocks), UL 486C (Splicing Wire Connectors)

In this test, the connected conductors are subjected to the appropriate pull-out forces specified in the following table without jerking for a period of one minute. Different test arrangements are specified for rail-mount terminal blocks and splicing wire connectors.

Conductor Size AWG or kcmil		Pull-Out Force, Pounds (N)					
		UL 486E, Table 22				UL 486C, Table 20	
		Copper		Aluminum		Copper	
	(mm ²)						
30	(0.05)	0.5	(2.2)	-	-	1.5	(6.7)
28	(0.08)	1	(4.5)	-	-	2	(8.9)
26	(0.13)	2	(8.9)	-	-	3	(13.4)
24	(0.2)	3	(13.4)	-	-	5	(22.3)
22	(0.32)	4.5	(20)	-	-	8	(35.6)
20	(0.52)	6.75	(30)	-	-	10	(44.5)
18	(0.82)	6.75	(30)	-	-	10	(44.5)
16	(1.3)	9	(40)	-	-	15	(66.7)
14	(2.1)	11.5	(50)	-	-	25	(111)
12	(3.3)	13.5	(60)	10	(44)	35	(155)
10	(5.3)	18	(80)	10	(44)	40	(178)
8	(8.4)	20.5	(90)	10	(44)	45	(200)
6	(13.3)	21	(94)	28	(124)	50	(222)
4	(21.2)	30	(133)	36	(160)		
3	(26.7)	35	(156)	42	(187)		
2	(33.6)	42	(186)	50	(222)		
1	(42.4)	53	(236)	61	(271)		
1/0	(53.5)	64	(285)	72	(320)		
2/0	(67.4)	64	(285)	78	(347)		
3/0	(85.0)	79	(351)	97	(432)		
4/0	(107)	96	(427)	116	(516)		
250	(127)	96	(427)	116	(516)		
300	(156)	99	(441)	116	(516)		

Test Arrangement per UL 1059, UL 486E:

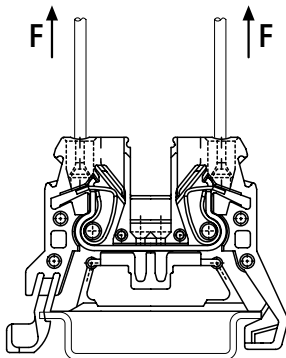

Test Arrangement per UL 486C:

During the test, the conductors must neither slip out of the clamping unit, nor break near the clamping unit.

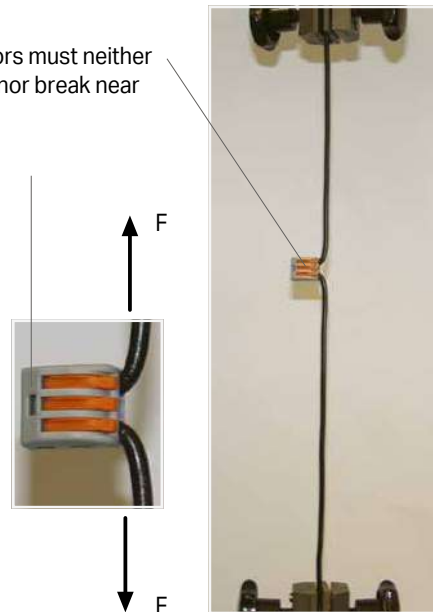

UL Specifications – Underwriters Laboratories, USA (continued)

Tests and Testing Procedures per UL Standards (continued)

• Heat Cycling Test per UL 1059, UL 486E

Test performed per:

UL 1059

Test performed with maximum rated cross section

Test current: 150% of maximum rated current

84 cycles of: 3 1/2 h ON / 1/2 h OFF

The temperature rise is measured after the first and the 84th cycle.

The temperature rise must not exceed 5°C (41°F) after the 84th cycle, compared to the temperature measured after the first cycle.

UL 486C (Splicing wire connectors)

UL 486E (Equipment wiring terminals)

Test performed with maximum rated cross section

Test current: Increased test current per
UL 486C, Table 6
UL 486E, Table 4

500 cycles of: 1 h ON / 1 h OFF
1 1/2 h ON / 1 1/2 h OFF
(from 4/0 AWG up to 400 kcmil per UL 486E)

The temperature rises at the terminal blocks and control conductors are measured and recorded after: 1, 25, 50, 75, 100, 125, 175, 225, 275, 350, 425 and 500 cycles.

The temperature rise must not exceed 125°C (257°F) and the stability factor "S" must not exceed ±10.

Conductor Size		Test Current for Copper Conductors in A								
		UL 486E, Table 4						UL 486C, Table 6		
AWG or kcmil	(mm ²)	Assigned Maximum Ampere Rating ^b	Static Heating ^{a,c,g}	Heat Cycling Temperature Rating ^a				Static Heating	Heat Cycling	
				75°C (167°F) ^{d,g}		90°C (194°F) ^{e,g}				
30	(0.05)	-	3		3.5		4	3	3.5	
28	(0.08)	-	3.5		4		5	3.5	4	
26	(0.13)	-	5.5		6		8	5.5	6	
24	(0.2)	-	7		8		10	7	8	
22	(0.32)	-	9		12		13	9	12	
20	(0.52)	-	12		16		17	12	16	
18	(0.82)	-	17		19		24	17	19	
16	(1.3)	-	18		20		31	18	20	
14	(2.1)	15	[20]	30	[22]	33	[27]	40	30	33
12	(3.3)	20	[25]	35	[28]	39	[40]	54	35	38
10	(5.3)	30	[40]	50	[45]	56	[60]	75	50	56
8	(8.4)	50		70		80		100	70	80
6	(13.3)	65		95		105		131	95	105
4	(21.2)	85		125		140		175		
3	(26.7)	100		145		165		205		
2	(33.6)	115		170		190		240		
1	(42.4)	130		195		220		275		
1/0	(53.5)	150		230		255		320		
2/0	(67.4)	175		265		300		370		
3/0	(85.0)	200		310		345		435		
4/0	(107)	230		360		405		505		
250	(127)	255		405		445		565		
300	(152)	285		445		500		625		

^a See Section 7.2, 8.2 and 9.2 (UL 486E)

^b Values are for 75°C (167°F), not more than 3 conductors in raceway or cable ampacities, National Electric Code, ANSI/NFPA 70.

^c Values are for 75°C (167°F) single conductors in free air ampacities, National Electric Code, ANSI/NFPA 70.

^d Values are approximately 112% of the static heating test currents.

^e Values for 8 AWG and larger conductors are approximately 140% of the static heating test currents.

^f See Section 9.2.4

^g Values in parentheses apply to connectors with assigned ampere ratings.

- Conditioning – Temperature-Rise Rest per UL 1059, UL 486C

Test performed per:

UL 1059 (Rail-mount terminal blocks)

UL 486C

(Splicing wire connectors)

Conditioning:

The clamping units are **pre-wired/pre-inserted nine times** using a conductor with maximum rated cross section. At the tenth time, a new conductor is connected.

After this, a static heating test is performed.

Static Heating Test:

Test current: Terminal block rated current

Test current: Increased test current (see Table 6)

Test duration: 30 days

Test duration: 30 days

Max. permissible temperature rise: 30°C (86°F)

Max. permissible temperature rise: 50°C (122°F)

- Grounding and Bonding Equipment per UL 467

When used in grounding and bonding equipment, e.g., terminal blocks, must withstand a short circuit test using the test currents and test durations as specified in Table 5.

In the following example, a 2 AWG (35 mm²) ground conductor terminal block (285-635) is tested for 6 seconds at 3900 A.

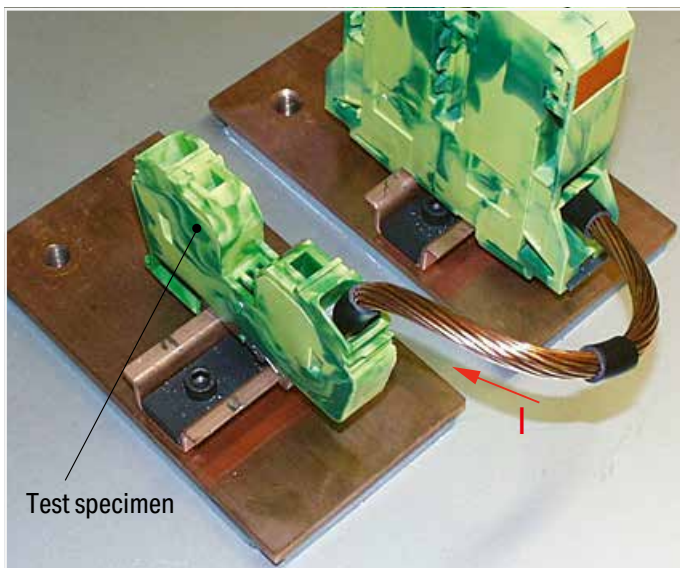

Table 5

Conductor Size Copper		Test Duration	Test Current
AWG	mm ²	s	A
14	(2.1)	4	300
12	(3.3)	4	470
10	(5.3)	4	750
8	(8.4)	4	1180
6	(13.3)	6	1530
4	(21.2)	6	2450
3	(26.7)	6	3100
2	(33.6)	6	3900
1	(42.4)	6	4900
1/0	(53.5)	9	5050
2/0	(67.4)	9	6400
3/0	(85.0)	9	8030
4/0	(107)	9	10100
250 kcmil	(127)	9	12000

After the test, the specimen must neither show evidence of cracking, breaking or melting, nor any changes in electrical properties.

UL Specifications – Underwriters Laboratories, USA (continued)

Tests and Testing Procedures per UL Standards (continued)

• Insulation Parameters per UL 1059

The table below shows the potential involved and the corresponding clearances and creepage distances required in different applications.

Table 8.1 – Minimum Acceptable Spacing for Terminal Blocks per UL 1059 Standard

Application:	Potential Involved in Volts	Spacing in inches (mm) between uninsulated live parts of opposite polarity, uninsulated live parts and uninsulated grounded parts other than the enclosure			
		Through Air		Over Surfaces	
A. Dead-front switchboards, panelboards, service equipment and similar applications	51 ... 150 151 ... 300 301 ... 600	1/2 3/4 1	(12.7) (19.1) (25.4)	3/4 1-1/4 2	(19.1) (31.8) (50.8)
B. Commercial appliances, including business equipment, electronic data processing equipment and similar applications	51 ... 150 151 ... 300 301 ... 600	1/16 ^a 3/32 ^a 3/8	(1.6) ^a (2.4) ^a (9.5)	1/16 ^a 3/32 ^a 1/2	(1.6) ^a (2.4) ^a (12.7)
C. Industrial, general	51 ... 150 151 ... 300 301 ... 600	1/8 ^a 1/4 3/8	(3.2) ^a (6.4) (9.5)	1/4 3/8 1/2	(6.4) (9.5) (12.7)
D. Industrial, devices having limited ratings ^b	51 ... 300 301 ... 600	1/16 ^a 3/16 ^a	(1.6) ^a (4.8) ^a	1/8 ^a 3/8	(3.2) ^a (9.5)
E. Terminal blocks rated 601 ... 1500 V ^c	601 ... 1000 1001 ... 1500	0.55 0.70	(14.0) (17.8)	0.85 1.20	(21.6) (30.5)

Notes:

- 1 A slot, groove, or similar, 0.013 inch (0.33 mm) wide or less in the contour of the insulating material is to be disregarded.
 - 2 Air space of 0.33 mm or less between a live part and an insulating surface is to be disregarded for the purpose of measuring over surface spacing.
- ^a The spacing between terminal blocks of opposite polarity and the spacing between a terminal block and a grounded dead metal part shall not be less than 1/4 inch (6.4 mm) if short-circuiting or grounding of such terminal blocks may result from protruding wire strands.
- ^b See Section 8.5 (UL 1059)
- The spacing values indicated in sub-paragraph D in Table 8.1 are applicable to a terminal block for use only in or with industrial control equipment where the load on any single circuit of the terminal block does not exceed 15 A at 51 ... 150 V, 10 A at 151 ... 300 V, 5 A at 301 ... 600 V or the maximum ampere rating, whichever is less.
- ^c Applies only to terminal blocks investigated to Part II of this standard. See Section 22.1 (UL 1059).

• Flammability Test per UL 94

This test provides an indication of the material's ability to extinguish a flame, once ignited. Several ratings can be applied, based on the rated of burning, time to extinguish, ability to resist dripping, and afterglow extinguishing time. Each material tested may receive several ratings, depending on the wall thickness.

UL 94 Rating Categories:

V2

- Specimen mounted vertically
- Burning stops within 30 seconds after the flame is removed
- Flaming drips allowed
- Afterglow extinguishes within max. 60 s

V1

- Specimen mounted vertically
- Burning stops within 30 seconds after the flame is removed
- No flaming drips allowed
- Afterglow extinguishes within max. 60 s

V0

- Specimen mounted vertically
- Burning stops within 10 seconds after the flame is removed
- No flaming drips allowed
- Afterglow extinguishes within max. 30 s

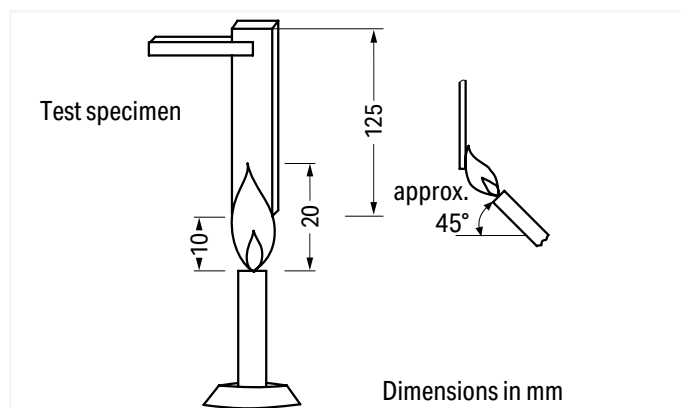

During the test, a 3/4 inch (20 ± 1 mm) flame is applied for two 10-second intervals to the specified bar specimen held vertically.

"Alu-Plus" Contact Paste

Terminating aluminum conductors

Terminating Aluminum Conductors

WAGO spring clamp terminal blocks are suitable for solid aluminum conductors ① up to 4 mm²/12 AWG if WAGO "Alu-Plus" Contact Paste is used for termination.

"Alu-Plus" Contact Paste Advantages:

- Automatically destroys the oxide film during clamping.
- Prevents fresh oxidation at the clamping point.
- Prevents electrolytic corrosion between aluminum and copper conductors (in the same terminal block).
- Provides long-term protection against corrosion.

For spring clamp connections with PUSH WIRE® connection technology, WAGO recommends that the aluminum conductor first be cleaned and then immediately inserted into the clamping unit filled with "Alu-Plus" contact paste

Using terminal blocks with CAGE CLAMP® Spring Pressure Connection Technology, aluminum conductors must first be cleaned with a blade and then immediately be inserted into the clamping units filled with "Alu-Plus" Contact Paste.

It is also possible to apply WAGO "Alu-Plus" additionally on the whole surface of the aluminum conductor before termination.

Please note that the nominal currents must be adapted to the reduced conductivity of the aluminum conductors:

2.5 mm² (14 AWG) = 16 A
4 mm² (12 AWG) = 22 A

WAGO "Alu-Plus" in the syringe offers a higher degree of reliability and cleanliness when terminating solid aluminum conductors. Filling is quickly performed on selected WAGO connectors and terminal blocks (see pictures).

① Aluminum conductors per IEC 61545 standard, Class B, "Alloy 1370" with 90 ... 180 N/mm² tensile strength and 1 ... 4% elongation
Standard values: 90 ... 180 MPa tensile strength, 1 ... 4% elongation (per EN 615.4.1)



WAGO Lighting Connectors

Push nozzle of the "Alu-Plus" syringe first into the circular entry and then into the square conductor entry hole of the WAGO Lighting Connector.



Press plunger down until the "Alu-Plus" has filled both entry holes.

Note: Not suitable for higher temperature applications!



WAGO Rail-Mount Terminal Blocks (up to 4 mm²/12 AWG)

For each conductor entry: Insert nozzle of the "Alu-Plus" syringe in every open conductor entry hole (one after the other).



Press plunger down until "Alu-Plus" has filled all conductor entry holes.

Material Specifications

Insulation materials

WAGO primarily uses polyamide (PA 66 and PA 46) for housing current-conducting parts, as well as polyphthalamide (PPA) and polycarbonate (PC) for insulation material (see table). For more than 50 years, these materials have proven themselves in WAGO products and all are approved by certified, third-party agencies. All listed halogen-free and flame-retardant polymer materials do not contain any heavy metals, silicone, asbestos, or formaldehyde as formulation components.

Table: Standard Insulation Materials

Material	PA 66	PA 66 GF	PPA GF	PA 46	PC	PC
Flammability UL 94 flammability test ratings	V0	V0	V0	V2	V2	V0
Oxygen Index (OI) per EN ISO 4589-2	> 32 %	> 33 %	> 37 %	> 27 %	> 26 %	> 35 %
Glow-wire test per IEC 60695-2-12 GWFI* IEC 60695-2-13 GWIT*	850°C 775°C	850°C 775°C	850°C 775°C	750°C 725°C	800°C 850°C	960°C 850°C
Comparative Tracking Index (CTI) per IEC 60112	600 V	600 V	600 V	375 V	225 V	225 V
Temperature of the ball indentation hardness test per IEC 60695-10-2	≥ 125 °C	≥ 175 °C	≥ 225 °C	n.s.**	≥ 125 °C	≥ 125 °C
RTI impact per UL 746B	105°C	100°C	115°C	115°C	125°C	120°C
Heat deflection temperature (HDT/B) per ISO 75 (bending stress A*: 1.8 MPa; B: 0.45 MPa)	215°C	235°C	285°C	280°C	130°C (1.8 MPa)	130°C (1.8 MPa)
Surface resistivity per IEC 60093	10 ¹² Ω	10 ¹² Ω	10 ¹⁵ Ω	10 ¹³ Ω	10 ¹⁵ Ω	10 ¹⁵ Ω
Specific contact resistance per IEC 60093	10 ¹⁵ Ω/cm	10 ¹⁵ Ω/cm	10 ¹³ Ω/cm	10 ¹³ Ω/cm	10 ¹¹ Ω/cm	10 ¹³ Ω/cm
Dielectric strength per IEC 60243-1	30 kV/mm	40 kV/mm	25 kV/mm	25 kV/mm	25 kV/mm	29 kV/mm

*Value depends on wall thickness, EN 60335 compliance upon request; **n. s. = not specified

General Environmental Requirements for WAGO Electrical Interconnection Products

WAGO Electrical Interconnection Products are designed for worldwide applications.

To properly commission products, the following environmental requirements must be observed during storage, transportation and operation.

Table 1: General Environmental Requirements for Storage, Transportation and Operation*

Environmental requirements during	Value range
Operation	-35 °C ... +60 °C
Storage and transportation	-40 °C ... +60 °C
Relative humidity (storage and transportation)	20 % ... 95 % (non-condensing, no dew)

*These requirements apply to open and packaged products unless otherwise specified on the product at www.wago.com or on the catalog page.

Polyamide (PA 66)

WAGO uses modified, halogen-free, flame-retardant polyamides.

These materials do not corrode, are difficult to ignite and feature self-extinguishing properties (V0 rating per UL 94).

Adhering to UL 746C, the polyamides used at WAGO have a continuous operating temperature of 105°C (221°F) based on the relative temperature index with impact load (RTIimp). This ensures that the necessary electrical and mechanical insulating properties are maintained at a sufficiently guaranteed level over a long period of time.

The short-term upper temperature limit is 200°C (392°F).

In lower temperature ranges, it has been determined that no damage to the insulation material occurs during usage down to -35°C (-31°F). After installation and wiring, WAGO products can even be used at temperatures down to -60°C (-76°F).

Environmental humidity (up to 2.5% in a standard atmosphere) is absorbed, providing the polyamides with optimum elasticity, strength and durability.

In practical use, basic stabilization of WAGO's polyamides has been proven over many years to be sufficient to prevent damage caused by ozone or UV radiation exposure in intended applications.

Polyamides have excellent resilience against the most demanding climates and have proven themselves in tropical applications worldwide. Insulation parts made of polyamide are resistant to insects. The material does not provide oxygen or other biogenic elements to microorganisms.

The presence of anaerobic earth bacteria, mold, fungus and enzymes does not degrade the material.

Polyamides are resistant to most fuels, greases, and oils, as well as the most commonly used cleaners, such as alcohol, Freon, Frigen, and carbon tetrachloride. Acid resistance depends on the acid type and concentration, as well as the exposure time.

The use of insulation materials during in-house production at WAGO only occurs after acceptance of factory test certificates and specified material tests.

Glass Fiber-Reinforced Polyamide (PA 66 GF)

WAGO uses glass-fiber-reinforced polyamides for components with increased mechanical demands, such as levers, push-buttons or housings exposed to high stress, because they have significantly better mechanical characteristic properties than non-reinforced polyamides.

In general, materials are used that have excellent tracking resistance, flammability ratings and high temperature resistance.

More data can be found in the table.

Polyphthalamide (PPA GF)

Glass-fiber-reinforced, high-performance polyamides are ideal for high-temperature applications, due to the material's high level of thermal dimensional stability, its low dependence on ambient conditions and its excellent strength properties. The material's outstanding tracking resistance permits short creepage distances to be incorporated into miniature components. Fire protection equipment enables classification in flammability class V0 per UL 94 – even for extremely thin walls. PPA GF absorbs minute amounts of moisture from the atmosphere making it ideal for reflow soldering applications and for thin-walled, dimensionally stable components.

More data can be found in the table.

Polyamide (PA 46)

In comparison with PA 66, PA 46 has substantially higher dimensional stability under heat. The relative temperature index with impact load (RTIimp) is 115°C (239°F) for PA 4.6.

The permissible short-term temperature for the type used by WAGO is 280°C (536°F).

More data can be found in the table.

Polycarbonate (PC)

Polycarbonate has excellent dimensional stability under heat. The electrical and mechanical properties remain intact at extremely high temperatures up to approximately 120°C (248°F) per UL Yellow Card. Its excellent electrical insulating properties and dimensional stability are virtually independent of environmental conditions, such as humidity and temperature. Highly precise components can be created due to the low shrinkage of the material during injection molding. Polycarbonate has excellent weather resistance and is also highly resistant to high energy radiation. If the PC is not colored, then the components are glass-clear.

Thanks to its desirable properties (e.g., dimensional stability, heat resistance, non-flammability, durability and transparency), PC is a proven and widely used material in the electrical industry.

Depending on the demands placed on the finished product, WAGO uses polycarbonates that carry flammability classifications V2 and V0 per UL 94.

Medium-viscosity PC is used that features excellent chemical resistance.

Material Specifications

Contact Materials

Hard and extra-hard electrolytic copper (ECu), as well as extra-hard copper alloys are the standard materials used for the current-carrying parts of all WAGO products.

These materials combine excellent conductivity and good chemical resistance without the risk of stress-induced cracking.

Contact Materials

The special tin layer, which is the standard layer for all current-carrying parts in WAGO products, ensures perfect long-term protection against corrosive substances. Furthermore, these layers provide a gas-tight contact that ensures a durable transition resistance.

At the clamping unit, the conductor is embedded into the soft tin layer via high contact pressure. This protects the contact area against corrosion.

The thick tin layer also ensures good solderability of both PCB terminal block and connector solder pins.

Clamping Spring Material

Every WAGO clamping spring is made of high-quality, accurately tested austenitic chrome nickel steel (CrNi) with high tensile strength, which boasts proven corrosion resistance through long-term usage.

It is resistant to sea spray, city pollutants and industrial emissions (e.g., sulfur dioxide, hydrogen sulfide).

At room temperatures of approximately 20°C (68°F), the material is resistant to salt solutions up to 30% and dilute phosphoric acids up to 30%.

Even after decades of use, no galvanic corrosion between the chrome nickel spring steel (in connection with the contact materials used by WAGO) and the connected copper conductors has been detected.

The relaxation of the material as a function of time and surrounding temperatures up to 105°C (221°F) can be ignored. Samples loaded with 500 N/mm² at a temperature of 250°C (482°F) showed a relaxation of only 1.5%.

In certain product lines, the clamping springs are thermally treated at temperatures between 350°C (662°F) and 420°C (788°F) after production.

This treatment reduces internal stress due to the material's mechanical deformation, which may result in a slight brown discoloration of the spring surface.

WAGO only accepts deliveries of chrome nickel spring steel against certificates of conformity and after select material tests have been performed.

General Technical Information on Electrical Equipment Used in Hazardous Areas

The formation of an explosive atmosphere is required for the existence of a potentially explosive hazard. Such an atmosphere can be produced at any location where flammable gases or liquids are manufactured, processed, transported and/or stored.

Such hazardous areas can be found in a wide range of industries, including chemical plants, refineries, power plants, paint production facilities, painting shops, filling stations, vehicles, sewage treatment plants, airports, grain mills or harbor facilities.

THE FOLLOWING APPLIES AS A GUIDELINE FOR THE UNDERLYING PRINCIPLE FOR EXPLOSION PROTECTION:

General Requirements

The European EN 60079-0 Standard – VDE 0170-1 Classification – contains general requirements for the design and testing of electrical equipment to be used in hazardous areas.

This ensures this equipment does not cause an explosion in the surrounding atmosphere. EN 60079-0 is supplemented or revised by the European standards indicated on the right which refer to the specifically standardized types of protection.

Electrical Equipment

Electrical equipment includes all items used in whole or in part with electricity. This includes items for generation, transport, distribution, storage, measurement, control, conversion and consumption of electrical power, as well as telecommunications.

Ex Components

Ex components are elements of electrical equipment for hazardous areas that are marked with the "U" letter. These components must not be used on their own in such areas and require an additional certificate when used in such areas when installed in the electrical equipment.

Ignition Protection Categories

Only explosion-proof (protected) equipment must be used in areas in which an explosive atmosphere may still be expected despite the implementation of prevention measures. Explosion-protected electrical equipment can have various types of protection in accordance with the EN 60079 standard requirements.

Protection used by the manufacturer essentially depends on the type and function of the apparatus. From a safety point of view, all standardized types of protection should be viewed as equal.

The ignition protection category "n" exclusively describes the use of explosion-protected electrical components in Zone 2. This zone includes areas in which hazardous, potentially explosive atmospheres are likely to occur rarely or short-term. This represents a transition between Zone 1, in which explosion protection is required, and the safe area in which, for example, welding may be performed at any time.

Regulations covering these electrical components are being prepared worldwide. Organizations such as KEMA in the Netherlands, or PTB in Germany certify that the devices meet the requirements of the EN 60079-15 standard.

Ignition protection category "n" also requires that electrical equipment be provided with additional ID markings as follows:

- nA – non-sparking
- nC – enclosed-break, hermetically sealed, non-incendive, sealed
- nR – restricted-breathing

The table on the opposite page shows an overview of the standardized ignition protection categories and describes their basic principle, as well as typical applications.

General Technical Information on Electrical Equipment Used in Hazardous Areas Continued

Ignition Protection Categories			
Symbol	Standard	Explanation	Application Area
"o"	IEC 60079-6 EN 60079-6	Equipment protection by oil immersion: Electrical equipment or parts of such equipment are immersed in oil.	Zones 1 + 2
"p"	IEC 60079-2 EN 60079-2	Equipment protection by pressurized enclosure: The ingress of the external (explosive) atmosphere into the electrical equipment housing is prevented by maintaining a protective gas internally at a pressure above that of the external atmosphere.	Zones 1 + 2
"q"	IEC 60079-5 EN 60079-5	Equipment protection by sand filling: Filling the electrical equipment housing with fine grain sand prevents the ignition of a surrounding explosive atmosphere by an electric arc generated in the housing.	Zones 1 + 2
"d"	IEC 60079-1 EN 60079-1	Equipment protection by flameproof enclosures: The parts that could ignite an explosive atmosphere are encapsulated in a housing, which will withstand the explosion pressure within the housing.	Zones 1 + 2
"eb" "ec"	IEC 60079-7 EN 60079-7	Equipment protection by increased safety: Additional measures applied to achieve increased security against the possibility of excessive temperatures and the occurrence of arcs or sparks.	Zones 1 + 2
"i"	IEC 60079-11 EN 60079-11	Equipment protection by intrinsic safety: Power circuit in which no sparks or thermal effects can occur and cause the ignition of a certain explosive atmosphere.	Zones 1 + 2 following special testing Zone 0
"nA" "nC" "nR"	IEC 60079-15 EN 60079-15	Equipment protection by type of protection "n": Electrical equipment of group II for use in areas in which an explosive mixture of gas, vapor or mist is unlikely to occur during normal operation and, if it does, will be for a short period.	Zone 2:
"m"	IEC 60079-18 EN 60079-18	Equipment protection by cast encapsulation: Dangerous electrical equipment is embedded in a cast mass. This corresponds approximately to the known special Ex s protection type.	Zones 1 + 2
	IEC 60079-25 EN 60079-25	Intrinsically safe electrical systems "i": Assembly of interconnected electrical equipment in which the circuits intended for use, as a whole or in part, in hazardous environments are intrinsically safe. It is documented accordingly in the system description	Zones 1 + 2 following special testing Zone 0

Hazardous Areas

Hazardous areas are zones in which the atmosphere may become explosive. An explosive atmosphere is a mixture of flammable substances in the form of gases, vapors or mixtures with air under atmospheric conditions in critically mixed ratios such that excessive high temperature, arcs or sparks may cause an explosion.

EN 60079-10-1/EN 60079-10-2 and all other well-known standards rank hazardous areas according to the likelihood of the occurrence of an explosive atmosphere into the following zones:

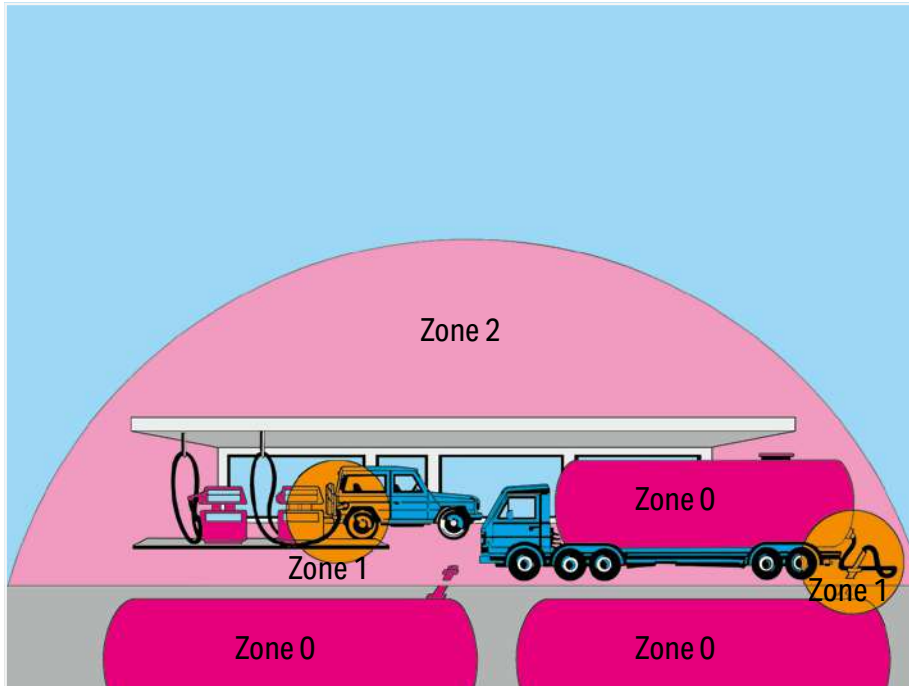

Hazardous areas due to explosive gases, vapors and mists:

Zone 0

Area in which an explosive gas atmosphere is present continuously, for long periods or frequently.

Zone 1

Area in which an explosive gas atmosphere is likely to occur periodically or occasionally during normal operation.

Zone 2:

Area in which an explosive gas atmosphere is unlikely to occur during normal operation; if it does occur, then it is temporarily.

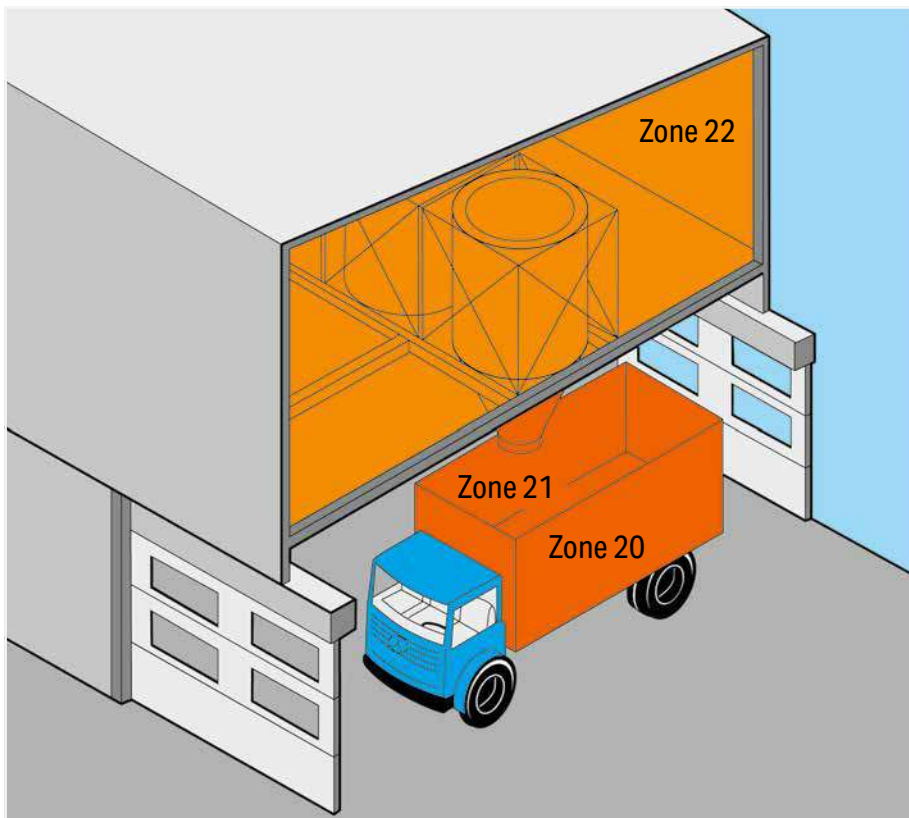

Hazardous areas due to explosive dust/air mixtures:

Zone 20

Area in which an explosive dust atmosphere due to dust/air mixtures is present continuously, for long periods or frequently.

Zone 21

Area in which an explosive dust atmosphere due to dust/air mixtures is likely to occur occasionally during normal operation.

Zone 22

Area in which an explosive dust atmosphere due to flammable dust/air mixtures is unlikely to occur during normal operation; but if it occurs, then only for a short period of time.

General Technical Information on Electrical Equipment Used in Hazardous Areas

Continued

EN 60079-0 also classifies electrical equipment for use in hazardous areas into two groups:

Group I:

Electrical equipment for mines susceptible to firedamp

Group II:

Electrical equipment for hazardous areas, except for mines susceptible to firedamp.

As this broad application range encompasses a large number of potentially flammable gases, Group II is broken down into sub-groups IIA, IIB and IIC.

This breakdown is based on different gases/materials exhibiting differing ignition power levels as parameters. Therefore, representative gases have been allocated to these three sub-groups:

- IIA – Propane
- IIB – Ethylene
- IIC – Hydrogen

WAGO's terminal blocks can be used both in Group I and Group II.

This information is given under Item 12 in the EU Prototype Test Certificates, based on which the terminal blocks have been approved for Group I and Group II.

Temperature Class	Maximum Surface Temperature (°C)
T1	450
T2	300
T3	200
T4	135
T5	100
T6	85

Depending on the maximum surface temperature, electrical equipment in Group II are classified in temperature categories T1 to T6 for all protection types. The surrounding air temperature, which must be accounted for in dimensioning, is defined as 40°C/104°F (deviations are acceptable under some conditions).

Terminal blocks for "e" (increased safety) protection type are generally assigned to temperature category T 6. When rail-mount terminal blocks are used in equipment of temperature categories T1 to T5, ensure that the highest temperature on the insulating parts does not exceed 85°C (185°F). The highest measured surface temperature rise must not exceed 40 K.

Thermal resistance of the insulation material must be at least 20°C (68°F) greater than the highest operating temperature. Low temperature stability is considered to be sufficient when the insulation material can withstand 24-hour storage at a temperature of -60°C (-76°F) without nullifying the type of protection.

Special Requirements "Increased Safety Ex e"

The European EN 60079-7 Standard – VDE 0170-6 Classification – or the EN IEC 60079-7 Standard in the UK contain special requirements for the design and testing of electrical equipment with "e" (increased safety) protection type for hazardous areas. This standard is a supplement to EN 60079-0 or EN IEC 60079-0 and applies to equipment or parts thereof that neither generate sparks or arcing under normal operating conditions, nor exhibit hazardous temperatures. This standard describes special measures, which have to be observed to obtain a safety degree according to the "e" (increased safety) protection type.

Ex components such as rail-mount terminal blocks are covered by Section 4.2 "Terminal Blocks for External Conductors":

- The connectors must be installed in an enclosure meeting the requirements of a recognized protection type per EN 60079-0 and EN IEC 60079-0, Section 1 or EN 60079-31.
- When installing the terminal blocks in an enclosure of protection type "e" (increased safety) per EN 60079-7 or the EN IEC 60079-7 Standard in the UK, the clearances and creepage distances of Table 2 must be observed. When using accessories, the installation instructions of the manufacturer must be observed.
- The connectors meet the requirements of the Group I Category M2 (I M 2) components.
- Please also observe the "Schedule of Limitations" in the individual certificates.
- The use of this component requires a new assessment by a notified certification agency.
- Please also observe the "Schedule of Limitations" in the individual certificates.

Minimum Ignition Power of Typical Gases:

Explosion Group	I	IIA	IIB	IIC
Gas	Methane	Propane	Ethylene	Hydrogen
Ignition Power	280	250	82	16

The following are the most important design requirements for terminal blocks for external supply conductors to electrical equipment: These must:

- be sufficiently large to permit reliable connection of external supply conductors with cross section of at least the size required by the nominal current of the equipment
- be protected against self-loosening and designed such that the supply conductors cannot slip out of their clamping units
- be designed such that adequate contact pressure is ensured without damaging the conductors
- be designed such that their contact pres-

sure does not change with temperature cycling

- be equipped with a spring connecting link for the connection of stranded conductors
- be designed so as to allow secure connection of smaller conductors for terminal blocks up to 4 mm² (12 AWG).

Classification of insulation materials according to their tracking resistance is based on their Comparative Tracking Index (CTI) and is defined in Table 1 as follows:

This classification applies to insulating parts without ribs or grooves.

If the insulating parts have ribs or grooves sufficiently large to be considered, the minimum creepage distances must be set according to values for the insulation materials in the next-higher level (e.g., Group I, instead of Group II).

Accounting for the surrounding air temperature of 40°C (104°F) specified for electrical equipment, the current-carrying capacity of rubber-insulated conductors is reduced to 82%, based on DIN VDE 0298-4:2013-06, Table 12 and to 87% for PVC-insulated conductors for the current-carrying capacity defined for 30°C (86°F) in accordance with DIN VDE 0298-4:2013-06, Item 4.3.3.

Conductor Types and Conductor Preparation

In accordance with EN 60079-14/DIN VDE 0165-1, the ends of stranded and fine-stranded conductors must be protected against splaying (e.g., via cable lugs or ferrules) or by the type of terminal blocks used. Soldering alone is not sufficient.

According to EN 60069-7/DIN VDE 0170-6, connecting electrical equipment to terminal blocks having an "e" (increased safety) protection type must not lead to a reduction of the clearances and creepage distances.

Based on experience through the application of terminal blocks in aggressive atmospheres in the chemical industry, WAGO recommends gas-tight tinned copper ferrules or tinned copper pin terminals when connecting fine-stranded conductors to terminal blocks in

Table 1– Tracking Resistance for Insulation Materials

Material Group	Comparative Tracking Index
I	600 ≤ CTI
II	400 ≤ CTI < 600
III a	175 ≤ CTI < 400
III b	100 ≤ CTI < 175

corrosive atmospheres.

Table 2– Minimum Creepage Distances/Clearances and Isolations

Voltage (see ^a and ^b) RMS Value for AC or DC Voltage V	Minimum Creepage Distance mm								Minimum Clearance and Isolations mm		
	Material Group								Clearance mm	Distance under Coat- ing ^d	
	I		II		III a		III b				
	"eb"	"ec"	"eb"	"ec"	"eb"	"ec"	"eb"	"ec"	"eb"	"ec"	"ec"
≤ 10 (see ^c)	1.6	1	1.6	1	1.6	1	-	1	1.6	0.4	0.3
≤ 12.5	1.6	1.05	1.6	1.05	1.6	1.05	-	1.05	1.6	0.4	0.3
≤ 16	1.6	1.1	1.6	1.1	1.6	1.1	-	1.1	1.6	0.8	0.3
≤ 20	1.6	1.2	1.6	1.2	1.6	1.2	-	1.2	1.6	0.8	0.3
≤ 25	1.7	1.25	1.7	1.25	1.7	1.25	-	1.25	1.7	0.8	0.3
≤ 32	1.8	1.3	1.8	1.3	1.8	1.3	-	1.3	1.8	0.8	0.3
≤ 40	1.9	1.4	2.4	1.6	3	1.8	-	1.8	1.9	0.8	0.6
≤ 50	2.1	1.5	2.6	1.7	3.4	1.9	-	1.9	2.1	0.8	0.6
≤ 63	2.1	1.6	2.6	1.8	3.4	2	-	2	2.1	0.8	0.6
≤ 80	2.2	1.7	2.8	1.9	3.6	2.1	-	2.1	2.2	0.8	0.8
≤ 100	2.4	1.8	3	2	3.8	2.2	-	2.2	2.4	0.8	0.8
≤ 125	2.5	1.9	3.2	2.1	4	2.4	-	2.4	2.5	1	0.8
≤ 160	3.2	2	4	2.2	5	2.5	-	2.5	3.2	1.5	1.1
≤ 200	4	2.5	5	2.8	6.3	3.2	-	3.2	4	2	1.7
≤ 250	5	3.2	6.3	3.6	8	4	-	4	5	2.5	1.7
≤ 320	6.3	4	8	4.5	10	5	-	5	6	3	2.4
≤ 400	8	5	10	5.6	12.5	6.3	-	6.3	6	4	2.4
≤ 500	10	6.3	12.5	7.1	16	8	-	8	8	5	2.4
≤ 630	12	8	16	9	20	10	-	10	10	5.5	2.9
≤ 800	16	10	20	11	25	12.5	-	-	12	7	4
≤ 1000	20	11	25	11	32	13	-	-	14	8	5.8
≤ 1250	22	12	26	12	32	15	-	-	18	10	-
≤ 1600	23	13	27	13	32	17	-	-	20	12	-
≤ 2000	25	14	28	14	32	20	-	-	23	14	-
≤ 2500	32	18	36	18	40	25	-	-	29	18	-
≤ 3200	40	22	45	22	50	32	-	-	36	22	-
≤ 4000	50	28	56	28	63	40	-	-	44	28	-
≤ 5000	63	36	71	36	80	50	-	-	50	36	-
≤ 6300	80	45	90	45	100	63	-	-	60	45	-
≤ 8000	100	56	110	56	125	80	-	-	80	56	-
≤ 10000	125	71	140	71	160	100	-	-	100	70	-
≤ 12500	-	90	-	90	-	125	-	-	-	89	-
≤ 13640	-	98	-	98	-	138	-	-	-	97	-

^{a)} When determining the required values for creepage distances and clearances, the working voltage may be 1.1 times higher than the value in the table.

NOTE: The factor of 1.1 takes into account that in many places in a circuit the working voltage is equal to the rated voltage and that a number of rated voltages are used, which are covered by a factor of 1.1.

^{b)} The specified values for creepage distances and clearances already take into account a 10% tolerance for the highest supply voltage. Therefore, further considerations on the voltage fluctuations are unnecessary for determining which voltage value from the table should be used.

^{c)} CTI values are not applicable for voltages of 10 V or less. Materials that do not meet the requirements of material group III a can be used.

^{d)} The specified distances under consideration apply to printed circuit boards in protection level "ec" after 4.5.

It is expressly prohibited to use insulating parts for transferring contact forces. Terminal blocks with sharp edges which could damage supply lines and those types that can be rotated, turned or permanently deformed when fixed in place are not permitted for use. Terminal blocks for internal connections in electrical equipment must not be subjected to excessive mechanical stress. These items must fulfill the requirements for terminal blocks used for external supply conductors.

Clearances between conductive parts having different potentials must be at least 3 mm for external connections, as specified in Table 2. The value of the creepage distances depends on the working voltage, surface geometry of the insulating parts and tracking resistance of the insulation material.

Grooves on the surface may only be considered if they are at least 2.5 mm deep and wide; ribs on the surface only if their height is at least 2.5 mm and their width corresponds to the mechanical strength of the material, however not smaller than 1 mm.

General Technical Information on Electrical Equipment Used in Hazardous Areas

Continued

Approvals

Terminal blocks may be used in Zones 1 and 2, provided that the terminal blocks are accommodated in an enclosure that has a minimum IP54 protection and an Ex e certification.

Terminal blocks are considered to be Ex components because they are a part of the equipment. Part certificates provided by Ex Certification Agencies serve as a basis for issuing the complete conformity declaration for the unit.

An EC-type examination certificate is issued in accordance with the 2014/34/EU ATEX Directive.

In addition, an IEXEx Certificate may also be obtained from an appropriate, recognized certification agency in accordance with the IECEx Certification Agreement that is accepted throughout Europe and also in countries such as Canada, China and Australia.

These certificates can also be viewed at: www.iecex.com.

Terminal block marking per 2014/34/EU ATEX Directive:

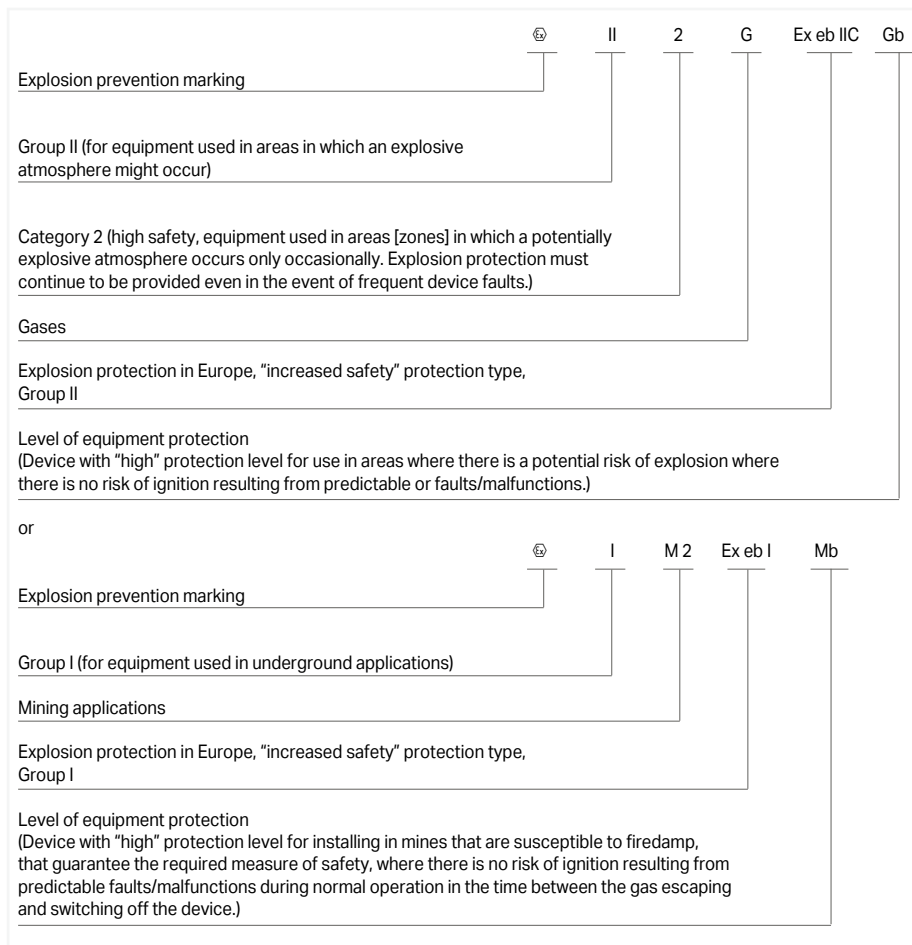

Example of marking (rear):

Series

Manufacturer's name

Nominal isolation voltage

Protection type

Part certification no.

Nominal cross section

(solid, stranded or fine-stranded conductors)

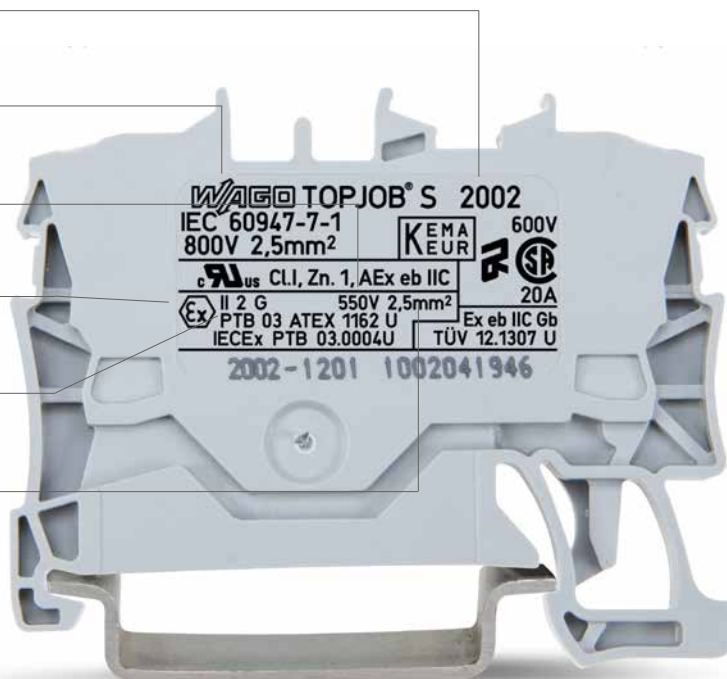

The embossed details on the terminal blocks show the manufacturer's name, the series number, the approval number, the approval data and the name of the testing authority. The type of protection Ex eb IIC Gb shown on the label or on the smallest packaging unit.

Terminal blocks for Class I, Zone 1, Ex eb IIC hazardous locations can be approved for Ex applications per UL 60079-7 standard. As a result of international harmonization efforts, the UL certificate can be issued on the basis of EN 60079-0 or EN 60079-7 standards, provided that the terminal blocks have also been approved per UL 1059 (ordinary location).

If desired by the applicant, terminal blocks can simultaneously be approved in accordance with the Canadian Standards CAN/CSA-C22.2 No. 60079-0 and CAN/CSA C22.2 No. 60079-7 and released for use in Canada. The terminal blocks are marked with  Cl. I, Zn. 1, AEx eb IIC.

EU-type examination certificates have been granted to all WAGO terminal blocks listed in this catalog. WAGO terminal blocks approved for use in Ex eb IIC areas are manufactured of flame-resistant, self-extinguishing Polyamide 66. The same applies to the terminal blocks used in non-hazardous areas. Tracking resistance with a CTI value of 600 as per IEC 60112 and a constant operating temperature of 105°C (22°F) in accordance with IEC 60216-1 and -2 are provided. Factory part quality tests are performed on all CAGE CLAMP® rail-mount terminal blocks with Ex eb IIC approval to monitor and ensure the quality features described above.



IECEx Certificate of Conformity

INTERNATIONAL ELECTROTECHNICAL COMMISSION
IEC Certification Scheme for Explosive Atmospheres
for rules and details of the IECEx Scheme, visit www.iecex.com

Ex COMPONENT CERTIFICATE

Certificate No.:	IECEx PTB 18.0012U	Issue No. 0	Certificate history: <small>Issue No. 0 (2018-08-30)</small>
Status:	Current	Page 1 of 3	
Date of Issue:	2018-08-30		
Applicant:	WAGO Kontakttechnik GmbH & Co. KG Hansastraße 27 32423 Minden Germany		
Ex Component:	WAGO type PE & Through terminal blocks type TOPJOB S 2202-**** and TOPJOB S 2202-****		

This component is NOT intended to be used alone and requires additional consideration when incorporated into other equipment or systems for use in explosive atmospheres (refer to IEC 60079-0).

Type of Protection: **Increased Safety "ib"**
 Marking: Ex eb IIC Gb and Ex eb I Mb

Approved for issue on behalf of the IECEx Certification Body:

Position:

Signature: *(for printed version)*

Date:

Dipl.-Phys. U. Völkel

Department "Explosion Protection in Energy Technology"



31.8.18

1. This certificate and schedule may only be reproduced in full.
 2. This certificate is not transferable and remains the property of the issuing body.
 3. The Status and authenticity of this certificate may be verified by visiting the Official IECEx Website.

Certificate issued by:

Physikalisch-Technische Bundesanstalt (PTB)
Bundesallee 100
38116 Braunschweig
Germany





Physikalisch-Technische Bundesanstalt
Braunschweig und Berlin
Nationales Metrologieinstitut





EU-Baumusterprüfbescheinigung

- (1)
- (2) Komponente zur bestimmungsgemäßen Verwendung in explosionsgefährdeten Bereichen
Richtlinie 2014/34/EU
- (3) EU-Baumusterprüfbescheinigungsnummer
PTB 18 ATEX 1005 U **Ausgabe: 0**
- (4) Produkt: Durchgangsreihenklemmen Typ TOPJOB S 2202-****
Schutzleiterreihenklemmen Typ TOPJOB S 2202-****
- (5) Hersteller: WAGO Kontakttechnik GmbH & Co. KG
- (6) Anschrift: Hansastraße 27, 32423 Minden, Deutschland
- (7) Die Bauart dieses Produkts sowie die verschiedenen zulässigen Ausführungen sind in der Anlage und den darin aufgeführten Unterlagen zu dieser Baumusterprüfbescheinigung festgelegt.
- (8) Die Physikalisch-Technische Bundesanstalt, notifizierte Stelle Nr. 0102 gemäß Artikel 17 der Richtlinie 2014/34/EU des Europäischen Parlaments und des Rates vom 26. Februar 2014, bescheinigt, dass dieses Produkt die grundlegenden Sicherheits- und Gesundheitsanforderungen für die Konzeption und den Bau von Produkten zur bestimmungsgemäßen Verwendung in explosionsgefährdeten Bereichen gemäß Anhang II der Richtlinie erfüllt.
Die Ergebnisse der Prüfung sind in dem vertraulichen Prüfbericht PTB Ex 18-17171 festgehalten.
- (9) Die grundlegenden Sicherheits- und Gesundheitsanforderungen werden erfüllt durch Übereinstimmung mit
IEC 60079-0:2017, EN 60079-7:2015
- (10) Das Zeichen "U" hinter der Zertifikatsnummer gibt an, dass dieses Zertifikat nicht mit einem für ein Gerät oder Schutzsystem vorgesehenen Zertifikat verwechselt werden darf. Diese Komponenten-Bescheinigung darf als Basis für die Bescheinigung eines Gerätes oder Schutzsystems verwendet werden.
- (11) Diese EU-Baumusterprüfbescheinigung bezieht sich nur auf Konzeption und Prüfung des festgelegten Produkts gemäß Richtlinie 2014/34/EU. Weitere Anforderungen dieser Richtlinie gelten für die Herstellung und das Bereitstellen auf dem Markt. Diese Anforderungen werden nicht durch diese Bescheinigung abgedeckt.
- (12) Die Kennzeichnung des Produkts muss die folgenden Angaben enthalten:



II 2 G Ex eb IIC Gb bzw. I M 2 Ex eb I Mb

Konformitätsbewertungsstelle, Sektor Explosionsschutz
Im Auftrag

Dipl.-Phys. U. Völkel



Braunschweig, 30. August 2018

Seite 1/3

EU-Baumusterprüfbescheinigungen ohne Unterschrift und ohne Siegel haben keine Gültigkeit.
Diese EU-Baumusterprüfbescheinigung darf nur unverändert weitervertrieben werden.
Ausgabe oder Änderungen bedürfen der Genehmigung der Physikalisch-Technischen Bundesanstalt.
Physikalisch-Technische Bundesanstalt • Bundesallee 100 • 38116 Braunschweig • DEUTSCHLAND

General Technical Information on Electrical Equipment Used in Hazardous Areas

Continued

Special Requirements

Equipment Protection by Intrinsic Safety "i"
The European EN 60079-11 Standard – Classification VDE 0170-7 – contains special requirements for the design and testing of electrical equipment with "i" (intrinsic safety) protection type for use in hazardous areas.

A circuit is "intrinsically safe" when, under normal operating conditions and in the event of specific fault conditions, no sparks or thermal effects can occur and cause the ignition of a certain explosive atmosphere.

A distinction is made here between:

- intrinsically safe electrical equipment when all circuits are intrinsically safe
- associated electrical equipment including both intrinsically and non-intrinsically safe circuits, and being designed such that the non-intrinsically safe circuits cannot affect the intrinsically safe ones.

Intrinsically safe electrical equipment and intrinsically safe parts of associated electrical equipment are classified at "ia", "ib" or "ic" protection level.

Electrical equipment classified Ex "ia" must not ignite when current is applied in the following cases:

- During fault-free operation, with those non-discreet faults present that result in the most adverse condition
- During fault-free operation and with a discreet fault, plus those non-discreet faults that result in unfavorable conditions
- During fault-free operation with two discreet faults, plus those non-discreet faults that result in the most adverse conditions.

Electrical equipment classified Ex "ib" must not ignite when current is applied in the following cases:

- During fault-free operation, with those non-discreet faults present that result in the most adverse condition
- During fault-free operation and with a discreet fault, plus those non-discreet faults that result in unfavorable conditions.

At applied voltages, the intrinsically safe circuits in electrical equipment of protection level "ic" shall not be capable of causing ignition during undisturbed operation and under the conditions specified in this standard. No special approval is required for terminal blocks used as simple electrical equipment for "Ex i" protection type, as they do not contain a voltage source and precise information is available concerning electrical data and temperature rise performance.

The terminal blocks must be identifiable, for example by their type designation, and the following design requirements must also be upheld:

Clearances and creepage distances between bare conductive parts of terminal blocks of separate intrinsically safe circuits and grounded or floating conductive parts shall be equal to or greater than the values given in Table 5 (see 672). If separate intrinsically safe circuits are to be considered, the air gap between bare conductive parts of the outer connection parts must meet the following requirements:

- at least 6 mm between the separate intrinsically safe circuits
- at least 3 mm from grounded parts, if a possible connection to ground has not been considered in the safety analysis. Each possible motion of metallic parts that are not rigidly secured must be considered.

Terminal block marking must be unique and clearly visible. If a color is used for this, the color must be light blue (similar to RAL 5015).

Note also when using terminal blocks:

Terminal blocks used for intrinsically safe circuits must be isolated from those used in non-intrinsically safe circuits. This is accomplished by several accepted methods. First, intrinsically safe circuits are separated by at least 50 mm of air space from non-intrinsically safe circuits.

Second, intrinsically safe circuits are housed in a separate enclosure. Third, intrinsically safe terminal blocks are separated from non-intrinsically safe terminal blocks by either an insulated partition or grounded metal partition. The partition size must allow for either 1.5 mm or less distance from the sides of the housing or provide at least 50 mm of creepage distance between the intrinsically and non-intrinsically safe circuits in all directions.

The insulation between an intrinsically safe and a non-intrinsically safe circuit has to withstand an effective AC voltage of 2 x nominal value (U) 1000 V or a minimum of 1500 kV, whereby U represents the total of the effective voltages of the intrinsically safe and the non-intrinsically safe circuit.

Short circuit between different intrinsically safe circuits could cause dangerous conditions. The insulation between these circuits should withstand an effective voltage of at least 500 VAC or 2 UAC where U is the total of the effective voltages of the related circuits.

In accordance with EN 60079-14/ DIN VDE 0165-1, in intrinsically safe circuits, the ends of stranded and fine-stranded conductors must be protected against splaying (e.g., via cable lugs or ferrules) or by the type of terminal blocks used. Soldering alone is not sufficient.

WAGO recommends gas-tight tinned copper ferrules or tinned copper pin terminals when connecting fine-stranded conductors to terminal blocks in corrosive atmospheres.

Requirements pertaining to the necessary distances as appropriate for use of the terminal blocks in the area DIN EN 60079-11 (VDE 0170-7) "Explosive atmosphere – Part 11: Device protection by intrinsically safe features "i" (IEC 60079-11)" are defined under Section 6.2 "Connecting point for external circuits," Section 6.2.1 "Terminal blocks." In general, the following can be stated for terminal blocks based on figure 1: "Example of isolated intrinsically safe terminal blocks with partition" in conjunction with figure 2: "Example of isolation of conductive parts," considering Table 5 – "Clearances, Creepage and Isolation Distances."

Outside:

a) Isolated intrinsically safe circuits: at least 6 mm

All PCB terminal blocks listed on the ordering pages as suitable for Ex "i" applications fulfill these requirements.

b) Intrinsically safe circuits and normal circuits (non-intrinsically safe): ≥ 50 mm

Inside:

a) Ex "i" to Ex "i"

b) Ex "i" to normal circuits

c) Ex "i" to ground

Based on Figure 2 and Table 5 (see next page) in accordance with the selected protection level and the special requirements for isolation distances as described in Sections 6.3.1 to 6.3.13, or in accordance with the alternative procedure for dimensioning of isolation distances given in Annex F.

Terminal blocks with smaller pin spacing may also be used for internal connections, provided they meet the requirements laid out in Table 5 (see below).

The exact clearances and creepage distances as well as separation distances based on Table 5 must be derived from the application items cited above.

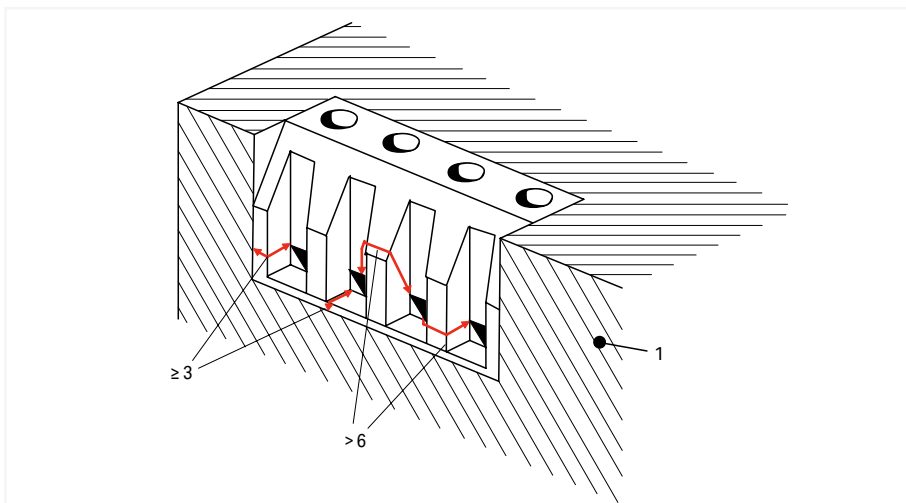
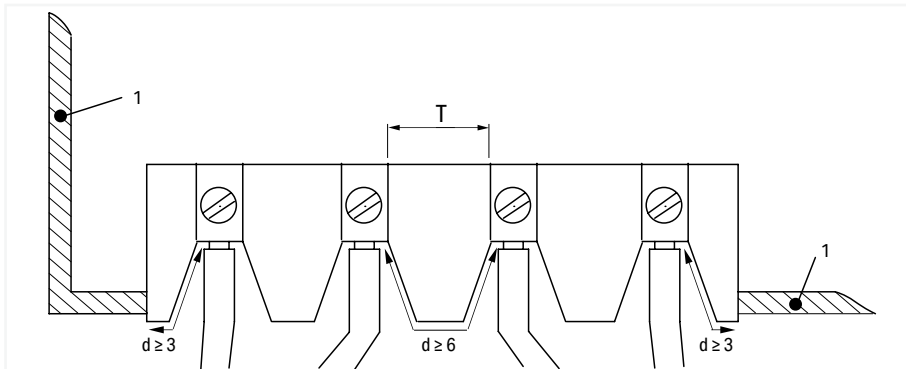

Legend:

- 1 Conductive cover
- T Distances based on Table 5
- d Distance at outer connecting parts of the terminal blocks according to 6.2.1

Note:

The dimensions indicated here represent the clearances and creepage distances around the insulation and not the thickness of the insulation.

Dimensions in mm

Figure 1a: Requirements for clearances and creepage distances for terminal blocks with isolated, intrinsically safe circuits

General Technical Information on Electrical Equipment Used in Hazardous Areas Continued

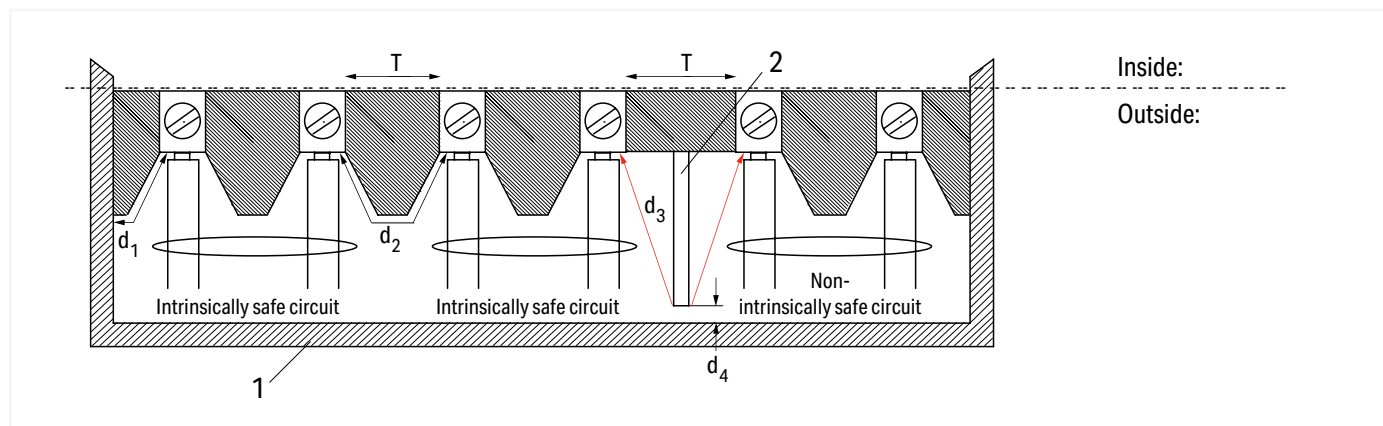

Figure 1b: Example of isolated intrinsically safe and non-intrinsically safe terminal blocks by a partition

Legend:

- 1 Cover: non-conductive or conductive and grounded
- 2 Partition based on 6.2.1 b); in this example, the partition must end at the base
- T Distances based on Table 5
- d1 ≥ 3 mm, when the cover is conductive and grounded
- d2 ≥ 6 mm
- d3 ≥ 50 mm or d4 ≤ 1.5 mm

Note:

The dimensions indicated here represent the clearances around the insulation and not the thickness of the insulation.

Table 5 – Clearances, Creepage and Isolation Distances

1 Voltage (Peak) (V)	2 Clearance (in mm)		3 Separation by Encapsulation (in mm)		4 Separation by Fixed Insulation (in mm)		5 Creepage Distance through Air (in mm)		6 Creepage Distance beneath Protective Layer (in mm)		7 Comparative Tracking Index (CTI)	
	ia, ib	ic	ia, ib	ic	ia, ib	ic	ia, ib	ic	ia, ib	ic	ia	ib, ic
10	1.5	0.4	0.5	0.2	0.5	0.2	1.5	1.0	0.5	0.3	--	
30	2.0	0.8	0.7	0.2	0.5	0.2	2.0	1.3	0.7	0.3	100	100
60	3.0	0.8	1.0	0.3	0.5	0.3	3.0	1.9	1.0	0.6	100	100
90	4.0	0.8	1.3	0.3	0.7	0.3	4.0	2.1	1.3	0.6	100	100
190	5.0	1.5	1.7	0.6	0.8	0.6	8.0	2.5	2.6	1.1	175	175
375	6.0	2.5	2.0	0.6	1.0	0.6	10.0	4.0	3.3	1.7	175	175
550	7.0	4.0	2.4	0.8	1.2	0.8	15.0	6.3	5.0	2.4	275	175
750	8.0	5.0	2.7	0.9	1.4	0.9	18.0	10.0	6.0	2.9	275	175
1000	10.0	7.0	3.3	1.1	1.7	1.1	25.0	12.5	8.3	4.0	275	175
1300	14.0	8.0	4.6	1.7	2.3	1.7	36.0	13.0	12.0	5.8	275	175
1575	16.0	10.0	5.3	*	2.7	*	49.0	15.0	16.3	*	275	175
3.3k	*	18.0	9.0	*	4.5	*	*	32.0	*	*	*	*
4.7k	*	22.0	12.0	*	6.0	*	*	50.0	*	*	*	*
9.5k	*	45.0	20.0	*	10.0	*	*	100.0	*	*	*	*
15.6k	*	70.0	33.0	*	16.5	*	*	150.0	*	*	*	*

Note 1: *At present, no values have been recommended for these voltages.

Note 2: Proof of fulfillment of the CTI requirements for the insulating materials must be provided by the manufacturer. Defining a CTI is not required for insulation materials for voltage levels up to 10 V.

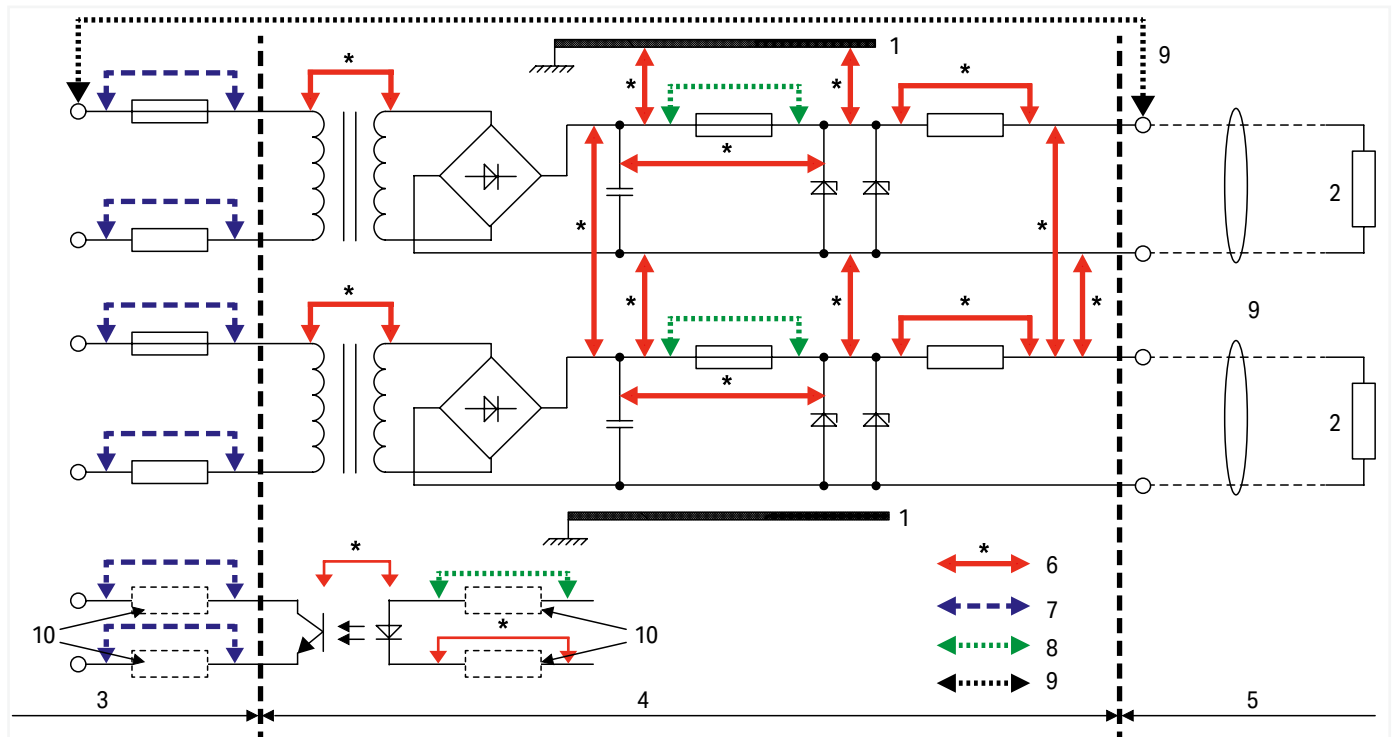

Figure 2: Isolation examples for conductive parts

Legend:

- 1 Chassis
- 2 Load
- 3 Non-intrinsically safe circuit defined by U_m
- 4 Portion of intrinsically safe circuit, item is not intrinsically safe
- 5 Intrinsically safe circuit
- 6 Dimensions for which Table 5 applies
- 7 Dimensions for which general industrial standards apply
- 8 Dimensions per 7.3
- 9 Dimensions based on 6.2.1 for output terminal blocks between isolated intrinsically safe circuits ($d_2 \geq 6 \text{ mm}$) and between intrinsically safe circuits and non-intrinsically safe circuits ($d_3 \geq 50 \text{ mm}$)
- 10 Where required











In accordance with DIN EN 60079-14 (VDE 0165-1), in intrinsically safe circuits, the ends of stranded and fine-stranded conductors must be protected against splaying (e.g., via cable lugs or ferrules) or by the type of terminal blocks used. Soldering alone is not sufficient.

The conductor entry funnels of WAGO PCB terminal blocks fulfill this requirement.

WAGO recommends gas-tight tinned copper ferrules or tinned copper pin terminals when connecting fine-stranded conductors to terminal blocks in corrosive atmospheres.

International Certification Organizations – Overview

		Abbreviation			Abbreviation
	Underwriters Laboratories USA http://www.ul.com	UL		Danmarks Elektriske Materielkontrol Denmark http://www.demko.dk	DEMKO
	Underwriters Laboratories USA http://www.ul.com	UL	CCA 	CENELEC CERTIFICATION AGREEMENT Danmarks Elektriske Materielkontrol Denmark http://www.cenelec.org	CCA Zul.-Nr. mit NL
	Underwriters Laboratories USA http://www.ul.com	cURus			
	Underwriters Laboratories USA http://www.ul.com	cULus		SETI – FEMKO Sähkötarastuskeskus Elinspek- tionscentralen Finland http://www.seti.fi	
	Canadian Standards Association Canada http://www.csa.ca	CSA		Sähkötarastuskeskus Elinspek- tionscentralen Finland http://www.fimko.com	FIMKO
	VDE-Gutachten mit Fertigungsüber- wachung Germany http://www.vde.de/vde/html/e/home.htm	VDE		South African Bureau of Standards South Africa http://www.sabs.co.za	SABS
	VDE – Deutscher Verband für Elek- trotechnik Germany http://www.vde.de				
VDE	VDE – Prüfbericht Germany			RosTest Russia http://www.rostest.ru	ROTEST
	Österreichischer Verband für Elek- trotechnik Austria http://www.ove.at	ÖVE		Departamentul Moldovastandard Moldova http://www.moldova.md/ro/govern- ment/oil/ D_STAND/en/strcent2.htm	CSM
	Schweizerischer Elektrotechnischer Verein Switzerland http://www.sev.ch/	SEV		Certificate of Registration Great Britain http://www.astacertification.com	ASTA
	N.V. tot Keuring van Elektrotech- nische Materialen Netherlands http://www.kema.nl	KEMA		Rheinisch-Westfälischer Technischer Überwachungsverein e.V. Germany http://www.rwtuv.de	RWTÜV
CCA	CENELEC CERTIFICATION AGREEMENT N.V. tot Keuring van Elektrotech- nische Materialen Netherlands http://www.cenelec.org	CCA Zul.-Nr. mit NL		Elektrotechnický ústav projektový ústav Czech Republic http://www.ezu.cz	EZU
				Stowarzyszenie Elektryków Polskich Poland http://www.sep.com.pl	BBJ
	Norges Elektriske Materialkontroll Norway http://express.nemko.com	NEMKO		Stowarzyszenie Elektryków Polskich Poland http://www.bbj.pl	SEP
	Svenska Elektriska Materielkontrol- lanstalten AB Sweden http://www.semko.com	SEMKO			

		Abbreviation			Abbreviation
CNET	Centre National d'Etudes des Télécommunications France http://www.lannion.cnet.fr	CNET		Robbanásbiztos Villamos Berendezések Hungary http://www.bki.hu	BKI
LCIE	Laboratoire Central des Industries Electriques France http://www.lcie.fr	LCIE	CB	CB – TEST CERTIFICATE India http://www.ul-europe.com	CB
	Fyzikální Technický Ústav, Ostrava-Radvanice Czech Republic http://www.ftzu.cz	FTZU	CB	CB – TEST CERTIFICATE China http://www.ul-europe.com	CB
				http://www.enec.com	ENEC
Marine Approvals			EX Approvals		
BV	Bureau Veritas France http://www.bureauveritas.fr	BV		Physikalisch Technische Bundesanstalt Germany http://www.ptb.de	PTB
	Lloyd's Register of Shipping Great Britain http://www.lloydsregister.com	LR		Underwriters Laboratories USA http://www.ul.com	AEx
	NV – Det Norske Veritas Norway http://www.dnvgl.com	DNV-GL			
	Russian Maritime Register of Shipping GUS http://www.rs-head.spb.ru	RMR			
	Polski Rejestr Statków Poland http://www.prs.pl	PRS			
	Korean Register of Shipping Korea http://www.krs.co.kr	KR			
ABS	American Bureau of Shipping USA http://www.eagle.org	ABS			

Electrical Engineering Laboratory Product Safety for Our Customers

To use terminal blocks globally, they must satisfy certain standards and obtain test certificates. These requirements apply to every manufacturer. WAGO also conducts its own tests to increase standards and offer greater reliability with its products. Products undergo a full range of mechanical, electrical and climatic testing, and we'll share a few of those processes with you.

Pull-Out Test (per EN 60947-7-1, EN 60998-2-2)

During the pull-out force test, a conductor is pulled on until it is removed from the clamping unit. The design of the terminals means that extraction only occurs after the standard pull-out force has been exceeded many times over.

WAGO Test Lab

This means that WAGO's products can be used safely and reliably both in Europe and anywhere globally for a wide variety of applications. We heavily emphasize the importance of global acceptance during development. As a result, we can present documentation that verifies our high levels of product safety and reliability while ensuring the fulfillment and accuracy of technical data, which are the highest priorities for our customers and users worldwide. On December 22, 2009, our test lab was accredited by the German Accreditation Association (Deutsche Gesellschaft für Akkreditierung GmbH) in accordance with DIN EN ISO/IEC 17025.



Vibration Test (per IEC/EN 60068-2-6)

Depending on the application, such as railway (per EN 61373) or marine (per GL, LR, DNV), there are various testing requirements to determine if the long-term effects of vibrations degrade electrical connections. The test specimen is subjected to different loads on three axes in an electrodynamic vibration system. The amplitude, the acceleration, and particularly the frequency of the vibration vary during the test. The test values are increased many times over the standard values to meet special customer requirements.

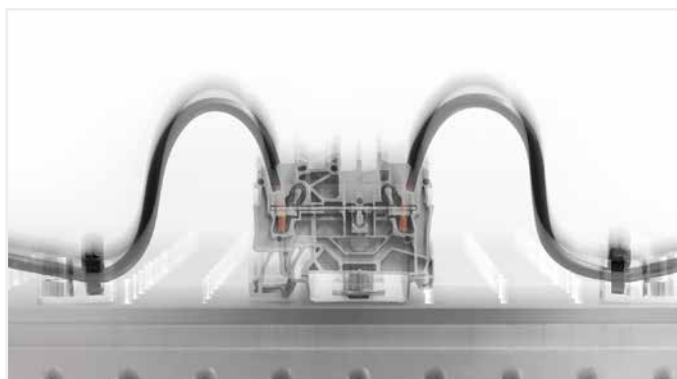

Shock Test (per IEC/EN 60068-2-27)

The shock test is very similar to the vibration test except that, instead of continuous vibrations, single shocks are applied to the test specimen. Shock tests are usually performed, for example, at an acceleration of 20g over a period of 11 ms. Tests for special requirements often call for much higher values and are also conducted in our laboratory.



Voltage Drop Test under Bending Stress (per WAGO test requirements)

The voltage drop test under bending stress simulates mechanical stress on the clamping unit. In everyday use, this stress can occur during installation, for example, when an electrician shoves connected conductors to the side in order to access a specific component. The quality of the clamping unit when moving a connected conductor can be validated by the constantly stable measured value of the voltage drop.





Deutsche Akkreditierungsstelle GmbH

Beliehene gemäß § 8 Absatz 1 AkkStelleG i.V.m. § 1 Absatz 1 AkkStelleGBV
 Unterzeichnerin der Multilateralen Abkommen
 von EA, ILAC und IAF zur gegenseitigen Anerkennung

Akkreditierung



Die Deutsche Akkreditierungsstelle GmbH bestätigt hiermit, dass

das Prüflaboratorium WAGO Kontakttechnik GmbH & Co. KG
Hansastraße 27, 32423 Minden

die Kompetenz nach DIN EN ISO/IEC 17025:2018 besitzt, Prüfungen in folgenden Bereichen durchzuführen:

**Elektrische und mechanische Prüfungen an Klemmen und Steckverbinder
 sowie Umweltsimulation**

Die Akkreditierungsurkunde gilt nur in Verbindung mit dem Bescheid vom 24.05.2019 mit der Akkreditierungsnummer D-PL-19704-01. Sie besteht aus diesem Deckblatt, der Rückseite des Deckblatts und der folgenden Anlage mit insgesamt 08 Seiten.

Registrierungsnummer der Urkunde: D-PL-19704-01-00

Frankfurt am Main, 24.05.2019

Im Auftrag Dipl.-Ing. (FH) Ralf Egner
 Abteilungsleiter

Die Urkunde samt Urkundenanlage gibt den Stand zum Zeitpunkt des Ausstellungsdatums wieder. Der jeweils aktuelle Stand des Geltungsbereiches der Akkreditierung ist der Datenbank akkreditierter Stellen der Deutschen Akkreditierungsstelle GmbH (DAkks) zu entnehmen. <https://www.dakks.de/content/datenbank-akkreditierter-stellen>

Siehe Hinweise auf der Rückseite

WAGO-Seminars

Learn Today – Benefit Tomorrow

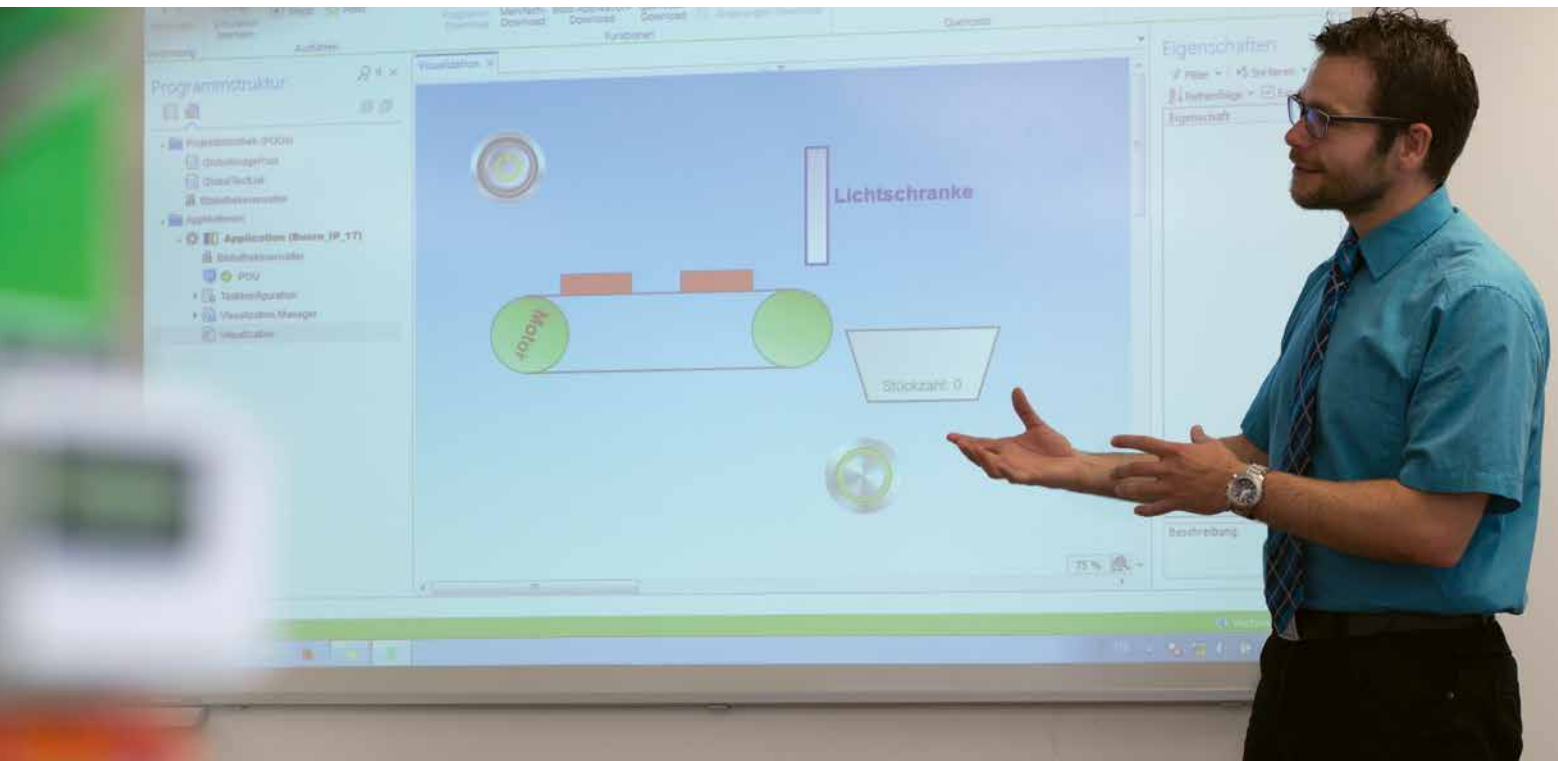

Setting the Bar with Your Goals

Product-Related and Customer-Specific Seminars



Small Groups

The small class sizes of WAGO training seminars ensures that no question goes unanswered and no one is overlooked.



Teamwork

Learning as a group is very effective. Ideas can be discussed and exchanged while experiences can be shared – all for the benefit of the participants.



Practical Topics

Experience has shown that practice makes perfect. This is why the focus of every WAGO training seminar is on practical, hands-on learning.

WAGO-Seminars

Experience the Benefits of First-Hand Knowledge and Expertise – Straight from the Source

Our instructors are specialists who know all the ins and outs of WAGO's products. This ensures that the time devoted to each WAGO training seminar is an effective investment in expanding your own expertise.

Request your registration form by email:
training@wago.com

Contact your local
WAGO office.

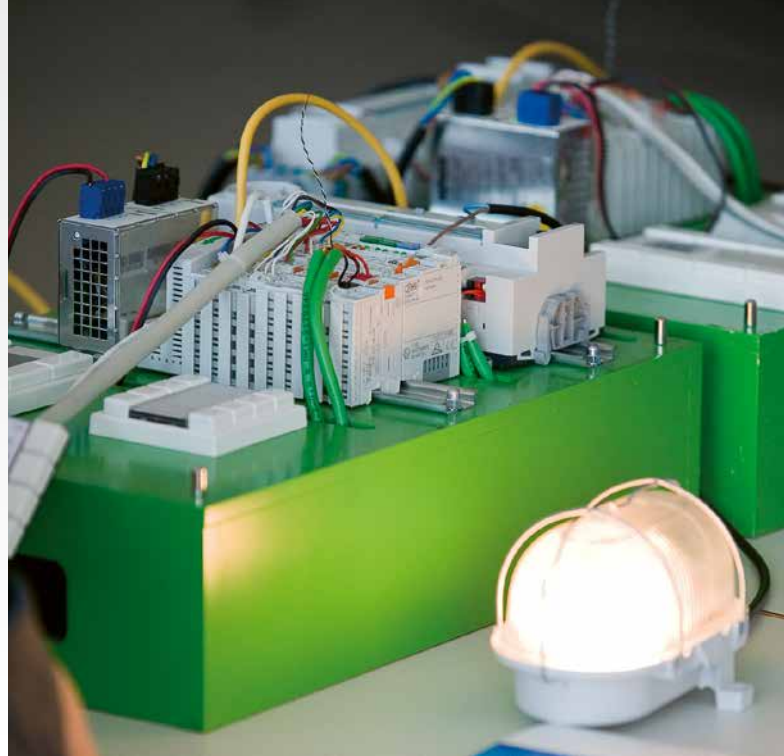

Product-Related Seminars

We regularly offer product-related seminars on the following topics:

- Building and industrial automation
- Programming of automation components
- Fieldbus systems

Current Seminars at:
www.wago.com

Customer-Specific Training Seminars

In addition to these "open" seminars, we also offer seminars specially tailored to your organization and its particular needs.

Upon request, we can also conduct these courses at your location.

Special
Corporate Seminars



Indexes

Indexes

	Page
Product Index	780
Item Number Index	784
Environmental protection at WAGO Success for generations	802

Product Index

Item	Page	Item	Page	Item	Page
A					
Actuator and actuator LED terminal blocks		Diode modules on carrier terminal blocks	416	Ex e II	
– Rail-mount terminal blocks, TOPJOB® S	148	– TOPJOB® S	160	– Through terminal blocks; f.-e.	
– Rail-mount terminal blocks, Classic	399	Diode modules on through terminal blocks	417	– angled type	316
– Rail-mount terminal blocks, Compact	523	– TOPJOB® S	161	– TOPJOB® S	58
Actuator terminal blocks; with a pluggable signal level	153	Diode terminal blocks; f.-e.	406	– TOPJOB® Classic	343
Additional modules for matrix patchboards	600	– TOPJOB® S	154	– horizontal type	312
"Alu-Plus" contact paste	724	Diode triple-deck terminal blocks; f.-e.		– TOPJOB® S	52
– Technical information	757	– TOPJOB® S	174	– with lever and Push-in CAGE CLAMP®	26
Angled support bracket	701	– Compact	516	– with lever and push-button	31
Assembly tool; for 294 Series	573	Disconnect and test terminal blocks; f.-e.		– with push-button	36
B					
Banana plugs	722	– angled type	366	– Double- and triple-deck terminal blocks, TOPJOB® S	72
Board sets	272	– Double-deck, TOPJOB® S	86	– Double-potential terminal blocks; f.-e.	313
Busbar carriers	673	– for current and voltage transformer circuits	362	– TOPJOB® S	53
Busbar terminal blocks	611	– TOPJOB® S	136	– Ground conductor terminal blocks; f.-e.	
C					
Cable strippers	710	– horizontal type		– angled type	316
Cable cutter	720	– Double-deck, TOPJOB® S	168	– TOPJOB® S	58
Cable knife	710	– with a pivoting knife disconnect	352	– TOPJOB® Classic	343
CAGE CLAMP® connection	728	– TOPJOB® S	106	– horizontal type	312
Carrier terminal blocks; f.-e.	378	– with push-button	94	– TOPJOB® S	52
– as double-, triple-deck terminal blocks	334	– Disconnect tab	354	– with lever and Push-in CAGE CLAMP®	26
– TOPJOB® S	107	Disconnect and test terminal blocks; s.-e.	584	– with lever and push-button	31
– with push-button	94	Disconnection tool; for 294 Series	573	– with push-button	36
– as double-deck terminal blocks	86	Disconnect terminal blocks; f.-e.		– Disconnect and test terminal blocks TOPJOB® S	106
– Multilevel installation terminal blocks, TOPJOB® S	260	– angled type		– Double-deck disconnect/test terminal blocks	168
– X-COM®S-SYSTEM-MINI	194	– for current and voltage transformer circuits	362	– High-current through terminal blocks; s.-e.	298
– X-COM®S-SYSTEM	212	– Double-deck, TOPJOB® S	86	– High-current ground conductor terminal blocks; s.-e.	298
– X-COM®S-SYSTEM; for Ex ec applications	228	– horizontal type		– Modular terminal blocks and terminal strips with mounting flanges or snap-in mounting feet	
– X-COM®-SYSTEM	436	– with a pivoting knife disconnect	368	– f.-e.	532
CE marking	730	– TOPJOB® S	106	– s.-e.	550
Certification organizations – overview	772	– with push-button	94	– Compact through terminal blocks; for DIN-35 and DIN-15 rails	508
Chassis-mount terminal strips	558	– with a disconnect tab	354	– Compact ground conductor terminal blocks; for DIN-35 and DIN-15 rails	508
CLASSIC splicing connectors for all conductor types	653	– Double-deck terminal blocks	333	– Mini through terminal blocks	
Collective jumper carriers	701	– TOPJOB® S	168	– for DIN-35 and DIN-15 rails	504
– TOPJOB® S	185	Disconnect terminal blocks for test and measurement		– TOPJOB® S; for DIN-15 rails	282
Comb-style jumper bars	425	– see "Disconnect and test terminal blocks"		– TOPJOB® S; for surface mounting	286
Common potential and matrix patching terminal blocks (4- and 8-level terminal blocks)	604	Distribution terminal blocks; f.-e.	325	– Mini ground conductor terminal blocks	504
Common potential matrix patchboards	596	Double-deck carrier terminal blocks	334	– for DIN-35 and DIN-15 rails	504
COMPACT splicing connectors	615	– TOPJOB® S	86	– TOPJOB® S; for DIN-15 rails	282
COMPACT splicing connectors (4 mm ² /12 AWG) for all conductor types	627	– X-COM®S-SYSTEM-MINI	196	– TOPJOB® S; for surface mounting	286
COMPACT splicing connectors (4 mm ² /12 AWG); for Ex eb applications	636	– X-COM®S-SYSTEM	216	– Mini through terminal blocks	504
COMPACT splicing connectors (6 mm ² /10 AWG) for all conductor types	633	– X-COM®S-SYSTEM; for Ex ec applications	232	– for DIN-35 and DIN-15 rails	504
COMPACT splicing connectors (6 mm ² /10 AWG); for Ex eb applications	637	– X-COM®-SYSTEM	466	– TOPJOB® S; for DIN-15 rails	282
Compact terminal blocks		Double-deck rail-mount terminal blocks; f.-e.	328	Ex i terminal blocks	
– see "Mini (rail-mount) terminal blocks"		– Compact	510	– see "Through terminal blocks"	
Compact terminal blocks	558	– TOPJOB® S	72	Ex applications:	
Compact terminal strips	527	– with push-button	70	– Technical information	761
Component plugs on carrier terminal blocks	166	– Disconnect terminal blocks, TOPJOB® S	86	Ex PUSH WIRE® connectors for junction boxes	620
Control cabinet outlet	699	– Disconnect and test terminal blocks, TOPJOB® S	168	F	
Covers for rail-mount terminal blocks	704	– Carrier terminal blocks, TOPJOB® S	86	Felt-tip pen	695
Crimping tools for ferrules	714	– Fuse terminal blocks, TOPJOB® S	87	Female plugs with Push-in CAGE CLAMP® connection	
Current-carrying capacity curves		– Diode and LED terminal blocks	412	– X-COM®S-SYSTEM-MINI	198
– X-COM®-SYSTEM	495	– Compact	514	– X-COM®S-SYSTEM	218
Current transformer terminal blocks	136	– TOPJOB® S	172	– X-COM®S-SYSTEM; for Ex ec applications	234
D					
Delta jumper	185	Double-fuse plugs on carrier terminal blocks	262	Female plugs with CAGE CLAMP® connection	
– Compact	513	Double-potential terminal blocks; f.-e.	313	– X-COM®-SYSTEM	486
Derating curves		– TOPJOB® S	53	Ferrules	717
– see "Current-carrying capacity curves"		– as terminal blocks for matrix patching	609	– TOPJOB® S	715
DIN-rails 15	707	– Compact	509	– High-current rail-mount terminal blocks	719
DIN-rails 35	700	E		– 4-conductor chassis-mount terminal strips	716
Diode double-deck terminal blocks; f.-e.	412	EC directives	730	Field-wiring terminal blocks	566
– TOPJOB® S	172	Electrical interconnection sets	68	Fuse modules; for carrier terminal blocks	378
– Compact	514	Electric motor wiring (quadruple-deck) rail-mount terminal blocks	340	– TOPJOB® S	140
E					
Empty component plug on carrier terminal blocks	164	– TOPJOB® S	92	Fuse terminal blocks; f.-e.	
End stops		Empty component plug on carrier terminal blocks	164	– angled type	
– for DIN-15 rail	753	End stops		– for automotive blade-style fuses	370
– for DIN-35 rail	702	– for DIN-15 rail	753	– with a pivoting fuse holder	374
Environmental protection at WAGO	802	– for DIN-35 rail	702	– Double-deck terminal blocks, TOPJOB® S	87
Ex eb		Environmental protection at WAGO	802	– horizontal type	
COMPACT Splicing connectors (4 mm ² /12 AWG); for Ex eb applications	636	Ex eb		– TOPJOB® S	106
Ex ec		COMPACT Splicing connectors (4 mm ² /12 AWG); for Ex eb applications	636	– with push-button	94
X-COM®S-SYSTEM		Ex ec		– with a pivoting fuse holder, TOPJOB® S	116
– Carrier terminal blocks	228	X-COM®S-SYSTEM		– with push-button	104
– Double-deck carrier terminal blocks	232	– Carrier terminal blocks	228	Fuse plugs on carrier terminal blocks	378
– Female plugs with Push-in CAGE CLAMP® connection	234	– Double-deck carrier terminal blocks	232	– TOPJOB® S	140
		– Female plugs with Push-in CAGE CLAMP® connection	234	– for double-/triple-deck terminal blocks	334
				– double-, TOPJOB® S	262
				Fuse terminal blocks; s.-e.	586
				– for cylindrical fuses and class CC fuses	382

Item	Page	Item	Page	Item	Page
G					
Ground conductor disconnect terminal blocks; f.-e.	368				
– TOPJOB® S	124				
Ground conductor disconnect terminal blocks; s.-e.	585				
Ground conductor terminal blocks, Compact					
– for DIN-35 and DIN-15 rails	508				
Ground conductor terminal blocks; f.-e.					
– angled type	316				
– TOPJOB® S	58				
– with push-button	42				
– TOPJOB® Classic	343				
– for current and voltage transformer circuits	363				
– TOPJOB® S	137				
– horizontal type	312				
– TOPJOB® S	52				
– with lever and Push-in CAGE CLAMP®	26				
– with lever and push-button	31				
– with push-button	36				
– Double-deck terminal blocks	328				
– TOPJOB® S	72				
– with push-button	70				
– Triple-deck terminal blocks	338				
– TOPJOB® S	90				
– Distribution terminal blocks, TOPJOB® S	270				
Ground conductor terminal blocks, Mini					
– for DIN-35 and DIN-15 rails	504				
– TOPJOB® S; for DIN-15 rails	282				
Ground conductor terminal blocks; s.-e.	580				
– High-current~	298				
H					
High-current rail-mount terminal blocks with POWER CAGE CLAMP connection	Section 5				
I					
IEC/EN specifications	731				
Inline splicing connectors	647				
Installation distribution terminal blocks					
– see "Multilevel installation terminal blocks"					
Installation rail-mount terminal blocks					
– see "Multilevel installation terminal blocks"					
Insulation stops					
– for rail-mount terminal blocks, Classic	424				
– X-COM®-SYSTEM	436				
– for matrix patchboards	601				
Item Number Index	784				
J					
Jumpers for rail-mount terminal blocks					
– see "Step-down jumpers, staggered jumpers, push-in type wire jumpers"					
Junction boxes; for 221 Series splicing connectors (4 mm ²)	645				
Junction box connectors	Section 13				
L					
Lamp demonstration connectors ("Service" connectors)	657				
	658				
L-BOXX® 102	412				
LED double-deck terminal blocks; f.-e.	172				
– TOPJOB® S	514				
– Compact	416				
LED modules on carrier terminal blocks	160				
– TOPJOB® S	417				
LED modules on through terminal blocks	161				
– TOPJOB® S	406				
LED terminal blocks; f.-e.	154				
– TOPJOB® S					
LED triple-deck terminal blocks; f.-e.	174				
– TOPJOB® S	516				
– Compact	657				
Lighting connectors	657				
Longitudinal switching disconnect terminal blocks	366				
Luminaire disconnect connectors	662				
M					
Male connectors with CAGE CLAMP®connection					
– X-COM®-SYSTEM	476				
Male headers with solder pins					
– X-COM®-SYSTEM	480				
Marking accessories	Section 14, Volume 6				
– Compact	513				
Material specifications for insulation/contact materials, contact plating	760				
Matrix patchboards	592				
Matrix patching and common potential terminal blocks (4- and 8-level terminal blocks)	604				
MICRO PUSH WIRE® connectors for junction boxes	624				
Mini through terminal blocks, f.-e.					
– for DIN-35 and DIN-15 rails	504				
Mini ground terminal blocks; f.-e.					
– for DIN-35 and DIN-15 rails	504				
Modular connectors					
– TOPJOB® S	176				
– X-COM®S-SYSTEM	Section 2				
– X-COM®-SYSTEM	Section 7				
Modular terminal blocks and terminal strips					
– see "Terminal blocks and terminal strips"					
Modular terminal blocks and terminal strips with mounting flanges or snap-in mounting feet					
– Compact	528				
– f.-e.	532				
– s.-e.	538				
Modular test plug adapters					
– see "Test plug adapters"					
Mounting carrier for inline splicing connectors	649				
Mounting carrier for single connectors	630				
Mounting carrier for splicing connectors					
– 221 Series (4 mm ² /12 AWG connectors)	629				
– 221 Series (6 mm ² /10 AWG connectors)	633				
– 222 Series	655				
– 243 Series	625				
– 773 Series	617				
– 773 Series Ex	621				
– 2273 Series	615				
Mounting foot					
– for isolated DIN-rail mounting	703				
– for busbars	668				
Multilevel installation terminal blocks as carrier terminal blocks TOPJOB® S	260				
Multilevel installation terminal blocks; with an internal Multilevel installation terminal blocks; with an N-disconnect slide link TOPJOB® S	256				
Multilevel installation terminal blocks; with N-disconnection TOPJOB® S	258				
Multilevel rail-mount terminal blocks					
– see "Double-, triple-, quadruple-deck terminal blocks"					
Multilevel terminal blocks					
– see "Multilevel installation terminal blocks"					
– see "Double-, triple- and quadruple-deck terminal blocks"					
N					
N-conductor disconnect terminal blocks					
– TOPJOB® S	268				
– TOPJOB® Classic	347				
Neon lamp modules on carrier terminal blocks	416				
Neon lamp modules on through terminal blocks	417				
O					
Operating pliers	709				
Operating tools	708				
– TOPJOB® S	708				
– TOPJOB® Classic	343				
– High-current rail-mount terminal blocks	709				
Order form available upon request					
P					
Patchboard systems					
– Matrix patchboards	592				
– Common potential matrix patchboards	596				
– Matrix patching and common potential terminal blocks (4- and 8-level terminal blocks)	604				
– Terminal blocks for matrix patching (3-conductor, double-potential terminal blocks)	609				
Pluggable tap-off modules	519				
POWER CAGE CLAMP connection	729				
Power distribution disconnect terminal blocks					
– TOPJOB® S	268				
– TOPJOB® Classic	347				
Power taps; for high-current terminal blocks	298				
Printer	697				
Push-in CAGE CLAMP® connection	728				
Push-in type wire jumpers for rail-mount terminal blocks	427				
– TOPJOB® S	186				
PUSH WIRE® connection	729				
PUSH WIRE® connectors for junction boxes	618				
PUSH WIRE® connectors for junction boxes, Ex e II	620				
PUSH WIRE® connectors for junction boxes, MICRO	624				
Q					
Quadruple-deck rail-mount terminal blocks (for fast electric motor wiring)	340				
– TOPJOB® S	92				
R					
Rail end cap; for DIN-35 rail	700				
Rail-mount spacer blocks	314				
Rail-mount terminal block sets	68				
S					
Screwdrivers					
– see "Operating tools"					
Sensor and sensor LED terminal blocks					
– Rail-mount terminal blocks, TOPJOB® S	146				
– Rail-mount terminal blocks, Classic	390				
– Rail-mount terminal blocks, Compact	521				
Sensor terminal blocks; with a pluggable signal level	151				
"Service" connectors	657				
Sets, electrical interconnection set and rail-mount terminal block set	68				
Shield clamping saddles	668				
Shield clamps	672				
Shield terminal blocks					
– angled type	316				
– TOPJOB® S	58				
– TOPJOB® Classic	343				
– horizontal type	312				
– TOPJOB® S	54				
– Double-deck terminal blocks, TOPJOB® S	73				
– Triple-deck terminal blocks	338				
– TOPJOB® S	90				
Spacers for sensor/actuator terminal blocks	390				
Specifications IEC/EN	731				
Specifications UL – Underwriters Laboratories, USA	752				
Splicing connectors (4 mm ² /12 AWG) for all conductor types, COMPACT	627				
Splicing connectors (4 mm ² /12 AWG); for Ex eb applications, COMPACT	636				
Splicing connectors (6 mm ² /10 AWG) for all conductor types, COMPACT	633				
Splicing connectors (6 mm ² /10 AWG); for Ex eb applications, COMPACT	637				
Splicing connectors, COMPACT	615				
Splicing connectors for all conductor types, CLASSIC	653				
Splicing connector set	658				
Spring-equipped shield clamping saddles	671				
Staggered jumpers for rail-mount terminal blocks	426				
– TOPJOB® S	184				
Star point jumper	185				

Product Index

Item	Page	Item	Page	Item	Page
S		T		T	
Step-down jumpers for through terminal blocks		Through terminal blocks; s.-e.	580	Transverse switching terminal blocks	366
– TOPJOB® S	65	– High-current~	298	Triple-deck carrier terminal blocks	335
– High-current; 35 mm ² /2 AWG	298	Tools	Section 14	Triple-deck installation terminal blocks, TOPJOB® S	256
– f.-e.	326	TOPJOB® terminal blocks with CAGE CLAMP® connection		Triple-deck rail-mount terminal blocks; f.-e.	338
– s.-e.	583	– Through terminal blocks	343	– Compact	512
Stickers with operating instructions		– Ground terminal blocks	343	– TOPJOB® S	90
– see www.wago.com		– Shield terminal blocks	343	– Diode and LED terminal blocks	
Strain relief housings		– N-conductor disconnect terminal blocks	347	– Compact	516
– X-COM®-SYSTEM	494	– Power distribution disconnect terminal blocks	347	– TOPJOB® S	174
Strain relief plates		TOPJOB® S terminal blocks with Push-in CAGE CLAMP® connection			
– X-COM®S-SYSTEM	200	– Through terminal blocks	52	U	
– X-COM®-SYSTEM	476	– with lever and Push-in CAGE CLAMP®	26	UL Specifications – Underwriters Laboratories, USA	752
– for 294 Series	573	– with lever and push-button	31		
Strain reliefs	573	– with push-button	36	V	
Stripping pliers	712	– for current and voltage transformer circuits	136	Voltage testers	721
Switch cabinet drawer	699	– Double-potential terminal blocks	53	Voltage transformer terminal blocks	136
Supply terminal blocks		– Ground conductor terminal blocks	52		
– Ground conductor terminal block		– with lever and Push-in CAGE CLAMP®	26		
– TOPJOB® S	270	– with lever and push-button	31		
– TOPJOB® Classic	346	– with push-button	36		
– N-conductor disconnect terminal blocks		– for current and voltage transformer circuits	137		
– TOPJOB® S	270	– Shield terminal blocks	54	W	
– TOPJOB® Classic	348	– Double-deck terminal blocks	72	WAGO	
Supply terminal blocks for distribution boxes TOPJOB® S	270	– with push-button	70	– Connection technologies	728
		– Double-deck disconnect terminal blocks	86	– CAGE CLAMP® connection	728
		– Double-deck disconnect/test terminal blocks	168	– POWER CAGE CLAMP connection	729
		– Double-deck carrier terminal blocks	86	– Push-in CAGE CLAMP® connection	728
		– Double-deck fused disconnect terminal blocks with a pivoting fuse holder	87	– PUSH WIRE® connection	729
		– Triple-deck terminal blocks	90	WFB continuous marking strips	695
		– Quadruple-deck terminal blocks	92	Wire jumpers for rail-mount terminal blocks; push-in type	
		– Carrier terminal blocks	107	– TOPJOB® S	427
		– with push-button	94	– TOPJOB® S	186
		– Disconnect and test terminal blocks	106	Wire harness support	609
		– with push-button	94	Wire strippers	713
		– Disconnect/test terminal blocks for current and voltage transformer circuits	136		
		– Fuse terminal blocks	106	X	
		– with push-button	94	X-COM®S-SYSTEM-MINI	
		– Fused disconnect terminal blocks with a pivoting fuse holder	116	– Carrier terminal blocks	194
		– with push-button	104	– Double-deck carrier terminal blocks	196
		– Ground conductor disconnect terminal blocks	124	– Female plugs with Push-in CAGE CLAMP® connection	198
		– Terminal block assemblies for current and voltage circuits	138		
		– Fuse plugs	140	X-COM®S-SYSTEM	
		– Sensor terminal blocks	146	– Carrier terminal blocks	212
		– Sensor terminal blocks; with a pluggable signal level	151	– Double-deck carrier terminal blocks	216
		– Actuator terminal blocks	148	– Female plugs with Push-in CAGE CLAMP® connection	218
		– Actuator terminal blocks; with a pluggable signal level	153		
		– Diode and LED terminal blocks	154	X-COM®S-SYSTEM; for Ex ec applications	
		– Double-deck diode and LED terminal blocks	172	– Carrier terminal blocks	228
		– Triple-deck diode and LED terminal blocks	174	– Double-deck carrier terminal blocks	232
		– Diode modules on carrier terminal blocks	160	– Female plugs with Push-in CAGE CLAMP® connection	234
		– Diode modules on through terminal blocks	161		
		– LED modules on carrier terminal blocks	160	X-COM®-SYSTEM	
		– LED modules on through terminal blocks	161	– Carrier terminal blocks	436
		– Empty component plug on carrier terminal blocks	164	– Double-deck carrier terminal blocks	466
		– Component plugs on carrier terminal blocks	166	– Female plugs with CAGE CLAMP® connection	486
		– Modular connectors and connector strips	176	– Male connectors with CAGE CLAMP® connection	476
		– Test plug modules	180	– Male headers with solder pins	480
		– Multilevel installation terminal blocks with an N-disconnect slide link	256		
		– Multilevel installation terminal blocks with an internal N-disconnection	258	Y	
		– Multilevel installation terminal blocks as carrier terminal blocks	260	Yellowoxes for splicing connectors	641
		– Double-fuse plugs on carrier terminal blocks	262		
		– N-conductor disconnect terminal blocks	268		
		– Power distribution disconnect terminal blocks	268		
		– Supply terminal blocks for distribution boxes	270		
		– Miniature Through terminal blocks			
		– for DIN-15 rails	282		
		– for surface mounting	286		
		– Miniature Ground conductor terminal blocks			
		– for DIN-15 rails	282		
		– Tools	708		
		Transformer terminal blocks			
		– see "Disconnect and test terminal blocks"			

Item	Page	Item	Page

Item No.	Page	Item No.	Page	Item No.	Page	Item No.	Page
248 Series		260 Series		261 Series		261 Series	
248-501/000-012	685	260-258	539	261-154	541	261-259	541
248-501/000-017	685	260-259	539	261-154/331-000	543	261-259/332-000	543
248-501/000-023	685	260-260	539	261-154/341-000	545	261-259/342-000	545
248-501/000-024	685	260-261	539	261-155	541	261-260	541
249 Series		260-262	539	261-155/331-000	543	261-260/332-000	543
249-101	707	260-301	538	261-155/341-000	545	261-260/342-000	545
249-105	695	260-303	538	261-156	541	261-261	541
249-106	421	260-304	538	261-156/331-000	543	261-261/332-000	543
249-107	421	260-306	538	261-156/341-000	545	261-261/342-000	545
249-109	604	260-307	538	261-157	541	261-262	541
249-116	702	260-311	538	261-157/331-000	543	261-262/332-000	543
249-117	702	260-313	538	261-157/341-000	545	261-262/342-000	545
249-118	693	260-314	538	261-158	541	261-301	540
249-119	693	260-316	538	261-158/331-000	543	261-301/331-000	542
249-120	693	260-317	538	261-158/341-000	545	261-301/341-000	544
249-125	313	260-321	538	261-159	541	261-303	540
249-126	313	260-323	538	261-159/331-000	543	261-303/331-000	542
249-127	313	260-324	538	261-159/341-000	545	261-303/341-000	544
249-130	724	260-326	538	261-160	541	261-304	540
249-135	538	260-327	538	261-160/331-000	543	261-304/331-000	542
249-136	504	260-331	538	261-160/341-000	545	261-304/341-000	544
249-137	548	260-333	538	261-161	541	261-306	540
249-138	538	260-334	538	261-161/331-000	543	261-306/331-000	542
249-139	504	260-336	538	261-161/341-000	545	261-306/341-000	544
249-140	548	260-337	538	261-162	541	261-307	540
249-141	317	260-341	538	261-162/331-000	543	261-307/331-000	542
249-142	420	260-343	538	261-162/341-000	545	261-307/341-000	544
249-143	420	260-344	538	261-202	541	261-311	540
249-144	420	260-346	538	261-202/332-000	543	261-311/331-000	542
249-145	420	260-347	538	261-202/342-000	545	261-311/341-000	544
249-146	420	260-351	538	261-203	541	261-313	540
249-147	421	260-353	538	261-203/332-000	543	261-313/331-000	542
249-148	421	260-354	538	261-203/342-000	545	261-313/341-000	544
249-197	298	260-356	538	261-204	541	261-314	540
258 Series		260-357	538	261-204/332-000	543	261-314/331-000	542
258-5000	697	260-361	538	261-204/342-000	545	261-314/341-000	544
258-5030	697	260-371	538	261-205	541	261-316	540
260 Series		260-402	538	261-205/332-000	543	261-316/331-000	542
260-102	539	260-404	538	261-205/342-000	545	261-316/341-000	544
260-103	539	260-405	538	261-206	541	261-317	540
260-104	539	261 Series		261-206/332-000	543	261-317/331-000	542
260-105	539	261-102	541	261-206/342-000	545	261-317/341-000	544
260-106	539	261-102/331-000	543	261-207	541	261-321	540
260-107	539	261-102/341-000	545	261-207/332-000	543	261-321/331-000	542
260-108	539	261-103	541	261-207/342-000	545	261-321/341-000	544
260-109	539	261-103/331-000	543	261-208	541	261-323	540
260-110	539	261-103/341-000	545	261-208/332-000	543	261-323/331-000	542
260-111	539	261-104	541	261-208/342-000	545	261-323/341-000	544
260-112	539	261-104/331-000	543	261-209	541	261-324	540
260-152	539	261-104/341-000	545	261-209/332-000	543	261-324/331-000	542
260-153	539	261-105	541	261-209/342-000	545	261-324/341-000	544
260-154	539	261-105/331-000	543	261-210	541	261-326	540
260-155	539	261-105/341-000	545	261-210/332-000	543	261-326/331-000	542
260-156	539	261-106	541	261-210/342-000	545	261-326/341-000	544
260-157	539	261-106/331-000	543	261-211	541	261-327	540
260-158	539	261-106/341-000	545	261-211/332-000	543	261-327/331-000	542
260-159	539	261-107	541	261-211/342-000	545	261-327/341-000	544
260-160	539	261-107/331-000	543	261-212	541	261-331	540
260-161	539	261-107/341-000	545	261-212/332-000	543	261-331/332-000	542
260-162	539	261-108	541	261-212/342-000	545	261-331/342-000	544
260-202	539	261-108/331-000	543	261-252	541	261-333	540
260-203	539	261-108/341-000	545	261-252/332-000	543	261-333/332-000	542
260-204	539	261-109	541	261-252/342-000	545	261-333/342-000	544
260-205	539	261-109/331-000	543	261-253	541	261-334	540
260-206	539	261-109/341-000	545	261-253/332-000	543	261-334/332-000	542
260-207	539	261-110	541	261-253/342-000	545	261-334/342-000	544
260-208	539	261-110/331-000	543	261-254	541	261-336	540
260-209	539	261-110/341-000	545	261-254/332-000	543	261-336/332-000	542
260-210	539	261-111	541	261-254/342-000	545	261-336/342-000	544
260-211	539	261-111/331-000	543	261-255	541	261-337	540
260-212	539	261-111/341-000	545	261-255/332-000	543	261-337/332-000	542
260-252	539	261-112	541	261-255/342-000	545	261-337/342-000	544
260-253	539	261-112/331-000	543	261-256	541	261-341	540
260-254	539	261-112/341-000	545	261-256/332-000	543	261-341/332-000	542
260-255	539	261-152	541	261-256/342-000	545	261-341/342-000	544
260-256	539	261-152/331-000	543	261-257	541	261-343	540
260-257	539	261-152/341-000	545	261-257/332-000	543	261-343/332-000	542
		261-153	541	261-257/342-000	545	261-343/342-000	544
		261-153/331-000	543	261-258	541	261-344	540
		261-153/341-000	545	261-258/332-000	543	261-344/332-000	542
				261-258/342-000	545	261-344/342-000	544

Item Number Index

Item No.	Page	Item No.	Page	Item No.	Page	Item No.	Page
261 Series		262 Series		262 Series		264 Series	
261-346	540	262-135	551	262-306	548	264-204	534
261-346/332-000	542	262-136	551	262-307	548	264-205	534
261-346/342-000	544	262-137	551	262-311	548	264-206	534
261-347	540	262-138	551	262-314	548	264-207	534
261-347/332-000	542	262-139	551	262-316	548	264-208	534
261-347/342-000	544	262-140	551	262-317	548	264-209	534
261-351	540	262-141	551	262-321	548	264-210	534
261-351/332-000	542	262-142	551	262-324	548	264-211	534
261-351/342-000	544	262-152	549	262-326	548	264-212	534
261-353	540	262-153	549	262-327	548	264-220	505
261-353/332-000	542	262-154	549	262-331	548	264-225	504
261-353/342-000	544	262-155	549	262-334	548	264-230	532
261-354	540	262-156	549	262-336	548	264-231	532
261-354/332-000	542	262-157	549	262-337	548	264-232	534
261-354/342-000	544	262-158	549	262-341	548	264-233	534
261-356	540	262-159	549	262-344	548	264-234	534
261-356/332-000	542	262-160	549	262-346	548	264-235	534
261-356/342-000	544	262-161	549	262-347	548	264-236	534
261-357	540	262-162	549	262-351	548	264-237	534
261-357/332-000	542	262-180	550	262-354	548	264-238	534
261-357/342-000	544	262-181	550	262-356	548	264-239	534
261-361	540	262-182	551	262-357	548	264-240	534
261-371	540	262-183	551	262-361	548	264-241	534
261-402	540	262-184	551	262-363	550	264-242	534
261-404	540	262-185	551	262-371	548	264-252	534
261-405	540	262-186	551	262-373	550	264-253	534
261-410	546	262-187	551	262-402	548	264-254	534
261-411	546	262-188	551			264-255	534
261-411/331-000	546	262-189	551			264-256	534
261-411/341-000	546	262-190	551	264 Series		264-257	534
261-422	547	262-191	551	264-102	534	264-258	534
261-422/331-000	547	262-192	551	264-103	534	264-259	534
261-422/341-000	547	262-202	549	264-104	534	264-260	534
261-423	547	262-203	549	264-105	534	264-261	534
261-423/331-000	547	262-204	549	264-106	534	264-262	534
261-423/341-000	547	262-205	549	264-107	534	264-280	533
261-424	547	262-206	549	264-108	534	264-282	534
261-424/331-000	547	262-207	549	264-109	534	264-283	534
261-424/341-000	547	262-208	549	264-110	534	264-284	534
261-425	547	262-209	549	264-111	534	264-285	534
261-425/331-000	547	262-210	549	264-112	534	264-286	534
261-425/341-000	547	262-211	549	264-120	505	264-287	534
261-426	547	262-212	549	264-125	504	264-288	534
261-426/331-000	547	262-230	550	264-130	532	264-289	534
261-426/341-000	547	262-232	551	264-131	532	264-290	534
261-427	547	262-233	551	264-132	534	264-291	534
261-427/331-000	547	262-234	551	264-133	534	264-292	534
261-427/341-000	547	262-235	551	264-134	534	264-301	532
261-428	547	262-236	551	264-135	534	264-304	532
261-428/331-000	547	262-237	551	264-136	534	264-306	532
261-428/341-000	547	262-238	551	264-137	534	264-307	532
261-429	547	262-239	551	264-138	534	264-311	533
261-429/331-000	547	262-240	551	264-139	534	264-314	533
261-429/341-000	547	262-241	551	264-140	534	264-316	533
261-430	547	262-242	551	264-141	534	264-317	533
261-430/331-000	547	262-252	549	264-142	534	264-321	532
261-430/341-000	547	262-253	549	264-152	534	264-324	532
261-431	547	262-254	549	264-153	534	264-326	532
261-431/331-000	547	262-255	549	264-154	534	264-327	532
261-431/341-000	547	262-256	549	264-155	534	264-331	532
261-432	547	262-257	549	264-156	534	264-334	532
261-432/331-000	547	262-258	549	264-157	534	264-336	532
261-432/341-000	547	262-259	549	264-158	534	264-337	532
		262-260	549	264-159	534	264-341	533
		262-261	549	264-160	534	264-344	533
		262-262	549	264-161	534	264-346	533
		262-280	550	264-162	534	264-347	533
		262-281	550	264-180	533	264-351	532
		262-282	551	264-182	534	264-354	532
		262-283	551	264-183	534	264-356	532
		262-284	551	264-184	534	264-357	532
		262-285	551	264-185	534	264-361	532
		262-286	551	264-186	534	264-363	532
		262-287	551	264-187	534	264-364	532
		262-288	551	264-188	534	264-367	504
		262-289	551	264-189	534	264-368	504
		262-290	551	264-190	534	264-369	504
		262-291	551	264-191	534	264-370	504
		262-292	551	264-192	534	264-371	533
		262-301	548	264-202	534	264-373	533
		262-304	548	264-203	534	264-374	533
262 Series							
262-102	549						
262-103	549						
262-104	549						
262-105	549						
262-106	549						
262-107	549						
262-108	549						
262-109	549						
262-110	549						
262-111	549						
262-112	549						
262-130	550						
262-132	551						
262-133	551						
262-134	551						

Item Number Index

Item No.	Page	Item No.	Page	Item No.	Page	Item No.	Page
280 Series		281 Series		281 Series		281 Series	
280-675	609	280-916	380	281-512/281-417	378	281-687	318
280-681	314	280-940/281-410	412	281-512/281-418	378	281-687/999-950	318
280-683	354	280-940/281-411	412	281-512/281-501	334	281-901	318
280-684	314	280-941/281-489	412	281-530	340	281-902	318
280-687	314	280-941/281-490	412	281-531	340	281-903	318
280-687/999-950	314	280-941/281-491	412	281-532	340	281-904	318
280-801/281-411	416	280-941/281-492	412	281-610	378	281-905	318
280-801/281-413	418	280-942/281-487	412	281-611	374	281-906	318
280-801/281-414	418	280-942/281-488	412	281-611/281-417	374	281-907	318
280-801/281-415	418	280-943/281-413	412	281-611/281-418	374	281-907/999-950	318
280-801/281-416	418	280-943/281-434	412	281-611/281-541	374	281-912	356
280-801/281-417	418	280-946	317	281-611/281-542	374	281-915/281-400	410
280-801/281-418	418	280-992	314	281-612	374	281-915/281-401	410
280-801/281-420	416	280-993	314	281-612/281-417	374	281-915/281-410	410
280-801/281-421	416	280-994	314	281-612/281-418	374	281-915/281-411	410
280-803/281-411	417	280-995	315	281-612/281-541	374	281-916	378
280-803/281-413	419	280-996	317	281-612/281-542	374	281-992	318
280-803/281-414	419	280-998	316	281-613	376	281-993	318
280-803/281-415	419			281-613/281-417	376	281-994	318
280-803/281-416	419	281 Series		281-613/281-418	376	281-998	319
280-803/281-417	419	281-101	580	281-613/281-541	376		
280-803/281-418	419	281-104	580	281-613/281-542	376	282 Series	
280-803/281-420	417	281-107	580	281-616	374	282-101	581
280-805	354	281-301	580	281-619	336	282-104	581
280-809/281-413	408	281-302	580	281-620	336	282-107	581
280-809/281-434	408	281-309	375	281-622	374	282-120	586
280-815/281-410	408	281-311	375	281-622/281-417	374	282-122	586
280-815/281-411	408	281-312	318	281-622/281-418	374	282-124	586
280-816	380	281-313	318	281-622/281-541	374	282-126	586
280-826	315	281-318	318	281-622/281-542	374	282-128	586
280-829	354	281-322	580	281-623	376	282-128/281-413	587
280-830	314	281-324	318	281-623/281-417	376	282-128/281-417	587
280-831	314	281-326	318	281-623/281-418	376	282-128/281-418	587
280-832	314	281-328	318	281-623/281-541	376	282-131	584
280-833	314	281-329	318	281-623/281-542	376	282-133	584
280-834	314	281-330	318	281-624	375	282-135	584
280-835	314	281-331	318	281-629	336	282-137	584
280-835/056-000	314	281-332	580	281-630	336	282-138	585
280-836	354	281-333	580	281-631	319	282-139	585
280-837	314	281-334	318	281-633/281-410	414	282-140	585
280-837/999-950	314	281-335	318	281-633/281-411	414	282-141	585
280-838	314	281-338	318	281-634/281-413	414	282-301	580
280-839	354	281-339	318	281-634/281-434	414	282-302	580
280-850	380	281-340	336	281-635/281-489	414	282-308	320
280-850/281-413	380	281-341	336	281-635/281-490	414	282-309	320
280-852	380	281-342	336	281-635/281-491	414	282-311	586
280-852/281-413	380	281-343	336	281-635/281-492	414	282-312	586
280-854	380	281-344	318	281-636/281-487	414	282-314	584
280-854/281-413	380	281-344	356	281-636/281-488	414	282-315	584
280-856	380	281-345	318	281-637	319	282-322	580
280-856/281-413	380	281-346	318	281-637/999-950	319	282-325	320
280-868	352	281-347	318	281-651	319	282-326	320
280-869	352	281-348	318	281-652	318	282-328	320
280-870	352	281-350	318	281-653	318	282-329	320
280-871	352	281-355	318	281-654	318	282-330	320
280-874	353	281-356	318	281-656	378	282-331	320
280-875	353	281-357	318	281-657	318	282-332	580
280-876	352	281-358	318	281-657/999-950	318	282-333	368
280-879	352	281-365	340	281-658	318	282-334	368
280-880	352	281-366	340	281-659	356	282-339	320
280-881	353	281-402	319	281-660	356	282-340	320
280-882	353	281-405	580	281-663	318	282-341	320
280-883	353	281-407	315	281-664	318	282-342	320
280-884	353	281-409	319	281-665/281-400	410	282-357	320
280-885	353	281-415	319	281-665/281-401	410	282-358	320
280-889	335	281-418	319	281-665/281-410	410	282-360	366
280-891	334	281-419	319	281-665/281-411	410	282-361	366
280-901	314	281-421	333	281-666	356	282-365	366
280-902	314	281-422	319	281-668	318	282-366	366
280-902/056-000	314	281-440	709	281-672	375	282-367	320
280-903	314	281-470	318	281-673/281-400	410	282-368	320
280-904	314	281-471	318	281-673/281-401	410	282-369	701
280-905	314	281-472	318	281-673/281-410	410	282-370	366
280-906	314	281-482	319	281-673/281-411	410	282-372	366
280-907	314	281-483	319	281-678	318	282-373	366
280-907/999-950	314	281-485	319	281-679	318	282-374	366
280-912	354	281-490	319	281-681	318	282-384	362
280-913	354	281-492	319	281-683	356	282-385	362
280-914	354	281-503	140	281-684	318	282-386	362
280-915/281-410	408	281-511	334	281-685	318	282-387	362
280-915/281-411	408	281-512	334	281-686	318	282-390	362

Item No.	Page	Item No.	Page	Item No.	Page	Item No.	Page
282 Series		282 Series		284 Series		285 Series	
282-391	362	282-905	320	284-343	580	285-447	302
282-392	362	282-906	320	284-344	313	285-448	303
282-402	320	282-907	320	284-346	312	285-449	302
282-405	580	282-907/999-950	320	284-357	321	285-450	302
282-409	320	282-992	320	284-358	321	285-495	304
282-415	302	282-993	320	284-367	321	285-633	324
282-422	320			284-368	321	285-634	324
282-424	362	283 Series		284-400	321	285-635	324
282-432	136	283-101	582	284-402	321	285-636	324
282-432/100-000	136	283-104	582	284-405	582	285-637	324
282-433	136	283-107	582	284-409	321	285-637/999-950	324
282-433/011-000	136	283-301	582	284-412	325	285-639	324
282-433/100-000	136	283-302	582	284-413	319	285-935	298
282-434	136	283-322	582	284-414	313	285-950	302
282-434/100-000	136	283-325	322	284-415	304	285-992	324
282-435	136	283-326	322	284-422	321	285-995	304
282-435/011-000	136	283-328	322	284-621	325	285-1161	307
282-435/300-000	136	283-329	322	284-624	325	285-1163	307
282-435/301-000	366	283-330	322	284-681	321	285-1164	307
282-436	136	283-331	322	284-682	321	285-1165	307
282-436/301-000	136	283-332	582	284-684	321	285-1167	307
282-436/304-000	366	283-333	582	284-687	321	285-1167/999-950	307
282-437	136	283-335	582	284-687/999-950	321	285-1169	306
282-437/011-000	136	283-350	323	284-901	321	285-1171	306
282-437/012-000	136	283-351	323	284-902	321	285-1175	306
282-438	136	283-352	323	284-903	321	285-1176	306
282-438/300-000	136	283-353	323	284-904	321	285-1177	306
282-438/301-000	136	283-354	323	284-905	321	285-1178	306
282-439	136	283-355	323	284-906	321	285-1179	307
282-439/011-000	136	283-357	322	284-907	321	285-1181	306
282-440	136	283-367	322	284-907/999-950	321	285-1184	306
282-442	366	283-400	322	284-992	321	285-1185	306
282-443	366	283-402	322	284-993	321	285-1187	306
282-444	366	283-404	298			285-1187/999-950	306
282-445	366	283-405	582	285 Series		285-1189	306
282-446	366	283-407	298	285-131	298		
282-451	586	283-409	322	285-134	298	294 Series	
282-452	586	283-414	322	285-135	298	294-364	573
282-453	586	283-415	322	285-137	298	294-370	573
282-454	586	283-422	322	285-137/999-950	298	294-375	573
282-457	586	283-671	323	285-139	298	294-384	573
282-458	586	283-672	323	285-141	303	294-4002	567
282-638	368	283-674	323	285-143	303	294-4003	567
282-639	368	283-677	323	285-144	303	294-4004	569
282-640	368	283-677/999-950	323	285-147	303	294-4005	571
282-641	368	283-901	322	285-147/999-950	303	294-4006	572
282-681	320	283-902	322	285-148	303	294-4007	572
282-682	320	283-903	322	285-150	302	294-4012	567
282-684	320	283-904	322	285-151	302	294-4013	567
282-687	320	283-905	322	285-154	302	294-4014	569
282-687/999-950	320	283-906	322	285-157	302	294-4015	571
282-694	368	283-907	322	285-157/999-950	302	294-4022	567
282-695	368	283-907/999-950	322	285-159	302	294-4023	567
282-696	370	283-992	322	285-168	305	294-4024	569
282-697	368	283-998	323	285-169	304	294-4025	571
282-698/281-413	370			285-170	304	294-4032	567
282-698/281-429	370	284 Series		285-172	302	294-4035	571
282-698/281-434	370	284-101	582	285-173	709	294-4042	567
282-698/281-449	370	284-104	582	285-175	304	294-4043	567
282-699	368	284-107	582	285-181	305	294-4044	569
282-811	366	284-301	582	285-184	305	294-4045	571
282-821	366	284-302	582	285-187	305	294-4052	567
282-841	366	284-308	321	285-188	305	294-4053	567
282-841/049-000	367	284-309	321	285-191	304	294-4055	571
282-860	362	284-322	582	285-194	304	294-4072	567
282-865	362	284-325	321	285-195	304	294-4075	571
282-866	363	284-326	321	285-197	304	294-4093/3025-000	567
282-868	363	284-328	321	285-197/999-950	304	294-4094/4025-000	569
282-870	362	284-329	321	285-199	304	294-4095/5025-000	571
282-881	136	284-330	321	285-401	324	294-4095/5026-000	571
282-882	136	284-331	321	285-407	304	294-4095/5027-000	571
282-883	136	284-332	582	285-416	324	294-4213	569
282-884	136	284-333	580	285-420	298	294-4214	571
282-885	136	284-334	313	285-421	298	294-4215	571
282-886	136	284-336	312	285-427	298	294-4223	569
282-887	136	284-336	318	285-430	298	294-4224	571
282-888	136	284-339	321	285-435	298	294-4225	571
282-901	320	284-340	321	285-440	302	294-4235	571
282-902	320	284-341	321	285-441	302	294-4253	569
282-903	320	284-342	321	285-442	298	294-4255	571
282-904	320						

Item Number Index

Item No.	Page	Item No.	Page	Item No.	Page	Item No.	Page
294 Series		294 Series		726 Series		727 Series	
294-4275	571	294-5425	571	726-741	594	727-229	604
294-4313	569	294-5435	571	726-770	599	727-230	604
294-4314	571	294-5453	569	726-771	599	727-231	604
294-4315	572	294-5455	571	726-780	599	727-232	604
294-4323	569	294-5475	571	726-800	599	727-233	604
294-4324	571			726-801	599	727-234	604
294-4325	572			726-821	594	727-235	605
294-4335	572	709 Series		726-841	594	727-236	605
294-4353	569	709-107	592	726-901	592	727-237	605
294-4355	572	709-110	363	726-902	592	727-238	605
294-4375	572	709-111	363	726-903	600	727-255	604
294-4413	569	709-112	363	726-904	600	727-256	604
294-4414	569	709-118	693	726-906	592	727-257	604
294-4415	571	709-119	693	726-907	592	727-258	604
294-4423	569	709-120	693	727 Series		727-265	604
294-4424	569	709-153	705	727-105	606	727-266	604
294-4425	571	709-154	705	727-106	606	727-267	604
294-4435	571	709-156	706	727-107	606	727-268	604
294-4453	569	709-167	705	727-108	606	734-326	178
294-4455	571	709-168	705	727-109	606	734-327	178
294-4475	571	709-169	706	727-113	606	734-328	176
294-5002	567	709-170	355	727-114	606	734-329	178
294-5003	567	709-177	340	727-115	606	734-430	218
294-5004	569	709-178	558	727-116	606	734-431	218
294-5005	571	709-183	705	727-117	606		
294-5012	567	709-196	517	727-119	606	769 Series	
294-5013	567	709-310	320	727-120	606	769-101	436
294-5014	569	709-311	345	727-121	606	769-101/000-006	486
294-5015	571	709-312	321	727-122	606	769-101/022-000	436
294-5022	567	709-322	423	727-123	606	769-102	477
294-5023	567	709-324	423	727-124	606	769-102/021-000	477
294-5024	569	709-326	423	727-125	607	769-103	486
294-5025	571	709-332	423	727-126	607	769-103/000-036	492
294-5032	567	709-334	423	727-127	607	769-103/000-037	492
294-5035	571	709-336	423	727-128	607	769-103/000-038	492
294-5042	567	709-350	672	727-129	606	769-103/000-039	493
294-5043	567	709-352	672	727-130	606	769-103/021-000	487
294-5044	569	709-581	699	727-131	606	769-103/022-000	489
294-5045	571	709-582	699	727-132	606	769-104	486
294-5052	567	709-583	699	727-133	606	769-104/000-036	492
294-5053	567	709-591	699	727-134	606	769-104/000-037	492
294-5055	571			727-135	607	769-104/000-038	492
294-5072	567	726 Series		727-136	607	769-104/000-039	493
294-5075	571	726-121	592	727-137	607	769-104/021-000	487
294-5093/3025-000	567	726-122	592	727-138	607	769-104/022-000	489
294-5094/4025-000	569	726-141	592	727-155	606	769-105	486
294-5095/5025-000	571	726-142	592	727-156	606	769-105/000-036	492
294-5095/5026-000	571	726-221	592	727-157	606	769-105/000-037	492
294-5095/5027-000	571	726-222	592	727-158	606	769-105/000-038	492
294-5113	567	726-241	592	727-159	606	769-105/000-039	493
294-5114	569	726-242	592	727-160	606	769-105/021-000	487
294-5123	567	726-241	592	727-161	606	769-105/022-000	489
294-5124	569	726-321	595	727-162	606	769-106	486
294-5153	567	726-322	595	727-163	606	769-106/000-036	492
294-5155	571	726-325	595	727-164	606	769-106/000-037	492
294-5175	571	726-326	595	727-165	606	769-106/000-038	492
294-5213	569	726-341	595	727-166	606	769-106/000-039	493
294-5214	571	726-342	595	727-167	606	769-106/021-000	487
294-5215	571	726-345	595	727-168	606	769-106/022-000	489
294-5223	569	726-346	595	727-169	606	769-107	486
294-5224	571	726-421	593	727-170	606	769-107/000-036	492
294-5225	571	726-441	593	727-197	604	769-107/000-037	492
294-5235	571	726-521	593	727-198	604	769-107/000-038	492
294-5253	569	726-541	593	727-199	604	769-107/000-039	493
294-5255	571	726-601	596	727-205	604	769-107/021-000	487
294-5275	571	726-602	596	727-206	604	769-107/022-000	489
294-5313	569	726-611	596	727-207	604	769-108	486
294-5314	571	726-612	596	727-208	604	769-108/000-036	492
294-5315	572	726-621	596	727-213	604	769-108/000-037	492
294-5323	569	726-622	596	727-214	604	769-108/000-038	492
294-5324	571	726-631	596	727-217	604	769-108/000-039	493
294-5325	572	726-631	597	727-219	604	769-108/021-000	487
294-5335	572	726-632	596	727-220	604	769-108/022-000	489
294-5353	569	726-632	597	727-221	604	769-109	486
294-5355	572	726-651	598	727-222	604	769-109/000-036	492
294-5375	572	726-652	598	727-223	604	769-109/000-037	492
294-5413	569	726-661	598	727-224	604	769-109/000-038	492
294-5414	569	726-662	598	727-225	605	769-109/000-039	493
294-5415	571	726-671	598	727-226	605	769-109/021-000	487
294-5423	569	726-672	598	727-227	605	769-109/022-000	489
294-5424	569	726-721	594	727-228	605	769-110	486

Item No.	Page	Item No.	Page	Item No.	Page	Item No.	Page
769 Series		769 Series		769 Series		769 Series	
769-110/000-036	492	769-202	449	769-503	490	769-612	476
769-110/000-037	492	769-203	449	769-503/000-006	490	769-612/001-000	476
769-110/000-038	492	769-207	442	769-503/000-016	490	769-612/002-000	476
769-110/000-039	493	769-208/281-410	451	769-504	490	769-612/004-000	476
769-110/021-000	487	769-208/281-411	451	769-504/000-006	490	769-612/005-000	478
769-110/022-000	489	769-209/281-413	453	769-504/000-016	490	769-612/006-000	479
769-111	486	769-209/281-434	453	769-505	490	769-613	476
769-111/000-036	492	769-211	440	769-505/000-006	490	769-613/001-000	476
769-111/000-037	492	769-212	449	769-505/000-016	490	769-613/002-000	476
769-111/000-038	492	769-213	449	769-506	490	769-613/004-000	476
769-111/000-039	493	769-214	446	769-506/000-006	490	769-613/005-000	478
769-111/021-000	487	769-217	440	769-506/000-016	490	769-613/006-000	479
769-111/022-000	489	769-218/281-410	451	769-512	490	769-614	476
769-112	486	769-218/281-411	451	769-512/000-006	490	769-614/001-000	476
769-112/000-036	492	769-219/281-413	453	769-512/000-016	490	769-614/002-000	476
769-112/000-037	492	769-219/281-434	453	769-513	490	769-614/004-000	476
769-112/000-038	492	769-221	438	769-513/000-006	490	769-614/005-000	478
769-112/000-039	493	769-222	448	769-513/000-016	490	769-614/006-000	479
769-112/021-000	487	769-223	448	769-515	490	769-615	476
769-112/022-000	489	769-227	438	769-515/000-006	490	769-615/001-000	476
769-113	486	769-228/281-410	450	769-515/000-016	490	769-615/002-000	476
769-113/000-036	492	769-228/281-411	450	769-602	476	769-615/004-000	476
769-113/000-037	492	769-229/281-413	452	769-602/001-000	476	769-615/005-000	478
769-113/000-038	492	769-229/281-434	452	769-602/002-000	476	769-615/006-000	479
769-113/000-039	493	769-231	436	769-602/004-000	476	769-632	480
769-113/021-000	487	769-232	448	769-602/005-000	478	769-632/000-036	480
769-113/022-000	489	769-233	448	769-602/006-000	479	769-632/003-000	481
769-114	486	769-237	436	769-603	476	769-632/003-036	481
769-114/000-036	492	769-238/281-410	450	769-603/001-000	476	769-632/004-000	482
769-114/000-037	492	769-238/281-411	450	769-603/002-000	476	769-632/007-000	484
769-114/000-038	492	769-239/281-413	452	769-603/004-000	476	769-633	480
769-114/000-039	493	769-239/281-434	452	769-603/005-000	478	769-633/000-036	480
769-114/021-000	487	769-242	456	769-603/006-000	479	769-633/003-000	481
769-114/022-000	489	769-243	456	769-604	476	769-633/003-036	481
769-115	486	769-251	444	769-604/001-000	476	769-633/004-000	482
769-115/000-036	492	769-251/000-006	444	769-604/002-000	476	769-633/007-000	484
769-115/000-037	492	769-257	444	769-604/004-000	476	769-634	480
769-115/000-038	492	769-301	442	769-604/005-000	478	769-634/000-036	480
769-115/000-039	493	769-302	442	769-604/006-000	479	769-634/003-000	481
769-115/021-000	487	769-303	440	769-605	476	769-634/003-036	481
769-115/022-000	489	769-304	440	769-605/001-000	476	769-634/004-000	482
769-121	436	769-305	438	769-605/002-000	476	769-634/007-000	484
769-121/000-016	488	769-306	438	769-605/004-000	476	769-635	480
769-122	477	769-307	436	769-605/005-000	478	769-635/000-036	480
769-123	488	769-308	436	769-605/006-000	479	769-635/003-000	481
769-124	488	769-309	449	769-606	476	769-635/003-036	481
769-125	488	769-310	449	769-606/001-000	476	769-635/004-000	482
769-126	488	769-311	449	769-606/002-000	476	769-635/007-000	484
769-127	488	769-312	449	769-606/004-000	476	769-636	480
769-128	488	769-313	449	769-606/005-000	478	769-636/003-000	481
769-129	488	769-314	449	769-606/006-000	479	769-636/003-036	481
769-130	488	769-315	446	769-607	476	769-636/004-000	482
769-131	488	769-317	456	769-607/001-000	476	769-636/007-000	484
769-132	488	769-318	456	769-607/002-000	476	769-637	480
769-133	488	769-319	456	769-607/004-000	476	769-637/003-000	481
769-134	488	769-320	444	769-607/005-000	478	769-637/004-000	482
769-135	488	769-402	486	769-607/006-000	479	769-637/007-000	484
769-151	442	769-410	298	769-608	476	769-638	480
769-156	438	769-411	476	769-608/001-000	476	769-638/003-000	481
769-156/000-006	438	769-412	476	769-608/002-000	476	769-638/004-000	482
769-161	460	769-413	476	769-608/004-000	476	769-638/007-000	484
769-162/769-313	460	769-414	476	769-608/005-000	478	769-639	480
769-163/769-313	460	769-428	486	769-608/006-000	479	769-639/003-000	481
769-164/769-313	460	769-429	486	769-609	476	769-639/004-000	482
769-165/769-313	460	769-430	486	769-609/001-000	476	769-639/007-000	484
769-171	440	769-431	486	769-609/002-000	476	769-640	480
769-171/000-006	440	769-434	477	769-609/004-000	476	769-640/003-000	481
769-176	436	769-435	436	769-609/005-000	478	769-640/004-000	482
769-176/000-006	436	769-436	486	769-609/006-000	479	769-640/007-000	484
769-176/000-012	436	769-438	436	769-610	476	769-641	480
769-181	458	769-439	436	769-610/001-000	476	769-641/003-000	481
769-182/769-314	458	769-470	436	769-610/002-000	476	769-641/004-000	482
769-183/769-314	458	769-471	436	769-610/004-000	476	769-641/007-000	484
769-184/769-314	458	769-472	436	769-610/005-000	478	769-642	480
769-185/769-314	458	769-499	476	769-610/006-000	479	769-642/003-000	481
769-191	462	769-501	490	769-611	476	769-642/004-000	482
769-192/769-319	462	769-501/000-006	490	769-611/001-000	476	769-642/007-000	484
769-193/769-319	462	769-501/000-016	490	769-611/002-000	476	769-643	480
769-194/769-319	462	769-502	490	769-611/004-000	476	769-643/003-000	481
769-195/769-319	462	769-502/000-006	490	769-611/005-000	478	769-643/004-000	482
769-201	442	769-502/000-016	490	769-611/006-000	479	769-643/007-000	484

Item Number Index

Item No.	Page	Item No.	Page	Item No.	Page	Item No.	Page
769 Series		773 Series		783 Series		793 Series	
769-644	480	773-496	620	783-607/999-950	346	793-4501/000-007	684
769-644/003-000	481	773-498	620	783-613	348	793-4501/000-012	684
769-644/004-000	482	773-504	619	783-623	348	793-4501/000-017	684
769-644/007-000	484	773-514	619	783-992	346	793-4501/000-023	684
769-645	480	773-602	618	784 Series		793-4501/000-024	684
769-645/003-000	481	773-604	618	784-601	345	793-5500/793-035	592
769-645/004-000	482	773-606	618	784-604	345	793-5501	684
769-645/007-000	484	777 Series		784-604	345	793-5501/000-002	684
769-662	480	777-300	347	784-607	345	793-5501/000-005	684
769-662/003-000	481	777-303	256	784-607/999-950	345	793-5501/000-006	684
769-662/004-000	482	777-305	345	784-613	348	793-5501/000-007	684
769-663	480	777-310	343	784-623	348	793-5501/000-012	684
769-663/003-000	481	780 Series		784-992	345	793-5501/000-017	684
769-663/004-000	482	780-317	343	785 Series		793-5501/000-023	684
769-664	480	780-321	347	785-601	349	793-5501/000-024	684
769-664/003-000	481	780-452	315	785-604	240	793-5502	592
769-664/004-000	482	780-453	315	785-607	256	793-5566	592
769-665	480	780-454	315	785-613	349	794 Series	
769-665/003-000	481	780-455	315	785-623	349	794-4615	334
769-665/004-000	482	780-456	315	790 Series		794-4616	334
769-666	480	780-457	315	790-100	668	794-4617	334
769-666/003-000	481	780-458	315	790-101	668	794-4618	334
769-666/004-000	482	780-601	343	790-108	668	794-4619	334
769-667	480	780-602	343	790-110	668	794-5553/000-002	136
769-667/003-000	481	780-604	343	790-112	668	794-5554/000-006	136
769-667/004-000	482	780-607	343	790-114	668	794-5615	140
769-668	480	780-607/999-950	343	790-115	668	794-5616	140
769-668/003-000	481	780-613	347	790-116	668	794-5617	140
769-668/004-000	482	780-631	343	790-114	668	794-5618	140
769-669	480	780-637	343	790-115	668	794-5619	140
769-669/003-000	481	780-637/999-950	343	790-116	668	811 Series	
769-669/004-000	482	780-640	343	790-124	668	811-310	382
769-670	480	780-651	343	790-133	668	811-311	382
769-670/003-000	481	780-654	343	790-134	668	811-314	382
769-670/004-000	482	780-992	343	790-140	668	811-316	382
769-671	480	780-993	343	790-144	668	811-317	382
769-671/003-000	481	781 Series		790-145	668	811-320	382
769-671/004-000	482	781-452	319	790-190	668	811-321	382
769-672	480	781-453	319	790-191	668	811-322	382
769-672/003-000	481	781-454	319	790-192	668	811-330	382
769-672/004-000	482	781-455	319	790-193	668	811-331	382
769-673	480	781-456	319	790-208	671	811-410	382
769-673/003-000	481	781-601	344	790-216	671	811-411	382
769-673/004-000	482	781-604	344	790-220	671	811-414	382
769-674	480	781-607	344	790-300	674	811-420	382
769-674/003-000	481	781-607/999-950	344	790-301	674	811-421	382
769-674/004-000	482	781-613	347	790-302	674	811-422	382
769-675	480	781-623	347	790-310	675	811-430	382
769-675/003-000	481	781-631	344	790-311	675	811-431	382
769-675/004-000	482	781-637	344	790-312	675	811-471	382
769-1602	494	781-637/999-950	344	790-350/790-398	676	811-472	383
769-1603	494	781-643	347	790-352/790-398	676	811-473	383
769-1604	494	781-651	344	790-360/790-398	676	811-474	383
769-1605	486	781-653	347	790-362/790-398	676	811-475	383
769-1606	494	781-992	344	790-398	676	811-476	383
769-1607	494	781-993	344	790-400	673	811-477	383
769-1608	494	782 Series		791 Series		811-478	383
769-1609	494	782-300	348	791-107	672	811-479	383
769-1610	494	782-317	345	791-111	672	811-480	383
769-1611	494	782-321	348	791-117	672	811-481	383
769-1612	494	782-601	345	791-124	672	811-482	383
769-1613	494	782-604	345	793 Series		811-612	382
769-1614	494	782-607	345	793-501	684	811-1316	384
769-1615	494	782-607/999-950	345	793-501/000-002	684	812 Series	
773 Series		782-613	348	793-501/000-005	684	812-100	611
773-112	617	782-623	348	793-501/000-006	684	812-101	611
773-114	617	782-992	345	793-501/000-007	684	812-102	611
773-116	617	783 Series		793-501/000-012	684	812-103	611
773-118	617	783-317	346	793-501/000-017	684	812-104	611
773-124	618	783-321	348	793-501/000-023	684	812-110	611
773-162	616	783-601	346	793-501/000-024	684	812-111	611
773-164	616	783-604	346	793-933	606	812-112	611
773-166	616	783-607	346	793-3501	684	812-113	611
773-168	616	788 Series		793-4501	684	812-114	611
773-173	618	788-317	346	793-4501/000-002	684	812-140	611
773-331	621	788-601	346	793-4501/000-005	684	812-141	611
773-332	615	793 Series		793-4501/000-006	684		
773-492	620	793-501	684				
773-493	620						
773-494	620						

Item No.	Page	Item No.	Page	Item No.	Page	Item No.	Page
821 Series		862 Series		869 Series		869 Series	
821-104	272	862-1625	561	869-105	527	869-339	528
821-106	272	862-1625/999-950	561	869-106	527	869-341	528
821-107	272	862-1632	558	869-107	527	869-344	528
821-108	273	862-1632/999-950	558	869-108	527	869-347	528
821-109	273	862-1633	559	869-109	527	869-349	528
821-110	274	862-1633/999-950	559	869-110	527	869-351	528
821-111	274	862-1634	560	869-111	527	869-354	528
821-112	275	862-1634/999-950	560	869-112	527	869-357	528
821-113	275	862-1652	558	869-132	527	869-359	528
821-122	273	862-1652/999-950	558	869-133	527	869-375	528
821-123	274	862-1662	558	869-134	527	869-377	528
821-129	275	862-1662/999-950	558	869-135	527	869-378	528
821-153	69	862-1693	559	869-136	527	869-379	528
821-154	69	862-1693/999-950	559	869-137	527	869-385	528
821-155	69	862-1694	560	869-138	527	869-387	528
821-160	276	862-1694/999-950	560	869-139	527	869-388	528
821-161	276	862-2503	559	869-140	527	869-389	528
821-162	276	862-2504	560	869-141	527	869-395	528
859 Series		862-2505	561	869-142	527	869-397	528
859-500	194	862-2515	561	869-152	527	869-398	528
862 Series		862-2525	561	869-153	527	869-399	528
862-482	558	862-2532	558	869-154	527	870 Series	
862-503	559	862-2533	559	869-155	527	870-101	466
862-504	560	862-2534	560	869-156	527	870-102	466
862-505	561	862-2552	558	869-157	527	870-103	466
862-515	561	862-2562	558	869-158	527	870-104	466
862-525	561	862-2593	559	869-159	527	870-107	466
862-532	558	862-2594	560	869-160	527	870-108	466
862-533	559	862-2603	559	869-161	527	870-109	466
862-534	560	862-2604	560	869-162	527	870-117	466
862-552	558	862-2605	561	869-182	527	870-118	466
862-562	558	862-2615	561	869-183	527	870-119	466
862-593	559	862-2625	561	869-184	527	870-127	466
862-594	560	862-2632	558	869-185	527	870-131	472
862-603	559	862-2633	559	869-186	527	870-137	472
862-604	560	862-2634	560	869-187	527	870-138	472
862-605	561	862-2652	558	869-188	527	870-148	472
862-615	561	862-2662	558	869-189	527	870-149	472
862-625	561	862-2693	559	869-190	527	870-151	470
862-632	558	862-2694	560	869-191	527	870-157	470
862-633	559	862-8503	559	869-192	527	870-158	470
862-634	560	862-8504	560	869-202	527	870-168	470
862-652	558	862-8505	561	869-203	527	870-169	470
862-662	558	862-8515	561	869-204	527	870-182	513
862-693	559	862-8525	561	869-205	527	870-183	513
862-694	560	862-8533	559	869-206	527	870-184	513
862-1503	559	862-8534	560	869-207	527	870-184	529
862-1503/999-950	559	862-8593	559	869-208	527	870-402	466
862-1504	560	862-8594	560	869-209	527	870-403	466
862-1504/999-950	560	862-8603	559	869-210	527	870-404	466
862-1505	561	862-8604	560	869-211	527	870-405	466
862-1505/999-950	561	862-8605	561	869-212	527	870-405/011-000	513
862-1515	561	862-8615	561	869-232	527	870-406	466
862-1515/999-950	561	862-8625	561	869-233	527	870-406/020-000	513
862-1525	561	862-8633	559	869-234	527	870-407	466
862-1525/999-950	561	862-8634	560	869-235	527	870-407/011-000	513
862-1532	558	862-8693	559	869-236	527	870-408	466
862-1532/999-950	558	862-8694	560	869-237	527	870-409	466
862-1533	559	862-9503	559	869-238	527	870-409/011-000	513
862-1533/999-950	559	862-9504	560	869-239	527	870-410	466
862-1534	560	862-9505	561	869-240	527	870-425	509
862-1534/999-950	560	862-9515	561	869-241	527	870-426	519
862-1552	558	862-9525	561	869-242	527	870-427	519
862-1552/999-950	558	862-9533	559	869-301	528	870-433	466
862-1562	558	862-9534	560	869-304	528	870-434	466
862-1562/999-950	558	862-9593	559	869-307	528	870-435	466
862-1593	559	862-9594	560	869-309	528	870-436	466
862-1593/999-950	559	862-9603	559	869-311	529	870-437	466
862-1594	560	862-9604	560	869-314	529	870-438	466
862-1594/999-950	560	862-9605	561	869-316	529	870-439	466
862-1603	559	862-9615	561	869-317	529	870-440	466
862-1603/999-950	559	862-9625	561	869-319	529	870-501	510
862-1604	560	862-9633	559	869-321	528	870-502	510
862-1604/999-950	560	862-9634	560	869-324	528	870-504	510
862-1605	561	862-9693	559	869-326	528	870-507	510
862-1605/999-950	561	862-9694	560	869-327	528	870-508	510
862-1615	561	869 Series		869-328	528	870-509	510
862-1615/999-950	561	869-102	527	869-329	528	870-517	510
		869-103	527	869-331	528		
		869-104	527	869-334	528		
				869-337	528		

Item Number Index

Item No.	Page	Item No.	Page	Item No.	Page	Item No.	Page
870 Series		870 Series		2000 Series		2000 Series	
870-518	510	870-1131	468	2000-438	36	2000-2247/099-000	74
870-519	510	870-1137	468	2000-439	36	2000-2248	73
870-527	510	870-1138	468	2000-440	36	2000-2248/099-000	75
870-531	511	870-1148	468	2000-492	73	2000-2257	72
870-532	511	870-1149	468	2000-510	36	2000-2257/099-000	74
870-533	511			2000-511	36	2000-2258	73
870-534	511			2000-549	36	2000-2258/099-000	75
870-535	511	873 Series		2000-552	176	2000-2291	73
870-536	511	873-902	662	2000-553	176	2000-2292	73
870-537	511	873-903	662	2000-554	176	2000-5310/101-000	149
870-538	511	873-953	663	2000-555	176	2000-5310/102-000	149
870-539	511			2000-556	176	2000-5310/1101-951	149
870-540/281-410	514	887 Series		2000-557	176	2000-5310/1102-950	149
870-540/281-411	514	887-802	659	2000-558	176	2000-5311	146
870-541/281-489	514	887-803	660	2000-559	176	2000-5311/1101-951	146
870-541/281-490	514	887-804	660	2000-560	176	2000-5311/1102-950	146
870-541/281-491	514	887-805	660	2000-1201	52	2000-5317/101-000	148
870-541/281-492	514	887-804	660	2000-1202	52	2000-5317/102-000	148
870-542/281-487	514	887-805	660	2000-1203	52	2000-5317/1101-951	148
870-542/281-488	514	887-851	660	2000-1204	52	2000-5317/1102-950	148
870-543/281-413	514	887-852	660	2000-1205	52	2000-5352	146
870-543/281-434	514	887-853	660	2000-1206	52	2000-5352/1102-953	146
870-551	512	887-910	658	2000-1207	52	2000-5357/101-000	148
870-553	512	887-912	658	2000-1291	36	2000-5357/102-000	148
870-556	512	887-925	658	2000-1302	52	2000-5372	146
870-557	512	887-926	659	2000-1303	52	2000-5372/1102-953	146
870-558	512	887-927	658	2000-1304	52	2000-5377/101-000	148
870-559	512	887-927	659	2000-1305	52	2000-5377/102-000	148
870-567	512	887-928	658	2000-1306	52	2000-5391	146
870-568	512	887-928	659	2000-1307	52	2000-5410	149
870-569	512	887-931	659	2000-1391	36	2000-5410/1101-951	149
870-573	511	887-932	659	2000-1392	36	2000-5410/1102-950	149
870-574	511	887-934	658	2000-1401	52	2000-5417	147
870-574/281-483	521	887-952	661	2000-1402	52	2000-5417/1101-951	147
870-577	512	887-953	661	2000-1403	52	2000-5417/1102-950	147
870-590/281-410	516	887-955	660	2000-1404	52	2000-5457	147
870-590/281-411	516	887-957	660	2000-1405	52	2000-5457/1102-953	147
870-590/281-675	516	887-959	661	2000-1406	52	2000-5477	147
870-590/281-676	516	887-960	661	2000-1407	52	2000-5477/1102-953	147
870-593/281-413	516			2000-1491	36	2000-5491	147
870-593/281-434	516			2000-1492	36		
870-596/281-673	516	2000 Series		2000-2141	53	2001 Series	
870-596/281-674	516	2000-115	52	2000-2195	52	2001-115	54
870-681	508	2000-121	691	2000-2196	52	2001-171	38
870-682	508	2000-402	36	2000-2201	72	2001-402	38
870-684	508	2000-402/000-005	182	2000-2201/099-000	74	2001-403	38
870-687	508	2000-402/000-006	182	2000-2202	72	2001-404	38
870-826	509	2000-402/000-018	182	2000-2202/099-000	74	2001-405	38
870-831	508	2000-403	36	2000-2203	72	2001-405/011-000	38
870-832	508	2000-403/000-005	182	2000-2203/099-000	74	2001-406	38
870-834	508	2000-403/000-006	182	2000-2204	72	2001-406/020-000	38
870-837	508	2000-404	36	2000-2204/099-0003	74	2001-407	38
870-901	508	2000-404/000-005	182	2000-2207	72	2001-408	38
870-902	508	2000-404/000-006	182	2000-2207/099-000	74	2001-409	38
870-904	508	2000-405	36	2000-2208	72	2001-410	38
870-907	508	2000-405/000-005	182	2000-2208/099-000	74	2001-433	38
870-907/999-950	508	2000-405/000-006	182	2000-2209	72	2001-434	38
870-909	508	2000-405/011-000	185	2000-2209/099-0003	74	2001-435	38
870-911	509	2000-406	36	2000-2217	72	2001-436	38
870-912	509	2000-406/000-005	182	2000-2217/099-000	74	2001-437	38
870-914	509	2000-406/000-006	182	2000-2218	73	2001-438	38
870-917	508	2000-406/020-000	36	2000-2218/099-000	75	2001-439	38
870-919	508	2000-407	36	2000-2227	72	2001-440	38
870-923	508	2000-407/000-005	182	2000-2227/099-000	74	2001-511	38
870-924	508	2000-407/000-006	182	2000-2228	73	2001-549	55
870-925	508	2000-408	36	2000-2228/099-000	75	2001-552	176
870-926	508	2000-408/000-005	182	2000-2231	72	2001-553	176
870-928	508	2000-408/000-006	182	2000-2231/099-000	74	2001-554	176
870-929	508	2000-409	36	2000-2232	72	2001-555	176
870-933	508	2000-409/000-005	182	2000-2232/099-000	74	2001-556	176
870-934	508	2000-409/000-006	182	2000-2233	72	2001-557	176
870-943	508	2000-410	36	2000-2233/099-000	74	2001-558	176
870-944	508	2000-410/000-005	182	2000-2234	72	2001-559	176
870-946	508	2000-410/000-006	182	2000-2234/099-0003	74	2001-560	176
870-947	508	2000-433	36	2000-2237	72	2001-1201	54
870-948	508	2000-433/000-005	182	2000-2237/099-000	74	2001-1201/000-053	54
870-949	508	2000-433/000-006	182	2000-2238	72	2001-1202	54
870-951	512	2000-434	36	2000-2238/099-000	74	2001-1203	54
870-957/999-950	512	2000-435	36	2000-2239	72	2001-1204	54
870-961	510	2000-436	36	2000-2239/099-0003	74	2001-1205	54
870-967/999-950	510	2000-437	36	2000-2247	72	2001-1206	54

Item Number Index

Item No.	Page	Item No.	Page	Item No.	Page	Item No.	Page
2002 Series		2002 Series		2003 Series		2004 Series	
2002-2291	77	2002-3208	90	2003-7640	256	2004-1491	44
2002-2292	77	2002-3209	90	2003-7641	256	2004-1492	44
2002-2295	77	2002-3211/1000-410	174	2003-7642	256	2004-1493	60
2002-2296	77	2002-3211/1000-411	174	2003-7645	256	2004-1494	44
2002-2401	82	2002-3211/1000-675	174	2003-7646	256	2005 Series	
2002-2402	82	2002-3211/1000-676	174	2003-7649	256	2005-7300	246
2002-2403	82	2002-3212/1000-673	174	2003-7650	256	2005-7641	264
2002-2404	82	2002-3212/1000-674	174	2003-7651	256	2005-7642	264
2002-2407	82	2002-3217	90	2003-7659	256	2005-7645	264
2002-2408	82	2002-3218	91	2003-7692	256	2005-7646	264
2002-2409	82	2002-3221/1000-413	174	2004 Series		2005-7649	264
2002-2417	82	2002-3221/1000-434	174	2004-115	27	2005-7692	264
2002-2418	83	2002-3227	90	2004-171	27	2006 Series	
2002-2427	82	2002-3228	91	2004-172	27	2006-115	28
2002-2428	83	2002-3231	90	2004-402	27	2006-191	28
2002-2431	82	2002-3233	90	2004-403	44	2006-401	188
2002-2432	82	2002-3234	90	2004-404	44	2006-401/000-050	188
2002-2433	82	2002-3237	90	2004-405	27	2006-402	28
2002-2434	82	2002-3238	90	2004-405/011-000	27	2006-403	28
2002-2437	82	2002-3239	90	2004-406	27	2006-404	28
2002-2438	82	2002-3247	90	2004-406/020-000	27	2006-405	28
2002-2439	82	2002-3248	91	2004-407	27	2006-405/011-000	185
2002-2447	82	2002-3257	90	2004-408	27	2006-433	28
2002-2448	83	2002-3258	91	2004-409	27	2006-434	28
2002-2457	82	2002-3291	91	2004-410	27	2006-435	28
2002-2458	83	2002-3292	91	2004-433	27	2006-451	188
2002-2491	83	2002-4101	92	2004-434	27	2006-499	38
2002-2492	83	2002-4111	92	2004-435	27	2006-511	28
2002-2601	84	2002-4127	92	2004-436	27	2006-549	28
2002-2602	84	2002-4131	92	2004-437	27	2006-911	142
2002-2603	84	2002-4141	92	2004-438	27	2006-911/1000-541	142
2002-2604	84	2002-4157	92	2004-439	27	2006-911/1000-542	142
2002-2607	84	2002-4191	92	2004-440	27	2006-911/1000-836	142
2002-2608	84	2002-4192	92	2004-511	178	2006-921	142
2002-2609	84	2002-6301	58	2004-541	178	2006-921/1000-541	142
2002-2611	85	2002-6302	58	2004-549	178	2006-921/1000-542	142
2002-2611/1000-541	87	2002-6303	58	2004-552	178	2006-921/1000-836	142
2002-2611/1000-542	87	2002-6304	58	2004-553	178	2006-921/1000-836	142
2002-2611/1000-836	87	2002-6305	58	2004-554	178	2006-921/1000-859	142
2002-2611/1000-867	87	2002-6306	58	2004-555	178	2006-931	142
2002-2612	87	2002-6307	58	2004-911	140	2006-931/099-000	142
2002-2647	84	2002-6308	58	2004-911/1000-541	140	2006-931/1000-541	142
2002-2657	84	2002-6391	42	2004-911/1000-542	140	2006-931/1000-836	142
2002-2661	86	2002-6392	42	2004-911/1000-836	140	2006-931/1000-859	142
2002-2662	86	2002-6401	59	2004-911/1000-867	140	2006-931/1000-867	142
2002-2667	86	2002-6402	59	2004-1201	60	2006-931/1099-541	143
2002-2671	86	2002-6403	59	2004-1202	60	2006-931/1099-542	143
2002-2672	86	2002-6404	59	2004-1203	60	2006-931/1099-836	143
2002-2678	86	2002-6405	59	2004-1204	60	2006-931/1099-859	143
2002-2691	85	2002-6406	59	2004-1205	60	2006-991	122
2002-2692	85	2002-6407	59	2004-1206	60	2006-992	122
2002-2701	81	2002-7111	268	2004-1207	60	2006-1201	62
2002-2702	81	2002-7114	268	2004-1211/1000-400	158	2006-1202	62
2002-2703	81	2002-7192	268	2004-1211/1000-401	158	2006-1203	62
2002-2704	81	2002-7211	268	2004-1291	44	2006-1204	62
2002-2707	81	2002-7214	268	2004-1292	44	2006-1207	62
2002-2707/999-950	81	2002-7292	268	2004-1293	60	2006-1208	62
2002-2708	81	2003 Series		2004-1294	60	2006-1291	46
2002-2709	81	2003-499	242	2004-1302	60	2006-1292	46
2002-2717	81	2003-500	242	2004-1303	60	2006-1293	46
2002-2727	81	2003-911	262	2004-1304	60	2006-1294	46
2002-2731	81	2003-911/1000-923	262	2004-1305	60	2006-1301	62
2002-2791	70	2003-6640	260	2004-1306	60	2006-1302	62
2002-2792	70	2003-6641	258	2004-1307	60	2006-1303	62
2002-2941	170	2003-6642	258	2004-1311/1000-400	158	2006-1304	62
2002-2951	168	2003-6643	260	2004-1311/1000-401	158	2006-1305	62
2002-2952	168	2003-6644	258	2004-1391	44	2006-1306	62
2002-2954	168	2003-6645	258	2004-1392	44	2006-1307	62
2002-2958	168	2003-6646	258	2004-1393	44	2006-1391	46
2002-2959	168	2003-6649	258	2004-1394	44	2006-1392	46
2002-2961	140	2003-6649	258	2004-1401	60	2006-1393	46
2002-2963	140	2003-6650	258	2004-1402	60	2006-1394	46
2002-2971	168	2003-6651	258	2004-1403	60	2006-1601	125
2002-2972	168	2003-6660	260	2004-1404	60	2006-1604	125
2002-2974	168	2003-6661	260	2004-1405	60	2006-1611	128
2002-2991	140	2003-6662	260	2004-1406	60	2006-1611/1000-541	128
2002-2992	140	2003-6662	260	2004-1407	60	2006-1611/1000-542	128
2002-3201	90	2003-6692	258	2004-1408	60	2006-1611/1000-836	128
2002-3203	90	2003-6693	260	2004-1409	60	2006-1611/1000-867	128
2002-3204	90	2003-6694	260	2004-1411/1000-400	158		
2002-3207	90	2003-7300	240	2004-1411/1000-401	158		

Item Number Index

Item No.	Page	Item No.	Page	Item No.	Page	Item No.	Page
2020 Series		2020 Series		2022 Series		2022 Series	
2020-203/132-000	208	2020-213/145-000	208	2022-101/132-016	224	2022-110/135-000	224
2020-203/142-000	208	2020-214	198	2022-101/142-000	224	2022-110/145-000	224
2020-204	198	2020-214/000-036	204	2022-101/142-006	224	2022-111	218
2020-204/000-036	204	2020-214/000-037	204	2022-101/142-016	224	2022-111/000-036	222
2020-204/000-037	204	2020-214/000-038	204	2022-102	218	2022-111/000-037	222
2020-204/000-038	204	2020-214/000-039	205	2022-102/122-000	224	2022-111/000-038	222
2020-204/000-039	205	2020-214/125-000	208	2022-102/132-000	224	2022-111/000-039	223
2020-204/124-000	208	2020-214/135-000	208	2022-102/142-000	224	2022-111/126-000	224
2020-204/133-000	208	2020-214/145-000	208	2022-102/999-953	234	2022-111/136-000	224
2020-204/143-000	208	2020-215	198	2022-103	218	2022-111/146-000	224
2020-205	198	2020-215/000-036	204	2022-103/000-036	222	2022-112	218
2020-205/000-036	204	2020-215/000-037	204	2022-103/000-037	222	2022-112/000-036	222
2020-205/000-037	204	2020-215/000-038	204	2022-103/000-038	222	2022-112/000-037	222
2020-205/000-038	204	2020-215/000-039	205	2022-103/000-038/999-953	235	2022-112/000-038	222
2020-205/000-039	205	2020-215/125-000	208	2022-103/000-039	223	2022-112/000-039	223
2020-205/124-000	208	2020-215/135-000	208	2022-103/123-000	224	2022-112/126-000	224
2020-205/133-000	208	2020-215/145-000	208	2022-103/133-000	224	2022-112/136-000	224
2020-205/143-000	208	2020-261	200	2022-103/143-000	224	2022-112/146-000	224
2020-206	198	2020-264	200	2022-103/999-953	234	2022-113	218
2020-206/000-036	204	2020-267	200	2022-104	218	2022-113/000-036	222
2020-206/000-037	204	2020-281	200	2022-104/000-036	222	2022-113/000-037	222
2020-206/000-038	204	2020-284	200	2022-104/000-037	222	2022-113/000-038	222
2020-206/000-039	205	2020-287	200	2022-104/000-038	222	2022-113/000-039	223
2020-206/124-000	208	2020-1201	194	2022-104/000-038/999-953	235	2022-113/126-000	224
2020-206/133-000	208	2020-1204	194	2022-104/000-039	223	2022-113/136-000	224
2020-206/143-000	208	2020-1207	194	2022-104/123-000	224	2022-113/146-000	224
2020-207	198	2020-1291	194	2022-104/133-000	224	2022-114	218
2020-207/000-036	204	2020-1292	194	2022-104/143-000	224	2022-114/000-036	222
2020-207/000-037	204	2020-1301	194	2022-104/999-953	234	2022-114/000-037	222
2020-207/000-038	204	2020-1304	194	2022-105	218	2022-114/000-038	222
2020-207/000-039	205	2020-1307	194	2022-105/000-036	222	2022-114/000-039	223
2020-207/124-000	208	2020-1391	194	2022-105/000-037	222	2022-114/126-000	224
2020-207/134-000	208	2020-1392	194	2022-105/000-038	222	2022-114/136-000	224
2020-207/144-000	208	2020-1401	194	2022-105/000-038/999-953	235	2022-114/146-000	224
2020-208	198	2020-1404	194	2022-105/000-039	223	2022-115	218
2020-208/000-036	204	2020-1407	194	2022-105/123-000	224	2022-115/000-036	222
2020-208/000-037	204	2020-1491	194	2022-105/134-000	224	2022-115/000-037	222
2020-208/000-038	204	2020-1492	194	2022-105/144-000	224	2022-115/000-038	222
2020-208/000-039	205	2020-2201	196	2022-105/999-953	234	2022-115/000-039	223
2020-208/124-000	208	2020-2202	196	2022-106	218	2022-115/127-000	224
2020-208/134-000	208	2020-2203	196	2022-106/000-036	222	2022-115/137-000	224
2020-208/144-000	208	2020-2204	196	2022-106/000-037	222	2022-115/147-000	224
2020-209	198	2020-2207	196	2022-106/000-038	222	2022-141	198
2020-209/000-036	204	2020-2208	196	2022-106/000-038/999-953	235	2022-142	198
2020-209/000-037	204	2020-2209	196	2022-106/000-039	223	2022-151	198
2020-209/000-038	204	2020-2217	196	2022-106/123-000	224	2022-152	198
2020-209/000-039	205	2020-2227	196	2022-106/134-000	224	2022-161	220
2020-209/124-000	208	2020-2231	196	2022-106/144-000	224	2022-162	220
2020-209/134-000	208	2020-2232	196	2022-106/999-953	234	2022-164	220
2020-209/144-000	208	2020-2233	196	2022-107	218	2022-167	220
2020-210	198	2020-2234	196	2022-107/000-036	222	2022-171	220
2020-210/000-036	204	2020-2237	196	2022-107/000-037	222	2022-172	220
2020-210/000-037	204	2020-2238	196	2022-107/000-038	222	2022-174	220
2020-210/000-038	204	2020-2239	196	2022-107/000-039	223	2022-177	220
2020-210/000-039	205	2020-2247	196	2022-107/123-000	224	2022-181	220
2020-210/125-000	208	2020-2257	196	2022-107/135-000	224	2022-182	220
2020-210/135-000	208	2020-2291	197	2022-107/145-000	224	2022-184	220
2020-210/145-000	208	2020-2292	197	2022-107/999-953	234	2022-187	220
2020-211	198	2020-5311	151	2022-108	218	2022-1201	212
2020-211/000-036	204	2020-5311/1102-950	151	2022-108/000-036	222	2022-1201/999-953	228
2020-211/000-037	204	2020-5317/102-000	153	2022-108/000-037	222	2022-1202	212
2020-211/000-038	204	2020-5317/1102-950	153	2022-108/000-038	222	2022-1204	212
2020-211/000-039	205	2020-5372	151	2022-108/000-039	223	2022-1204/999-953	228
2020-211/125-000	208	2020-5372/1102-953	151	2022-108/123-000	224	2022-1207	212
2020-211/135-000	208	2020-5377/102-000	153	2022-108/135-000	224	2022-1207/999-953	228
2020-211/145-000	208	2020-5391	151	2022-108/145-000	224	2022-1291	210
2020-212	198	2020-5417	152	2022-108/999-953	234	2022-1292	210
2020-212/000-036	204	2020-5417/1102-950	152	2022-109	218	2022-1301	212
2020-212/000-037	204	2020-5477	152	2022-109/000-036	222	2022-1301/999-953	228
2020-212/000-038	204	2020-5477/1102-953	152	2022-109/000-037	222	2022-1302	212
2020-212/000-039	205	2020-5491	152	2022-109/000-038	222	2022-1304	212
2020-212/125-000	208			2022-109/000-039	223	2022-1304/999-953	228
2020-212/135-000	208			2022-109/123-000	224	2022-1307	212
2020-212/145-000	208			2022-109/135-000	224	2022-1307/999-953	228
2020-213	198	2022 Series		2022-109/145-000	224	2022-1391	210
2020-213/000-036	204	2022-100	210	2022-110	218	2022-1392	210
2020-213/000-037	204	2022-101	210	2022-110/000-036	222	2022-1401	212
2020-213/000-038	204	2022-101/122-000	224	2022-110/000-037	222	2022-1401/999-953	228
2020-213/000-039	205	2022-101/122-006	224	2022-110/000-038	222	2022-1402	212
2020-213/125-000	208	2022-101/122-016	224	2022-110/000-039	223	2022-1404	212
2020-213/135-000	208	2022-101/132-000	224	2022-110/123-000	224	2022-1404/999-953	228
		2022-101/132-006	224				

Item No.	Page	Item No.	Page	Item No.	Page	Item No.	Page
2022 Series		2050 Series		2104 Series		2201 Series	
2022-1407	212	2050-321/000-014	290	2104-5307	32	2201-1302/000-053	38
2022-1407/999-953	228	2050-322	290			2201-1304	38
2022-1491	210	2050-323	290			2201-1307	38
2022-1492	210	2050-324	290	2106 Series		2201-1401	38
2022-1601	214	2050-325	290	2106-1201	28	2201-1401/000-053	38
2022-1601/999-953	230	2050-326	290	2106-1204	28	2201-1402/000-053	38
2022-1604	214	2050-327	290	2106-1207	28	2201-1404	38
2022-1604/999-953	230	2050-381	286	2106-1291	28	2201-1407	38
2022-1607	214			2106-1292	28		
2022-1607/999-953	230	2052 Series		2106-1301	28	2202 Series	
2022-1691	214	2052-301	292	2106-1304	28	2202-1201	40
2022-1692	214	2052-301/000-014	292	2106-1307	28	2202-1202	40
2022-1801	214	2052-302	292	2106-1391	28	2202-1203	40
2022-1801/999-953	230	2052-303	292	2106-1392	28	2202-1204	40
2022-1804	214	2052-304	292	2106-5201	33	2202-1205	40
2022-1804/999-953	230	2052-305	292	2106-5204	33	2202-1206	40
2022-1807	214	2052-306	292	2106-5207	33	2202-1207	40
2022-1807/999-953	230	2052-307	292	2106-5301	33	2202-1209	40
2022-1891	214	2052-311	293	2106-5304	33	2202-1301	40
2022-1892	214	2052-311/000-014	293	2106-5307	33	2202-1302	40
2022-2201	216	2052-312	293			2202-1303	40
2022-2201/999-953	232	2052-313	293	2110 Series		2202-1304	40
2022-2202	216	2052-314	293	2110-1201	29	2202-1305	40
2022-2202/999-953	232	2052-315	293	2110-1204	29	2202-1306	40
2022-2203	216	2052-316	293	2110-1207	29	2202-1307	40
2022-2203/999-953	232	2052-317	293	2110-1291	29	2202-1309	40
2022-2204	216	2052-321	292	2110-1292	29	2202-1401	40
2022-2204/999-953	232	2052-321/000-014	292	2110-1301	29	2202-1402	40
2022-2207	216	2052-322	292	2110-1304	29	2202-1403	40
2022-2207/999-953	232	2052-323	292	2110-1307	29	2202-1404	40
2022-2208	216	2052-324	292	2110-1391	29	2202-1405	40
2022-2208/999-953	232	2052-325	292	2110-1392	29	2202-1406	40
2022-2209	216	2052-326	292	2110-5201	34	2202-1407	40
2022-2209/999-953	232	2052-327	292	2110-5204	34	2202-1409	40
2022-2217	216	2052-381	288	2110-5207	34	2202-1601	95
2022-2217/999-953	232	2052-391	289	2110-5301	34	2202-1602	95
2022-2227	216	2052-1201	285	2110-5304	34	2202-1604	95
2022-2227/999-953	232	2052-1201/000-014	285	2110-5307	34	2202-1611	104
2022-2231	216	2052-1202	285			2202-1611/1000-541	104
2022-2231/999-953	232	2052-1203	285	2116 Series		2202-1611/1000-542	104
2022-2232	216	2052-1204	285	2116-1201	30	2202-1611/1000-836	104
2022-2232/999-953	232	2052-1205	285	2116-1201/605-038	30	2202-1611/1000-867	104
2022-2233	216	2052-1206	285	2116-1204	30	2202-1661	94
2022-2233/999-953	232	2052-1207	285	2116-1207	30	2202-1671	94
2022-2234	216	2052-1291	283	2116-1291	30	2202-1672	94
2022-2234/999-953	232			2116-1292	30	2202-1674	94
2022-2237	216	2102 Series		2116-1301	30	2202-1681	94
2022-2237/999-953	232	2102-1201	26	2116-1304	30	2202-1701	97
2022-2238	216	2102-1204	26	2116-1307	30	2202-1702	97
2022-2238/999-953	232	2102-1207	26	2116-1391	30	2202-1704	97
2022-2239	216	2102-1291	26	2116-1392	30	2202-1707	97
2022-2239/999-953	232	2102-1292	26	2116-5201	35	2202-1711	104
2022-2247	216	2102-1301	26	2116-5204	35	2202-1711/1000-541	104
2022-2247/999-953	232	2102-1304	26	2116-5207	35	2202-1711/1000-542	104
2022-2257	216	2102-1307	26	2116-5301	35	2202-1711/1000-836	104
2022-2257/999-953	232	2102-1391	26	2116-5304	35	2202-1711/1000-867	104
2022-2291	217	2102-1392	26	2116-5307	35	2202-1761	96
2022-2292	217	2102-5201	31			2202-1771	96
		2102-5204	31	2200 Series		2202-1772	96
2042 Series		2102-5207	31	2200-1201	36	2202-1774	96
2042-321	166	2102-5301	31	2200-1204	36	2202-1781	96
		2102-5304	31	2200-1207	36	2202-1801	99
		2102-5307	31	2200-1301	36	2202-1802	99
2050 Series		2104 Series		2200-1304	36	2202-1804	99
2050-301	290	2104-1201	27	2200-1307	36	2202-1811	105
2050-301/000-014	290	2104-1204	27	2200-1401	36	2202-1811/1000-541	105
2050-302	290	2104-1207	27	2200-1404	36	2202-1811/1000-542	105
2050-303	290	2104-1291	27	2200-1407	36	2202-1811/1000-836	105
2050-304	290	2104-1292	27			2202-1861	98
2050-305	290	2104-1301	27	2201 Series		2202-1871	98
2050-306	290	2104-1304	27	2201-1201	38	2202-1872	98
2050-307	290	2104-1307	27	2201-1201/000-053	38	2202-1874	98
2050-311	291	2104-1391	27	2201-1204	38	2202-1881	98
2050-311/000-014	291	2104-1392	27	2201-1207	38	2202-1901	101
2050-312	291	2104-5201	32	2201-1207	38	2202-1902	101
2050-313	291	2104-5204	32	2201-1301	38	2202-1904	101
2050-314	291	2104-5207	32	2201-1301/000-053	38	2202-1907	100
2050-315	291	2104-5301	32	2201-1302	38	2202-1911	104
2050-316	291	2104-5304	32			2202-1911/1000-541	104
2050-317	291					2202-1911/1000-542	104
2050-321	290						

Item Number Index

Item No.	Page	Item No.	Page	Item No.	Page	Item No.	Page
2202 Series		2203 Series		2206 Series		2222 Series	
2202-1911/1000-836	104	2203-6651	250	2206-1612	122	2222-1202/999-953	226
2202-1911/1000-867	104	2203-6660	252	2206-1615	122	2222-1204	210
2202-1961	100	2203-6661	252	2206-1621	122	2222-1204/999-953	226
2202-1971	100	2203-6692	242	2206-1621/1000-541	122	2222-1207	210
2202-1972	100	2203-6693	244	2206-1621/1000-542	122	2222-1207/999-953	226
2202-1974	100	2203-6693	252	2206-1621/1000-836	122	2222-1301	210
2202-1981	103	2203-6694	244	2206-1621/1000-859	122	2222-1301/999-953	226
2202-1981/1000-413	102	2203-7540	240	2206-1621/1000-867	122	2222-1302	210
2202-1981/1000-414	102	2203-7541	240	2206-1622	122	2222-1302/999-953	226
2202-1981/1000-429	102	2203-7542	240	2206-1624	122	2222-1304	210
2202-1981/1000-434	102	2203-7545	240	2206-1631	122	2222-1304/999-953	226
2202-1981/1000-435	102	2203-7546	240	2206-1631/099-000	123	2222-1307	210
2202-1981/1000-449	102	2203-7549	240	2206-1631/1000-541	122	2222-1307/999-953	226
2202-2701	70	2203-7550	240	2206-1631/1000-542	122	2222-1401	210
2202-2702	70	2203-7551	240	2206-1631/1000-836	122	2222-1401/999-953	226
2202-2703	70	2203-7559	240	2206-1631/1000-859	122	2222-1402	210
2202-2704	70	2203-7640	248	2206-1631/1000-867	122	2222-1402/999-953	226
2202-2707	70	2203-7641	248	2206-1631/1099-541	123	2222-1404	210
2202-2708	70	2203-7642	248	2206-1631/1099-542	123	2222-1404/999-953	226
2202-2709	70	2203-7645	248	2206-1631/1099-836	123	2222-1407	210
2202-2717	70	2203-7646	248	2206-1631/1099-859	123	2222-1407/999-953	226
2202-2727	70	2203-7649	248	2206-1631/1099-867	123		
2202-2731	70	2203-7650	248	2206-1661	118	2250 Series	
2202-3201	88	2203-7651	248	2206-1662	118	2250-301	286
2202-3203	88	2203-7659	248	2206-1663	118	2250-301/000-014	286
2202-3204	88	2203-7692	240	2206-1664	118	2250-302	286
2202-3207	88			2206-1671	118	2250-303	286
2202-3208	88	2204 Series		2206-1671/1000-848	118	2250-304	286
2202-3209	88	2204-1201	44	2206-1671/1000-849	118	2250-305	286
2202-3217	88	2204-1202	44	2206-1671/1000-850	118	2250-306	286
2202-3218	89	2204-1203	44	2206-1671/1000-851	118	2250-307	286
2202-3227	88	2204-1204	44	2206-1672	118	2250-311	287
2202-3228	89	2204-1205	44	2206-1673	118	2250-311/000-014	287
2202-3231	88	2204-1206	44	2206-1674	118	2250-312	287
2202-3233	88	2204-1207	44	2206-1675	118	2250-313	287
2202-3234	88	2204-1209	44	2206-1681	121	2250-314	287
2202-3237	88	2204-1301	44	2206-1681/1000-413	120	2250-315	287
2202-3238	88	2204-1302	44	2206-1681/1000-414	120	2250-316	287
2202-3239	88	2204-1303	44	2206-1681/1000-429	120	2250-317	287
2202-3247	88	2204-1304	44	2206-1681/1000-434	120	2250-321	286
2202-3248	89	2204-1305	44	2206-1681/1000-435	120	2250-321/000-014	286
2202-3257	88	2204-1306	44	2206-1681/1000-449	120	2250-322	286
2202-3258	89	2204-1307	44	2206-7111	266	2250-323	286
2202-6301	42	2204-1309	44	2206-7114	266	2250-324	286
2202-6302	42	2204-1401	44	2206-8031	66	2250-325	286
2202-6303	42	2204-1402	44	2206-8031/000-053	66	2250-326	286
2202-6304	42	2204-1403	44	2206-8033	66	2250-327	286
2202-6305	42	2204-1404	44	2206-8034	66	2250-1201	282
2202-6306	42	2204-1405	44	2206-8035	66	2250-1201/000-014	282
2202-6307	42	2204-1406	44			2250-1202	282
2202-6401	43	2204-1407	44	2210 Series		2250-1203	282
2202-6402	43	2204-1409	44	2210-1201	47	2250-1204	282
2202-6403	43			2210-1203	47	2250-1205	282
2202-6404	43	2205 Series		2210-1204	47	2250-1206	282
2202-6405	43	2205-7541	246	2210-1205	47	2250-1207	282
2202-6406	43	2205-7542	246	2210-1207	47	2252 Series	
2202-6407	43	2205-7545	246	2210-1301	47	2252-301	288
		2205-7546	246	2210-1303	47	2252-301/000-014	288
		2205-7549	246	2210-1304	47	2252-302	288
		2205-7641	254	2210-1305	47	2252-303	288
		2205-7642	254	2210-1307	47	2252-304	288
		2205-7645	254	2216 Series		2252-305	288
		2205-7646	254	2216-1201	48	2252-306	288
		2205-7649	254	2216-1203	48	2252-307	288
		2205-7692	246	2216-1204	48	2252-311	289
				2216-1205	48	2252-311/000-014	289
				2216-1207	48	2252-312	289
				2216-1301	48	2252-313	289
				2216-1303	48	2252-314	289
				2216-1304	48	2252-315	289
				2216-1305	48	2252-316	289
				2216-1307	48	2252-317	289
				2216-7111	266	2252-321	288
				2216-7114	266	2252-321/000-014	288
				2222 Series		2252-322	288
				2222-1201	210	2252-323	288
				2222-1201/999-953	226	2252-324	288
				2222-1202	210	2252-326	288
						2252-327	288

Item No.	Page	Item No.	Page	Item No.	Page	Item No.	Page
2252 Series							
2252-1201	283						
2252-1201/000-014	283						
2252-1202	283						
2252-1203	283						
2252-1204	283						
2252-1205	283						
2252-1206	283						
2252-1207	283						
2273 Series							
2273-202	615						
2273-203	615						
2273-204	615						
2273-205	615						
2273-208	615						
2273-500	615						

Success for Generations: Environmental Protection at WAGO



At WAGO, we see environmental protection not only as compliance with environmental protection requirements.

As a growing company, our commitment to the environment drives our efforts to deliver new ideas, new concepts and new technologies along the product lifecycle. Here our employees and business partners support us.

Corporate Environmental Protection

Business growth also leads to higher consumption of resources. We have realized that the economic success of a company also depends on the achievement of environmental goals.

As a manufacturing company, we therefore support developments that make a contribution to environmental protection. In doing so, we always pursue individual material flows along the value chain, because we see resources, product design, production and consumption as a whole.

With our environmental management system certified in accordance with DIN EN ISO 14001, we ensure that the required national and international requirements are complied with in all areas of the company and that the concept of environmental protection is practiced in all corporate processes. In addition, WAGO is pursuing further efforts in the field of environmental protection that go far beyond the requirements of ISO.

Some examples include the recycling of plastics, resource savings on product and packaging materials, the use of recycled paper throughout the company, the introduction of e-filling stations and the use of waste heat from production processes.

Product-Related Environmental Protection

Product-related environmental protection is an important part of sustainable environmental management at WAGO. Ensuring compliance with substance bans / restrictions worldwide, such as: As REACH, RoHS has a high priority.

RoHS – Restriction of the Use of Certain Hazardous Substances

It is an EC directive that regulates the use of certain hazardous substances in electrical and electronic equipment. In addition to reducing the harmful effects on humans and the environment, legislation aims to improve recycling possibilities. WAGO closely monitors the development regarding RoHS and reacts promptly to specifications accordingly. For more information about RoHS please contact us via ehs-product-compliance@wago.com.

RoHS 
Compliant

Success for Generations: Environmental Protection at WAGO

REACH – Registration, Evaluation and Authorisation of Chemicals

On 01.06.2007 the regulation (EC) no. 1907/2006 (REACH regulation) came into force and since then forms a valid legal basis for all EU member states. To protect human health and the environment, this EU Chemicals Regulation aims to classify and identify all chemicals, including their effects.

The REACH Regulation creates specific obligations for each actor in the supply chain. The products manufactured by WAGO are to be designated as products in the sense of the regulation. Since products are not subject to registration, WAGO usually assumes the role of the downstream user in the supply chain. WAGO therefore has an obligation to provide information along the supply chain in accordance with REACH Article 33. WAGO is naturally aware of this obligation.



For more information about our reporting requirements according to REACH Article 33 please visit our website "REACH SVHC Declaration" via www.wago.com/svhc

BOMcheck

European legislation such as REACH or RoHS requires the provision of information on restricted ingredients in products. This information must be shared by manufacturers and suppliers in the supply chain. WAGO meets this challenge in product-related environmental protection successfully and efficiently with BOMcheck.

BOMcheck is a centralized database for the declaration of ingredients. It is a compliance tool specifically designed to enable manufacturers and suppliers to produce their substance declarations under REACH, RoHS, and other restrictions on ingredients in an efficient and structured manner. This Internet database system increases data quality in the area of product-related environmental protection.

Further information on BOMcheck can be found at the following link: <http://www.bomcheck.net>

WEEE – Waste of Electrical and Electronic Equipment

The WEEE Directive 2012/19/EU regulates the take-back and recycling of electrical and electronic equipment. Manufacturers and importers of electrical and electronic equipment are obliged to register as a 'WEEE producer' and to comply with the reporting and take-back obligations. As a matter of course, we have taken compliance with legal WEEE requirements very seriously all the time - in our own interest as well as in the well-understood interest of our customers.

Only some of our products fall within the scope of the WEEE Directive and the Member State's implementation laws. These products are WEEE-compliant marked by us, as far as such a marking is legally required (which is not required for the B2B area Europe-wide).

For more information about WEEE please contact us via ehs-product-compliance@wago.com.

Less is More: Our Packaging

Recycling is the basis for choosing our packaging materials. All packaging used by WAGO can be recycled in the economic cycle without further pretreatment. In addition to the aspect of recycling, emphasis is placed on resource conservation. For this reason, our cardboard boxes consist of 80% recycled paper and are marked with the Resy symbol. The Resy symbol guarantees compliance with the Packaging Ordinance for transport packaging. The labeling is partly done by perforation. This process enables the colorless printing of WAGO cardboard boxes. This avoids unnecessary environmental pollution.

WAGO GmbH & Co. KG

Postfach 2880 · D · 32385 Minden
Hansastraße 27 · D · 32423 Minden

info@wago.com

www.wago.com

Headquarters	+49 571 887 - 0
Sales	+49 571 887 - 44222
Order Service	+49 571 887 - 44333

Current addresses at www.wago.com

WAGO is a registered trademark of WAGO Verwaltungsgesellschaft mbH.

"Copyright – WAGO GmbH & Co. KG – All rights reserved.

The content and structure of the WAGO websites, catalogs, videos and other WAGO media are subject to copyright. Distribution or modification to the contents of these pages and videos is prohibited. Furthermore, the content may neither be copied nor made available to third parties for commercial purposes. Also subject to copyright are the images and videos that were made available to WAGO GmbH & Co. KG by third parties."